



# Catalog Contents

## Introduction

- 1** Testers and Monitors
  - 2** pH
  - 3** ISE
  - 4** Titration
  - 5** Conductivity
  - 6** Dissolved Oxygen
  - 7** Multiparameter
  - 8** Magnetic Stirrers
  - 9** Chemical Test Kits
  - 10** Photometers
  - 11** Chemical Oxygen Demand (COD)
  - 12** Turbidity
  - 13** Refractometers
  - 14** Temperature, RH, and Lux
  - 15** Process Instrumentation
  - 16** Glossary
  - 17** Technical Tables
  - 18** Product Code Index
  - 19** Alphabetical Index
- Inside back cover: Warranty and Returns

# President's Message

January 2023

Dear Valued Customer:

I hope you will enjoy the latest version of our General Catalog - Volume 37.

Throughout our history, we have developed a tradition of excellence and evolution, continually releasing new and exciting products to the market as well as improving our existing products. This year is no exception. Our forward direction and emphasis on the future is evident in our new and improved products as well as our continuous updates to the Hanna Cloud and Hanna Lab App.

With constant innovation and world class support provided by our dedicated team worldwide we like to think we are in a class by ourselves and strive to prove it to our customers every day.

Our strategy to our customers is a simple one: provide products that are accurate, simple to use, and affordable with support that is knowledgeable, direct, and easy to obtain.

On behalf of the Hanna Instruments team worldwide, thank you for your continued and loyal support.



Martino Nardo  
President, Hanna Instruments





About Hanna ..... ii

- Production Overview.....ii
- History and Philosophy .....iii
- 360° Value..... iv
- What We Do.....v
- Hanna In-house Control..... vi
- Hanna Milestones ..... viii

Contacts .....xii

New Products ..... xvi



# Production Overview



## Hanna Design and Manufacturing

Since the introduction of its industrial science park located in Romania, Hanna has reached its target to produce all of its instrumentation in-house. The facility is equipped to support all phases of production such as product research and design, plastic injection molding, electronic assembly, glass blowing for electrodes, standards production and final assembly of product. Hanna oversees all aspects of its products from conception to the final quality check and packaging. Hanna is an ISO 9001:2015 certified company.

Our Woonsocket and Smithfield, RI facilities house our primary research and development centers and assemble select products such as titrators, spectrophotometers, ion selective electrodes and autosamplers.

In-house production affords Hanna the freedom to efficiently bring new and innovative products to market while continuously improving the quality and features of existing products.



## History

In 1978 Hanna Instruments was founded in Padova, Italy by Oscar and Anna Nardo. Since then, Hanna Instruments has grown to be a worldwide leader in the development of electro-analytical instrumentation. The development of novel instrumentation for customers that would not have normally used instrumentation is what has led to the success of the company.

In the 80's the company had a mission to provide a pH meter that was affordable, accurate and easy to use. The result was the pHep (pH electronic paper). This meter used an integrated circuit to measure the voltage response of a pH electrode packaged into a pocket-sized meter. The calibration of the meter was performed manually and the price was less than \$50.00. Having a simple operation and very affordable price point brought the advantages of an electro-analytical measurement of pH to the masses. Whether it be a farmer looking to measure the pH of soil or the printing press operator that needs to measure the pH of a fountain solution, Hanna Instruments provided the user with an accurate electronic alternative to litmus paper and chemical indicators.

Hanna Instruments has a history of developing innovative products that make analytical measurements easier to perform at an affordable price. Many innovations introduced by Hanna are now the norm for the instrumentation industry. Today, Hanna continues to set benchmarks for quality, innovative instrumentation.

Hanna Instruments is currently headed by Martino Nardo, son of Oscar and Anna Nardo. Under the direction of Martino Nardo, Hanna Instruments® continues to develop innovative and unique products. The most recent innovations include both the thinnest multiparameter meter in the market and pH sensors that incorporate Bluetooth Smart technology. edge® pH/EC/DO meter was launched in 2014 and is only 0.5" thick. edge uses digital sensors with a 3.5mm connector and to change from one parameter to the next all the user has to do is unplug and plug in a different sensor. Also in 2014, the HALO® pH electrode was released. This electrode is the first Bluetooth pH/temperature electrode. The HALO transmitted measurement data wirelessly to an iPad that was running the Hanna Lab App. In 2015, edge blu was released and it brought Bluetooth connectivity to a pH meter. Now the HALO can be used with a tablet style computer or a traditional pH meter. The HALO line of pH electrodes continues to be expanded to accommodate the diversity of applications. These Bluetooth enabled sensors are setting a new standard and it is safe to say that they will become commonplace in the future.

Being a leader in innovation is only part of our story. We are not only an instrumentation designer but also a vertically integrated manufacturer. From an original idea for a product to the finished good we are in control of the entire process. We employ our own engineers that design the circuits and program the firmware for the meters. We use surface mounted technology machines (SMT) to populate the circuit boards, injection molding machines to make the meter cases and other plastics, chemical manufacturing for solutions and reagents, glass blowers for the manufacture of pH and ORP electrodes, and even the printing of the packaging materials. Everything is done in-house. This ensures a high quality product while reducing the cost



Today, Hanna manufactures over 3,500 products in production facilities located in USA, Romania, Italy and Mauritius. We are proud to offer unique solutions for our customers. We continue to strive to understand the challenges that our customers are faced with in performing analytical measurements so that we can develop a solution that will provide a simplified and accurate way to measure.

by not outsourcing to third parties. Even more importantly, it allows for flexibility to produce short runs of products. Meaning that if the market demand for a particular product is very limited, we will still produce it because we know that there is a customer that requires a unique solution and not a general one size fits all type of product.

## Philosophy

The philosophy of the Nardo family has always been to supply customers around the world with practical, cost-effective solutions for their testing needs with world class service and support. This is the basis for the winning philosophy strongly embedded in Hanna.

For over four decades Hanna has prided itself in being an innovator of analytical instrumentation.

In 1984 Hanna developed the world's first microprocessor-based hand-held portable pH meter (HI8424) and our innovation continues to this day.

Hanna revolutionized the world of pH testing when it introduced the pHep® (pH Electronic Paper) pH tester in 1986. Millions of people were given the opportunity to test pH simply, accurately and affordably.

When Hanna introduced the world's first single parameter series of automatic titrators dedicated to food analysis in 2005, thousands of users from around the world were put in the position to improve the quality of their product by performing their own in-house analytical tests.

The same driving philosophy that has been a Hanna trademark for over four decades continues to this day.



# 360° Value

Introduction



about Hanna

## The Hanna Advantage

### A worldwide leader

With 60 offices in 47 countries, Hanna strives to be a worldwide leader in service and selection.

Offering research grade quality at competitive prices, every Hanna office strives to work with each customers to develop a solution tailored to their needs, on their budget.

### Quality

Our products are designed and manufactured under strict ISO 9001:2015 standards. Every instrument undergoes stringent quality control tests at different stages of manufacturing including 100% quality control checks just prior to shipment.

### Local support

After you have made your investment, you should never feel uncertain about the support or technical service you will receive. Hanna develops relationships with its customers built on quality products with personal service and support.

### Hanna 360° value

When you buy a Hanna product, you're not only buying the best value for your money, but you're also receiving the benefit of Hanna's unsurpassed customer service and post-sale technical support.

### Close to you

It is our policy to regularly participate in local trade shows and advertise our latest innovations in market specific magazines.

### 24/7 access

Visit us on the web at [www.hannainst.com](http://www.hannainst.com). There you can search for products, look up local office contacts, read the latest news from Hanna and download instruction manuals, MSDS and brochures.

### Certification

All Hanna products are in compliance with CE directives and our production facilities are ISO 9001:2015 certified.



## Industries We Serve

- Agriculture
- Aquaculture
- Aquariums and Pets
- Boilers and Cooling Towers
- Breweries
- Educational
- Environment
- Food and Dairy
- Greenhouses and Nurseries
- Hydroponics
- Industrial Processes
- Industrial Wastewater
- Quality Control Laboratories
- Municipal Drinking and Waste Water
- Plating
- Printing/Graphics
- Swimming Pools and Spas
- Water Conditioning
- Water Purification
- Wineries

## Products We Manufacture

- Chemical Test Kits
- Chemical Oxygen Demand
- Conductivity
- Dissolved Oxygen
- pH/ISE
- Titration
- Magnetic Stirrers
- Multiparameter Meters
- Photometers
- Relative Humidity
- Refractometers
- Temperature
- Turbidity
- Mini Controllers
- Process Instrumentation
- Electrodes
- Solutions
- Reagents
- Accessories



# Hanna In-house Control

Introduction

about Hanna

## Quality control

We believe in controlling the quality of our products from their inception to delivery. For this reason, we manufacture all the products we bring to the market including meters, electrodes, chemical reagents and buffer solutions. Each of our manufacturing facilities is specialized in a product family to ensure stability and greater quality.

Our engineers in manufacturing strive to achieve higher standards at all times, continuously investing in new manufacturing equipment and techniques. As a vertically integrated manufacturer, Hanna does not subcontract any part of the manufacturing process. From plastic molding to glass blowing and chemical bottling to PCB and electronic assemblies, Hanna controls the manufacturing process in-house.

All Hanna products are in compliance with international standards and our production facilities are ISO 9001 :2015 certified.



## Casing, injection, and rubber molding

Hanna designs and manufactures all of our instrument casings, custom cases and inserts, solution and reagent bottles and rubberized shockproof boots.



## Electronics

Our electronics department mounts and connects the electronic components onto our custom circuit boards. The boards are then tested and installed into our instruments.



## Glass blowing

Our glass blowing department combines artistry and science to create our electrodes. Glass is heated and shaped within strict tolerances by hand in both of our facilities in Nusfalau, Romania and Rhode Island, USA.



## Electrode assembly

Our glass blowing, injection molding and electronics department work together to supply our electrode assembly department with the materials they need to build Hanna electrodes.



## Labels and keypads

All of the masks, labels and pad printing for our instruments and solution bottles is designed, printed, and die-cut in-house.





## Assembly

Our assembly department finalizes the production of the instrument by putting all the components together to form a working instrument. This includes LCD's, probes, buttons.



## Packaging

Hanna produces the packaging for all product lines. The in-house control of all research, design and production steps provides continual quality control at all phases to assure the highest level of quality.



## Solutions

Our solutions are formulated and mixed on premises and are prepared to precise formulas and standardized with a pH electrode and meter calibrated to NIST standards.



## Manuals and literature

Our manuals and quick start guides are printed on our Heidelberg press as well as much of our leaflets, flyers, posters and catalogs.



## Reagents

Powder and liquid reagents are carefully formulated and filled to ensure maximum precision.



## Final quality check

After continuous validation and testing, Hanna products undergo a final quality check before they are packaged and released to consumers.



# Hanna Milestones

Introduction

about Hanna

## Hanna is Technology and Innovation

For over 40 years, Hanna has been a world leader in innovation of analytical instrumentation. Headed by our team at the home office in Woonsocket, Hanna's research and development department constantly challenge themselves to invent new testing techniques and to advance existing technology. The minds at Hanna work to achieve the common goal of simplifying analytical testing through improving instrumentation, sensor development, reagents and chemicals.

1978

### Hanna Opens in Italy

Hanna was founded in Padua, Italy.

1980

### World's first single-probe portable conductivity meter

The HI8033 is a four pole conductivity meter designed for soil testing in agriculture. The potentiometric probe allows measurements of different solutions with different conductivity values. The same meter can be used to measure both deionized water and fertilizer solution.

1982

### World's first pH controlled chemical dosing pump

The DP7916 combined a pH meter with a chemical dosing pump in order to maintain a desired set point of a process applications. The BL7916 is the second-generation design and is still widely used by many customers including plating, wastewater treatment, water treatment and swimming pools.

1984

### World's first microprocessor-based hand held pH meter

The HI8424 was the first portable microprocessor pH meter. The microprocessor allowed for automatic calibration as compared to manual calibration with trimmers or potentiometers. The calibration information was stored in the meter even when it was powered off.

1985

### World's first pH electrode with built-in temperature sensor

The HI8414 pH meter was the first meter to use a pH electrode (HI1213S) with a built in temperature sensor. The temperature sensor allowed for the automatic correction for changes in pH with changes in temperature as calculated by the Nernst equation. This advancement is now commonplace in the industry.



1986

### World's first electronic pocket sized pH tester

The pHep® or pH electronic paper revolutionized the way pH can be measured. This tester brought the electronic pH measurement to the masses. It allowed farmers, students, and many other users access to a pH meter that was simple to use and very accurate.

1988

### World's first pre-amplified pH electrode

Amphel was the first pH electrodes with a built in amplifier. The pH electrode produces a high impedance signal. Due to the low current signal the measurement is susceptible to electrical noise, humidity, and a bad connection. Utilizing an amplifier allowed for signal with a higher current, which overcame the measurement issues. We continue to use amplifiers in many electrodes including some of those with built in temperature sensors.

1990

### World's first waterproof portable pH meter

The HI9023 was the first waterproof portable pH meter. A pH measurement is usual for many industrial and environmental applications. In these situations it is common that a pH meter can get wet. If water or chemical solutions get inside the meter then it is possible that the sensitive electronics can be damaged. For this reason Hanna Instruments designed a meter that would be completely waterproof. The HI9023 and successive portables including the HI9024, HI9025 and HI9026 have been the work horse meter for many customers that need a rugged waterproof meter.

1991

## World's first replaceable electrode pH pocket tester

The Checker® 1 (HI98103) was the first pocket pH meter that had a replaceable electrode. The HI1270 pH electrode has a screw cap threaded end that was simple to replace extending the list of the pH meter. The Checker is by far the most popular and recognizable tester in the market with over 1 million meters used. The Checker is still in production and continues to be one of the most popular meters.

1992

## World's first portable pH meter with plain-paper printer

The HI9224 was the first portable pH meter with a built in printer. The addition of the printer to a meter was for the customers that required unalterable documentation. This is a great value for many industries including in the pharmaceutical and food industries.



1995

## World's first pocket thermometer with CAL Check™

The Checktemp® series of pocket thermometers were the first thermometers that incorporated a unique calibration check feature for determining any drift of the internal electronics. A switch is used to place the thermometer in CAL Check mode. If the reading was inside  $\pm 0.3^{\circ}\text{C}$  from  $0.0^{\circ}\text{C}$  reference point that is simulated then the internal electronics are within an acceptable tolerance.

1997

## World's first pH tester with double junction electrode

The pHel pH testers were the first pocket size meters with a double junction. Many industries have metals or other compounds that react and form a precipitate with silver ions from the silver chloride found in a single junction reference design. With a double junction electrode the silver chloride is located in an inner compartment while an outer compartment is silver free. This design extended the life of an electrode and was useful for customers that preferred the convenience of a tester with features of a traditional laboratory electrode.



1999

## World's first pH/temperature tester with dual-level LCD

The pHep®4 and 5 were the second generation of the original pHep. These meters used a large dual-level LCD that allowed many advance features that would only be found on more expensive portable and benchtop instrumentation. The Dual level LCD was able to display both pH and Temperature simultaneously along with a battery and stability indicators. The meters also feature automatic temperature compensation, automatic calibration, battery percent level at start up, waterproof, and a replaceable electrode. pHep 4 and 5 set the standard for all instrumentation manufacturers that offer handheld testers.



# Hanna Milestones



## 2000 World's first multiparameter (pH/conductivity/temperature) pocket tester

The Combo pH/EC/TDS/Temperature meters were the first testers to combine pH and conductivity sensors into a single meter. They offered all the features of the redesigned pHep handheld testers with the addition of a graphite amperometric sensor for the measurement of EC and TDS. The Combo meters also had a exposed temperature sensor that allowed for a quick and accurate temperature compensation for both pH and conductivity measurements.

## 2002 World's first colorimeter with CAL Check™ feature

The HI95 series of portable photometers were the second generation of our single parameter photometers. The HI93 series first generation meters used an LED at a specific wavelength as a light source. The HI95 series optical system was improved to use a tungsten lamp and narrow band interference filter for a much narrower spectral bandwidth. Hanna Instruments also incorporated a unique CAL Check function in which a traceable secondary standard is used to check the pre-programmed curve. If readings are outside a specified tolerance then the unit could be calibrated with the standards and an offset to the curve applied.

## 2003 World's first pH meter with CAL Check

Many problems in pH measurement result from a lack of understanding of the Nernstian response for a pH electrode. Every pH electrode generates a mV response in solutions at a specific pH. By monitoring the offset and slope characteristics of a pH electrode during the calibration process it is possible to determine potential problems. The pH221 and pH222 were the first pH meters to offer a unique CAL Check feature. During calibration these meters would alert the user if the probe needs to be cleaned or the buffer is contaminated. After calibration the probe condition (based on offset and slope) and the probe response were displayed with a five bar indicator. The greater the number of bars the better the condition and response.

## 2004 World's first process pH meter with integrated cellular communication

The ability for remote data acquisition is becoming of increasing importance. Many times it is convenient to monitor a process parameter remotely. With the HI504900 GSM module it is possible to use a SIM card from cellular provider to transmit measurement data over a cellular connection. The HI504 process pH/mV controller allows for the digital transmission of data by using an RS485 serial connection. The HI504 allows for programming responses based on measurement criteria. These responses include the use of sending a text (SMS) messages over the cellular connection.

## 2004 World's first pH/ORP combo tester

The measurement of pH and ORP is very common for industries that rely upon oxidizers for sanitization or to promote an oxidation reaction such as with the oxidation of cyanide to cyanate for the treatment of plating wastewater. Both pH and ORP measurements are also made for chemical reactions that use a reducing agent. The ORP generated by oxidizers and reductants are dependent on the pH of the solution. Many times there is enough oxidizer or reductant present but the pH is not at the optimum. With the HI98121 it is possible to monitor both pH and ORP at the same time. The HI98121 is commonly used to monitor pH and chlorine for many applications including swimming, food sanitization, plating wastewater treatment, and cooling tower water treatment.

## 2005 World's first single parameter line of auto titrators for wine testing

Total titratable acidity and sulfur dioxide are two important parameters that are measured during the wine making process. To measure these parameters either a pH/mV meter would be used with a volumetric burette or a very expensive and complex titration system is

used. Hanna Instruments developed the HI84100 (sulfur dioxide) and HI84102 (acidity) titrators for the wine industry. Both meters were inexpensive and simple to operate. All the chemistry used is premixed and the end point criteria pre-programmed. These meters allowed for the winemaker to perform analytical measurements without the need for sending samples to a lab.

2010

## World's first handheld colorimeters (Checker®HC) to offer ease of use and high accuracy in a palm sized design

The Checker HC handheld colorimeter series are the first single parameter colorimeters available in a convenient palm size design. Before the Checker HC colorimeters the user either used an expensive \$200-300 portable photometer or they used an inexpensive chemical test kit. The chemical test kits offer the advantage of being inexpensive but they do not provide the high degree of resolution or the non-subjective nature of a photometer. The Checker HC's provide the benefits of a colorimeter at a price point of a chemical test kit. The Checker HC's, like the pHep, are another prime example of Hanna Instruments bringing technology to people that would not normally think of using.

2013

## World's most innovative pH, EC and DO handheld/portable/wall-mount meter...edge®

edge is the thinnest multiparameter meter available. At just 0.5" thick the edge is loaded with many of the features found in expensive benchtop instrumentation. Features include data logging, USB ports, CAL Check™, auto ranging EC /TDS ranges, and GLP data review. edge uses digital pH, ORP, EC and DO probes with a small 3.5 mm connector. The edge is extremely versatile in that it can be used as a portable, benchtop or even as a wall mount indicator.

2014

## "World's first pH electrode with Bluetooth Smart technology (HALO®)

The HI11312 HALO is the world's first professional pH probe with Bluetooth Smart technology (Bluetooth 4.0). It is a high quality, double junction, refillable glass pH probe with a built-in temperature sensor that can be used virtually anywhere: in the field, laboratory or classroom. HALO transmits measurement data wirelessly to a compatible smart phone or tablet running the Hanna Lab App. Since the introduction of HALO in 2014 the family has grown to include other specialized electrodes including the FC2022 pH electrode for the measurement of pH in food products. Halo has set the new standard in technology for pH measurement that will be commonplace in the future.

2015

## World's first pH electrode and meter with Bluetooth Smart technology (HALO and edge blu)

The edge blu is the first Bluetooth enabled pH meter for the use with HALO Bluetooth pH electrodes. The edge blu receives measurement data wirelessly from the Halo pH electrode. The logging of data by the meter is performed by touching the HALO pH electrode button. The type of logging mode used is based on the setup configuration of edge blu. Data is logged at interval, on demand or by stability.

2016

## World's first colorimeter with tutorial mode

2017

## World's first pH and pump controller with smart electrode



2019

## First complete line of pH testers with application specific probes for the food and beverage industries.

2020

## World's first pH and pump controller with cloud connectivity and smart electrode



## Hanna Instruments® World Headquarters

### HANNA INSTRUMENTS, INC.

Highland Industrial Park,  
584 Park East Drive,  
Woonsocket, RI 02895 USA

P: (401) 765-0048  
E: [intsales@hannainst.com](mailto:intsales@hannainst.com)  
W: [www.hannainst.com](http://www.hannainst.com)

Hanna's headquarters is located in Woonsocket, Rhode Island, USA. This facility also houses our primary research and development center, global marketing and sales coordination and technical training facility.

### UNITED STATES

Hanna Instruments USA  
270 George Washington Highway,  
Smithfield, RI 02917  
P: (800) 426-6287  
F: (401) 765-7575  
E: [sales@hannainst.com](mailto:sales@hannainst.com)  
W: [www.hannainst.com](http://www.hannainst.com)

Primary sales and technical  
service office for the USA.



## ALBANIA

Hanna Instruments Albania Sh.p.k.  
Rr. Frosina Plaku, Pallati 21, Ap. 1  
1023 Tirana, Albania  
P: +355 4 562 8370  
E: info@hannainstruments.al  
W: www.hannainstruments.al

## ARGENTINA

Hanna Instruments Argentina s.a.  
Saavedra 1023 (C 1229 ACK), Buenos Aires  
P: (11) 4308.1905/4308.4807  
F: (11) 4308.1904  
E: ventas@hannaarg.com  
W: www.hannaarg.com

## AUSTRALIA

Hanna Instruments Australia  
18 Fiveways Boulevard  
Keysborough Victoria 3173  
P: (03) 9769 0666  
F: (03) 9769 0699  
E: sales@hannainst.com.au  
W: www.hannainst.com.au

## AUSTRIA

Hanna Instruments Österreich GmbH  
Rosenkranzgasse 6, 8020 Graz, Austria  
P: +43 (0) 316 72 00 29  
E: info@hannainstruments.at  
W: www.hannainstruments.at

## BANGLADESH

Hanna Instruments Bangladesh  
Road# 2, Block# L, House# 14/A,  
Banani, Dhaka, Bangladesh  
P: +88 02 55040662  
E: sales@hannainst.com.bd  
W: www.hannainst.com.bd

## BELGIUM

Hanna Instruments BV  
Winninglaan 8, 9140 Temse  
P: +32 3 710 93 40  
F: +32 3 710 93 59  
E: info@hannainstruments.be  
W: www.hannainstruments.be

## BOLIVIA

Hanna Instruments Bolivia  
Av. Banzer Km 6 1/2, Edificio Arysta  
Santa Cruz  
P: (591 3) 3120130 / 3116969  
E: ventas@hannabolivia.com  
W: www.hannabolivia.com

## BRAZIL

HANNA instruments Brasil importação e  
exportação LTDA.  
Alameda Juari, 539, Tamboré Barueri -  
SP06460-090  
P. 55 (11) 20765080  
E: vendas@hannainst.com.br  
W: www.hannainst.com.br

## CANADA

Hanna Instruments Canada Inc.  
3156 Industriel  
Laval, Quebec, H7L 4P7  
P: (450) 629.1444  
E: info@hannacan.com  
W: www.hannacan.com

## CHILE

Hanna Instruments Equipos Ltda.  
Lo Echevers 311, Quilicura  
Santiago  
P: (56 2) 28625700  
E: ventas@hannachile.com  
W: www.hannachile.com

## CHINA

Hanna World Instruments (Beijing) Co.,Ltd  
Room 911, Building C,Webok Time Center,  
Yard No.17 Zhongguancun South St.,  
Haidian Dist., Beijing 100081  
P: (86) 10 8857 0068/8857 0069  
E: china@hannainst.cn  
W: www.hannainst.cn

## COLOMBIA

Hanna Instruments Colombia  
Carrera 98 # 25G-10 Bodega 9, Bogotá  
P: (571) 5189995  
E: ventas@hannacolombia.com  
W: www.hannacolombia.com

## COSTA RICA

Pavas, Rohrmoser, Costado Este de Centro  
Comercial Plaza Mayor.  
Plaza Amatista Local #1.  
San José  
P: 00 (506) 2296 5368  
E: hannacostarica@hannainst.cr  
W: www.hannainst.cr

## CROATIA

Hanna Instruments d.o.o  
Jure Kaštelana 19, 10 000  
Zagreb  
P: +385 12446721  
E: sales2@hannainst.hr  
W: www.hannainst.hr

## CZECH REPUBLIC

Hanna Instruments Czech s.r.o.  
Mezi vodami 1903/17a  
143 00 Praha 4  
P: +420 244 401 144  
E: info@hanna-instruments.cz  
W: www.hanna-instruments.cz



# Hanna Instruments® Offices Worldwide

Introduction

contacts

## ECUADOR

HANNA Instruments Ecuador S.A.  
Avenida Plaza Dañin y Miguel Alcívar MZ#25  
solar #4 de la ciudadela Albatros, Parróquia  
urbana Tarqui.  
P: (593-2) 601 6989  
E: hannaecuador@hannainst.ec  
W: www.hannainst.ec

## FRANCE

Hanna Instruments France  
Parc d'activités des Tanneries, 1 rue du Tanin,  
BP133, 67380 TANNERIES CEDEX  
P: +33 3 88 76 91 88  
F: +33 (0) 3 88 76 58 80  
E: info@hannainstruments.fr  
W: www.hannainstruments.fr

## GERMANY

Hanna Instruments Deutschland GmbH  
An der Alten Ziegelei 7, Voehringen, Baden-  
Wuerttemberg, 89269  
P: +49 7306 3579100  
F: +49 7306 3579101  
E: info@hannainst.de  
W: www.hannainst.de

## GREECE

Hanna Instruments Hellas Ltd.  
Marni 10, 10433 Athens  
P: 210 8235192 / (+30) 210 8227825  
E: hannainfo@hannagreece.gr  
W: www.hannagreece.gr

## GUATEMALA

7 calle 3-24 Zona 18 Ofiespacio 101  
Interbodegas, Guatemala Guatemala  
P: (502) 2316-7574  
E: hannaguatemala@hannainst.com.gt  
W: www.hannainst.com.gt

## HUNGARY

Hanna Instruments Service KFT  
Alsó-kikötő sor 11.C, Szeged, H-6726  
P: +36 30 453 7854  
F: +36 62/541-035  
E: sales@hih.hu  
W: www.hannainst.hu

## INDIA

Hanna Equipments (India) Pvt. Ltd.  
3,4,5,6 First floor, AumSai Building, Plot  
No. 23C, Sector-7, Kharghar, Navi Mumbai-  
410210, Maharashtra  
P: +91 22 27746554/55/56  
F: +91 22 2774 6557  
E: sales@hannainst.in  
W: www.hannainst.in

## INDONESIA

PT. Hanna Instruments Indotama  
Perkantoran Plaza Pasifik,  
Jl. Raya Barat Boulevard Blok A4 no 86  
Kelapa Gading Permai - Jakarta Utara 14240  
P: 021 4525106  
E: hannastruments.indotama@gmail.com

## ITALY

Hanna Instruments Italia Srl  
Viale Delle Industrie, 11, Ronchi di Villafranca  
Padovana, PD, 35010  
P: +39 0499070367  
E: padova@hanna.it  
W: www.hanna.it

## JAPAN

Hanna Instruments Japan Corporation  
M BAYPOINT MAKUHARI 14F-EN, 1-6 Nakase,  
Mihama-ku, Chiba 261-0023  
P: +81 43 216 2601  
F: +81 43 216 2602  
E: sales@hanna.co.jp  
W: www.hanna.co.jp

## KOREA

Hanna Instruments Korea  
134 HYUNDAI TREBIEN BUILDING,  
DONHWAMUN-RO, 11GA-GIL, JONGNO-GU,  
SEOUL, 03132  
P: (82) 02-743-5147  
E: mccoynhan@naver.com  
W: www.hannainst.co.kr

## LITHUANIA

JSV Hanna Instruments Baltics  
Suderves str. 8i, Avizieniai,  
Vilnius district LT14192, Lithuania  
P: 37065573111  
e: office@hannainst.lt  
W: www.hannainst.lt

## MALAYSIA

Hanna Instruments (M) SDN BHD  
No. 11A, Jalan PJS 11/20, Bandar Sunway  
46150 Petaling Jaya, Selangor  
P: (603) 5638 9940  
F: (603) 5638 9829  
E: sales@hannamalaysia.com  
W: www.hannamalaysia.com

## MEXICO

Hannapro S.A. de C.V.  
VAINILLA 462 COLONIA GRANJAS MEXICO,  
DEL. IZTACALCO, MEXICO D.F., 08400  
P: 52 55 56491185  
E: hannapro@prodigy.net.mx  
W: www.hannainst.com.mx

## MOROCCO

Hanna Instruments Morocco S.a.r.l.  
R.te Nationale 10, km 3.5 Ben Sergao - Agadir  
P: +212 528 28 35 35  
F: +212 5 28 28 32 31  
E: vente@hannamaroc.com  
W: www.hannamaroc.com





## THE NETHERLANDS

Hanna Instruments BV  
Betuwehaven 6  
3433 PV Nieuwegein,  
P: 0031 302 89 68 42  
F: +31 30-267 14 27  
E: info@hannainstruments.nl  
W: www.hannainstruments.nl

## ROMANIA

Hanna Instruments Romania SRL  
Str Heltaï Gaspar, nr 9A, Cluj Napoca,  
Cluj, 400427  
P: +40 264 599 459  
F: +40 264 598 740  
E: info@hannainst.ro  
W: www.hannainst.ro

## SLOVENIA

Hanna Service doo  
Sermin 75H, Bertoki – 6000 Koper  
P: 00386 (0) 59029902/3  
E: sales@hannaservice.eu  
W: www.hannaservice.si

## SWEDEN

Hanna Norden AB  
Energigatan 15B, 434 37 Kungsbacka  
P: +46 (0) 300 404018  
E: info@hannanorden.com  
W: www.hannanorden.com

## UNITED ARAB EMIRATES

Hanna Instruments FZE  
F-10 Gate 4 Ajman Free Zone Ajman UAE PO  
Box 5197  
P: 97167406681  
E: info@hannainst.ae  
W: www.hannainst.ae

## POLAND

Hanna Instruments Polska  
AL.J.PIŁSUDSKIEGO 73, 10-449 OLSZTYN,  
POLSKA  
P: 48 895390961  
F: 0048895390963  
E: info@hanna-polska.com  
W: www.hanna-polska.com

## SERBIA

Hanna Instruments d.o.o  
Palmotičeva 20a, Beograd, Srbija  
P: +381 61 2036 045  
E: info@hannainstruments.rs  
W: www.hannainstruments.rs

## SOUTH AFRICA

Hanna Instruments (Pty) Ltd  
66 Vernon Road, Bedfordview, Morninghill,  
Johannesburg, South Africa, 2007  
P: +27 011 615 6076  
F: 0864517612  
E: hanna@hanna.co.za  
W: www.hanna.co.za

## TAIWAN

Hanna Instruments Taiwan Ltd.  
3F., No. 56, Ln. 188, Ruiguang Rd., Neihu Dist.,  
Taipei City 114062, Taiwan (R.O.C.)  
P: +886 2 8797 2918  
E: anna@hannainst.com.tw  
W: www.hannainst.com.tw

## UNITED KINGDOM

Hanna Instruments Ltd  
Eden Way, Pages Industrial Park  
Leighton Buzzard, Bedfordshire LU7 4AD  
P: 01525 850855  
E: sales@hannainstruments.co.uk  
W: www.hannainstruments.co.uk

## PORTUGAL

Hanna Instruments Portugal LDA.  
Zona Industrial de Amorim  
Rua Manuel Dias, n.º 392, Fração I  
4495-129 Amorim - Póvoa de Varzim  
P: +351 252 248 670  
F: +351 252 248 679  
E: info@hanna.pt  
W: www.hanna.pt

## SINGAPORE

Hanna Instruments (S) Pte. Ltd  
21 Kallang Avenue #04-177 Singapore  
339412  
P: (65)6296-7118  
E: sales@hannasingapore.com  
W: www.shop.hannasingapore.com

## SPAIN

Hanna Instruments S.L.  
Poligono Industrial de Azitain PARCELA 3d,  
EIBAR, GUIPUZCOA, 20600  
P: 34943820100  
F: 943820245  
E: info@hanna.es  
W: www.hannainst.es

## THAILAND

Hanna Instruments Thailand Ltd  
410/67-68 Soi Ratchadapisek 24,  
Ratchadapisek Road, Samsen Nork,  
Huay Kwang, Bangkok 10310  
P: (66)25414199  
F: 0-2541-4198  
E: sales@hannathai.com  
W: www.hannathai.com

## VIETNAM

Hanna Instruments Vietnam  
5th Floor, 208 Nguyen Trai,  
Pham Ngu Lao Ward, District I  
Hochiminh City  
P: 84-8-39260457/58/59  
E: sales.hcm@hannavietnam.com  
W: www.hannavietnam.com

# Our Most Advanced Benchtop Meters

3 Models Available

New



Users can select between five different views on the 7-inch capacitive touch screen with multi-touch support. User accounts can be easily created and managed.



Basic View



Simple GLP View



Full GLP View

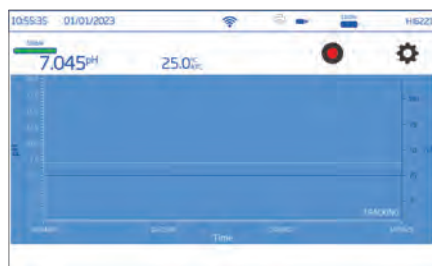

Graph View

pH	mV	T(°C)	Time	Date	Notes
7044	-2.4	25.0	105713	08/09/2022	
7044	-2.4	25.0	105712	08/09/2022	
7044	-2.4	25.0	105711	08/09/2022	
7044	-2.4	25.0	105710	08/09/2022	
7044	-2.4	25.0	105709	08/09/2022	
7045	-2.4	25.0	105708	08/09/2022	
7045	-2.4	25.0	105707	08/09/2022	
7045	-2.4	25.0	105706	08/09/2022	
7045	-2.4	25.0	105705	08/09/2022	
7045	-2.4	25.0	105704	08/09/2022	
7045	-2.4	25.0	105703	08/09/2022	

Table View

These systems respond to a complex range of measurement and monitoring requirements, providing accuracy, reproducibility, and reliability.



New

HI6221

## Advanced pH/ORP Meter

*pH/ORP and Temperature*

HI6221 is Hanna's advanced benchtop pH meter with a large touch screen display and streamlined design.

Supplied complete to start taking measurements, the HI6221 includes Hanna's HI1131B refillable pH electrode and HI7662-TW stainless steel temperature probe.

- Measure pH/mV (pH) or mV/Rel.mV (ORP) with temperature

See page 2.8



HI6321

## Advanced Conductivity Meter

*Conductivity/Resistivity/TDS/Salinity/Temperature*

HI6321 is a streamlined benchtop meter with a large touch screen display, comprised of a housing and an integrated conductivity measurement module.

Compact and easy to operate, the HI6321 includes Hanna's HI7631233 four-ring conductivity/resistivity/TDS/salinity probe.

- Measure  $\mu\text{S}/\text{cm}$ ,  $\text{mS}/\text{cm}$  (Conductivity);  $\Omega\cdot\text{cm}$ ,  $\text{k}\Omega\cdot\text{cm}$ ,  $\text{M}\Omega\cdot\text{cm}$  (Resistivity); ppm, ppt (TDS); ppt, PSU, % (Salinity) with temperature

See page 5.6



HI6421 • HI6421P

## Advanced Dissolved Oxygen Meters

*with Optical and Polarographic Probe Compatibility*

HI6421 and HI6421P are streamlined benchtop meters with a large touch screen display, comprised of a housing and an integrated module designed for fresh and saltwater measurements of dissolved oxygen.

Compact and easy to operate, HI6421 includes the HI7641133 optical dissolved oxygen probe (opdo®). The probe is fitted with easy to use Smart Caps that contain pre-loaded calibration coefficients that are automatically transmitted to the probe.

HI6421P includes the HI764833 polarographic probe. The slim design allows for convenient measurement in test tubes and Biological Oxygen Demand (BOD) bottles.

- Measure %Sat, mg/L, ppm (DO); mg/L, ppm (BOD); mg/L (OUR); ppm, mg/L (SOUR)

See page 6.4





New



IP67  
waterproof



Hanna Lab App  
Compatible

HI97115

## Marine Master Waterproof Wireless Multiparameter Photometer

Measure pH, Alkalinity, Ammonia, Calcium, Magnesium, Nitrate LR, Nitrate HR, Nitrite ULR, and Phosphate ULR

The HI97115 is a compact and versatile Marine multiparameter photometer designed to accurately determine pH, Alkalinity, Ammonia, Calcium, Magnesium, Nitrate, Nitrite, and Phosphate levels in aquariums and marine biology applications. The HI97115 is suitable for field and bench measurements.

The HI97115 can be used as a stand-alone photometer or can be connected to the Hanna Lab App with a compatible smart device via the integrated Bluetooth® module. When connected, Hanna Lab App functions include measurement with the ability to add notes, data logging with extended storage capacity, data sharing, and the ability to create and save method groups.

See page 10.88

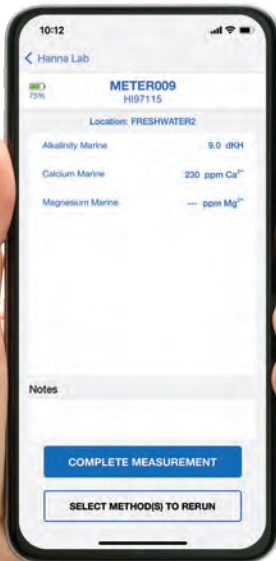



HI981520

## Marine Monitor

*pH, Marine Salinity, and Temperature*

Testing and monitoring salinity in saltwater aquariums is an ongoing task. The HI981520 is an easy to use vertical mount unit that continuously monitors and displays conductivity and pH. Seawater salinity is expressed in either parts per thousand (ppt), Practical Salinity Units (PSU), or Specific Gravity (S.G.).

A high/low alarm can be configured for each parameter and the results are displayed on a large, easy to read LCD.

[See page 1.62](#)

New



HI97105

## Marine Master Waterproof Multiparameter Photometer

*Measure pH, Alkalinity, Ammonia, Calcium, Magnesium, Nitrate LR, Nitrate HR, Nitrite ULR, and Phosphate ULR*

The HI97105 is a compact and versatile Marine multiparameter photometer designed to accurately determine pH, Alkalinity, Ammonia, Calcium, Magnesium, Nitrate, Nitrite, and Phosphate levels in aquariums and marine biology applications. The HI97105 consolidates testing needs into one unit using the same reagents.

[See page 10.92](#)



Updated



New



HI520-0540

HI520

## Dual-Channel Universal Process Controller

- Waterproof IP65 (NEMA 4X) enclosure
- Large backlit LCD
- Multi-color LED status indicators
- Audible alarm
- Tactile rubberized keypad
- Universal mounting
- Universal Hanna digital probe

HI520 is Hanna's first dual-input process controller that accepts virtually any combination of compatible probes. Designed to adapt to unique process control requirements, users have the option to enable or disable each channel independently.

The HI520 advanced process controller can be configured for applications requiring digital monitoring and/or control of four main water-analysis parameters: pH, ORP, Conductivity, and Dissolved Oxygen.

Additionally, this controller features digital probe inputs that automatically detects and updates the controller with the parameter that it measures.

[See page 15.48](#)



HI520-0320



HI98319

## Low and High Range Salinity Tester

- Measure low (0.00 to 10.00 ppt) and high (0.0 to 70.0 ppt) range
- Salinity results are displayed in either parts per thousand (ppt), Practical Salinity Units (PSU), or Specific Gravity (SG)
- Waterproof
- Automatic temperature compensation (ATC)
- Dual pin graphite EC probe

The HI98319 is a compact, waterproof, pocket-sized marine Salinity tester designed for the measurement of salinity in salt water aquariums, aquaculture, brackish water, or other salt-water bodies.

Salinity results are displayed in either parts per thousand (ppt), Practical Salinity Units (PSU), or Specific Gravity (SG).

[See page 1.37](#)



HI98325

## Low and High Range Salinity Tester

- Measure low (0.00 to 10.00 ppt) and high (0.0 to 70.0 ppt) range
- Salinity results are displayed in either parts per thousand (ppt), Practical Salinity Units (PSU), or Specific Gravity (SG) Waterproof
- Waterproof
- Automatic temperature compensation (ATC)
- Dual pin graphite EC probe

The HI98325 is a compact, waterproof, pocket-sized, salinity tester designed to measure salinity levels in irrigation water.

This tester is the ideal tool in agricultural areas where level salinity values are vital to crop management such as coffee farms, orange farms, watermelon farms, tea and rice farms. Additionally, the HI98325 is useful in other industries where low level salinity values are needed including printing, textiles, food and beverages as well as research and environmental protection institutes.

[See page 1.38](#)



## DiST®9

HI98326

## Low and High Range Salinity Tester

- Measure low (0.00 to 10.00 ppt) and high (0.0 to 70.0 ppt) range
- Salinity results are displayed in either parts per thousand (ppt), Practical Salinity Units (PSU), or Specific Gravity (SG)
- Waterproof
- Automatic temperature compensation (ATC)
- Dual pin graphite EC probe

The HI98326 (DiST 9) is a compact, waterproof, pocket-sized Salinity tester designed for the measurement of salinity in salt water aquariums, aquaculture, brackish water, or other salt-water bodies.

[See page 1.39](#)



# New Marine Line Checker®HC's

New



HI783

## Marine Magnesium

Handheld Colorimeter

The HI783 Marine Magnesium Checker®HC is a handheld colorimeter that uses the Beer-Lambert principle to determine the concentration of magnesium colorimetrically. The HI783 is designed specifically to measure magnesium levels in a saltwater aquarium or in marine biology applications. The 1000 to 1800 ppm range is ideal for coral/fish or fish-only aquarium maintenance.

[See page 10.133](#)



HI784

## Marine Ammonia

Handheld Colorimeter

The HI784 Marine Ammonia Checker®HC is a handheld colorimeter that uses the Beer-Lambert principle to determine the concentration of ammonia colorimetrically. The HI784 is designed specifically to measure ammonia levels in a saltwater aquarium. The 0.00 to 2.50 ppm range is ideal for coral/fish or fish-only aquarium maintenance.

[See page 10.124](#)





HI9810452

# HALO2



## Wireless pH Tester for Meat

*with built-in specialized electrode*

Accurate and easy to use, this HALO2 Wireless pH Tester for Meat is ideal for pH measurement during meat processing. This tester can be used as a stand-alone pH tester or can be connected to the Hanna Lab App.

HI9810452 features threads at the base of the probe for compatibility with the FC097 stainless steel meat blade (optional accessory).

[See page 2.54](#)



HI9810452  
FC097 meat blade  
compatible

HI9810452 with  
FC097 meat  
blade attached



HI981045 with  
FC097 meat  
blade attached

HI981045  
FC097 meat blade  
compatible

## Foodcare

HI981045

## Meat pH Tester

*with specialized probe*

HI981045 Foodcare Meat pH tester is an application specific designed pH tester for the measurement of pH during meat processing. HI981045 features threads at the base of the probe for compatibility with the FC097 stainless steel meat blade (optional accessory).

[See page 1.28](#)



New



New



### Removable vial adapter

The vial adapter can be removed to accommodate CAL Check™ cuvettes for validation.



HI97106

## Chemical Oxygen Demand Portable Photometer

*Low, Medium, High, Ultra High Range*

The HI97106 is a waterproof, portable photometer with an advanced optical system designed to accurately determine chemical oxygen demand (COD).

With the CAL Check™ functionality, users are able to validate instrument performance at any time. Hanna Instruments® CAL Check cuvettes are certified against NIST-traceable reference instrument(s).

The built-in tutorial mode guides users step-by-step through the measurement process. The tutorial mode includes all steps required for sample preparation, the required reagents and quantities.

[See page 11.20](#)



HI93754

## COD Certified Standards and Reagents

- New packaging with procedure guide on the inside lid
- Compact packaging
  - Each set of COD vials is stored in fully recyclable, sustainable, compact plastic packaging rather than standard styrofoam. A smaller box allows you to store more on your shelf, and reduce waste when disposing of your packaging.

See page 11.22



HI96785-25

## Cationic Surfactants

(13 mm vial)

13 mm vial designed for use in the HI801 iris® Spectrophotometer, HI83399 COD Meter and HI83314 COD Meter for wastewater analysis.

- 0.00 to 2.50 mg/L (as CTAB)
- Reagents for 25 tests

See page 10.19



HI96786-25

## Iron

(13 mm vial)

13 mm vial designed for use in the HI801 iris Spectrophotometer, HI83399 COD Meter and HI83314 COD Meter for wastewater analysis.

- 0.00 to 6.00 mg/L (as Fe)
- Reagents for 25 tests

See page 10.17

Updated



New

## EC and TDS Mini Controllers with 4-20 mA galvanic isolated output

- Models available with 4-20 mA galvanic isolated output with external dosing disable contact
- Large Clear LCD
- Fire Retardant Casing
- Splash-Resistant Cover

Starts on page 15.78

## pH Electrode Protective Sleeves

The Hanna pH electrode protective sleeve helps to prevent accidental damage to the glass bulb from stirrers, accidentally dropping electrodes into a beaker/vessel, and general field use. Designed to be used with Hanna 12 mm DIA glass spherical and conical tip electrodes including the 12 mm electrodes on certain HALO®, HALO2 and HI9810XX models. This sleeve also works with 12 mm DIA half cells, reference electrodes and FC300B ISE.

See page 2.158

HI839800

## COD Test Tube Heater

with 25 Vial Capacity

The HI839800 thermo-reactor is made of sturdy materials and has a vial capacity of up to 25 simultaneous digestions.

A built-in countdown timer of up to 180 minutes is included for applications that require timed digestions. When this feature is enabled, a beep is heard and the heating element turns off at the end of the set time period.

Additionally, the reactor is set up with 3 predefined temperature programs that can be selected at the press of a button:

- 105 °C for total nitrogen digestion
- 150 °C for COD and total phosphorous reactions
- 170 °C for rapid method digestion

See page 11.24

Updated





**Introduction.....1.2**

- Product Spotlights.....1.4
- Comparison Guide .....1.6

**Testers..... 1.8**

- Multiparameter .....1.8
  - GroLine®.....1.10
  - Pool Line.....1.12
- pH.....1.14
  - Pool Line.....1.16, 1.18, 1.22
  - GroLine.....1.19, 1.23
  - Soil.....1.24
  - Milk .....1.25
  - Cheese.....1.26
  - Sushi.....1.27
  - Meat.....1.28
  - Bread & Dough .....1.29
  - Chocolate .....1.30
  - Wine .....1.31
  - Beer .....1.32
  - Skin & Scalp .....1.33

- pH/ORP & ORP .....1.34
  - Pool Line .....1.36
- Salinity.....1.37
  - Marine Line.....1.37
  - GroLine.....1.38
- Conductivity/TDS.....1.44
  - Pool Line.....1.46, 1.42
  - GroLine.....1.43, 1.45
- Water Purity.....1.47
- Temperature.....1.50

**Monitors .....1.54**

- Multiparameter .....1.54
  - GroLine.....1.54
  - Marine Line.....1.62
- Temperature.....1.66

**Replacement Electrodes .....1.68**



## Laboratory Accuracy in the Field

In the past, measuring and monitoring important parameters was limited to the laboratory. Now, these parameters are being tested right in the field for applications such as environmental study, agriculture, the food industry, horticulture, wastewater management, fish farming, water quality maintenance, and anywhere quality and accuracy is important. Hanna has developed a large variety of testers and monitors designed to fulfill the requirements of virtually any application.

Hanna offers a vast selection of single and multiparameter testers which cover a multitude of the most important parameters: pH, ORP, conductivity (EC), total dissolved solids (TDS), temperature and salt.

Testers can perform on the spot measurements quickly, accurately, and inexpensively. They allow users with different backgrounds and technical training to make readings without the need of a laboratory or having to purchase expensive and complex analytical equipment.

Hanna provides high accuracy in a single parameter tester for pH, EC, TDS, temperature, and more. Multiparameter testers are also available, eliminating the hassle of carrying multiple testers.

Hanna testers have easy to read LCDs and durable outer casings. They are able to measure in places with a high percentage of humidity, and low power demand allows a long battery life, eliminating the need for frequent battery replacement.

## pH Testers

All Hanna pH testers come with a replaceable pH probe, which is a unique advantage over most pH testers found on the market today.

Testers feature Automatic Temperature Compensation (ATC) and calibration at one or two points. Designed to be pocket sized with a narrow tip, they are ideal for measurements in smaller samples.

## Conductivity Testers

Conductivity (EC) testers are widely used for monitoring EC/TDS with water conditioning, reverse osmosis, cooling towers, drinking water, wastewater, laboratories, agriculture, aquaculture and aquariums, hydroponics, and the printing industry.

With selectable or fixed conversion factors to relate to EC and TDS, readings can be more accurate. Hanna conductivity testers feature an amperometric graphite probe that provides greater accuracy and repeatability in measurements because it cannot be contaminated by salt deposits in solutions. Calibration of conductivity testers is simple and can be done manually or automatically with a single point.

Measurements are automatically temperature compensated to ensure correct readings.

## Salt and Water Purity Testers

The waterproof Marine Line salinity tester can help you monitor the concentration of dissolved salts in saltwater aquariums. It is often the first water parameter many aquarists test for as it is crucial in making artificial seawater.

Water purity testers enable users to check the purity of distilled or demineralized water in environments such as printed circuit board washing, laundry, steam cleaning, and all areas where pure water is used. The measurement for salt and water purity is conductometric.

## Thermometers

Hanna's thermometers feature a unique CAL Check™ function to ensure accurate measurements every time. Hanna temperature sensors allow users to take measurements with extremely high accuracy in a short amount of time. The sharp tip of the probes can easily penetrate semi-solid products, making routine controls simple and quick. These testers are ideal meters for measuring temperature according to HACCP requirements.

## Hanna GroLine Monitors

Hanna GroLine monitors are an ideal solution in applications where constant monitoring of a stationary sample such as fertilizer solution is required. These multiparameter monitors allow the user to monitor pH, EC, TDS, and Temperature with one probe..

Ideal for hydroponics, greenhouses, horticulture, two versions are offered, one supplied with an inline probe and one supplied with a standard combination probe.

### 24/7 Monitoring

These GroLine Monitors provide 24 hour continuous monitoring of pH, conductivity (EC or TDS), and temperature in hydroponic nutrients. Quick to setup and simple to use, these monitors were designed with hydroponics, aquaponics, and greenhouses in mind.

### Instantly See All Measurements

The versatile display of the Monitors allows for three screen modes. The LCD can display all three essential hydroponic nutrients measurements at one time, a 3-second cycle of single measurements, or a real-time graph screen with options for measurement selection and log recall.

### Monitor Changes Over Time

Fluctuations in your hydroponic nutrient solution can have lasting effects on your plants. These Monitors automatically log every 15 minutes for the last 30 days, and stores min, max, and average values so you can recognize when patterns arise and help prevent future problems. For review and storage, use the USB-C to easily transfer data to a flash drive or PC using a cable. Files are exported as .csv.

### Grow With Confidence

GroLine Monitors free up your time by doing the testing for you. Simply set high and low alarm levels - if your hydroponic nutrient solution moves out of range a measurement error will display. A quick look at the large display will let you know if your nutrient solution needs adjusting.

### Inline Probe

The supplied HI1285-9 multiparameter probe for GroLine monitor model HI981421 measures pH, EC, and temperature in one convenient, rugged probe. A solid-state preamplifier is integrated into the probe to protect the pH measurement from transient electrical noise.

### Simpler with a combination probe

The HI1285-8 for GroLine monitor model HI981420 is a 3-in-1 pre-amplified combination probe. This probe is built to be durable and features two graphite sensors for reliable conductivity readings. A built-in temperature sensor ensures fast, accurately compensated readings even during sudden temperature fluctuations.

## Temperature Monitors

Few manufacturers have given any thought to providing users with a convenient way of monitoring temperature conditions in catering, refrigerators, and other places that need quick monitoring. Hanna's precision thermometers can be mounted right over the samples to be measured or placed in refrigerators for continuous readings of cold storage products.

Temperature monitors come with Hanna's exclusive CAL Check™ feature. With CAL Check, users can ensure the accuracy of the meter without the need for external calibration equipment.

Food grade stainless steel probes and quick response times assure the safety and preservation of the goods monitored.





HI981520

## Marine Monitor

*pH, Marine Salinity, and Temperature*

Testing and monitoring salinity in saltwater aquariums is an ongoing task.

The HI981520 is an easy to use vertical mount unit that continuously monitors and displays conductivity and pH.

[See page page 1.62](#)



HI981421

## GroLine® Hydroponics Monitor

*with inline multiparameter probe*

The HI981421 GroLine Monitor provides 24 hour continuous monitoring of pH, conductivity (EC or TDS), and temperature in hydroponic nutrients. Quick to setup and simple to use, this monitor was designed with Hydroponics, Aquaponics, and Greenhouses in mind. Make your nutrient solution easy to manage with the GroLine Monitor and combined pH/EC/Temperature probe.

[See page 1.54](#)





HI98319

## Low and High Range Salinity Tester

The HI98319 is a compact, waterproof, pocket-sized marine Salinity tester designed for the measurement of salinity in salt water aquariums, aquaculture, brackish water, or other salt-water bodies.

See Page1.37



HI98325

## Low and High Range Salinity Tester

The HI98325 is a compact, waterproof, pocket-sized, salinity tester designed to measure salinity levels in irrigation water.

See Page1.38



## DiST 9

HI98326

## Low and High Range Salinity Tester

The HI98326 (DiST 9) is a compact, waterproof, pocket-sized Salinity tester designed for the measurement of salinity in salt water aquariums, aquaculture, brackish water, or other salt-water bodies.

See Page1.39



HI981074

## pH Tester

See page 1.18



HI983024 • HI983044

## TDS and EC Testers

See page 1.46



HI985394

## Digital Thermometer

See page 1.52

Code	pH Range	EC Range	TDS Range	ORP Range	Salinity Range	Temperature Range(s)	0.01 pH Resolution	Automatic Calibration	Automatic EC Calibration	pH Calibration Points	EC/TDS Calibration Points	Quick Cal Calibration Solution Compatible	pH Buffer Sets	ATC	Waterproof	Replaceable Electrode/Probe	Cloth Extendable Junction	HOLD Function	BEPS	Auto-off	Page
<b>Multiparameter</b>																					
HI98129	•	•	•			°C/°F	•	•	•	2	1		2	•	•	•	•	•	•	•	1.8
HI98130	•	•	•			°C/°F	•	•	•	2	1		2	•	•	•	•	•	•	•	1.8
HI98131	•	•	•			°C/°F	•	•	•	2	1	•	2	•	•	•	•	•	•	•	1.10
HI981304	•	•	•			°C/°F	•	•	•	2	1		2	•	•	•	•	•	•	•	1.12
<b>pH/ORP</b>																					
HI98127	•					°C/°F		•		2			2	•	•	•	•	•	•	•	1.14
HI98128	•					°C/°F	•	•		3			2	•	•	•	•	•	•	•	1.14
HI981274	•					°C/°F		•		2			2	•	•	•	•	•	•	•	1.16
HI98107	•					°C/°F		•		2					•		•				1.17
HI98108	•					°C/°F	•	•		3				•	•		•				1.17
HI981074	•					°C/°F		•		2					•		•				1.18
HI98118	•					°C/°F	•	•		2		•		•	•		•				1.19
HI98100	•						•	•		2						•					1.20
HI98103	•							•		2						•					1.20
HI981004	•						•	•		2						•					1.22
HI981014	•							•		2						•					1.22
HI98115	•						•	•		2						•					1.23
HI981030	•						•	•		2						•					1.24
HI981034	•						•	•		2						•					1.25
HI981032	•						•	•		2						•					1.26
HI981035	•						•	•		2						•					1.27
HI981036 / HI981045	•						•	•		2						•					1.28
HI981038	•						•	•		2						•					1.29
HI981039	•						•	•		2						•					1.30
HI981033	•						•	•		2						•					1.31
HI981031	•						•	•		2						•					1.32
HI981037	•						•	•		2						•	•				1.33
HI981214	•			•		°C/°F	•			2			2	•	•	•	•	•	•	•	1.36
HI981204				•		°C/°F									•	•		•	•	•	1.36
HI98120				•		°C/°F									•	•		•	•	•	1.34
HI98121	•			•		°C/°F	•			2			2	•	•	•	•	•	•	•	1.34
<b>EC/TDS</b>																					
HI98319					•	°C/°F		•						•	•						1.37
HI98325					•	°C/°F		•						•	•						1.38
HI98326					•	°C/°F		•						•	•						1.39
HI98301			•			°C/°F		•			1			•	•						1.44
HI98302			•			°C/°F		•			1			•	•						1.44
HI98303		•				°C/°F		•			1			•	•						1.44
HI98304		•				°C/°F		•			1			•	•						1.44
HI983024			•			°C/°F		•			1			•	•						1.46
HI983044		•				°C/°F		•			1			•	•						1.46
HI983124		•	•			°C/°F		•			1			•	•	•		•	•	•	1.42
HI98311		•	•			°C/°F		•			1			•	•	•		•	•	•	1.40
HI98312		•	•			°C/°F		•			1			•	•	•		•	•	•	1.40
HI98318		•	•			°C/°F		•			1	•		•	•						1.43
HI98331		•				°C/°F		•			1			•	•	•					1.45
HI98308		•									1					•					1.47
HI98309		•																			1.47

Code	pH Range	EC Range	TDS Range	ORP Range	Marine Salinity Range	Temperature Range(s)	pH Calibration Points	pH Buffer Sets	Automatic Calibration	pH Temperature Compensation	EC Temperature Compensation	TDS Temperature Compensation	CAL Check™	Waterproof	EN 13485 certified	HOLD Function	Backlit LCD	12 VDC Power Supply	Battery Power	Visual Alarm	Auto-off	Page
------	----------	----------	-----------	-----------	-----------------------	----------------------	-----------------------	----------------	-----------------------	-----------------------------	-----------------------------	------------------------------	------------	------------	--------------------	---------------	-------------	---------------------	---------------	--------------	----------	------

## Temperature

HI98501						°C/°F							•								•	1.50	
HI151						°C/°F							•	•								•	1.49
HI151-000						°C/°F							•	•	•							•	1.49
HI151-1						°C/°F							•	•								•	1.49
HI151-100						°C/°F							•	•	•							•	1.49
HI151-2						°C/°F							•	•								•	1.49
HI151-200						°C/°F							•	•	•							•	1.49
HI151-3						°C/°F							•	•								•	1.49
HI151-300						°C/°F							•	•	•							•	1.49
HI151-4						°C/°F							•	•								•	1.49
HI151-400						°C/°F							•	•	•							•	1.49
HI151-5						°C/°F							•	•								•	1.49
HI151-500						°C/°F							•	•	•							•	1.49
HI98509						°C/°F							•		•							•	1.51
HI98539						°C/°F							•									•	1.52
HI985394						°C/°F							•									•	1.52
HI145-00						°C							•									•	1.53
HI145-01						°F							•									•	1.53
HI145-20						°C							•									•	1.53
HI145-30						°F							•									•	1.53

## Monitors

HI981421	•	•	•			°C/°F	2		•	•	•	•		•		•	•	•		•		1.54	
HI981420	•	•	•			°C/°F	2		•	•	•	•		•		•	•	•		•		1.58	
HI981520	•				•	°C/°F	2		•	•				•		•	•			•		1.62	
HI146-00						°C															•		1.66
HI147-00						°C															•		1.67
HI147-01						°F															•		1.67

HI98129 (Combo) · HI98130 (Combo)

## pH/EC/TDS Testers

- **Waterproof**
  - Designed to float if accidentally dropped in a tank
- **Automatic Temperature Compensation**
  - All readings are compensated for variations in temperature
  - Temperature displayed in °C or °F along with pH reading
- **Stability indicator**
  - Meter displays a tag that will disappear when the reading has achieved stability
- **HOLD button**
  - Freezes reading on the display to allow recording of measurement
- **BEPS (Battery Error Prevention System)**
  - Meter will automatically shut off if there is not enough power to get an accurate measurement
- **Battery % level at startup**
- **Low Battery Indicator**
- **Auto-off**
  - Automatically shuts off after 8 minutes of non-use to maximize battery life

The HI98129 and HI98130 are waterproof testers that offer high accuracy pH, EC/TDS, and temperature measurements in a single tester; no more switching between meters for your routine measurements. These floating, waterproof combination testers have an easy-to-read LCD and an automatic shut-off. pH and EC/TDS readings are automatically temperature-compensated.



These testers feature a replaceable pH electrode cartridge as well as an EC/TDS graphite electrode. The replaceable pH cartridge means this tester does not need to be discarded when the pH sensor is exhausted.

The EC/TDS conversion factor is user-selectable, as well as the temperature compensation coefficient ( $\beta$ ).



## LCD Display Features



### On-screen battery life

LCD indicates the percentage of battery power remaining upon startup.



### HOLD function

The HOLD function “freezes” the LCD display temporarily.



### Instability & ATC indicators

Ensures reliable EC and TDS measurements. ATC symbol is shown when active.



### Standard or N.I.S.T buffer calibration

Automatic calibration is performed with two sets of memorized buffers for greater accuracy.



### Adjustable temperature coefficient factor

Users can choose between different factors ( $\beta$ ) for precise temperature compensated measurements.



### Adjustable TDS conversion factor

For measurement accuracy, users can choose between a range of conductivity to TDS conversion factors.

Specifications	HI98129	HI98130	
pH	Range	0.00 to 14.00 pH	0.00 to 14.00 pH
	Resolution	0.01 pH	0.01 pH
	Accuracy	$\pm 0.05$ pH	$\pm 0.05$ pH
Conductivity	Range	0 to 3999 $\mu\text{S}/\text{cm}$	0.00 to 20.00 $\text{mS}/\text{cm}$
	Resolution	1 $\mu\text{S}/\text{cm}$	0.01 $\text{mS}/\text{cm}$
	Accuracy	$\pm 2\%$ F.S.	$\pm 2\%$ F.S.
TDS	Range	0 to 2000 $\text{mg}/\text{L}$ (ppm)	0.00 to 10.00 $\text{g}/\text{L}$ (ppt)
	Resolution	1 ppm (mg/L)	0.01 ppt (g/L)
	Accuracy	$\pm 2\%$ F.S.	$\pm 2\%$ F.S.
Temperature	Range	0.0 to 60.0°C / 32.0 to 140.0°F	0.0 to 60.0°C / 32.0 to 140.0°F
	Resolution	0.1°C / 0.1°F	0.1°C / 0.1°F
	Accuracy	$\pm 0.5^\circ\text{C} / \pm 1^\circ\text{F}$	$\pm 0.5^\circ\text{C} / \pm 1^\circ\text{F}$
Additional Specifications	EC/TDS Calibration	automatic, one point at 1413 $\mu\text{S}/\text{cm}$ or 1382 ppm (mg/L)	automatic, one point at 12.88 $\text{mS}/\text{cm}$ or 6.44 ppt (g/L)
	pH Calibration	automatic, one or two-point with two sets of standard buffers (pH 4.01 / 7.01 / 10.01 or 4.01 / 6.86 / 9.18)	
	Temperature Compensation	pH: automatic; EC/TDS: automatic with $\beta$ adjustable from 0.0 to 2.4% / °C	
	TDS Conversion Factor	0.45 to 1.00	
	pH Electrode	HI73127 (replaceable; included)	
	Environment	0 to 50°C (32 to 122°F); RH max 100%	
	Battery Type / Life	1.5V (4) / approx. 100 hours of continuous use; auto-off after 8 minutes of non-use	
	Dimensions / Weight	163 x 40 x 26 mm (6.4 x 1.6 x 1.0") / 100 g (3.5 oz.)	
Ordering Information	<b>HI98129</b> (Combo) is supplied with HI73127 pH electrode, HI73128 electrode removal tool, pH 4.01 buffer solution sachet, pH 7.01 buffer solution sachet, 1413 $\mu\text{S}/\text{cm}$ conductivity standard sachet, 1382 ppm TDS standard sachet, pH electrode cleaning solution sachet, storage solution sachet, batteries, and instructions.		
	<b>HI98130</b> (Combo) is supplied with HI73127 pH electrode, HI73128 electrode removal tool, pH 4.01 buffer solution sachet, pH 7.01 buffer solution sachet, 12880 $\mu\text{S}/\text{cm}$ conductivity standard sachet, 6.44 ppt TDS standard sachet, pH electrode cleaning solution sachet, storage solution sachet, batteries, and instructions.		



### High accuracy EC/TDS graphite probe

The graphite conductivity probe provides greater accuracy because it cannot be contaminated by salt deposits. The exposed temperature sensor provides fast response times and guarantees highly accurate temperature compensated readings.



### Replaceable pH electrode cartridge

The Combo features an easy-to-replace pH electrode. The sturdy, snap-in connector means there are no pins which could bend or break.

# GroLine®

HI98131

## GroLine® pH/EC/TDS Combo Tester

- **Waterproof**
  - Designed to withstand the humidity of a growing environment
- **Automatic one-point calibration** using our Quick Cal solution
- **Automatic Temperature Compensation**
  - All readings are compensated for variations in temperature
  - Temperature displayed in °C or °F along with pH reading
- **Measurement instability indicator**
  - Meter displays a tag that will disappear when the reading has achieved stability
- **HOLD button**
  - Freezes reading on the display to allow recording of measurement
- **BEPS (Battery Error Prevention System)**
  - Meter will automatically shut off if there is not enough power to get an accurate measurement
- **Battery % level at startup**
- **Low Battery Indicator**
- **Auto-off**
  - Automatically shuts off after 8 or 60 minutes of non-use to maximize battery life

The HI98131 GroLine Combo offers high accuracy pH, EC (conductivity), TDS (total dissolved solids), and temperature measurements in a rugged, waterproof casing that floats.



The GroLine Combo features a replaceable pH electrode as well as an EC/TDS graphite electrode. The replaceable pH cartridge means this tester does not need to be discarded when the pH sensor is exhausted.

The EC/TDS conversion factor is user-selectable, as well as the temperature compensation coefficient ( $\beta$ ).





### High accuracy EC/TDS graphite probe

The graphite conductivity probe provides greater accuracy because it cannot be contaminated by salt deposits. The exposed temperature sensor provides fast response times and guarantees highly accurate temperature compensated readings.



### Replaceable pH electrode cartridge

The Combo features an easy-to-replace pH electrode. The sturdy, snap-in connector means there are no pins which could bend or break.



### Protective cap

The protective cap features an internal cup that can be filled with storage solution to keep the pH sensor moist.

## Specifications

### HI98131

pH	Range	0.00 to 14.00 pH
	Resolution	0.01 pH
	Accuracy	±0.1 pH
	Calibration	automatic, one or two-point calibration (using pH 4.01, 7.01, 10.01 buffers); one-point calibration using HI5036 or HI50036 Quick Cal calibration solution
	Temperature Compensation	automatic
EC	Range	0.00 to 6.00 mS/cm
	Resolution	0.01 mS/cm
	Accuracy	±2% F.S.
	Calibration	automatic, one-point at 1.41 mS/cm or 5.00 mS/cm; one-point calibration using Quick Cal calibration solution
	Temperature Compensation	automatic, with $\beta = 1.9\%/^{\circ}\text{C}$
TDS	Range	0 to 3000 ppm (500 CF); 0 to 3999 ppm (700 CF)
	Resolution	10 ppm (mg/L)
	Accuracy	±2% F.S.
	Conversion Factor**	0.5 (500 ppm) or 0.7 (700 ppm)
Temperature	Range*	0.0 to 60.0°C / 32.0 to 140.0°F
	Resolution	0.1°C / 0.1°F
	Accuracy	±0.5°C / ±1°F
Additional Specifications	pH Electrode	HI73127 (replaceable; included)
	Environment	0 to 50°C (32 to 122°F); RH max 100%
	Battery Type / Life	1.5V (4) / approx. 100 hours of continuous use; auto-off after 8 min or 60 min of non-use; can be disabled
	Dimensions / Weight	163 x 40 x 26 mm (6.4 x 1.6 x 1.0") / 100 g (3.5 oz.)
Ordering Information	<b>HI98131</b> (GroLine Combo) is supplied with HI73127 pH electrode, electrode removal tool, Quick Cal calibration solution sachets (4), electrode cleaning solution sachet, batteries, storage cap, quality certificate, and instruction manual.	



### Calibrate pH and EC with one solution

Calibration of both pH and EC can be performed using our Quick Cal calibration solution



### Supplied complete

Supplied with all the tools necessary to start performing tests

HI981304

## pH/EC/TDS Combo Tester

- **Waterproof**
  - Designed to float if accidentally dropped in a tank
- **Automatic Temperature Compensation**
  - All readings are compensated for variations in temperature
  - Temperature displayed in °C or °F along with pH reading
- **Stability indicator**
  - Meter displays a tag that will disappear when the reading has achieved stability
- **HOLD button**
  - Freezes reading on the display to allow recording of measurement
- **BEPS (Battery Error Prevention System)**
  - Meter will automatically shut off if there is not enough power to get an accurate measurement
- **Battery % level at startup**
- **Low Battery Indicator**
- **Auto-off**
  - Automatically shuts off after 8 minutes of non-use to maximize battery life

HI981304 is a waterproof tester that offers high accuracy pH, EC/TDS, and temperature measurements in a single tester; no more switching between meters for your routine measurements. This floating, waterproof combination tester has an easy-to-read LCD and automatic shut-off. pH and EC/TDS readings are automatically temperature-compensated.

The EC/TDS conversion factor is user-selectable, as well as the temperature compensation coefficient ( $\beta$ ).







### High accuracy EC/TDS graphite probe

The graphite conductivity probe provides greater accuracy because it cannot be contaminated by salt deposits. The exposed temperature sensor provides fast response times and guarantees highly accurate temperature compensated readings.



### Replaceable pH electrode cartridge

The Combo features an easy-to-replace pH electrode. The sturdy, snap-in connector means there are no pins which could bend or break.



### Protective cap

The protective cap features an internal cup that can be filled with storage solution to keep the pH sensor moist.

Specifications	HI981304	
pH	Range	0.00 to 14.00 pH
	Resolution	0.01 pH
	Accuracy	±0.05 pH
Conductivity	Range	0.00 to 20.00 mS/cm
	Resolution	0.01 mS/cm
	Accuracy	±2% F.S.
TDS	Range	0.00 to 10.00 g/L (ppt)
	Resolution	0.01 ppt (g/L)
	Accuracy	±2% F.S.
Temperature	Range	0.0 to 60.0°C / 32.0 to 140.0°F
	Resolution	0.1°C / 0.1°F
	Accuracy	±0.5°C / ±1°F
Additional Specifications	EC/TDS Calibration	automatic, one point at 12.88 mS/cm or 6.44 ppt (g/L)
	pH Calibration	automatic, one or two-point with two sets of standard buffers (pH 4.01 / 7.01 / 10.01 or 4.01 / 6.86 / 9.18)
	Temperature Compensation	pH: automatic; EC/TDS: automatic with $\beta$ adjustable from 0.0 to 2.4% / °C
	TDS Conversion Factor	0.45 to 1.00
	pH Electrode	HI73127 (replaceable; included)
	Environment	0 to 50°C (32 to 122°F); RH max 100%
	Battery Type / Life	1.5V (4) / approx. 100 hours of continuous use; auto-off after 8 minutes of non-use
	Dimensions / Weight	163 x 40 x 26 mm (6.4 x 1.6 x 1.0") / 100 g (3.5 oz.)
Ordering Information	<b>HI981304</b> is supplied with HI73127 pH electrode, HI73128 electrode removal tool, pH 4.01 buffer solution sachet, pH 7.01 buffer solution sachet, 12880 $\mu$ S/cm conductivity standard sachet, 6.44 ppt TDS standard sachet, pH electrode cleaning solution sachet, storage solution sachet, batteries, and instructions.	



### Calibrate right in our sachets

Calibration can be performed directly in our solution sachets

### Supplied complete

Supplied with all the tools necessary to start performing tests

HI98127 (pHep®4) · HI98128 (pHep®5)

## pH and Temperature Testers

- **Waterproof**
  - Designed to float if accidentally dropped in water
- **Up to three-point calibration (HI98128)**
- **Automatic Temperature Compensation**
  - All readings are compensated for variations in temperature
  - Temperature displayed in °C or °F along with pH reading
- **Stability indicator**
  - Meter displays a tag that will disappear when the reading has achieved stability
- **HOLD button**
  - Freezes reading on the display to allow recording of measurement
- **BEPS (Battery Error Prevention System)**
  - Meter will automatically shut off if there is not enough power to get an accurate measurement
- **Battery % level at startup**
- **Low Battery Indicator**
- **Automatic Shut-Off**
  - The meter can be set to automatically turn off after 8 minutes or 60 minutes to conserve battery life in the event that the meter is left on. The auto off feature can be disabled.

The pHep®4 and pHep®5 are waterproof pH testers that have many advanced features found in more expensive portable instrumentation. These ergonomic meters feature automatic one, two or (HI98128) three-point calibration to a known buffer, automatic temperature compensation, battery percent level indicator at start up, and a stability indicator to alert the user when a stable reading has been obtained. The large multi level LCD display shows both pH and temperature simultaneously.



These meters also feature the HI73127 replaceable electrode with a stainless steel round connector. This cartridge design has no pins which could bend or break.



## LCD Display Features



### On-screen battery life

LCD indicates the percentage of battery power remaining upon startup.



### HOLD function

The HOLD function “freezes” the LCD display temporarily.



### Standard or N.I.S.T buffer calibration

Automatic calibration is performed with two sets of memorized buffers for greater accuracy.



### Replaceable pH electrode cartridge

The Combo features an easy-to-replace pH electrode. The sturdy, snap-in connector means there are no pins which could bend or break.



### Exposed temperature sensor

An exposed temperature sensor allows for rapid automatic temperature compensated pH measurements.



### Pocket clip

A pocket clip is featured on the back of the pHep 4 and pHep 5

Specifications		HI98127 (pHep®4)	HI98128 (pHep®5)
pH	Range	-2.0 to 16.0 pH	-2.00 to 16.00 pH
	Resolution	0.1 pH	0.01 pH
	Accuracy	±0.1 pH	±0.05 pH
Temperature	Range	-5.0 to 60.0°C / 23.0 to 140.0°F	-5.0 to 60.0°C / 23.0 to 140.0°F
	Resolution	0.1°C / 0.1°F	0.1°C / 0.1°F
	Accuracy	±0.5°C / ±1°F	±0.5°C / ±1°F
Additional Specifications	pH Calibration	automatic, one, two, or (HI98128) three-point with two sets of standard buffers (pH 4.01 / 7.01 / 10.01 or 4.01 / 6.86 / 9.18)	
	Temperature Compensation	automatic	
	Battery Type / Life	1.5V (4) / approx. 300 hours of continuous use; auto-off after 8 minutes of non-use	
	Environment	-5 to 50°C (23 to 122°F); RH max 100%	
	Dimensions	163 x 40 x 26 mm (6.4 x 1.6 x 1.0")	
	Weight	100 g (3.5 oz.)	
Ordering Information	<b>HI98127</b> (pHep®4) and <b>HI98128</b> (pHep®5) are supplied with HI73127 pH electrode, HI73128 electrode removal tool, pH 4.01 buffer solution sachets (2), pH 7.01 buffer solution sachets (2), electrode cleaning solution sachet, electrode storage solution sachet, batteries, and instructions.		



### Protective cap

The protective cap features an internal cup that can be filled with storage solution to keep the pH sensor moist.

HI981274

## pH and Temperature Tester

- **Waterproof**
  - Designed to float if accidentally dropped in water
- **Automatic Temperature Compensation**
  - All readings are compensated for variations in temperature
  - Temperature displayed in °C or °F along with pH reading
- **Stability indicator**
  - Meter displays a tag that will disappear when the reading has achieved stability
- **HOLD button**
  - Freezes reading on the display to allow recording of measurement
- **BEPS (Battery Error Prevention System)**
  - Meter will automatically shut off if there is not enough power to get an accurate measurement
- **Battery % level at startup**
- **Low Battery Indicator**
- **Automatic Shut-Off**
  - The meter can be set to automatically turn off after 8 minutes or 60 minutes to conserve battery life in the event that the meter is left on. The auto off feature can be disabled.

This tester provides high accuracy pH and temperature measurement in a rugged, waterproof casing that floats.

This meter also features the HI73127 replaceable electrode with a stainless steel round connector. This cartridge design has no pins which could bend or break.

The protective cap features an internal cup that can be filled with storage solution to keep the pH sensor moist.



### Specifications

### HI981274

pH	Range	-2.0 to 16.0 pH
	Resolution	0.1 pH
	Accuracy	±0.1 pH
Temperature	Range	-5.0 to 60.0°C / 23.0 to 140.0°F
	Resolution	0.1°C / 0.1°F
	Accuracy	±0.5°C / ±1°F
Additional Specifications	pH Calibration	automatic, one or two-point with two sets of standard buffers (pH 4.01 / 7.01 / 10.01 or 4.01 / 6.86 / 9.18)
	Temperature Compensation	automatic
	Battery Type / Life	1.5V (4) / approx. 300 hours of continuous use; auto-off after 8 minutes of non-use
	Environment	-5 to 50°C (23 to 122°F); RH max 100%
	Dimensions	163 x 40 x 26 mm (6.4 x 1.6 x 1.0")
	Weight	100 g (3.5 oz.)
<b>Ordering Information</b>	<b>HI981274</b> is supplied with HI73127 pH electrode, electrode removal tool, protective cap, pH 4.01 buffer solution sachets (2), pH 7.01 buffer solution sachets (2), electrode cleaning solution sachet, electrode storage solution sachet, batteries, and instructions.	



## HI98107 pHep® · HI98108 pHep+ pHep pH Testers

- Waterproof
- Up to three-point calibration (HI98108)
- Built in temperature sensor for Automatic Temperature Compensated measurements
- Automatic one or two-point calibration
- Stability indicator
- Low battery indicator
- Two-button operation

The pHep is used by millions of people around the world to monitor pH in laboratories and industrial applications as well as in agriculture, fish farming, food manufacturing and quality control, swimming pools, and the printing industry.



Exposed temperature sensor for faster response times



### Watertight seal

An easily removable cover provides access to the battery compartment.



Supplied in a carrying case with buffer and cleaning solutions.

Specifications		HI98107 (pHep®)	HI98108 (pHep®+)
pH	Range	0.0 to 14.0 pH	0.00 to 14.00 pH
	Resolution	0.1 pH	0.01 pH
	Accuracy (@25°C/77°F)	±0.1 pH	±0.10 pH
	Calibration	automatic, one, two, or (HI98108) three-point (pH 4.01, 7.01, 10.01)	
Temperature	Range	0.0 to 50.0 °C (32.0 to 122.0 °F)	0.0 to 50.0 °C (32.0 to 122.0 °F)
	Resolution	0.1°C / 0.1°F	0.1°C / 0.1°F
	Accuracy (@25°C/77°F)	±0.5°C / ±1.0°F	±0.5°C / ±1.0°F
Additional Specifications	Temperature Compensation	automatic, 0 to 50°C (32 to 122°F)	
	Glass Type	GP (general purpose)	
	Battery Type / Life	CR2032 3V Li-ion / approximately 800 hours of continuous use	
	Auto-off	8 minutes, 60 minutes, or can be disabled	
	Environment	0 to 50°C (32 to 122°F); RH 100% max	
	Dimensions	160 x 40 x 17 mm (6.3 x 1.6 x 0.7")	
	Weight	75 g (2.6 oz.)	
Ordering Information	<b>HI98107</b> (pHep) is supplied with CR2032 battery, electrode cleaning solution sachet, pH 4.01 buffer solution sachet, pH 7.01 buffer solution sachet (2), storage/protection sleeve, instruction manual, and quality certificate.		
	<b>HI98108</b> (pHep+) is supplied with CR2032 battery, electrode cleaning solution sachet, pH 4.01 buffer solution sachet, pH 7.01 buffer solution sachet (2), storage/protection sleeve, instruction manual, and quality certificate.		

HI981074

## pH Tester

- Waterproof
- Built in temperature sensor for Automatic Temperature Compensated measurements
- Automatic one or two-point calibration
- Stability indicator
- Low battery indicator
- Two-button operation

HI981074 is a pocket-sized pH meter, part of Hanna Instruments® Pool Line family. It has a compact and waterproof casing, and automatic pH calibration at one or two points. All readings are automatically compensated for temperature variations with a built-in temperature sensor.



Exposed temperature sensor for faster response times



### Watertight seal

An easily removable cover provides access to the battery compartment.

### Carrying case included

Supplied in a carrying case with buffer and cleaning solutions.



Specifications	HI981074	
pH	Range	0.0 to 14.0 pH
	Resolution	0.1 pH
	Accuracy (@25°C/77°F)	±0.1 pH
	Calibration	automatic, one or two-points (pH 4.01, 7.01, 10.01)
Temperature	Range	0.0 to 50.0 °C (32.0 to 122.0 °F)
	Resolution	0.1°C / 0.1°F
	Accuracy (@25°C/77°F)	±0.5°C / ±1.0°F
Additional Specifications	Temperature Compensation	automatic, 0 to 50°C (32 to 122°F)
	Glass Type	GP (general purpose)
	Battery Type / Life	CR2032 3V Li-ion / approximately 800 hours of continuous use
	Auto-off	8 minutes, 60 minutes, or can be disabled
	Environment	0 to 50°C (32 to 122°F); RH 100% max
	Dimensions	160 x 40 x 17 mm (6.3 x 1.6 x 0.7")
	Weight	75 g (2.6 oz.)
Ordering Information	HI981074 is supplied with electrode cleaning solution sachet, pH 4.01 buffer solution sachet, pH 7.01 buffer solution sachet (2), storage/protection sleeve, CR2032 battery, instruction manual, and quality certificate.	

## GroLine® pH Tester

- Waterproof
- Quick calibration mode using Hanna Quick Cal pH/EC calibration solution
- Two-button operation

The GroLine HI98118 pH/temperature tester is our latest pocket meter for measuring the pH of a hydroponic nutrient solution. The HI98118 has a very large easy to read LCD display that shows both pH and temperature along with calibration, stability, and low battery indicators. All operations are simplified to two buttons.



Exposed temperature sensor for faster response times



### Watertight seal

An easily removable cover provides access to the battery compartment.



Supplied in a carrying case with buffer and cleaning solutions.



### Specifications

### HI98118

pH	Range	0.00 to 14.00 pH
	Resolution	0.01 pH
	Accuracy (@25°C/77°F)	±0.10 pH
	Calibration	automatic, one or two-points (pH 4.01, 7.01, 10.01)
	Quick Calibration	one-point calibration using HI5036 or HI50036P Quick Cal calibration solution
Temperature	Range	0.0 to 50.0 °C (32.0 to 122.0 °F)
	Resolution	0.1°C/0.1°F
	Accuracy (@25°C/77°F)	±0.5°C/±1.0°F
Additional Specifications	Temperature Compensation	automatic, 0 to 50°C (32 to 122°F)
	Glass Type	GP (general purpose)
	Battery Type / Life	CR2032 3V Li-ion / approximately 1000 hours of continuous use
	Auto-off	8 minutes, 60 minutes, or can be disabled
	Environment	0 to 50°C (32 to 122°F); RH 100% max
	Dimensions	160 x 40 x 17 mm (6.3 x 1.6 x 0.7")
	Weight	75 g (2.6 oz.)
	Ordering Information	<b>HI98118</b> GroLine pH tester, Quick Cal calibration sachets (3), electrode cleaning solution sachet, battery, instruction manual, and quality certificate.

HI98100 · HI98103

## Checker® pH Testers

The latest HI98103 Checker and HI98100 Checker Plus are the next generation of the original Hanna Checker pH tester. The Checker is by far one of the most popular pH meters in the world with over 1 million meters used since its introduction in 1991. From students to researchers, the Checker has been helping people with their pH measurements.

These Checker pH testers have been designed with many advanced features while maintaining the look and feel of the original Checker. The HI98100 Checker Plus and HI98103 Checker now offer automatic calibration to one or two points, automatic buffer recognition, calibrated buffer tags, stability indicator, low battery indicator, and selectable automatic shut off. Both the Checker and Checker Plus maintain the iconic pentagon design with a probe measuring 103 mm in length that is tapered to an 8 mm diameter, making it ideal for measurements in test tubes and vials.

Over 1 million  
users since its  
introduction



### Replaceable pH Electrode

The supplied HI1271 pH electrode is 103 mm long and tapers to an 8 mm diameter at the sensing end to easily fit into test tubes, vials, and other containers with small openings.

### Economical

The Checker and Checker Plus are full-featured pH testers at an affordable price.

### High accuracy

The HI98100 Checker Plus features  $\pm 0.2$  pH accuracy with 0.01 resolution while the HI98103 features 0.1 resolution.

### Large LCD

Enhanced LCD that displays reading, stability indicator, low battery indicator, and calibration tags.

### Automatic Calibration

These meters are calibrated automatically to one or two points. The calibration buffers are automatically recognized and after calibration the buffer values used are shown on the display as a tag.

### Stability Indicator

An hourglass indicator is displayed on the LCD until a stable reading is obtained. Once a reading stabilizes, the indicator disappears and a reading can be recorded.

### Automatic Shut-off

These meters can be set to automatically turn off after 8 minutes or 60 minutes to conserve battery life in the event that the meter is left on. The auto-off feature can also be disabled.

### Long Battery Life

These Checkers have a long battery life of approximately 1000 hours. When the battery power is running low a battery indicator is displayed.

### Plastic Carrying Case

The HI98100 and HI98103 are supplied complete with meter, probe, calibration solutions, and cleaning solutions packaged in a durable plastic carrying case.







The HI1271 pH electrode can be easily replaced. Just unscrew the electrode from the meter body and screw on a new one.



Calibration can be performed directly in our solution sachets.

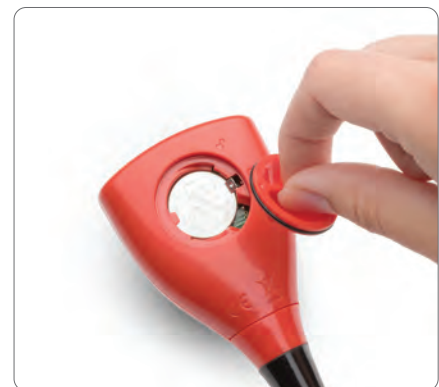

An easily removable cover provides access to the replaceable battery.



Supplied in a carrying case with buffer and cleaning solutions.

Specifications	HI98100 Checker®Plus	HI98103 Checker	
pH	Range	0.00 to 14.00 pH	0.0 to 14.0 pH
	Resolution	0.01 pH	0.1 pH
	Accuracy (@25°C/77°F)	±0.2 pH	
	Calibration	automatic, one or two-point	
Additional Specifications	Electrode	HI1271 (included)	
	Battery Type / Life	CR2032 Li-ion / approximately 1000 hours of continuous use	
	Auto-off	8 minutes, 60 minutes, or can be disabled	
	Environment	0 to 50°C (32 to 122°F); RH 95% max	
	Dimensions	50 x 174 x 21 mm (2 x 6.8 x 0.9")	
	Weight	50 g (1.8 oz)	
Ordering Information	<b>HI98100 (Checker)</b> and <b>HI98103 (Checker Plus)</b> are supplied with HI1271 pH electrode, pH 4.01 buffer solution sachet (2), pH 7.01 buffer solution sachet (2), electrode cleaning solution sachet (2), battery, quality certificate, and instruction manual in a carrying case.		

## pH Testers

### Replaceable pH Electrode

The supplied HI1271 pH electrode is 103 mm long and tapers to an 8 mm diameter at the sensing end to easily fit into test tubes, vials, and other containers with small openings.

### High accuracy

The HI981004 features  $\pm 0.2$  pH accuracy with 0.01 resolution while the HI981014 features 0.1 resolution.

### Large LCD

Enhanced LCD that displays reading, stability indicator, low battery indicator, and calibration tags.

### Automatic Calibration

This meter is calibrated automatically to one or two points. The calibration buffers are automatically recognized and after calibration the buffer values used are shown on the display as a tag.

### Stability Indicator

An hourglass indicator is displayed on the LCD until a stable reading is obtained. Once a reading stabilizes, the indicator disappears and a reading can be recorded.

### Automatic Shut-off

These testers can be set to automatically turn off after 8 minutes or 60 minutes to conserve battery life in the event that the meter is left on. The auto-off feature can also be disabled.

### Long Battery Life

This meter has a long battery life of approximately 1000 hours. When the battery power is running low a battery indicator is displayed.

### Plastic Carrying Case

The HI981004 and HI981014 are supplied complete with meter, probe, calibration solutions, and cleaning solutions packaged in a durable plastic carrying case.



Specifications	HI981004	HI981014	
pH	Range	0.00 to 14.00 pH	0.0 to 14.0 pH
	Resolution	0.01 pH	0.1 pH
	Accuracy (@25°C/77°F)	$\pm 0.2$ pH	
	Calibration	automatic, one or two-point	
Additional Specifications	Electrode	HI1271 (included)	
	Battery Type / Life	CR2032 Li-ion / approximately 1000 hours of continuous use	
	Auto-off	8 minutes, 60 minutes, or can be disabled	
	Environment	0 to 50°C (32 to 122°F); RH 95% max	
	Dimensions	50 x 174 x 21 mm (2 x 6.8 x 0.9")	
	Weight	50 g (1.8 oz)	
Ordering Information	<b>HI981004</b> and <b>HI981014</b> are supplied with HI1271 pH electrode, pH 4.01 buffer solution sachet (2), pH 7.01 buffer solution sachet (2), electrode cleaning solution sachet (2), battery, quality certificate, and instruction manual in a carrying case.		

# GroLine®

HI98115

## pH Tester

The HI98115 GroLine® pH tester has been designed with many advanced features for growers of all types. This pH tester offers automatic calibration to one or two points, automatic buffer recognition, calibrated buffer tags, stability indicator, low battery indicator, and selectable automatic shut-off. With its compact size, one-button operation, and ease of calibration, the HI98115 is the optimal tool for pH measurement in nutrient solutions and soil slurries.

### Replaceable pH Electrode

The HI1271 supplied gel filled pH electrode is 103 mm long and tapers to an 8 mm diameter at the sensing end. This narrow electrode easily fits into test tubes, vials, and other containers with small openings.

### Economical

The HI98115 is a full-featured pH tester at a price that anyone that needs to measure pH can afford.

### High accuracy

The HI98115 GroLine pH tester features  $\pm 0.2$  pH accuracy with 0.01 resolution.

### Large LCD

Enhanced LCD that displays reading, stability indicator, low battery indicator, and calibration tags.

### Automatic Calibration

HI98115 is calibrated automatically to one or two points. The calibration buffers are automatically recognized and after calibration the buffer values used are shown on the display as a tag.

### Stability Indicator

An hourglass indicator is displayed on the LCD until a stable reading is obtained. Once a reading stabilized the indicator disappears and a reading can be recorded.

### Automatic Shut-Off

The meter can be set to automatically turn off after 8 minutes or 60 minutes to conserve battery life in the event that the meter is left on. The auto off feature can be disabled.



The HI1271 pH electrode can be easily replaced. Just unscrew the electrode from the meter body and screw on a new one.



### Plastic Carrying Case

Supplied complete with meter, probe, calibration solutions, and cleaning solutions packaged in a durable plastic carrying case.

#### Specifications

#### HI98115

pH	Range	0.00 to 14.00 pH
	Resolution	0.01 pH
	Accuracy (@25°C/77°F)	$\pm 0.2$ pH
	Calibration	automatic, one or two-point
Additional Specifications	Electrode	HI1271 (included)
	Battery Type / Life	CR2032 Li-ion / approximately 1000 hours of continuous use
	Auto-off	8 minutes, 60 minutes, or can be disabled
	Environment	0 to 50°C (32 to 122°F); RH 95% max
	Dimensions	50 x 174 x 21 mm (2 x 6.8 x 0.9")
	Weight	50 g (1.8 oz)
Ordering Information	<b>HI98115</b> is supplied with HI1271 pH electrode, pH 4.01 buffer solution sachet (2), pH 7.01 buffer solution sachet (2), electrode cleaning solution sachet (2), battery, quality certificate, and instruction manual in a carrying case.	

# GroLine®

HI981030

## Soil pH Tester

with specialized probe

The HI981030 GroLine® soil pH tester is an application specific designed pH tester for the measurement of soil pH. This tester offers many advanced features including the ability to clear any clogging of the reference junction, which results in a longer life than standard pH testers.

- **pH electrode with replaceable bridge electrolyte**
  - The pH electrode has an outer junction sleeve that can be removed and cleaned. Once cleaned a small amount of supplied gel electrolyte is added and the junction is refreshed improving the pH measurement and extending the life of the meter.
- **Conical tip**
  - Allows for easy penetration into wetted soil. If stones are present or the soil is hardened then it is best to use an auger to make a hole for the pH electrode to be inserted into. If the soil is dry the use of purified water can be used to wet the soil.
- **PVDF body**
  - Polyvinylidene Fluoride (PVDF) is a food grade plastic that is resistant to most chemicals and solvents, including sodium hypochlorite that is used for disinfection. It has high abrasion resistance, mechanical strength, and resistance to ultraviolet light. PVDF is also resistant to fungal growth.
- **Large LCD**
  - An enhanced LCD displays the measurement reading, stability indicator, low battery indicator, and calibration tags.
- **Automatic calibration**
  - The GroLine soil pH tester is calibrated automatically to one or two points. The calibration buffers are automatically recognized and after calibration the buffer values used are shown on the display.
- **Automatic temperature compensation**
- **Stability indicator**
  - An hourglass indicator is displayed on the LCD until a stable reading is obtained. Once a reading stabilizes, the indicator disappears and a reading can be taken.
- **Automatic shut-off**
  - The meter can be set to automatically turn off after 8 minutes or 60 minutes to conserve battery life in the event that the meter is left on. The auto-off feature can also be disabled.
- **Probe diagnostic**
  - During calibration the meter will display an error (Err) message as an indicator that the probe needs to be cleaned.
- **Long battery life**
  - The GroLine soil pH tester has an exceptional battery life of approximately 800 hours. When the battery power is running low, the low battery indicator blinks.
- **Economical**
  - The GroLine soil pH tester is an advanced meter at a price that is affordable for both the home gardener and professional grower.



Removable sleeve to extend probe life



Supplied complete

Supplied complete with meter, probe, calibration solutions, and cleaning solutions.

### Specifications

### HI981030

pH	Range	0.00 to 12.00 pH
	Resolution	0.01 pH
	Accuracy (@25°C/77°F)	±0.05 pH
	Calibration	automatic, one or two-point
Additional Specifications	Temperature Compensation	automatic, 0 to 50°C (32 to 122°F)
	Glass Type	LT (low temperature)
	Battery Type / Life	CR2032 Li-ion / approx. 800 hours of continuous use
	Auto-off	8 minutes, 60 minutes, or disabled
	Environment	0 to 50°C (32 to 122°F); RH 95% max
	Dimensions	51 x 151 x 21 mm (2 x 5.9 x 0.9")
	Weight	44 g (1.6 oz.)
<b>Ordering Information</b>	<b>HI981030</b> is supplied with pH 4.01 buffer solution sachets (2), pH 7.01 buffer solution sachets (2), electrode cleaning solution sachets for deposits of soil (1) and humus (1), gelled bridge electrolyte, electrode storage solution, CR2032 3V Li-ion battery, quality certificate, and instruction manual.	

## Foodcare

HI981034

### Milk pH Tester

with specialized probe

The HI981034 Foodcare Milk pH tester is an application specific designed pH tester for the measurement of pH in the milk production process. This tester offers many advanced features including resistance to clogging of the reference junction, which results in a longer life than standard pH testers.

- **pH electrode with open junction**
  - The pH electrode of this tester uses an open outer junction design. The open junction is more resistant to clogging when the probe is inserted into solids and semisolids than pH electrodes that use ceramic or other porous materials.
- **Low temperature (LT) glass**
  - The pH glass tip uses a special low temperature (LT) glass formulation with a lower resistance of approximately 50 Megaohms compared to general purpose (GP) with a resistance of about 100 Megaohms. This is beneficial when measuring food products at lower temperatures in order to have the ideal resistance for the measuring circuit.
- **Conical tip**
  - Allows for a large surface area and easy penetration into semisolids making it ideal for milk and milk products like yogurt.
- **Glass body**
  - Glass body is non-porous and easy to clean and disinfect.
- **Large LCD**
  - An enhanced LCD displays the measurement reading, stability indicator, low battery indicator, and calibration tags.
- **Automatic calibration**
  - The Foodcare Milk pH Tester is calibrated automatically to one or two points. The calibration buffers are automatically recognized and after calibration the buffer values used are shown on the display.
- **Automatic temperature compensation**
- **Stability indicator**
  - An hourglass indicator is displayed on the LCD until a stable reading is obtained. Once a reading stabilizes, the indicator disappears and a reading can be taken.
- **Automatic shut-off**
  - The meter can be set to automatically turn off after 8 minutes or 60 minutes to conserve battery life in the event that the meter is left on. The auto-off feature can also be disabled.
- **Probe diagnostic**
  - During calibration the meter will display an error (Err) message as an indicator that the probe needs to be cleaned.
- **Long battery life**
  - The Foodcare Milk pH Tester has an exceptional battery life of approximately 800 hours. When the battery power is running low, the low battery indicator blinks.
- **Economical**
  - The Foodcare Milk pH Tester is an advanced meter at a price that is affordable for both the hobbyist and professional.

#### Conical tip electrode

Easy to clean electrode with a maintenance-free gel electrolyte



#### Supplied complete

Supplied complete with meter, probe, calibration solutions, and cleaning solutions.

Specifications	HI981034	
pH	Range	0.00 to 12.00 pH
	Resolution	0.01 pH
	Accuracy (@25°C/77°F)	±0.05 pH
	Calibration	automatic, one or two-point
Additional Specifications	Temperature Compensation	automatic, 0 to 50°C (32 to 122°F)
	Glass Type	LT (low temperature)
	Battery Type / Life	CR2032 Li-ion / approx. 800 hours of continuous use
	Auto-off	8 minutes, 60 minutes, or disabled
	Environment	0 to 50°C (32 to 122°F); RH 95% max
	Dimensions	51 x 159 x 21 mm (2 x 6.3 x 0.9")
	Weight	50 g (1.8 oz.)
Ordering Information	HI981034 is supplied with pH 4.01 buffer solution sachet (2), pH 7.01 buffer solution sachet (2), electrode cleaning solution sachet (2), electrode storage solution, CR2032 3V Li-ion battery, quality certificate, and instruction manual.	

## Foodcare

HI981032

### Cheese pH Tester

with specialized probe

The HI981032 Foodcare Cheese pH tester is an application specific designed pH tester for the measurement of pH during the cheesemaking process. This tester offers many advanced features including a pH electrode designed specifically for cheese.

- pH Electrode with open junction**
  - The pH electrode of this tester uses an open outer junction design. The open junction is more resistant to clogging when the probe is inserted into solids and semisolids than pH electrodes that use ceramic or other porous materials.
- Low temperature (LT) glass**
  - The pH glass tip uses a special low temperature (LT) glass formulation with a lower resistance of approximately 50 Megaohms compared to general purpose (GP) with a resistance of about 100 Megaohms. This is beneficial when measuring food products at lower temperatures in order to have the ideal resistance for the measuring circuit.
- Conical tip**
  - Allows for easy penetration into solids and semisolids, which is needed when wanting to take a direct measurement in cheese.
- PVDF body**
  - Polyvinylidene Fluoride (PVDF) is a food grade plastic that is resistant to most chemicals and solvents, including sodium hypochlorite. It has high abrasion resistance, mechanical strength, and resistance to ultraviolet. PVDF is also resistant to fungal growth.
- Large LCD**
  - An enhanced LCD displays the measurement reading, stability indicator, low battery indicator, and calibration tags.
- Automatic calibration**
  - The Foodcare Cheese pH Tester is calibrated automatically to one or two points. The calibration buffers are automatically recognized and after calibration the buffer values used are shown on the display.
- Automatic temperature compensation**
- Stability indicator**
  - An hourglass indicator is displayed on the LCD until a stable reading is obtained. Once a reading stabilizes, the indicator disappears and a reading can be taken.
- Automatic shut-off**
  - The meter can be set to automatically turn off after 8 minutes or 60 minutes to conserve battery life in the event that the meter is left on. The auto-off feature can also be disabled.
- Probe diagnostic**
  - During calibration the meter will display an error (Err) message as an indicator that the probe needs to be cleaned.
- Long battery life**
  - The Foodcare Cheese pH Tester has an exceptional battery life of approximately 800 hours. When the battery power is running low, the low battery indicator blinks.
- Economical**
  - The Foodcare Cheese pH Tester is an advanced meter at a price that is affordable for both the hobbyist and professional.



#### Conical tip electrode

Easy to clean electrode with a maintenance-free gel electrolyte



#### Supplied complete

Supplied complete with meter, probe, calibration solutions, and cleaning solutions.

Specifications	HI981032	
pH	Range	0.00 to 12.00 pH
	Resolution	0.01 pH
	Accuracy (@25°C/77°F)	±0.05 pH
	Calibration	automatic, one or two-point
Additional Specifications	Temperature Compensation	automatic, 0 to 50°C (32 to 122°F)
	Glass Type	LT (low temperature)
	Battery Type / Life	CR2032 Li-ion / approx. 800 hours of continuous use
	Auto-off	8 minutes, 60 minutes, or disabled
	Environment	0 to 50°C (32 to 122°F); RH 95% max
	Dimensions	50 x 129 x 21 mm (2 x 5.1 x 0.9")
	Weight	40 g (1.4 oz.)
Ordering Information	<p><b>HI981032</b> is supplied with pH 4.01 buffer solution sachets (2), pH 7.01 buffer solution sachets (2), electrode cleaning solution sachets (2), electrode storage solution, CR2032 3V Li-ion battery, quality certificate, and instruction manual.</p>	

## Foodcare

HI981035

### Sushi pH Tester

with specialized probe

The HI981035 Foodcare Sushi pH tester is an application specific designed pH tester for the measurement of pH of sushi rice as part of a Hazardous Analysis of Critical Control Points (HACCP) plan. This tester offers many advanced features including a pH electrode designed specifically for sushi.

- **Flat tip pH sensor**
  - A flat tip pH electrode allows for the direct measurement of solids by simply touching the surface of the product. No need to make slurries with purified water.
- **pH Electrode with open junction**
  - The pH electrode of this tester uses an open outer junction design. The open junction is clog resistant due to the hard gel surface known as Viscolene that is used for the reference cell. When the junction becomes coated with starch from the rice simply clean the probe to expose the viscolene reference.
- **Titanium body**
  - A titanium body offers additional protection as compared to traditional glass body pH probes.
- **Large LCD**
  - An enhanced LCD displays the measurement reading, stability indicator, low battery indicator, and calibration tags.
- **Automatic calibration**
  - The Foodcare Sushi pH Tester is calibrated automatically to one or two points. The calibration buffers are automatically recognized and after calibration the buffer values used are shown on the display.
- **Automatic temperature compensation**
- **Stability indicator**
  - An hourglass indicator is displayed on the LCD until a stable reading is obtained. Once a reading stabilizes, the indicator disappears and a reading can be taken.
- **Automatic shut-off**
  - The meter can be set to automatically turn off after 8 minutes or 60 minutes to conserve battery life in the event that the meter is left on. The auto-off feature can also be disabled.
- **Probe diagnostic**
  - During calibration the meter will display an error (Err) message as an indicator that the probe needs to be cleaned.
- **Long battery life**
  - The Foodcare Sushi pH Tester has an exceptional battery life of approximately 800 hours. When the battery power is running low, the low battery indicator blinks.
- **Economical**
  - The Foodcare Sushi pH Tester is a feature rich meter at a price that is affordable for both the hobbyist and professional.

#### Flat tip electrode

Easy to clean electrode with a maintenance-free gel electrolyte



#### Supplied complete

Supplied complete with meter, probe, calibration solutions, and cleaning solutions

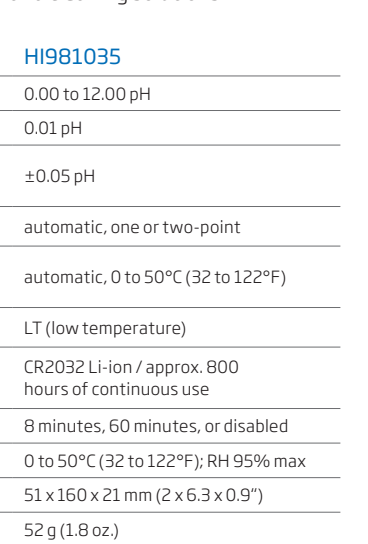

Specifications	HI981035	
pH	Range	0.00 to 12.00 pH
	Resolution	0.01 pH
	Accuracy (@25°C/77°F)	±0.05 pH
	Calibration	automatic, one or two-point
Additional Specifications	Temperature Compensation	automatic, 0 to 50°C (32 to 122°F)
	Glass Type	LT (low temperature)
	Battery Type / Life	CR2032 Li-ion / approx. 800 hours of continuous use
	Auto-off	8 minutes, 60 minutes, or disabled
	Environment	0 to 50°C (32 to 122°F); RH 95% max
	Dimensions	51 x 160 x 21 mm (2 x 6.3 x 0.9")
	Weight	52 g (1.8 oz.)
Ordering Information	HI981035 is supplied with pH 4.01 buffer solution sachets (2), pH 7.01 buffer solution sachets (2), electrode cleaning and disinfection solution sachets (2), electrode storage solution, CR2032 3V Li-ion battery, quality certificate, and instruction manual.	

# Foodcare

HI981036 • HI981045

## Meat pH Testers

with specialized probe

HI981036 and HI981045 Foodcare Meat pH testers are application specific designed pH testers for the measurement of pH during the meat processing process. These testers offer many advanced features including a pH electrode designed specifically for meat.

- Meets Hazard Analysis Critical Control (HACCP) process standards
- pH electrode with replaceable bridge electrolyte
  - The pH electrode has an outer junction sleeve that can be removed and cleaned. Once cleaned a small amount of supplied gel electrolyte is added and the junction is refreshed improving the pH measurement and extending the life of the meter.
- Low temperature (LT) glass
  - The pH glass tip uses a special low temperature (LT) glass formulation suited for fast stabilization and accurate results at lower temperatures in order to have the ideal resistance for the measuring circuit.
- Conical tip
  - Allows for easy penetration into solids and semisolids, which is needed when wanting to take a direct measurement in meat.
- Removable stainless steel meat blade available (HI981045 only)
  - The HI981045 features threads at the base of the probe for compatibility with the FC097 stainless steel meat blade (optional accessory).
- PVDF body
  - Polyvinylidene Fluoride (PVDF) is a food grade plastic that is resistant to most chemicals and solvents, including sodium hypochlorite. It has high abrasion resistance, mechanical strength, and resistance to ultraviolet light. PVDF is also resistant to fungal growth.
- Large LCD
  - An enhanced LCD displays the measurement reading, stability indicator, low battery indicator, and calibration tags.
- Automatic calibration
  - These testers are calibrated automatically to one or two points. The calibration buffers are automatically recognized and after calibration the buffer values used are shown on the display.
- Automatic temperature compensation
- Stability indicator
  - An hourglass indicator is displayed on the LCD until a stable reading is obtained. Once a reading stabilizes, the indicator disappears and a reading can be taken.
- Automatic shut-off
  - These testers can be set to automatically turn off after 8 minutes or 60 minutes to conserve battery life in the event that the tester is left on. The auto-off feature can also be disabled.
- Probe diagnostic
  - During calibration the meter will display an error (Err) message as an indicator that the probe needs to be cleaned.
- Long battery life
  - These testers have an exceptional battery life of approximately 800 hours. When the battery power is running low, the low battery indicator blinks.

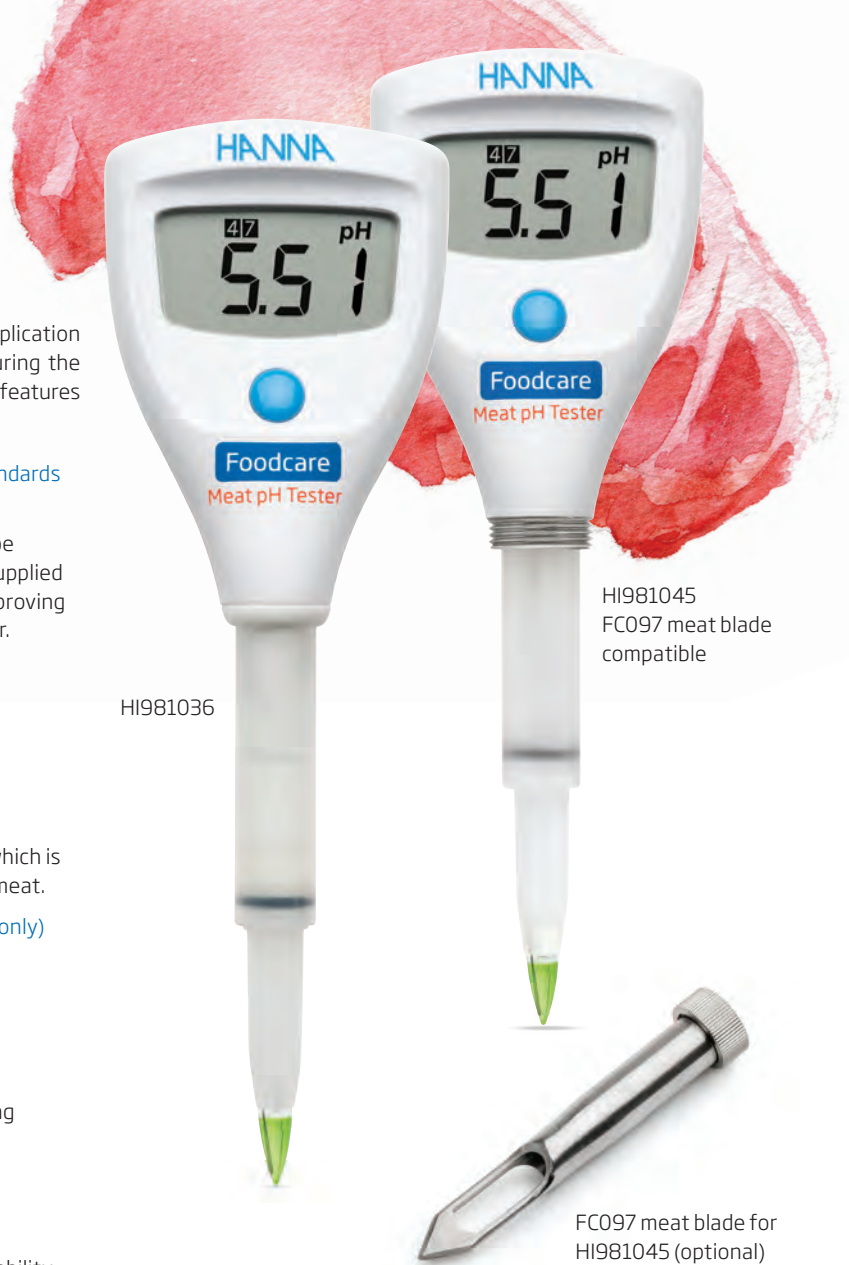

HI981036

HI981045  
FC097 meat blade  
compatible

FC097 meat blade for  
HI981045 (optional)

Specifications	HI981036	HI981045
pH	Range	0.00 to 12.00 pH
	Resolution	0.01 pH
	Accuracy (@25°C/77°F)	±0.05 pH
	Calibration	automatic, one or two-point
Additional Specifications	Temperature Compensation	automatic, 0 to 50°C (32 to 122°F)
	Glass Type	LT (low temperature)
	Blade Compatible	no                      yes, FC097
	Battery Type / Life	CR2032 Li-ion / approx. 800 hours of continuous use
	Auto-off	8 minutes, 60 minutes, or disabled
	Environment	0 to 50°C (32 to 122°F); RH 95% max
	Dimensions	51 x 148 x 21 mm (2 x 5.8 x 0.9")
	Weight	45 g (1.58 oz.)
Ordering Information	HI981036 and HI981045 (with thread) are supplied with pH 4.01 buffer solution sachets (2), pH 7.01 buffer solution sachets (2), electrode cleaning solution sachets (2), gelled bridge electrolyte, electrode storage solution, CR2032 3V Li-ion battery, quality certificate, and instruction manual.	
Accessories	FC097 stainless steel meat blade for HI981045	



## Foodcare

HI981038

### Bread and Dough pH Tester

with specialized probe

The HI981038 Foodcare Bread and Dough pH tester is an application specific designed pH tester for the measurement of pH during the dough and bread making process. This tester offers many advanced features including a pH electrode designed specifically for bread and dough.

- **pH Electrode with open junction**
  - The pH electrode of this tester uses an open outer junction design. The open junction is more resistant to clogging when the probe is inserted into solids and semisolids than pH electrodes that use ceramic or other porous materials.
- **Low temperature (LT) glass**
  - The pH glass tip uses a special low temperature (LT) glass formulation with a lower resistance of approximately 50 Megaohms compared to general purpose (GP) with a resistance of about 100 Megaohms. This is beneficial when measuring food products at lower temperatures in order to have the ideal resistance for the measuring circuit.
- **Conical tip**
  - Allows for easy penetration into solids and semisolids, which is needed when wanting to take a direct measurement in bread or dough.
- **PVDF body**
  - Polyvinylidene Fluoride (PVDF) is a food grade plastic that is resistant to most chemicals and solvents, including sodium hypochlorite. It has high abrasion resistance, mechanical strength, and resistance to ultraviolet. PVDF is also resistant to fungal growth
- **Large LCD**
  - An enhanced LCD displays the measurement reading, stability indicator, low battery indicator, and calibration tags.
- **Automatic calibration**
  - The Foodcare Bread and Dough pH Tester is calibrated automatically to one or two points. The calibration buffers are automatically recognized and after calibration the buffer values used are shown on the display.
- **Automatic temperature compensation**
- **Stability indicator**
  - An hourglass indicator is displayed on the LCD until a stable reading is obtained. Once a reading stabilizes, the indicator disappears and a reading can be taken.
- **Automatic shut-off**
  - The meter can be set to automatically turn off after 8 minutes or 60 minutes to conserve battery life in the event that the meter is left on. The auto-off feature can also be disabled.
- **Probe diagnostic**
  - During calibration the meter will display an error (Err) message as an indicator that the probe needs to be cleaned.
- **Long battery life**
  - The Foodcare Bread and Dough pH Tester has an exceptional battery life of approximately 800 hours. When the battery power is running low, the low battery indicator blinks.
- **Economical**
  - The Foodcare Bread and Dough pH Tester is an advanced meter at a price that is affordable for both the hobbyist and professional.



#### Conical tip electrode

Easy to clean electrode with a maintenance-free gel electrolyte



#### Supplied complete

Supplied complete with meter, probe, calibration solutions, and cleaning solutions.

Specifications	HI981038	
pH	Range	0.00 to 12.00 pH
	Resolution	0.01 pH
	Accuracy (@25°C/77°F)	±0.05 pH
	Calibration	automatic, one or two-point
Additional Specifications	Temperature Compensation	automatic, 0 to 50°C (32 to 122°F)
	Glass Type	LT (low temperature)
	Battery Type / Life	CR2032 Li-ion / approx. 800 hours of continuous use
	Auto-off	8 minutes, 60 minutes, or disabled
	Environment	0 to 50°C (32 to 122°F); RH 95% max
	Dimensions	50 x 129 x 21 mm (2 x 5.1 x 0.9")
	Weight	42 g (1.5 oz.)
Ordering Information	<b>HI981038</b> is supplied with pH 4.01 buffer solution sachets (2), pH 7.01 buffer solution sachets (2), electrode cleaning solution sachets (2), electrode storage solution, CR2032 3V Li-ion battery, quality certificate, and instruction manual.	

# Foodcare

HI981039

## Chocolate pH Tester

with specialized probe

The HI981039 Foodcare Chocolate pH tester is an application specific designed pH tester for the measurement of pH during the chocolate making process. This tester offers many advanced features including a pH electrode designed specifically for chocolate.

- **pH electrode with replaceable bridge electrolyte**
  - The pH electrode has an outer junction sleeve that can be removed and cleaned. Once cleaned a small amount of supplied gel electrolyte is added and the junction is refreshed improving the pH measurement and extending the life of the meter.
- **Low temperature (LT) glass**
  - The pH glass tip uses a special low temperature (LT) glass formulation with a lower resistance of approximately 50 Megaohms compared to general purpose (GP) with a resistance of about 100 Megaohms. This is beneficial when measuring food products at lower temperatures in order to have the ideal resistance for the measuring circuit.
- **Conical tip**
  - Allows for easy penetration into semisolids, which is needed when wanting to take a direct measurement in chocolate.
- **PVDF body**
  - Polyvinylidene Fluoride (PVDF) is a food grade plastic that is resistant to most chemicals and solvents, including sodium hypochlorite. It has high abrasion resistance, mechanical strength, and resistance to ultraviolet light. PVDF is also resistant to fungal growth.
- **Large LCD**
  - An enhanced LCD displays the measurement reading, stability indicator, low battery indicator, and calibration tags.
- **Automatic calibration**
  - The Foodcare Chocolate pH Tester is calibrated automatically to one or two points. The calibration buffers are automatically recognized and after calibration the buffer values used are shown on the display.
- **Automatic temperature compensation**
- **Stability indicator**
  - An hourglass indicator is displayed on the LCD until a stable reading is obtained. Once a reading stabilizes, the indicator disappears and a reading can be taken.
- **Automatic shut-off**
  - The meter can be set to automatically turn off after 8 minutes or 60 minutes to conserve battery life in the event that the meter is left on. The auto-off feature can also be disabled.
- **Probe diagnostic**
  - During calibration the meter will display an error (Err) message as an indicator that the probe needs to be cleaned.
- **Long battery life**
  - The Foodcare Chocolate pH Tester has an exceptional battery life of approximately 800 hours. When the battery power is running low, the low battery indicator blinks.
- **Economical**
  - The Foodcare Chocolate pH Tester is a fully featured meter at a price that is affordable for both the hobbyist and professional.



Removable sleeve to extend probe life



Supplied complete

Supplied complete with meter, probe, calibration solutions, and cleaning solutions.

### Specifications

HI981039

pH	Range	0.00 to 12.00 pH
	Resolution	0.01 pH
	Accuracy (@25°C/77°F)	±0.05 pH
	Calibration	automatic, one or two-point
Additional Specifications	Temperature Compensation	automatic, 0 to 50°C (32 to 122°F)
	Glass Type	LT (low temperature)
	Battery Type / Life	CR2032 Li-ion / approx. 800 hours of continuous use
	Auto-off	8 minutes, 60 minutes, or disabled
	Environment	0 to 50°C (32 to 122°F); RH 95% max
	Dimensions	51 x 148 x 21 mm (2 x 5.8 x 0.9")
	Weight	45 g (1.6 oz.)
<b>Ordering Information</b>	<b>HI981039</b> is supplied with pH 4.01 buffer solution sachets (2), pH 7.01 buffer solution sachets (2), electrode cleaning solution sachets (2), gelled bridge electrolyte, electrode storage solution, CR2032 3V Li-ion battery, quality certificate, and instruction manual.	

## Foodcare

HI981033

### Wine pH Tester

with specialized probe

The HI981033 Foodcare Wine pH tester is an application specific designed pH tester for the measurement of pH of grape juice, must, and wine. This tester offers many advanced features including a unique Clogging Prevention System (CPS™) that uses a movable Polyethylene (PE) sleeve for the ability to clear any clogging of the reference junction. The CPS Technology results in a much longer life than standard pH testers.

- **pH electrode with PE movable sleeve junction (CPS Technology)**
  - The pH electrode of this tester uses a PE movable sleeve as part of the outer ground glass junction. The PE material repels solids to prevent clogging. When clogging does occur the sleeve can be moved and the ground glass surface cleaned resulting in stable readings and fast response time.
- **Refillable**
  - The open junction design of the PTFE sleeve allows for a high flow rate of electrolyte for a fast and steady reading. The sleeve can be moved to expose the fill hole for reference electrolyte. The ability to refill the probe extends the life of the electrode.
- **Low temperature (LT) glass**
  - The pH glass tip uses a special low temperature (LT) glass formulation with a lower resistance of approximately 50 Megaohms compared to general purpose (GP) with a resistance of about 100 Megaohms. This is beneficial when measuring samples at lower temperatures in order to have the ideal resistance for the measuring circuit.
- **Domed tip**
  - Allows for large surface area to be in contact with the wine sample.
- **Glass body**
  - A glass body is easy to clean and stain resistant.
- **Large LCD**
  - An enhanced LCD displays the measurement reading, stability indicator, low battery indicator, and calibration tags.
- **Automatic calibration**
  - The Foodcare Wine pH Tester is calibrated automatically to one or two points. The calibration buffers are automatically recognized and after calibration the buffer values used are shown on the display.
- **Automatic temperature compensation**
- **Stability indicator**
  - An hourglass indicator is displayed on the LCD until a stable reading is obtained. Once a reading stabilizes, the indicator disappears and a reading can be taken.
- **Automatic shut-off**
  - The meter can be set to automatically turn off after 8 minutes or 60 minutes to conserve battery life.
- **Probe diagnostic**
  - During calibration the meter will display an error (Err) message as an indicator that the probe needs to be cleaned.
- **Long battery life**
  - The Foodcare Wine pH Tester has an exceptional battery life of approximately 800 hours. When the battery power is running low, a low battery indicator is displayed.

### Clogging Prevention System (CPS) technology

Moveable, anti-clogging PE sleeve that maintains stability and fast response



### Supplied complete

Supplied complete with meter, probe, calibration solutions, and cleaning solutions

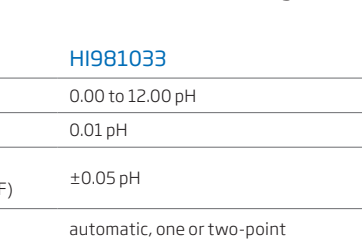

Specifications	HI981033	
pH	Range	0.00 to 12.00 pH
	Resolution	0.01 pH
	Accuracy (@25°C/77°F)	±0.05 pH
	Calibration	automatic, one or two-point
Additional Specifications	Temperature Compensation	automatic, -5 to 60°C (23 to 140°F)
	Glass Type	LT (low temperature)
	Battery Type / Life	CR2032 Li-ion / approx. 800 hours of continuous use
	Auto-off	8 minutes, 60 minutes, or disabled
	Environment	0 to 50°C (32 to 122°F); RH 95% max
	Dimensions	51 x 157 x 21 mm (2 x 6.2 x 0.9")
	Weight	46 g (1.6 oz.)
Ordering Information	<p><b>HI981033</b> is supplied with pH 3.00 buffer solution sachets (2), pH 7.01 buffer solution sachets (2), electrode cleaning solution sachets for wine stains (1) and deposits (1), electrolyte fill solution, electrode storage solution, refilling pipette, CR2032 3V Li-ion battery, quality certificate, and instruction manual.</p>	

## Foodcare

HI981031

### Beer pH Tester

with specialized probe

The HI981031 Beer pH tester is an application specific designed pH tester for the measurement of pH during the brewing process. This tester offers many advanced features including an application specific pH electrode for measuring the pH of mash, cooled wort, and beer samples with a temperature up to 80°C (176°F).

- **Titanium body**
  - A titanium body offers additional protection as compared to traditional glass body pH probes.
- **Flat tip pH sensor**
  - The flat tip sensor allows easy cleaning of the pH sensing surface as compared to rounded bulbs as solids from mash and cooled wort collect on the surface.
- **Large LCD**
  - An enhanced LCD displays the measurement reading, stability indicator, low battery indicator, and calibration tags.
- **Automatic calibration**
  - The Foodcare Beer pH Tester is calibrated automatically to one or two points. The calibration buffers are automatically recognized and after calibration the buffer values used are shown on the display as a tag.
- **Automatic temperature compensation**
- **Stability indicator**
  - An hourglass indicator is displayed on the LCD until a stable reading is obtained. Once a reading stabilizes, the indicator disappears and a reading can be taken.
- **Automatic shut-off**
  - The meter can be set to automatically turn off after 8 minutes or 60 minutes to conserve battery life in the event that the meter is left on. The auto-off feature can also be disabled.
- **Probe diagnostic**
  - During calibration the meter will display an error (Err) message as an indicator that the probe needs to be cleaned.
- **Long battery life**
  - The Foodcare Beer pH Tester has an exceptional battery life of approximately 800 hours. When the battery power is running low, the low battery indicator blinks.
- **Economical**
  - The Foodcare Beer pH Tester is a fully featured meter at a price that is affordable for both the home brewer to professional brewmaster looking to start experimenting with pH measurements.



Titanium body

Specialized flat tip pH sensor

#### Supplied complete

Supplied complete with meter, probe, calibration solutions, and cleaning solutions

Specifications	HI981031	
pH	Range	0.00 to 12.00 pH
	Resolution	0.01 pH
	Accuracy (@25°C/77°F)	±0.05 pH
	Calibration	automatic, one or two-point
Additional Specifications	Temperature Compensation	automatic, 0 to 50°C (32 to 122°F)
	Glass Type	LT (low temperature)
	Battery Type / Life	CR2032 Li-ion / approx. 800 hours of continuous use
	Auto-off	8 minutes, 60 minutes, or disabled
	Environment	0 to 50°C (32 to 122°F); RH 95% max
	Dimensions	51 x 165 x 21 mm (2 x 6.5 x 0.9")
	Weight	58 g (2 oz.)
	<b>Ordering Information</b>	<b>HI981031</b> is supplied with pH 4.01 buffer solution sachets (2), pH 7.01 buffer solution sachets (2), electrode cleaning solution sachets (2), electrode storage solution, CR2032 3V Li-ion battery, quality certificate, and instruction manual.

HI981037

## Skin & Scalp pH Tester

with specialized probe

The HI981037 is a tester made specifically for measuring the pH of the skin and scalp. This tester uses a flat tip electrode with an open reference junction that allows for the direct contact surface measurement of pH. An open junction design is necessary in order to permit contact between the internal reference cell and the surface of the skin.

The pH of the skin is slightly acidic at a pH of approximately 5. Having an acidic pH helps to protect against harmful bacteria and fungi while promoting the growth of beneficial bacteria. Disruption of the skin pH can lead to or amplify skin disorders. Many skin care products and soaps are made to be pH balanced so that the product does not alter the pH of skin outside a desirable range.

### Electrode features:

- **Flat tip pH Electrode**
  - A flat tip electrode allows for the direct pH measurement of a surface.
- **Open reference junction**
  - The pH electrode of this tester uses an open outer junction design. The open junction provides for a direct contact with the skin or scalp for the electrode to work with minimal moisture for a stable measurement.
- **Glass Body**
  - The glass body of the pH electrode is not porous and can be cleaned and disinfected.

### Tester features:

- **Large LCD**
  - Displays the measurement reading, stability indicator, low battery indicator, and calibration tags.
- **Automatic Calibration**
  - This pH tester is calibrated automatically to one or two points. Buffers are recognized automatically and after calibration, buffer values used are shown on the display.
- **Automatic temperature compensation**
- **Stability Indicator**
  - An hourglass indicator is displayed on the LCD until a stable reading is obtained.
- **Automatic Shut-off**
  - The meter can be set to automatically turn off after 8 minutes or 60 minutes to conserve battery life in the event that the meter is left on. The auto-off feature can also be disabled.
- **Probe Diagnostic**
  - During calibration the meter will display an error (Err) message as an indicator that the probe needs to be cleaned.
- **Long Battery Life**
  - The skin & scalp pH tester has an exceptional battery life of approximately 800 hours. When the battery power is running low, the low battery indicator blinks.



### Flat tip electrode

Easy to clean electrode with a maintenance-free gel electrolyte



### Supplied complete

Supplied complete with meter, probe, calibration solutions, and cleaning solutions.

Specifications	HI981037	
pH	Range	0.00 to 12.00 pH
	Resolution	0.01 pH
	Accuracy (@25°C/77°F)	±0.05 pH
	Calibration	automatic, one or two-point
Additional Specifications	Temperature Compensation	automatic, 0 to 50°C (32 to 122°F)
	Battery Type / Life	CR2032 Li-ion / approx. 800 hours of continuous use
	Auto-off	8 minutes, 60 minutes, or disabled
	Environment	0 to 50°C (32 to 122°F); RH 95% max
	Dimensions	51 x 124 x 21 mm (2 x 4.9 x 0.9")
	Weight	46 g (1.6 oz.)
Ordering Information	HI981037 is supplied with pH 4.01 buffer solution sachet (2), pH 7.01 buffer solution sachet (2), cleaning and disinfection solution sachet for skin residuals, electrode cleaning solution sachet for skin grease and sebum, electrode storage solution (13 mL), CR2032 3V Li-ion battery, quality certificate, and instruction manual.	

HI98120 · HI98121

# ORP and pH/ORP Testers

- Automatic one or two-point pH calibration (HI98121)
- Waterproof
  - Waterproof and designed to float
- ATC
  - Automatic Temperature Compensation (HI98121)
- HOLD feature
  - HOLD button to freeze readings on the display
- Battery indicator
  - Battery life indicator at startup

The HI98120 is a waterproof ORP and temperature meter, while the HI98121 measures pH, ORP, and temperature. The housing of these testers has been completely sealed against humidity and is designed to float.

Electrode replacement with the stainless steel round connector means there are no pins to bend or break during replacement.



HI73120 replaceable ORP cartridge for HI98120.



HI73127 replaceable pH cartridge for HI98121.



HI98120

HI98121

## LCD Display Features



### On-screen battery life

LCD indicates the percentage of battery power remaining upon startup.



### HOLD function

The HOLD function “freezes” the LCD display temporarily.



### Standard or N.I.S.T buffer calibration (HI98121)

Automatic calibration is performed with two sets of memorized buffers for greater accuracy.



### Replaceable pH (HI98121) or ORP (HI98120) electrode cartridge

The easy-to-replace electrode cartridge features a sturdy, snap-in connector with no pins which could bend or break.



### Exposed temperature sensor

An exposed temperature sensor allows for rapid automatic temperature compensated pH measurements.



### Pocket clip

A pocket clip is featured on the back of these testers.

Specifications	HI98120	HI98121	
pH	Range	-	-2.00 to 16.00 pH
	Resolution	-	0.01 pH
	Accuracy	-	±0.05 pH
ORP	Range	± 1000 mV	± 1000 mV
	Resolution	1 mV	1 mV
	Accuracy	±2 mV	±2 mV
Temperature	Range	-5.0 to 60.0°C / 23.0 to 140.0°F	-5.0 to 60.0°C / 23.0 to 140.0°F
	Resolution	0.1°C / 0.1°F	0.1°C / 0.1°F
	Accuracy	±0.5°C / ±1°F	±0.5°C / ±1°F
Additional Specifications	ORP Calibration	factory calibrated	factory calibrated
	pH Calibration	-	automatic, one or two-point with two sets of standard buffers (pH 4.01 / 7.01 / 10.01 or 4.01 / 6.86 / 9.18)
	Temperature Compensation	-	automatic for pH readings
	Electrodes	HI73120 replaceable ORP electrode (included)	HI73127 replaceable pH electrode (included); fixed ORP sensor
	Battery Type / Life	1.5V (4) / approximately 250 hours of continuous use; auto-off after 8 minutes of non-use	
	Environment	-5 to 50°C (23 to 122°F); RH max 100%	
	Dimensions / Weight	163 x 40 x 26 mm (6.4 x 1.6 x 1.0”) / 100 g (3.5 oz.)	
Ordering Information	<p><b>HI98120</b> (ORP) is supplied with HI73120 ORP electrode, HI73128 electrode removal tool, 470 mV ORP test solution sachets (6), batteries, and instructions.</p> <p><b>HI98121</b> (ORP/pH) is supplied with HI73127 pH electrode, HI73128 electrode removal tool, pH 4.01 buffer solution sachet, pH 7.01 buffer solution sachet, 470 mV ORP test solution sachets (2), pH electrode cleaning solution sachet, pH electrode storage solution sachet, batteries, and instructions.</p>		



### Protective cap

The protective cap features an internal cup that can be filled with storage solution to keep the sensor moist.

HI981204 • HI981214

## ORP and pH/ORP Testers

- Automatic one or two-point pH calibration (HI981214)
- Waterproof
  - Waterproof and designed to float
- ATC
  - Automatic Temperature Compensation
- HOLD feature
  - HOLD button to freeze readings on the display
- Battery indicator
  - Battery life indicator at startup

The HI981204 is a waterproof ORP and temperature meter, while the HI981214 measures pH, ORP, and temperature. The housing of these testers has been completely sealed against humidity and is designed to float.

Electrode replacement with the stainless steel round connector means there are no pins to bend or break during replacement.



HI73120 replaceable ORP cartridge for HI981204.



HI73127 replaceable pH cartridge for HI981214.



Specifications	HI981204	HI981214	
pH	Range	-	-2.00 to 16.00 pH
	Resolution	-	0.01 pH
	Accuracy	-	±0.05 pH
ORP	Range	± 1000 mV	± 1000 mV
	Resolution	1 mV	1 mV
	Accuracy	±2 mV	±2 mV
Temperature	Range	-5.0 to 60.0°C / 23.0 to 140.0°F	-5.0 to 60.0°C / 23.0 to 140.0°F
	Resolution	0.1°C / 0.1°F	0.1°C / 0.1°F
	Accuracy	±0.5°C / ±1°F	±0.5°C / ±1°F
Additional Specifications	ORP Calibration	factory calibrated	factory calibrated
	pH Calibration	-	automatic, one or two-point with two sets of standard buffers (pH 4.01 / 7.01 / 10.01 or 4.01 / 6.86 / 9.18)
	Temperature Compensation	-	automatic for pH readings
	Electrodes	HI73120 replaceable ORP electrode (included)	HI73127 replaceable pH electrode (included); fixed ORP sensor
	Battery Type / Life	1.5V (4) / approximately 250 hours of continuous use; auto-off after 8 minutes of non-use	
	Environment	-5 to 50°C (23 to 122°F); RH max 100%	
Dimensions / Weight	163 x 40 x 26 mm (6.4 x 1.6 x 1.0") / 100 g (3.5 oz.)		
Ordering Information	<p><b>HI981204</b> (ORP) is supplied with HI73120 ORP electrode, HI73128 electrode removal tool, 470 mV ORP test solution sachets (6), batteries, and instructions.</p> <p><b>HI981214</b> (ORP/pH) is supplied with HI73127 pH electrode, HI73128 electrode removal tool, pH 4.01 buffer solution sachet, pH 7.01 buffer solution sachet, 470 mV ORP test solution sachets (2), pH electrode cleaning solution sachet, pH electrode storage solution sachet, batteries, and instructions.</p>		





Supplied in a carrying case with calibration solutions.

HI98319

## Low and High Range Salinity Tester

- Waterproof
- Automatic temperature compensation (ATC)
- Dual pin graphite EC probe

The HI98319 is a compact, waterproof, pocket-sized marine Salinity tester designed for the measurement of salinity in salt water aquariums, aquaculture, brackish water, or other salt-water bodies.

HI98325 features amperometric graphite electrodes that provide improved repeatability in measurements as the pins do not oxidize. Additionally, this tester offers an exposed temperature sensor for faster response times and automatic single-point calibration.

Salinity results are displayed in either parts per thousand (ppt), Practical Salinity Units (PSU), or Specific Gravity (S.G.).

### Specifications

		HI98319	
		Low Range	High Range
ppt (g/L)	Range	0.00 to 10.00	0.0 to 70.0
	Resolution	0.01	0.1
	Accuracy	±2.0 ppt	±1.0 (0.0 to 40.0); ±2.0 (40.0 to 70.0)
PSU	Range	0.00 to 10.00	0.0 to 70.0
	Resolution	0.01	0.1
	Accuracy	±2.0 ppt	±1.0 (0.0 to 40.0); ±2.0 (40.0 to 70.0)
S.G. (Specific gravity)	Range	1.000 – 1.007	1.000 to 1.041
	Resolution	0.001	0.001
	Accuracy	±0.001	±0.001
Temperature	Range	0.0 to 50.0 °C (32.0 to 122.0 °F)	
	Resolution	0.1 °C / 0.1 °F	
	Accuracy	±0.5 °C / ±1.0 °F	
Method	ppt	International Oceanographic Tables, 1966	
	PSU	Standard Methods for the Examination of Water and Wastewater, 2520 B, Electrical Conductivity Method	
	S.G.	Standard Methods for the Examination of Water and Wastewater, 2520 C, Density Method	
Additional Specifications	Calibration Solution	HI70023 (5.00 ppt); HI70024 (35.00 ppt)	
	Calibration	automatic, single point (5.00 or 35.00 ppt)	
	Temperature Compensation	automatic from 5.0 to 50.0 °C (41.0 to 122.0 °F)	
	Battery type	CR2032 3V Lithium-ion	
	Battery life	approximately 100 hours of continuous use	
	Auto-off	user selectable: after 8 min., 60 min., or disabled	
	Environment	0 to 50 °C (32 °C to 122 °F); RH max 100%	
Dimensions	160 x 40 x 17 mm (6.3 x 1.6 x 0.7")		
Weight	68 g (2.4 oz.) without battery		
Ordering Information	<b>HI98319</b> is supplied with 5.00 ppt salinity calibration standard solution, 20 mL sachet (2 pcs.), 35.00 ppt salinity calibration standard solution, 20 mL sachet (2 pcs.), 3V Lithium battery - CR2032, installed (1 pc.), storage / protection sleeve, instruction manual, and instrument quality certificate.		



Exposed temperature sensor for faster response times



Watertight seal

An easily removable cover provides access to the battery compartment.

# GroLine®

HI98325

## Low and High Range Salinity Tester

- Waterproof
- Automatic temperature compensation (ATC)
- Dual pin graphite EC probe

The HI98325 is a compact, pocket-sized, salinity tester designed to measure salinity levels in irrigation water.

This waterproof tester is the ideal tool in agricultural areas such as coffee farms, orange farms, watermelon farms, tea and rice farms where level salinity values are vital to crop management. Additionally, the HI98325 is useful in industries such as printing, textiles, food and beverage as well as research and environmental protection institutes where low level salinity values are needed.

HI98325 features amperometric graphite electrodes that provide improved repeatability in measurements as the pins do not oxidize. Additionally, this tester offers an exposed temperature sensor for faster response times and automatic single-point calibration.

Salinity results are displayed in either parts per (g/L), Practical Salinity Units (PSU), or Specific Gravity (S.G.).



Exposed temperature sensor for faster response times



Watertight seal

An easily removable cover provides access to the battery compartment.



Water salinity classes based on salinity levels

Non-saline	< 0.75 mg/L	
Moderately saline	0.75 to 1.5 mg/L	affects crop productivity of salt-sensitive trees
Highly saline	1.5 to 3.5 mg/L	affects most trees
Severely saline	3.5 to 6.5 mg/L	affects salt-tolerant trees

### Specifications

		HI98325	
		Low Range	High Range
ppt (g/L)	Range	0.00 to 10.00	0.0 to 70.0
	Resolution	0.01	0.1
	Accuracy	±2.0 ppt	±1.0 (0.0 to 40.0); ±2.0 (40.0 to 70.0)
PSU	Range	0.00 to 10.00	0.0 to 70.0
	Resolution	0.01	0.1
	Accuracy	±2.0 ppt	±1.0 (0.0 to 40.0); ±2.0 (40.0 to 70.0)
S.G. (Specific gravity)	Range	1.000 to 1.007	1.000 to 1.041
	Resolution	0.001	0.001
	Accuracy	±0.001	±0.001
Temperature	Range	0.0 to 50.0 °C (32.0 to 122.0 °F)	
	Resolution	0.1 °C / 0.1 °F	
	Accuracy	±0.5 °C/±1.0 °F	
Method	ppt	International Oceanographic Tables, 1966	
	PSU	Standard Methods for the Examination of Water and Wastewater, 2520 B, Electrical Conductivity Method	
	S.G.	Standard Methods for the Examination of Water and Wastewater, 2520 C, Density Method	
Additional Specifications	Calibration Solution	HI70023 (5.00 ppt); HI70024 (35.00 ppt)	
	Calibration	automatic, single point (5.00 or 35.00 ppt)	
	Temperature Compensation	automatic from 5.0 to 50.0 °C (41.0 to 122.0 °F)	
	Battery type	CR2032 3V Lithium-ion	
	Battery life	approximately 100 hours of continuous use	
	Auto-off	user selectable: after 8 min., 60 min., or disabled	
	Environment	0 to 50 °C (32 °C to 122 °F); RH max 100%	
	Dimensions	160 x 40 x 17 mm (6.3 x 1.6 x 0.7")	
Weight	68 g (2.4 oz.) without battery		
Ordering Information	HI98325 is supplied with 5.00 ppt salinity calibration standard solution, 20 mL sachet (2 pcs.), 35.00 ppt salinity calibration standard solution, 20 mL sachet (2 pcs.), 3V Lithium battery - CR2032, installed (1 pc.), storage / protection sleeve, instruction manual, and instrument quality certificate.		



HI98326 (DiST®9)

## Low and High Range Salinity Tester

- Waterproof
- Automatic temperature compensation (ATC)
- Dual pin graphite EC probe

The HI98326 (DiST 9) is a compact, waterproof, pocket-sized Salinity tester designed for the measurement of salinity in salt water aquariums, aquaculture, brackish water, or other salt-water bodies.

HI98326 features amperometric graphite electrodes that provide improved repeatability in measurements as the pins do not oxidize. Additionally, this tester offers an exposed temperature sensor for faster response times and automatic single-point calibration.

Salinity results are displayed in either parts per thousand (ppt), Practical Salinity Units (PSU), or Specific Gravity (S.G.).

### Specifications

#### HI98326 (DiST 9)

		Low Range	High Range
ppt (g/L)	Range	0.00 to 10.00	0.0 to 70.0
	Resolution	0.01	0.1
	Accuracy	±2.0 ppt	±1.0 (0.0 to 40.0); ±2.0 (40.0 to 70.0)
PSU	Range	0.00 to 10.00	0.0 to 70.0
	Resolution	0.01	0.1
	Accuracy	±2.0 ppt	±1.0 (0.0 to 40.0); ±2.0 (40.0 to 70.0)
S.G. (Specific gravity)	Range	1.000 - 1.007	1.000 to 1.041
	Resolution	0.001	0.001
	Accuracy	±0.001	±0.001
Temperature	Range	0.0 to 50.0 °C (32.0 to 122.0 °F)	
	Resolution	0.1 °C / 0.1 °F	
	Accuracy	±0.5 °C/±1.0 °F	
Method	ppt	International Oceanographic Tables, 1966	
	PSU	Standard Methods for the Examination of Water and Wastewater, 2520 B, Electrical Conductivity Method	
	S.G.	Standard Methods for the Examination of Water and Wastewater, 2520 C, Density Method	
Additional Specifications	Calibration Solution	HI70023 (5.00 ppt); HI70024 (35.00 ppt)	
	Calibration	automatic, single point (5.00 or 35.00 ppt)	
	Temperature Compensation	automatic from 5.0 to 50.0 °C (41.0 to 122.0 °F)	
	Battery type	CR2032 3V Lithium-ion	
	Battery life	approximately 100 hours of continuous use	
	Auto-off	user selectable: after 8 min., 60 min., or disabled	
	Environment	0 to 50 °C (32 °C to 122 °F); RH max 100%	
	Dimensions	160 x 40 x 17 mm (6.3 x 1.6 x 0.7")	
Weight	68 g (2.4 oz.) without battery		
Ordering Information	HI98326 (DiST 9) is supplied with 5.00 ppt salinity calibration standard solution, 20 mL sachet (2 pcs.), 35.00 ppt salinity calibration standard solution, 20 mL sachet (2 pcs.), 3V Lithium battery - CR2032, installed (1 pc.), storage / protection sleeve, instruction manual, and instrument quality certificate.		



Exposed temperature sensor for faster response times



Watertight seal

An easily removable cover provides access to the battery compartment.

HI98311 · HI98312

## EC/TDS and Temperature Testers

- **Waterproof**
  - Waterproof and designed to float
- **Automatic Temperature Compensation (ATC)**
- **HOLD feature**
  - HOLD button to freeze readings on the display
- **Battery Error Prevention System (BEPS)**
  - Alerts the user of low battery power that could adversely affect readings

When the original DiST® (Dissolved Solids Tester) was first introduced, conductivity (EC) and total dissolved solids (TDS) measurements became easy and affordable. The DiST's ease of use, in combination with its affordability, made it the standard in EC and TDS measurement. Hanna continues the standard in EC and TDS testing with the DiST®5 and DiST®6.

These testers include features such as: a replaceable graphite electrode, adjustable TDS ratio, °C or °F measurement, Automatic Temperature Compensation (ATC) with adjustable  $\beta$ , battery level indicator, stability indicator, automatic shut-off, and automatic calibration.



The graphite conductivity electrode offers greater accuracy by resisting contamination by salt deposits in the sample.

All of these features are packed in a floating, waterproof casing. These 3-in-1 testers are unmatched in EC/TDS and temperature measurements.



## LCD Display Features



### On-screen battery life

LCD indicates the percentage of battery power remaining upon startup.

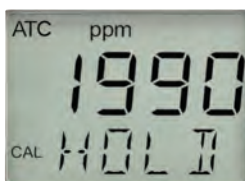

### HOLD function

The HOLD function “freezes” the LCD display temporarily.



### Instability & ATC indicators

Ensures reliable EC and TDS measurements. ATC symbol is shown when active.



### Adjustable temperature coefficient factor

Users can choose between different factors ( $\beta$ ) for precise temperature compensated measurements.



### Adjustable TDS conversion factor

For measurement accuracy, users can choose between a range of conductivity to TDS conversion factors.



### Exposed temperature sensor

An exposed temperature sensor allows for rapid automatic temperature compensated measurements.

Specifications	HI98311 (DiST®5)	HI98312 (DiST®6)	
EC	Range	0 to 3999 $\mu$ S/cm	0.00 to 20.00 mS/cm
	Resolution	1 $\mu$ S/cm	0.01 mS/cm
	Accuracy	$\pm$ 2% F.S.	$\pm$ 2% F.S.
TDS	Range	0 to 2000 ppm (mg/L)	0.00 to 10.00 ppt (g/L)
	Resolution	1 ppm (mg/L)	0.01 ppt (g/L)
	Accuracy	$\pm$ 2% F.S.	$\pm$ 2% F.S.
Temperature	Range	0.0 to 60.0°C / 32.0 to 140.0°F	0.0 to 60.0°C / 32.0 to 140.0°F
	Resolution	0.1°C / 0.1°F	0.1°C / 0.1°F
	Accuracy	$\pm$ 0.5°C / $\pm$ 1°F	$\pm$ 0.5°C / $\pm$ 1°F
Additional Specifications	Calibration	automatic, one point at 1413 $\mu$ S/cm or 1382 ppm (mg/L)	automatic, one point at 12.88 mS/cm or 6.44 ppt (g/L)
	TDS Conversion Factor	adjustable from 0.45 to 1.00	
	Temperature Compensation	automatic, with $\beta$ adjustable from 0.0 to 2.4% / °C	
	Probe	HI73311 replaceable EC/TDS graphite electrode (included)	
	Environment	0 to 50°C (32 to 122°F); RH max 100%	
	Battery Type / Life	1.5V (4) / approx. 100 hours of continuous use; auto-off after 8 minutes of non-use	
	Dimensions / Weight	163 x 40 x 26 mm (6.4 x 1.6 x 1.0") / 100 g (3.5 oz.)	
Ordering Information	<b>HI98311</b> (DiST®5) is supplied with HI73311 EC/TDS probe, HI73128 probe removal tool, 1413 $\mu$ S/cm conductivity standard sachets (3), 1382 ppm TDS standard sachets (3), batteries, and instructions.		
	<b>HI98312</b> (DiST®6) is supplied with HI73311 EC/TDS probe, HI73128 probe removal tool, 12880 $\mu$ S/cm conductivity standard sachets (3), 6.44 ppt TDS standard sachets (3), batteries, and instructions.		



### Replaceable graphite electrode

An easy-to-replace graphite electrode with a sturdy, snap-in connector means there are no pins to bend or break.



### Pocket clip

A pocket clip is featured on the back.

HI983124

## EC/TDS and Temperature Tester

- **Waterproof**
  - Waterproof and designed to float
- **Automatic Temperature Compensation (ATC)**
- **HOLD feature**
  - HOLD button to freeze readings on the display
- **Battery Error Prevention System (BEPS)**
  - Alerts the user of low battery power that could adversely affect readings



### Replaceable graphite electrode

An easy-to-replace graphite electrode with a sturdy, snap-in connector means there are no pins to bend or break.



### Pocket clip

A pocket clip is featured on the back.



### Specifications

### HI983124

EC	Range	0.00 to 20.00 mS/cm
	Resolution	0.01 mS/cm
	Accuracy	±2% F.S.
TDS	Range	0.00 to 10.00 ppt (g/L)
	Resolution	0.01 ppt (g/L)
	Accuracy	±2% F.S.
Temperature	Range	0.0 to 60.0°C / 32.0 to 140.0°F
	Resolution	0.1°C / 0.1°F
	Accuracy	±0.5°C / ±1°F
Additional Specifications	Calibration	automatic, one point at 12.88 mS/cm or 6.44 ppt (g/L)
	TDS Conversion Factor	adjustable from 0.45 to 1.00
	Temperature Compensation	automatic, with $\beta$ adjustable from 0.0 to 2.4% / °C
	Probe	HI73311 replaceable EC/TDS graphite electrode (included)
	Environment	0 to 50°C (32 to 122°F); RH max 100%
	Battery Type / Life	1.5V (4) / approx. 100 hours of continuous use; auto-off after 8 minutes of non-use
	Dimensions	163 x 40 x 26 mm (6.4 x 1.6 x 1.0")
Weight	100 g (3.5 oz.)	
<b>Ordering Information</b>	<b>HI983124</b> is supplied with HI73311 EC/TDS probe, HI73128 probe removal tool, 12880 $\mu$ S/cm conductivity standard sachets (3), 6.44 ppt TDS standard sachets (3), batteries, and instructions.	

HI98318

## EC/TDS Tester

- Waterproof
- Automatic temperature compensation (ATC)
- Automatic one-point EC calibration
- Measurement stability indicator

The GroLine® waterproof EC/TDS tester is ideal for hydroponics, greenhouses, or anywhere you need quick and accurate conductivity measurements.



Exposed temperature sensor for faster response times



### Watertight seal

An easily removable cover provides access to the battery compartment.



Supplied in a carrying case with calibration solutions.



### Specifications

	HI98318	
EC/TDS	Range	0.00 to 6.00 mS/cm; 0 to 3000 ppm (0.5); 0 to 4000 ppm (0.7)
	Resolution	0.01 mS/cm; 10 ppm (0.5); 10 ppm (0.7)
	Accuracy (@25°C/77°F)	±2% F.S.
	Calibration	automatic, one-point (1.41 mS)
	Quick Calibration	one-point calibration using HI5036 or HI50036P Quick Cal calibration solution
	TDS Conversion Factor (CF)*	0.5 (500 ppm) or 0.7 (700 ppm)
Temperature	Range	0.0 to 50.0°C/32.0 to 122.0°F
	Resolution	0.1°C/0.1°F
	Accuracy (@25°C/77°F)	±0.5°C/±1°F
Additional Specifications	Temperature Compensation	automatic, 0.0 to 50.0°C (32 to 122°F)
	Battery Type / Life	CR2032 Li-ion (Included) / approx. 250 hours of continuous use
	Auto-off	8 minutes, 60 minutes, or can be disabled
	Environment	0 to 50°C (32 to 122°F); RH 100% max
	Dimensions	160 x 40 x 17 mm (6.3 x 1.6 x 0.7")
	Weight	75 g (2.6 oz.)
<b>Ordering Information</b>	<b>HI98318</b> GroLine EC/TDS tester is supplied with Quick Cal calibration sachets (4), battery, storage cap, instruction manual, and quality certificate.	

DiST®: HI98301 · HI98302 · HI98303 HI98304

## EC and TDS Testers

- Waterproof
- Automatic temperature compensation (ATC)
- Automatic one-point calibration
- Measurement stability indicator
- Temperature measurement

The DiST® family of testers is widely used for monitoring EC/TDS in drinking water, water conditioning, reverse osmosis, cooling towers, wastewater, laboratories, agriculture, aquaculture and aquariums, hydroponics, and the printing industry.

These testers feature an amperometric graphite electrode that provides improved repeatability in measurements, since they do not oxidize. An amperometric measurement of EC/TDS is based on Ohm's Law,  $I = V/R$ , where R depends on the distance between two pins and their surface. Oxidation changes both the distance and surface, which will directly affect accuracy. DiST® non-oxidizing graphite pins are able to provide an optimal surface for accurate, dependable results.

When calibration is needed, simply submerge the electrode tip into calibration solution and the meter will auto calibrate.



Supplied in a carrying case with buffer and cleaning solutions.



Specifications	HI98301 (DiST®1)	HI98302 (DiST®2)	HI98303 (DiST®3)	HI98304 (DiST®4)	
TDS	Range	0 to 2000 ppm (mg/L)	0.00 to 10.00 ppt (g/L)	-	
	Resolution	1 ppm (mg/L)	0.01 ppt (g/L)	-	
	Accuracy (@25°C/77°F)	±2% F.S.	-	-	
	TDS Factor	0.5	0.5	-	
EC	Range	-	-	0 to 2000 µS/cm	
	Resolution	-	-	1 µS/cm	
	Accuracy (@25°C/77°F)	-	-	±2% F.S.	
Temperature	Range	0.0 to 50.0°C/32.0 to 122.0°F			
	Resolution	0.1°C / 0.1°F			
	Accuracy (@25°C/77°F)	±0.5°C / ±1.0°F			
Additional Specifications	Calibration Solution	HI70032: 1382 ppm	HI70038: 6.44 ppt	HI70031: 1413 mS/cm	
	Calibration	automatic, one-point			
	Temperature Compensation	automatic from 0 to 50°C (32 to 122°F)			
	Battery Type / Life	CR2032 3V Li-ion / approx. 250 hours of continuous use			
	Environment	0 to 50°C (32 to 122°F); RH 100% max			
	Dimensions	160 x 40 x 17 mm (6.3 x 1.6 x 0.7")			
	Weight	75 g (2.6 oz.)			
	Ordering Information	<p><b>HI98301</b> (DiST 1) is supplied with CR2032 battery, 1382 ppm calibration solution sachet (4), storage/protection sleeve, instruction manual, and quality certificate.</p> <p><b>HI98302</b> (DiST 2) is supplied with CR2032 battery, 6.44 ppt calibration solution sachet (4), storage/protection sleeve, instruction manual, and quality certificate.</p> <p><b>HI98303</b> (DiST 3) is supplied with CR2032 battery, 1413 µS/cm calibration solution sachet (4), storage/protection sleeve, instruction manual, and quality certificate.</p> <p><b>HI98304</b> (DiST 4) is supplied with CR2032 battery, 12.88 mS/cm calibration solution sachet (4), storage/protection sleeve, instruction manual, and quality certificate.</p>			



114 mm (4.5")  
stainless steel  
penetration probe



max immersion  
level

recommended  
immersion level

# GroLine®

HI98331 Soil Test™

## Direct Soil EC and Temperature Tester

with Built-in Stainless Steel EC Probe

- One-point calibration
- Automatic calibration to 1413  $\mu\text{S}/\text{cm}$  conductivity standard
- Automatic Temperature Compensation (ATC)
  - Samples automatically compensated for temperature variations
- Uses a fixed 2%/°C temperature correction coefficient
- Stainless steel penetration electrode
- Allows for direct measurement in soil

The Soil Test™ Direct Soil EC Tester is a rugged and reliable pocket-sized tester that offers quick and accurate readings. The Soil Test™ features a stainless steel penetration probe for direct measurement of conductivity in soils. With a compact size, single button operation, and automatic calibration, Soil Test is an excellent choice for taking direct conductivity measurements in soil.



### Battery compartment

An easily removable cover provides access to the battery compartment.



Supplied in a carrying case with probe sleeve

### Specifications

### HI98331 Soil Test™

EC	Range	0 to 4000 $\mu\text{S}/\text{cm}$ 0.00 to 4.00 mS/cm (dS/m)
	Resolution	1 $\mu\text{S}/\text{cm}$ 0.01 mS/cm (dS/m)
	Accuracy (@25°C/77°F)	$\pm 50 \mu\text{S}/\text{cm}$ (0 to 2000 $\mu\text{S}/\text{cm}$ ) $\pm 300 \mu\text{S}/\text{cm}$ (2000 to 4000 $\mu\text{S}/\text{cm}$ ) $\pm 0.05 \text{ mS}/\text{cm}$ (0.00 to 2.00 mS/cm) $\pm 0.30 \text{ mS}/\text{cm}$ (2.00 to 4.00 mS/cm)
	Calibration	automatic, one-point (1.41 mS/cm)
Temperature	Range	0.0 to 50.0°C (32.0 to 122.0°F)
	Resolution	0.1°C (0.1°F)
	Accuracy (@25°C/77°F)	$\pm 1^\circ\text{C}$ ( $\pm 1.5^\circ\text{F}$ )
Additional Specifications	Temperature Compensation	Automatic, with coefficient ( $\beta$ ) fixed @ 2%/°C
	Probe	114 mm (4.5") stainless steel penetration (fixed)
	Battery Type / Life	CR2032 Li-ion (included) / approx. 100 hours of continuous use
	Auto-off	8 minutes, 60 minutes, or can be disabled
	Environment	0 to 50°C (32 to 122°F); RH 95% max
	Dimensions	50 x 196 x 21 mm (2.0 x 7.7 x 0.9")
Weight	74 g (2.4 oz.)	
Ordering Information	<b>HI98331</b> (Soil Test) is supplied with HI73331 penetration conductivity probe, calibration screwdriver, batteries, and instructions.	



HI983024 • HI983044

## TDS and EC Testers

- Waterproof
- Automatic temperature compensation (ATC)
- Automatic one-point calibration
- Measurement stability indicator
- Temperature measurement

The Pool Line HI983024 (TDS) and HI983044 (EC) are ideal for monitoring pools and spas.

These Pool Line testers feature an amperometric graphite electrode that provides improved repeatability in measurements, since it does not oxidize. An amperometric measurement of EC/TDS is based on Ohm's Law,  $I = V/R$ , where R depends on the distance between two pins and their surface. Oxidation changes both the distance and surface, which will directly affect accuracy. The non-oxidizing graphite pins are able to provide an optimal surface for accurate, dependable results.

When calibration is needed, simply submerge the electrode tip into calibration solution and the meter will auto calibrate.



Specifications	HI983024	HI983044	
TDS	Range	0.00 to 10.00 ppt (g/L)	-
	Resolution	0.01 ppt (g/L)	-
	Accuracy (@25°C/77°F)	±2% F.S.	-
	TDS Factor	0.5	-
EC	Range	-	0.00 to 20.00 mS/cm
	Resolution	-	0.01 mS/cm
	Accuracy (@25°C/77°F)	-	±2% F.S.
Temperature	Range	0.0 to 50.0°C/32.0 to 122.0°F	
	Resolution	0.1°C / 0.1°F	
	Accuracy (@25°C/77°F)	±0.5°C / ±1.0°F	
Additional Specifications	Calibration Solution	HI70038: 6.44 ppt	HI70030: 12.88 mS/cm
	Calibration	automatic, one-point	
	Temperature Compensation	automatic from 0 to 50°C (32 to 122°F)	
	Battery Type / Life	CR2032 3V Li-ion / approx. 250 hours of continuous use	
	Environment	0 to 50°C (32 to 122°F); RH 100% max	
	Dimensions	160 x 40 x 17 mm (6.3 x 1.6 x 0.7")	
Weight	75 g (2.6 oz.)		
Ordering Information	<p><b>HI983024</b> is supplied with CR2032 battery, 6.44 ppt calibration solution sachet (4), storage/protection sleeve, instruction manual, and quality certificate.</p> <p><b>HI983044</b> is supplied with CR2032 battery, 12.88 mS/cm calibration solution sachet (4), storage/protection sleeve, instruction manual, and quality certificate.</p>		

HI98308 · HI98309

## Water Purity Testers

The HI98308 and HI98309 use a conductometric measurement to determine the purity of water.

The HI98308 Pure Water Test (PWT) enables users to check the purity of distilled or demineralized water in laboratory or industrial environments.

The HI98309 Ultra Pure Water (UPW) is an ideal tester for high purity water, which has less conductivity.

PWT is suited for fields such as printed circuit board washing, laundry, steam cleaning, checking car battery water and all areas where distilled, demineralized or pure water is used.

UPW is the first pure water tester to measure in 1/1000ths of micro-Siemens ( $\mu\text{S}$ ) and provides fast spot checks for minute traces of water contamination.

These testers are housed in a durable casing that provides excellent protection against harsh industrial environments.



Specifications		HI98308 (PWT)	HI98309 (UPW)
EC	Range	0.0 to 99.9 $\mu\text{S}/\text{cm}$	0.000 to 1.999 $\mu\text{S}/\text{cm}$
	Resolution	0.1 $\mu\text{S}/\text{cm}$	0.001 $\mu\text{S}/\text{cm}$
	Accuracy	$\pm 2\%$ F.S.	$\pm 2\%$ F.S.
Additional Specifications	Calibration	manual, one point	factory calibrated
	Temperature Compensation	automatic from 0 to 50°C (32 to 122°F) with $\beta=2\%/^{\circ}\text{C}$ typical	-
	Battery Type / Life	1.5V (4) / approximately 250 hours of continuous use	1.5V (4) / approximately 120 hours of continuous use
	Environment	0 to 50°C (32 to 122°F); RH max 95% non condensing	
	Dimensions	175 x 41 x 23 mm (6.9 x 1.6 x 0.9")	
	Weight	95 g (3.4 oz.)	
Ordering Information	<b>HI98308</b> (PWT) and <b>HI98309</b> (UPW) are supplied with protective cap, calibration screwdriver (HI98308 only), batteries, and instructions.		



HI151

## Checktemp®4 Temperature Testers

*with folding probe and five-point factory calibration*

HI151 Checktemp 4 is the perfect portable, high-accuracy thermometer for home and professional kitchens. The sharp, stainless steel, fold-out probe is ideal when testing fresh, cooked and semi-frozen food. The sensing tip allows the user to accurately measure the temperature of thin or thick foods. HI151 Checktemp 4 measures temperature in both °C and in °F. EN 13485 certified models are available

Checktemp 4 has a waterproof and compact casing and is factory calibrated. Calibration is verified every time the thermometer is turned ON. A motion sensor eliminates the need of closing and reopening the probe when the meter goes idle.

Six color-coded thermometers are available to meet the food hygiene and Hazard Analysis Critical Control Point (HACCP) regulations.

- Five-point factory calibration
- Ergonomic shape
- Measures in both °C and °F
- Floating case features IP67 protection
- Large LCD
- Turns on by motion sensor
- Internal calibration verification
- EN 13485 certified models available



Easy to access battery compartment



**HI151 / HI151-000**  
white, for dairy products



**HI151-1 / HI151-100**  
red, for raw meat



**HI151-2 / HI151-200**  
blue, for raw fish



**HI151-3 / HI151-300**  
yellow, for cooked meat



**HI151-4 / HI151-400**  
green, for salad and fruits



**HI151-5 / HI151-500**  
brown, for vegetables

## Specifications

## HI151

Temperature	Range	-50.0 to 300 °C / -58.0 to 572.0 °F
	Resolution	0.1 °C (-50.0 to 199.9 °C); 1.0 °C (200.0 to 300.0 °C) 0.1 °F (-58.0 to 199.9 °F); 1.0 °F (200.0 to 572.0 °F)
	Accuracy (@25°C/77°F)	± 0.4 °C (-50.0 to -30.0 °C); ± 0.2 °C (-30.0 to 170.0 °C) ± 0.4 °C (170.0 to 199.9 °C); ± 1.0 °C ± 1 digit (200.0 to 300.0 °C) ± 0.8 °F (-58.0 to -22.0 °F); ± 0.4 °F (-22.0 to 199.9 °F) ± 1.0 °F (200.0 to 392.0 °F); ± 2.0 °F ± 1 digit (392.0 to 572.0 °F)
	Calibration	factory calibrated
Additional Specifications	Probe	stainless steel probe with penetration tip; 103 x 3 mm (dia.) (4.06 x 0.12" dia.)
	Battery Type / Life	CR2032 Li-ion (2) / approx. 4000 hours of continuous use
	Auto-off	1 min, 2 min (default), 8 min, 60 min. or OFF
	Environment	-30.0 to 50.0°C (32.0 to 122.0°F)
	Case ingress protection rating	IP67, floating case
	Dimensions	165 x 45 x 24 mm (6.5 x 1.8 x 0.9")
	Weight	85 g (3.0 oz)

## Ordering Information

**HI151** (white/dairy products) is supplied with batteries, quality certificate, and instruction manual.  
**HI151-000** (white/dairy products, EN 13485 certified) is supplied with batteries, quality certificate, and instruction manual.  
**HI151-1** (red/raw meat) is supplied with batteries, quality certificate, and instruction manual.  
**HI151-100** (red/raw meat, EN 13485 certified) is supplied with batteries, quality certificate, and instruction manual.  
**HI151-2** (blue/raw fish) is supplied with batteries, quality certificate, and instruction manual.  
**HI151-200** (blue/raw fish, EN 13485 certified) is supplied with batteries, quality certificate, and instruction manual.  
**HI151-3** (yellow/cooked meat) is supplied with batteries, quality certificate, and instruction manual.  
**HI151-300** (yellow/cooked meat, EN 13485 certified) is supplied with batteries, quality certificate, and instruction manual.  
**HI151-4** (green/salad and fruits) is supplied with batteries, quality certificate, and instruction manual.  
**HI151-400** (green/salad and fruits, EN 13485 certified) is supplied with batteries, quality certificate, and instruction manual.  
**HI151-5** (brown/vegetables) is supplied with batteries, quality certificate, and instruction manual.  
**HI151-500** (brown/vegetables, EN 13485 certified) is supplied with batteries, quality certificate, and instruction manual.

HI98501 Checktemp®

# Digital Thermometer

with Stainless Steel Penetration Probe

- Large display
  - The large display features a wide temperature range and optimal viewing angle.
- User selectable °C or °F
- CAL Check™
  - Automatically verifies calibration at startup
- IP65 water resistant protection
- Use as a tool for control in HACCP analysis
- AISI 316 stainless steel penetration probe

Checktemp® Digital Thermometer is a great choice for easy operation with clear digits and better accuracy over a wide range.

Measure temperature without fear of breakage or condensation. This compact meter with a direct probe is ideal for taking quick temperature measurement in semi-solids and liquids.

The sharp-tip probe of the Checktemp® easily penetrates semi-solid products making routine temperature checks simple and quick for both incoming and outgoing goods. Checktemp is the ideal instrument for measuring temperature according to HACCP requirements.

Checktemp is provided with Hanna's unique CAL Check™ function for accurate measurements every time. The Checktemp® implements a CAL Check upon startup and reports the status as "-0-" or "Err".



Select between °C or °F measurement in one tester



## CAL Check™

Automatically verifies calibration at startup and alerts the user to the calibration status



## Easy battery change

Easily replace the battery with a twist-off cover

## Save battery life with auto-off feature

With the auto-off feature, select from 8 min., 60 min., or disable the feature

Specifications	°C	°F
Range	-50.0 to 150.0°C	-58.0 to 302°F
Resolution	0.1°C (-50.0 to 150.0°C)	0.1°F (-58.0 to 199.9°F); 1°F (above 200°F)
Accuracy	±0.2°C (-30 to 120°C) ±0.3°C (outside: -50.0 to -30.0°C and 120.0 to 150.0°C)	±0.5°F (-22 to 199.9°F) ±1°F (outside: -58.0 to -22.0°F and 200 to 302°F)
Probe	fixed, stainless steel probe; 106 x ø 3.6 mm (penetration)	
Battery Type / Life	CR2032 Li-ion / approximately 2000 hours of continuous use	
Auto Off	8 min (default), 60 min or OFF	
Environment	-30 to 50°C (-22 to 122°F); IP65	
Dimensions	50 x 185 x 21 mm (2 x 7.3 x 0.9")	
Weight	50 g (1.8 oz.)	
Ordering Information	<b>HI98501</b> (Checktemp®) is supplied with penetration probe, protective cap, battery, and instructions.	



HI98509 Checktemp®1

## Digital Thermometer

with Stainless Steel Probe Attached to a 1 m (3.3') Silicone Cable

- EN13485 certified
- Battery life up to two years
  - With the Auto-Off feature, select from 8 min., 60 min., or disable the feature
- HACCP
  - Use as a tool for control in HACCP analysis
- Large display
  - The large display features a wide temperature range and viewing angle
- IP65 water resistant protection
- Silicone probe cable
  - 1 m (3.3') silicone cable maintains flexibility and performance in applications where temperatures are widely variable
- AISI 316 stainless steel penetration probe

Checktemp 1 is a high-accuracy thermometer with a 1 m (3.3') flexible, silicone cable connecting the meter and the AISI 316 stainless steel probe. This probe is in compliance with food regulations, making it an ideal instrument for measuring temperature according to HACCP requirements. The sharp-tip penetration probe easily lances semi-solid products such as fruits, vegetables, and cheeses. This probe can also handle measurements in liquid, air, and frozen materials. The probe incorporates an NTC thermistor sensor to measure the temperature. Thermistors make it possible to obtain extremely high accuracy in a very short period of time.

The Hanna CAL Check feature has been incorporated into the Checktemp 1 for reliable and accurate measurements. CAL Check automatically runs a self-check diagnostic upon startup and reports status back to the user.



### CAL Check™

Automatically verifies calibration at startup and alerts the user to the calibration status.

Specifications	HI98509
Range	-50.0 to 150.0°C / -58.0 to 302°F
Resolution	0.1°C (-50.0 to 150°C) / 0.1°F (-58.0 to 199.9°F); 1°F (above 200°F)
Accuracy	±0.2°C (-30 to 120.0°C); ±0.3°C (outside: -50.0 to -30.0°C and 120.0 to 150.0°C) ±0.5°F (-22.0 to 199.9°F); ±1°F (outside: -58.0 to -22.0°F and 200 to 302°F)
Probe	stainless steel probe with 1 m (3.3') silicone cable; 97.3 x dia 3.5 mm (3.8 x dia 0.14")
Battery Type / Life	3 x 1.5V AAA / approximately 2 years of use
Auto Off	8 min (default), 60 min or OFF
Environment	-30 to 50°C (-4 to 122°F); IP65
Dimensions	107 x 59 x 17 mm (4.2 x 5.3 x .65")
Weight	130 g (4.6 oz.)
<b>Ordering Information</b>	<b>HI98509</b> (Checktemp 1) is supplied with penetration probe, batteries, stand, and instructions.



Select between °C or °F  
measurement in one tester

HI98539 Checktemp®Dip · HI985394

## Digital Thermometer

with Weighted Stainless Steel Probe Attached to a 3 m (9.9') Silicone Cable

- **Battery life up to two years**
  - With the Auto-Off feature, select from 8 min., 60 min., or disable the feature
- **HACCP**
  - Use as a tool for control in HACCP analysis
- **Large display**
  - The large display features a wide temperature range and viewing angle
- **IP65 water resistant protection**
- **Silicone probe cable**
  - 3 m (9.9') silicone cable maintains flexibility and performance in applications where temperatures are widely variable
- **AISI 316 stainless steel weighted probe**

HI98539 Checktemp Dip and the Pool Line HI985394 are high-accuracy thermometers with a 3 m (9.9') flexible, silicone cable connecting attached to a AISI 316 stainless steel weighted probe.

The probe incorporates an NTC thermistor sensor for temperature measurement. Thermistors make it possible to obtain extremely high accuracy in a very short period of time.

This probe is in compliance with food regulations, making the HI98539 an ideal instrument for measuring temperature in food applications such as wine casks and milk tanks.

In addition to pool and spa use, HI985394 can also be used for applications such as fish farms and water reservoirs where the operator can simply stand on the edge of the water and dip the probe in.

The Hanna CAL Check feature has been incorporated into these thermometers for reliable and accurate measurements. CAL Check automatically runs a self-check diagnostic upon startup and reports status back to the user.



### CAL Check™

Automatically verifies calibration at startup and alerts the user of the calibration status.



Select between °C or °F measurement in one tester

Specifications	HI98539 • HI985394 (Pool Line)
Range	-20.0 to 80.0°C / -4.0 to 176.0°F
Resolution	0.1°C / 0.1°F
Accuracy	±0.3°C / ±0.5°F
Probe	weighted stainless steel probe with 3 m (9.9') silicone cable
Battery Type / Life	3 x 1.5V AAA / approximately 2 years of use
Auto Off	8 min (default), 60 min or OFF
Environment	-30 to 50°C (-22 to 122°F); IP65
Dimensions	107 x 59 x 17 mm (4.2 x 2.3 x 0.7")
Weight	109 g (3.8 oz.)
<b>Ordering Information</b>	<b>HI98539</b> (Checktemp®Dip) and <b>HI985394</b> is supplied with stainless steel weighted probe, stand, batteries, and instructions.



HI145

## T-Shaped Thermometer

- **CAL Check™**
  - Alerts users to calibration status
- **HOLD Feature**
  - HOLD button to freeze readings on the display



HI145 thermometers were developed for HACCP programs that require high standards of performance with simplicity of use. The durable T-shaped handle fits comfortably in your hand and is ideal for applications where applied force is necessary for insertion, such as with incoming meat inspection and semi-frozen foods. The LCD positioned on top of the meter allows for easy reading in cooking applications.

The HI145-00 and HI145-01 thermometers are equipped with a 125 mm (5") long AISI 316 stainless steel probe. The sharp conical tip provides fast response and improved accuracy over the entire range.

The HI145-20 and HI145-30 thermometers are supplied with a 300 mm (12") long stainless steel probe, ideal for monitoring hot liquids, such as in deep frying and soup preparation.

With an automatic CAL Check feature, the HI145 series performs a self-check of its calibration status and displays it on the LCD. This feature ensures accuracy, repeatability, and confidence in readings.



Specifications	HI145-00	HI145-01	HI145-20	HI145-30
Range	-50.0 to 220°C	-58.0 to 428.0°F	-50.0 to 220°C	-58.0 to 428.0°F
Resolution	0.1°C (-50.0 to 199.9°C); 1°C (200 to 220°C)	0.1°F (-58.0 to 199.9°F); 1°F (200 to 428°F)	0.1°C (-50.0 to 199.9°C); 1°C (200 to 220°C)	0.1°F (-58.0 to 199.9°F); 1°F (200 to 428°F)
Accuracy	±0.3°C (-20 to 90°C); ±0.4% F.S. (outside)	±0.6°F (-4 to 194°F); ±0.4% F.S. (outside)	±0.3°C (-20 to 90°C) ±0.4% F.S. (outside)	±0.6°F (-4 to 194°F); ±0.4% F.S. (outside)
Probe	stainless steel probe; 125 mm x dia 5 mm (4.9 x dia 0.2")		stainless steel probe; 300 mm x dia 5 mm (11.8 x dia 0.2")	
Battery Type / Life	1.5V AAA / approximately 10,000 hours of continuous use; auto-off after 8 minutes of non-use			
Environment	-10 to 50°C (14 to 122°F); RH max 95%		-10 to 50°C (14 to 122°F); RH max 95%	
Dimensions	92 x 165 x 38 mm (3.6 x 6.5 x 1.5")		92 x 340 x 38 mm (3.6 x 13.4 x 1.5")	
Weight	65 g (2.3 oz.)		80 g (2.8 oz.)	
Ordering Information	All models of the HI145 series are supplied complete with battery and instructions. HI145-00 with 125 mm probe, HI145-01 with 125 mm probe, HI145-20 with 300 mm probe; HI145-30 with 300 mm probe			

# GroLine®

HI981421

## GroLine® Hydroponics Monitor

with inline multiparameter probe

Testers and Monitors

monitors



## 24/7 Monitoring

The HI981421 GroLine Monitor provides 24 hour continuous monitoring of pH, conductivity (EC or TDS), and temperature in hydroponic nutrients. Quick to setup and simple to use, this monitor was designed with hydroponics, aquaponics, and greenhouses in mind. Make your nutrient solution easy to manage with the GroLine Monitor and combined pH/EC/Temperature probe.

## Instantly See All Measurements

The versatile display of the GroLine Monitor allows for three screen modes. The LCD can display all three essential hydroponic nutrients measurements at one time, a 3-second cycle of single measurements, or a real-time graph screen with options for measurement selection and log recall.

## Features

- Can be integrated into a fertilizer system
- pH/EC inline probe with built-in temperature sensor
- IP65 rated enclosure designed to withstand harsh growing environments
- Selectable EC to TDS conversion factor: choice of either a 0.5 or 0.7 conversion factor
- Automatic Temperature Compensation
  - All readings are compensated for variations in temperature. Temperature displayed in °C or °F along with pH, EC, or TDS reading
- Large LCD with plant-friendly green backlighting
- Ambient light sensor for automatic LCD dimming
- Quick calibration using Quick Cal solution simultaneously for pH and EC
- Calibration reminder
- Data logging for 30 days
  - Logs every 15 minutes for last 30 days, stores min, max, and average values
- Setup, Calibration, and Operating parameters are stored in nonvolatile memory. All settings are retained if power is lost
- 24 hour summary screens (plot and details)
- GLP feature calibration data for the pH and EC (up to 5 calibrations)
- Alarms feature for all parameters

## Monitor Changes Over Time

Fluctuations in your hydroponic nutrient solution can have lasting effects on your plants. The GroLine Monitor automatically logs every 15 minutes for the last 30 days, and stores min, max, and average values so you can recognize when patterns arise and help prevent future problems. For review and storage, use the USB-C to easily transfer data to a flash drive or PC using a cable. Files are exported as .csv.

## Grow With Confidence

The GroLine Monitor frees up your time by doing the testing for you. Simply set high and low alarm levels - if your hydroponic nutrient solution moves out of range a measurement error will display. A quick look at the large display will let you know if your nutrient solution needs adjusting.



## Quick Cal

Quick Cal is for use with Hanna's GroLine pH and/or EC/TDS meters. Using the Quick Cal function found in compatible meters allows for single-point calibration for pH and/or conductivity sensors.



## Inline Probe

The supplied HI1285-9 multiparameter probe measures pH, EC, and temperature in one convenient, rugged probe. A solid-state preamplifier is integrated into the probe to protect the pH measurement from transient electrical noise. Sources of electrical noise include ballasts used in lighting and pumps to circulate water and nutrient solutions. The HI1285-9 incorporates two graphite EC sensors for reliable conductivity readings



## On-Screen Features

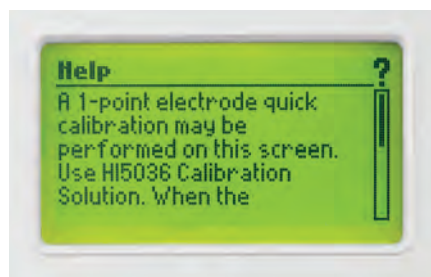

### On-screen Help

Contextual help is available at the push of a button.



### High and Low Alarms

High and Low alarms for pH, EC/TDS, and Temperature. Warns when process is out of desired range by flashing display and message

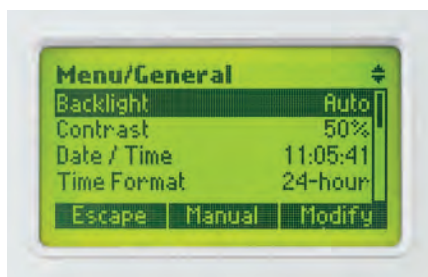
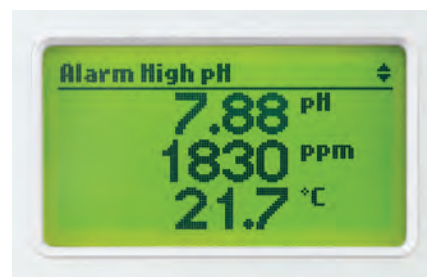

### Menu Navigation

Easy to navigate menu system to access calibration, GLP, and meter setup

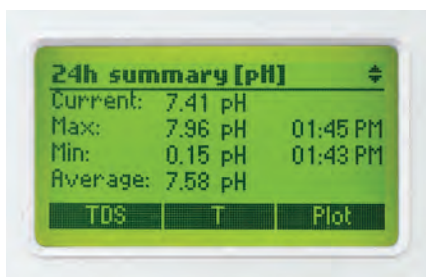

### Data Viewing

30 day and 24 hour summary screens can be viewed in plot or detail views. Real-time data can be viewed in plot view

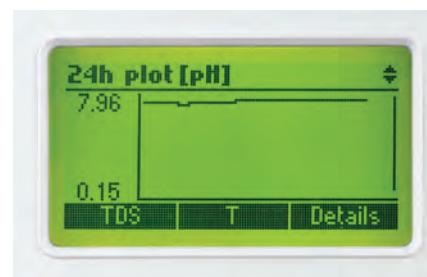

### Data Transfer

Data transfer: USB-C port for easy data transfer to memory stick or PC



### Calibration Timeout

Set a reminder to calibrate your probe. Reminder can be set from 1 to 30 days



### GLP

The HI981421 can store calibration info from the last 5 pH and EC calibrations

## Supplied Complete

HI981421 GroLine Monitor is supplied with all the tools necessary so you can start monitoring right away.



Specifications	HI981421	
pH	Range	0.00 to 12.00 pH, 0.0 to 12.0 pH
	Resolution	0.01 pH; 0.1 pH
	Accuracy	±0.05 pH, ±0.1pH
	Calibration	one or two-point calibration (using pH 4.01, 7.01, 10.01 buffers) using auto buffer recognition; one-point calibration using quick calibration solution
	Temperature Compensation	Automatic: 0.0 to 60.0°C; 32.0 to 140.0°F
EC	Range	0.00 to 10.00 mS/cm
	Resolution	0.01 mS/cm
	Accuracy	±0.1 mS/cm from 0.00 to 5.00 mS/cm; ±0.2 mS/cm from 5.00 to 10.00 mS/cm)
	Calibration	one-point at 1.41 mS/cm or 5.00 mS/cm using auto standard recognition; one-point calibration using quick calibration solution
	Temperature Compensation	automatic, with $\beta = 1.9\%/^{\circ}\text{C}$
TDS	Range	0 to 5000 ppm (0.5 TDS Factor*); 0 to 7000 ppm (0.7 TDS Factor*)
	Resolution	10 ppm (mg/L)
	Accuracy	±2%FS
	Calibration	through EC calibration
	Conversion Factor (CF)*	0.5 (500 ppm) or 0.7 (700 ppm)
Temperature	Range	0.0 to 60.0°C/32.0 to 140.0°F
	Resolution	0.1°C/0.1°F
	Accuracy	±0.5°C/±1°F
Probe	Description	HI1285-9 triple junction inline pH/EC/TDS temperature PVC body, pre-amplified multiparameter probe with internal temperature sensor, DIN connector, 3 m (9.8') cable
	Max Pressure	8 bar
	Range	0 to 12 pH
	Ingress protection	IP68 (continuous immersion up to 2 meters)
	Dimensions	187 x 25 x 25mm (7.36 x 0.98 x 0.98")
	Weight	191g (7.7oz.)
Additional Specifications	Automatic Logging	measurements (pH, EC, TDS, Temperature) min/max/average/status logged continuously at 15 minutes interval, recall graphic modes
	Data Export	export on USB-C flash drive or PC; log files in CSV format
	Data Storage	30 days stored data at 15 minutes interval
	Display	128 x 64 pixel B/W LCD with green backlight, Automatic backlight dimming using ambient light sensor.
	GLP	Good Laboratory Practice with last 5 pH and EC calibration history.
	Monitor Waterproof Protection	IP65 (dust and low pressure water jets)
	Alarms	high and low with enable/disable option for all parameters.
	USB-C (Host/Device)	Export logged data on USB flash drive / PC
	Power Supply	12VDC adapter (included)
	Environment	0 to 50°C (32 to 122°F), RH max 95% non-condensing
	Dimensions	125 x 185 x 38 mm (4.92 x 7.28 x 1.49")
Weight	333g (11.7oz.)	
Ordering Information	<b>HI981421-01</b> (115V) and <b>HI981421-02</b> (230V) is supplied with HI1285-9 multiparameter probe, Quick Cal buffer solution sachets (2), HI700661 electrode cleaning solution sachets for agriculture (2), 12VDC power adapter, quality certificates and instruction manual.	

\*Note: 1000 µS/cm = 500 ppm with 0.5 TDS Factor  
= 700 ppm with 0.7 TDS Factor

pH solutions begin on page 2.174; Quick Cal solutions begin on page 2.181;  
EC and TDS solutions begin on page 5.36; see pH electrode specifications on page 1.70



## 24/7 Monitoring

The HI981420 GroLine Monitor provides 24 hour continuous monitoring of pH, conductivity (EC or TDS), and temperature in hydroponic nutrients. Quick to setup and simple to use, this monitor was designed with hydroponics, aquaponics, and greenhouses in mind. Make your nutrient solution easy to manage with the GroLine Monitor and combined pH/EC/Temperature probe.

## Instantly See All Measurements

The versatile display of the GroLine Monitor allows for three screen modes. The LCD can display all three essential hydroponic nutrients measurements at one time, a 3-second cycle of single measurements, or a real-time graph screen with options for measurement selection and log recall.

## Features

- 3 sensors combined in a single rugged probe body
  - pH electrode, amperometric EC/TDS sensor, and an internal temperature sensor for temperature compensated readings
- IP65 rated enclosure designed to withstand harsh growing environments
- Selectable EC to TDS conversion factor: choice of either a 0.5 or 0.7 conversion factor
- Automatic Temperature Compensation
  - All readings are compensated for variations in temperature. Temperature displayed in °C or °F along with pH, EC or TDS reading
- Large LCD with plant-friendly green backlighting
- Ambient light sensor for automatic LCD dimming
- Calibration reminder
- Data logging for 30 days
  - Logs every 15 minutes for last 30 days, stores min, max, and average values

## Monitor Changes Over Time

Fluctuations in your hydroponic nutrient solution can have lasting effects on your plants. The GroLine Monitor automatically logs every 15 minutes for the last 30 days, and stores min, max, and average values so you can recognize when patterns arise and help prevent future problems. For review and storage, use the USB-C to easily transfer data to a flash drive or PC using a cable. Files are exported as .csv.

## Grow With Confidence

The GroLine Monitor frees up your time by doing the testing for you. Simply set high and low alarm levels - if your hydroponic nutrient solution moves out of range a measurement error will display. A quick look at the large display will let you know if your nutrient solution needs adjusting.



## Quick Cal

Quick Cal is for use with Hanna's GroLine pH and/or EC/TDS meters. Using the Quick Cal function found in compatible meters allows for single-point calibration for pH and/or conductivity sensors.





### Simpler with a combination probe

The HI1285-8 is a 3-in-1 pre-amplified combination probe. This probe is built to be durable and features two graphite sensors for reliable conductivity readings. A built-in temperature sensor ensures fast, accurately compensated readings even during sudden temperature fluctuations.

## On-Screen Features

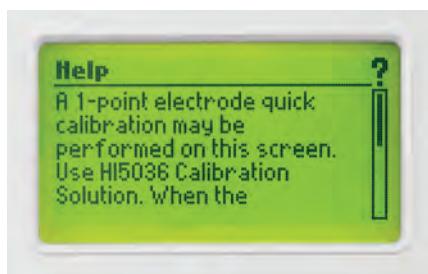

### On-screen Help

Context sensitive help is available at the push of a button



### High and Low Alarms

High and Low alarms for pH, EC/TDS, and Temperature. Warns when process is out of desired range by flashing display and message

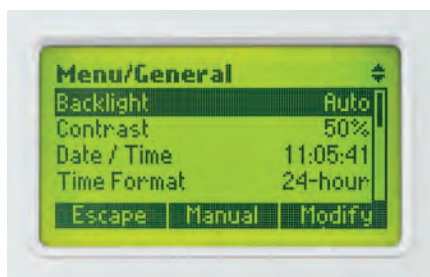
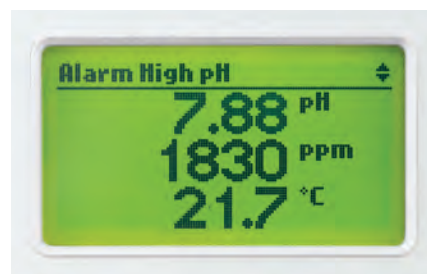

### Menu Navigation

Easy to navigate menu system to access calibration, GLP, and meter setup

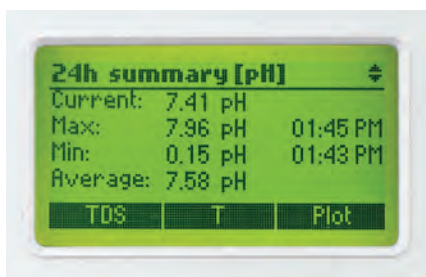

### Data Viewing

30 day and 24 hour summary screens can be viewed in plot or detail views. Real-time data can be viewed in plot view

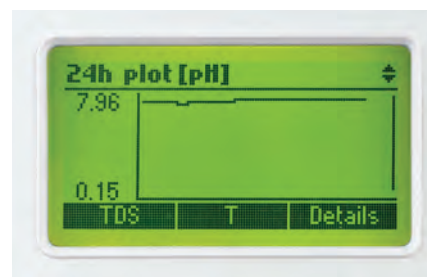

### Data Transfer

Data transfer: USB-C port for easy data transfer to memory stick or PC



### Calibration Timeout

Set a reminder to calibrate your probe. Reminder can be set from 1 to 30 days



### GLP

The HI981420 can store calibration info from the last 5 pH and EC calibrations



## Supplied Complete

HI981420 GroLine Monitor is supplied with all the tools necessary so you can start monitoring right away.



Specifications	HI981420	
pH	Range	0.00 to 14.00 pH; 0.0 to 14.0 pH
	Resolution	0.01 pH; 0.1 pH
	Accuracy	±0.05 pH, ±0.1pH
	Calibration	one or two-point calibration (using pH 4.01, 7.01, 10.01 buffers) using auto buffer recognition; one-point calibration using quick calibration solution
	Temperature Compensation	automatic from 0.0 to 60.0°C (32.0 to 140.0°F)
EC	Range	0.00 to 10.00 mS/cm
	Resolution	0.01 mS/cm
	Accuracy	±0.1 mS/cm from 0.00 to 5.00 mS/cm; ±0.2 mS/cm from 5.00 to 10.00 mS/cm)
	Calibration	one-point at 1.41 mS/cm or 5.00 mS/cm using auto standard recognition; one-point calibration using quick calibration solution
	Temperature Compensation	automatic, with $\beta = 1.9\%/^{\circ}\text{C}$
TDS	Range	0 to 5000 ppm (0.5 TDS Factor)*; 0 to 7000 ppm (0.7 TDS Factor)*
	Resolution	10 ppm (mg/L)
	Accuracy	±2%FS
	Calibration	through EC calibration
	Conversion Factor (CF)	0.5 (500 ppm) or 0.7 (700 ppm)
Temperature	Range	0.0 to 60.0°C/32.0 to 140.0°F
	Resolution	0.1°C/0.1°F
	Accuracy	±0.5°C/±1°F
Probe	Description	HI1285-8 pH/EC/TDS/temperature polypropylene body, pre-amplified multiparameter probe with internal temperature sensor DIN connector and 2 m (6.6') cable
	Max Pressure	0.2 bar
	Range	0 to 13 pH
	Ingress protection	IP68 (continuous immersion up to 2 meters)
	Dimensions	187 x 25 x 25mm (7.36 x 0.98 x 0.98")
	Weight	191g (7.7oz.)
Additional Specifications	Automatic Logging	measurements (pH, EC, TDS, Temperature) min/max/average/status logged continuously at 15 minutes interval, recall graphic modes
	Data Export	export on USB-C flash drive or PC; log files in CSV format
	Data Storage	30 days stored data at 15 minutes interval
	Display	128 x 64 pixel B/W LCD with green backlight, Automatic backlight dimming using ambient light sensor.
	GLP	Good Laboratory Practice with last 5 pH and EC calibration history.
	Monitor Ingress Protection	IP65 (dust and low pressure water jets)
	Alarms	high and low with enable/disable option for all parameters.
	USB-C (Host/Device)	Export logged data on USB flash drive / PC
	Power Supply	12VDC adapter (included)
	Environment	0 to 50°C (32 to 122°F), RH max 95% non-condensing
	Dimensions	125 x 185 x 38 mm (4.92 x 7.28 x 1.49")
Weight	333g (11.7oz.)	
Ordering Information	<b>HI981420-01</b> (115V) and <b>HI981420-02</b> (230V) is supplied with HI1285-8 multiparameter probe, Quick Cal buffer solution sachets (2), HI700661 electrode cleaning solution sachets for agriculture (2), power adapter, quality certificates, and instruction manual.	

\*Note: 1000  $\mu\text{S}/\text{cm}$  = 500 ppm with 0.5 TDS Factor  
= 700 ppm with 0.7 TDS Factor

pH solutions begin on page 2.174; Quick Cal solutions begin on page 2.181;  
EC and TDS solutions begin on page 5.36; see pH electrode specifications on page 1.70



HI981520

## Marine Monitor

*pH, Marine Salinity, and Temperature*

Testing and monitoring salinity in saltwater aquariums is an ongoing task.

The HI981520 is an easy to use vertical mount unit that continuously monitors and displays conductivity and pH.

The system can be calibrated at one or two points for pH and at one point for conductivity.

Seawater salinity is expressed in either parts per thousand (ppt), Practical Salinity Units (PSU), or Specific Gravity (S.G.).

A high/low alarm can be configured for each parameter and the results are displayed on a large, easy to read LCD.

The attached two-electrode conductivity probe features a built-in temperature sensor for rapid, high-accuracy temperature readings.

The Hanna HI1286 pH double junction, gel-filled pH electrode features a PEI resin body that is easy to clean and resistant to many aggressive chemicals. Additionally, the double junction design is less susceptible to clogging for fast and stable readings.

- Waterproof
- Automatic temperature compensation (ATC)
- Dual pin graphite EC probe

## Features



### Backlit LCD

Easy to read backlit LCD display with the option to change LCD color from the setup menu

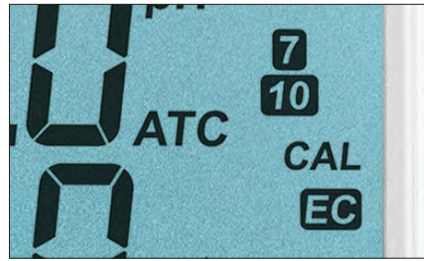

### Automatic Calibration

A one or two-point pH calibration can be performed using one of the two standard buffer solutions: 7.01 or 10.01pH. A one-point conductivity calibration can be performed using 35.00 ppt salinity standard solution.

CAL Tags display in measurement mode after a calibration has been performed.



### Automatic Temperature Compensation

All readings are compensated for variations in temperature and can be displayed with temperature values in °C or °F. Choose °C or °F measurement through the setup menu.

## High/Low Alarms



### Alarm Setup

High/Low alarms can be set for each supported parameter (or can be disabled) quickly through the setup menu.

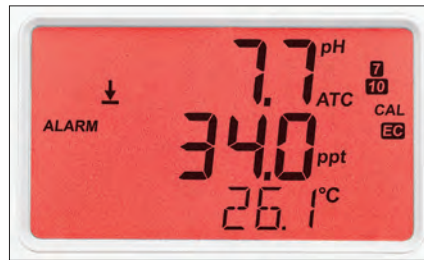

### Alarm State

Alarms are generated when measured value exceeds or drops below configured parameter High/Low Value.



### Optional Acoustic Alarm

An acoustic signal can be generated each time an alarm is triggered and can be silenced at the touch of a button. Enable or disable this feature easily through the setup menu.

## Seawater Salinity



### ppt

Measurements expressed in ppt are based on the Natural Seawater Scale that extends from 0.00 to 80.00 g/L and covers 10 to 31 °C temperature range. It determines the salinity based upon a conductivity ratio of sample to standard seawater at 15 °C and an approximate salinity value of 35 in seawater.



### PSU

The practical salinity of seawater relates the ratio of electrical conductivity of a normal seawater sample at 15 °C and 1 atmosphere to a potassium chloride solution (KCl) with a mass of 32.4356 g/Kg water at the same temperature and pressure. Under these conditions the ratio is equal to 1 and S=35. The practical salinity scale may be applied to values 0 through 42.00 psu at temperatures between 0 to 35 °C.



### Specific Gravity (S.G.)

Specific Gravity, or relative density, is expressed as the ratio of the density of seawater, at a specific temperature, relative to the density of the same volume of pure water at a specific temperature.

The probes are secured with suction cups to the back of an aquarium (tank) and are suited for continuous measurement of conductivity and associated parameters required in applications such as seawater, saltwater aquariums, or aquaculture.



### 1. Method and Parameter

Chosen parameter and method used is displayed along with the reading.

### 2. Dedicated Setup Key

A dedicated setup key allows users to quickly navigate to setup options.

### 3. Dedicated Calibration Key

A dedicated calibration key allows users to start a one or two-point pH and EC automatic calibration at the touch of a button.

### 4. Splash-proof Keypad

Intuitive on-screen menus are easy to navigate with the splash-proof keypad

### 5. Power Supply

The 12 Vdc adapter (included) allows for continuous monitoring

### 6. Compact size

Measures 125 mm (4.92") x 185 mm (7.28") and only 38 mm (1.49") thick.

### 7. Replaceable pH probe with BNC connection

The PEI resin body is easy to clean and resistant to many aggressive chemicals.

The porous PTFE junction is equally resistant to aggressive chemicals.

The double junction design presents a silver-free electrolyte solution interacting with the sample, making the electrode less susceptible to clogging and guaranteeing a fast response and stable reading.

### 8. Fixed EC probe

Built-in temperature sensor at the tip of the EC sensor allows for rapid determination of the sample temperature and a high-accuracy temperature reading.

## Installation

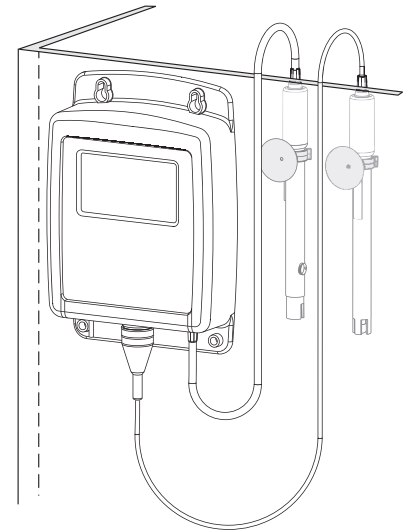

### Supplied Option

The probes can be installed/immersed directly in a tank or aquarium (with supplied suction cups) and are suited for continuous measurement of conductivity and associated parameters required in applications such as seawater, saltwater aquariums, or aquaculture. Each probe features a 2 m (6.6') cable length for extended distances between monitor and sample.

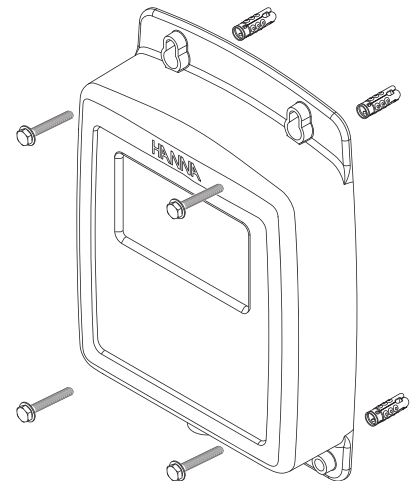

### User Supplied Option

Alternatively, the monitor can be secured using the screw mount option (user supplied hardware).

Specifications	HI981520	
pH	Range*	0.0 to 14.0 pH
	Resolution	0.1 pH
	Accuracy	±0.2 pH
	Calibration	manual or automatic two-point calibration in 7.01 and 10.01 pH
ppt	Range	0.0 to 70.0 ppt (g/L)
	Resolution	0.1 ppt (g/L)
	Accuracy	±1.0 ppt between 0.0 ppt and 40.0 ppt ±2.0 ppt between 40.0 ppt and 70.0 ppt
	Calibration	automatic, single point in 35.00 ppt
PSU	Range	0.0 to 70.0 PSU
	Resolution	0.1 PSU
	Accuracy	±1.0 PSU between 0.0 and 40.0 PSU ±2.0 PSU between 40.0 and 70.0 PSU
S.G.	Range	1.000 to 1.041 S.G.
	Resolution	0.001 S.G.
	Accuracy	±0.001 S.G.
Temperature	Range	0.0 to 50.0 °C (32.0 to 122.0 °F)
	Resolution	0.1 °C / 0.1 °F
	Accuracy	±0.5 °C / ±1.0 °F
	Compensation	Automatic, 5 to 50 °C (41 to 122 °F)
Alarm	pH	High or Low with Enable or Disable option
	EC	High or Low with Enable or Disable option
	Temperature	High or Low with Enable or Disable option
High/Low Value	with High/Low alarm Enabled	
Probes	pH	HI1286 double junction pH electrode with 2 m (6.6') cable
	EC	attached
Power Supply	12 Vdc adapter (included) from 115 Vac, and 230 Vac	
Environment	0 to 50 °C (32 to 122 °F); RH max 95%, non-condensing	
Casing	IP65 ingress protection	
Dimensions	125 x 185 x 38 mm (4.92 x 7.28 x 1.49")	
Weight	300 g (10.6 oz)	

**Ordering Information**

**HI981520-01** (115 VAC) and **HI981520-02** (230 VAC) Marine Monitor is supplied with HI1286 pH electrode; attached EC and temperature probe; pH 7.01 buffer solution, 20 mL sachet (2 pcs.); pH 10.01 buffer solution, 20 mL sachet (2 pcs.); 35.00 ppt salinity calibration solution, 20 mL sachet (2 pcs.); electrode cleaning solution, 20 mL sachet (2 pcs.); suction cup with clip (2 pcs.); self-adhesive fastener (2 pcs.); 12 Vdc power adapter; quick reference guide with QR code for manual download and instrument quality certificate.

Solutions and Accessories	
	<b>HI1286</b> Double junction pH electrode with 2 m (6.6') cable
	<b>HI70007P</b> pH 7.01 solution, 20 mL sachet (25 pcs.)
	<b>HI7007M</b> pH 7.01 solution, 230 mL bottle
	<b>HI70010P</b> pH 10.01 solution, 20 mL sachet (25 pcs.)
	<b>HI7010M</b> pH 10.01 solution, 230 mL bottle
	<b>HI70024M</b> 35.00 ppt salinity calibration solution, 230 mL bottle
	<b>HI70024P</b> 35.00 ppt salinity calibration solution, 20 mL sachet (25 pcs.)
	<b>HI70300M</b> Storage solution for pH electrodes, 230 mL bottle
	<b>HI700601P</b> General purpose cleaning solution, 20 mL sachet (25 pcs.)
	<b>HI7061M</b> Cleaning solution for pH electrodes, 230 mL bottle

\* The range may be limited by the probe's limits.



#### Specifications HI1286 pH Probe

Range	0 to 13 pH
Recommended operating temperature	0 to 80 °C (32 to 176 °F)
Body	PEI
Junction	PTFE
Reference	Double junction, Ag/AgCl
Electrolyte	Polymer
Tip	Spheric / Ø 7.5 mm (0.29")
Diameter	12 mm (0.47")
Body length	160 mm (6.29")
Maximum pressure	3 bar (44 psi)
Cable type/length	Coaxial / 2 m (6.56')
Connection	BNC



#### Specifications EC and Temperature Probe

Range	0.0 to 70.0 ppt 0.0 to 70.0 PSU 1.000 to 1.041 S.G.
Recommended operating temperature	0 to 50 °C (32 to 122 °F)
Body	Polypropylene (PP)
Conductivity sensor	Material: ABS Electrode: Graphite
Temperature sensor	AISI 316 stainless steel
Outer Diameter	12.50 mm
Overall length	155 mm (6.10")
Maximum pressure	3 bar (44 psi)
Cable type/length	Coaxial / 2 m (6.56')
Connection	Fixed (to the monitor)

HI146-00

## Wall-Mounted Precision Thermometer

- **CAL Check™**
  - Alerts users of calibration status
- **HACCP**
  - Meets HACCP requirements
- **Water resistant**

The HI146-00 is a high accuracy thermometer with a professional grade probe attached to a flexible 2 m (6.6') cable. The CAL Check feature is incorporated into its function to allow you to confirm the accuracy of the meters any time.

You can monitor the exact temperature of any product continuously and easily observe it on the LCD display.

With its compact and simplified design, featuring a fixed stainless steel probe and optional probe holder, this thermometer is ideal for monitoring the temperatures of liquids, semi-solids, and refrigerated foods.

The HI146-00 can be easily carried from station to station or installed in a fixed position using the molded eye and a wall mount probe holder.

In order to make sure that the meter is reporting the correct temperature, the HI146-00 has been designed with Hanna's exclusive CAL Check switch. By simply setting the switch from "READ" to "TEST" and without requiring any external equipment, users can ensure the accuracy of the meter. In the "TEST" mode, the HI146-00 shows 0.0 °C (32.0°F) with an accuracy of  $\pm 0.3^{\circ}\text{C}$  ( $\pm 0.5^{\circ}\text{F}$ ). With this Hanna innovation, the accuracy can be checked throughout the life of the thermometer without requiring any accessories or additional investments.



Specifications	HI146-00 (Pronto)
Range	-50.0 to 150.0°C
Resolution	0.1°C
Accuracy	$\pm 0.3^{\circ}\text{C}$ (-20 to 90°C) $\pm 0.5^{\circ}\text{C}$ (outside)
Temperature Probe	stainless steel probe (fixed) with 2 m (6.6') cable; 160 x dia 3 mm (6.3 x dia 0.1")
Battery Type / life	1.5V AA / approximately 5 years
Environment	0 to 50°C (32 to 122°F); RH max 95%
Dimensions	86 x 110 x 43 mm (3.4 x 4.3 x 1.7")
Weight	150 g (5.3 oz.)
<b>Ordering Information</b>	<b>HI146-00</b> (Pronto) is supplied with stainless steel temperature probe, battery, and instructions.



HI147

## Checkfridge Remote Sensor Thermometer

- CAL Check™
  - Alerts users of calibration status
- Battery Error Prevention System (BEPS)
  - Alerts the user of low battery power that could adversely affect readings

Few manufacturers have given any thought to providing the user a convenient means to monitor internal temperature conditions of a refrigerator or freezer from the outside.

Water testing laboratories require constant monitoring of refrigerators and incubators for compliance to standard operations. The Hanna HI147 Checkfridge is the ideal thermometer for accurate, reliable internal temperature readings.

How do you know when the reading on the thermometer is correct? An ice point slurry using distilled or deionized water can be made. Even then there could be several degrees difference between the real and theoretical temperatures. With the HI147, there is no need to waste time preparing an ice bath for making these tests; its unique CAL Check feature can simulate it.



Specifications	HI147-00 Checkfridge C	HI147-01 Checkfridge F
Range	-50.0 to 150.0°C	-58.0 to 302.0°F
Resolution	0.1°C	0.1°F (-58.0 to 199.9°F) 1°F (200 to 302°F)
Accuracy	±0.3°C ±1 digit (-20.0 to 90.0 °C); ±0.5% f.s. ±1 digit (outside)	±0.5°F ±1 digit (-4.0 to 194.0 °F); ±1% f.s. ±1 digit (outside)
CAL Check	manual, through switch	
Temperature Probe	stainless steel probe with 1 m (3.3') cable (fixed); 40 x dia 5 mm (1.6 x dia 0.2")	
Battery Type / Life	1.5V AA / approximately 30,000 hours of continuous use	
Environment	0 to 50°C (32 to 122°F); RH max 95%	
Dimensions (meter only)	93 x 39 x 31 mm (3.7 x 1.5 x 1.2")	
Weight	60 g (2.1 oz.)	
Ordering Information	<b>HI147-00</b> (Checkfridge C) is supplied with battery and instructions. <b>HI147-01</b> (Checkfridge F) is supplied with battery and instructions.	



CODE	HI73127	HI73120	HI73311	HI1270
Description	pH electrode	ORP electrode	EC/TDS electrode	pH electrode
Reference	single, Ag/AgCl	single, Ag/AgCl	-	single, Ag/AgCl
Junction / Flow Rate	cloth	cloth	-	open
Electrolyte	gel	gel	-	viscolene
Max Pressure	0.1 bar	0.1 bar	-	0.1 bar
Range	pH: 0 to 14	ORP: $\pm 2000$ mV	-	pH: 0 to 13
Recommended Operating Temp.	-5 to 50°C (23 to 122°F)	-5 to 50°C (23 to 122°F)	-5 to 50°C (23 to 122°F)	0 to 50°C (32 to 122°F)
Glass Type	LT (low temperature)	-	-	GP (general purpose)
Tip /Shape	spheric (dia: 5.0 mm)	platinum pin	-	spheric (dia: 3.0 mm)
Temperature Sensor	no	no	no	no
Amplifier	no	no	no	no
Body Material	polypropylene	polypropylene	polypropylene	polypropylene
Cable	no	no	no	no
Recommended Use	general purpose, field applications	general purpose, field applications	general purpose, field applications	general purpose, field applications
Connection	pin	pin	pin	screw cap





CODE	HI1271	HI1280	HI1290	HI1295
Description	pH electrode	pH electrode	pH electrode	pH electrode
Reference	single, Ag/AgCl	single, Ag/AgCl	single, Ag/AgCl	single, Ag/AgCl
Junction / Flow Rate	open	ceramic, single / 15-20 µL/H	ceramic, single / 15-20 µL/H	ceramic, single / 15-20 µL/H
Electrolyte	viscolene	gel	gel	gel
Max Pressure	0.1 bar	0.1 bar	0.1 bar	2 bar
Range	pH: 0 to 13	pH: 0 to 13	pH: 0 to 13	pH: 0 to 13
Recommended Operating Temp.	0 to 50°C (32 to 122°F)	0 to 70°C (32 to 158°F)	0 to 70°C (32 to 158°F)	0 to 70°C (32 to 158°F)
Glass Type	GP (general purpose)	GP (general purpose)	GP (general purpose)	GP (general purpose)
Tip /Shape	spheric (dia: 3.0 mm)	spheric (dia: 5.0 mm)	spheric (dia: 5.0 mm)	spheric (dia: 5.0 mm)
Temperature Sensor	no	yes	yes	yes
Amplifier	no	yes	yes	yes
Body Material	polypropylene	polypropylene	polypropylene	polypropylene
Cable	no	no	no	no
Recommended Use	general purpose, field applications	general purpose, field applications	general purpose, field applications	general purpose, field applications
Connection	screw cap	multi-pin	multi-pin	multi-pin



CODE	HI1285-8	HI1285-9	HI1286	HI1293
Description	pre-amplified pH and EC probe	pre-amplified pH and EC inline probe	pH electrode	pH electrode
Reference	single, Ag/AgCl	triple, Ag/AgCl	double, Ag/AgCl	double, Ag/AgCl
Junction / Flow Rate	cloth	PTFE	PTFE	PTFE
Electrolyte	gel	polymer	polymer	polymer
Max Pressure	.2 bar	8 bar	3 bar	3 bar
Range	pH: 0 to 13 / EC	pH: 0 to 12 / EC	pH: 0 to 13	pH: 0 to 13
Recommended Operating Temp.	0 to 50°C (32 to 122°F)	0 to 60°C (32 to 140°F)	0 to 80°C (32 to 176°F)	0 to 60°C (32 to 140°F)
-	LT (low temperature)	LT (low temperature)	GP (general purpose)	GP (general purpose)
Tip / Shape	spheric (dia: 8.5 mm)	dome	spheric (dia: 7.5 mm)	spheric (dia: 7.5 mm)
Temperature Sensor	yes	yes	no	no
Amplifier	yes	yes	no	yes
Body Material	polypropylene	PVC (thread 3/4" NPT)	PEI	PEI
Cable	7-pole; 1 m cable (3.3')	7-pole; 3 m cable (9.9')	coaxial; 2 m (6.6')	5-pole; 2 m (6.6')
Recommended Use	hydroponics, aquaponics, greenhouses	hydroponics, aquaponics, greenhouses	general purpose, water treatment, agriculture	hydroponics, greenhouses
Connection	DIN*	DIN*	BNC	DIN

\* To be used with HI981420 GroLine monitor

\* To be used with HI981421 GroLine monitor



**Introduction..... 2.2**

Comparison Guides..... 2.4

**Benchtop ..... 2.8**

HI6000 Series..... 2.8

HI5000 Series..... 2.18

with Built-in Printer..... 2.24

**edge®**

edge..... 2.26

edge pH..... 2.30

**edge®blu**

pH meter with HALO..... 2.34

**HALO® Family**

HALO2..... 2.40

HALO..... 2.58

Hanna Lab App..... 2.74

**Portable..... 2.78**

pH/EC/DO..... 2.78

pH/ORP..... 2.82

HACCP Food and Dairy Specific ..2.86, 2.128

Milk Specific..... 2.90, 2.125

HACCP Meat Specific ..... 2.94, 2.129

Yogurt Specific..... 2.98, 2.126

Cheese Specific..... 2.102, 2.127

Beer Analysis..... 2.106, 2.132

Wine Analysis..... 2.110, 2.134

Direct Soil Specific..... 2.114, 2.121

Plating Bath Specific ..... 2.122

Boiler and Cooling Tower Specific ..... 2.123

Leather and Paper Specific ..... 2.124

Drinking Water..... 2.130

Skin and Scalp Specific ..... 2.136

General..... 2.120, 2.137-2.138

pH/mV Simulator ..... 2.139

**pH Electrodes ..... 2.140**

Introduction..... 2.140

Application Guides..... 2.130

Laboratory Electrodes..... 2.154

Combination ..... 2.154

Special..... 2.158

Rugged..... 2.160

Digital Electrodes..... 2.161

Food Specific Electrodes..... 2.164

Specific Analysis..... 2.168

pH and ORP Half Cells..... 2.171

Reference..... 2.172

Extension Cables..... 2.170

**pH and ORP Solutions.... 2.174**

Introduction..... 2.174

Calibration..... 2.178

Technical..... 2.178

Millesimal..... 2.180

Quick Cal ..... 2.181

Standard..... 2.182

ORP and Sample Preparation ..... 2.186

Electrode Storage..... 2.187

Electrode Cleaning..... 2.188

Electrode Refilling..... 2.190

## Single or Multiparameter Instrumentation

Hanna Instruments offers both single parameter and multiparameter instruments in order to meet a variety of testing requirements.

### Using Single Parameter

Hanna single parameter instruments offer simple, accurate and efficient measurement focused on, as the name implies, a single parameter. They are well suited to applications where one parameter must be tested quickly and easily. They are generally simple to operate and can be used by non-technical users.

### Using Multiparameter

The advantage of Hanna multiparameter instruments is that a user can choose a single meter with the ability to measure multiple parameters.

Multiparameter instruments offer different operating solutions well suited to meeting multiple requirements and are available in two primary configurations:

1. Multiparameter meters that can measure two or three parameters, but only one parameter at a time.
2. Multiparameter meters that offer two or three parameters measured simultaneously—useful on experimental and research applications where the influence between the parameters is an important factor. Multiple inputs provide the capability for simultaneous measurement.

## pH Measurement Input

Hanna meters generally come in two different electrode connection types: BNC or DIN.

**BNC Connector:** A BNC (Bayonet Neil-Concelman) is a common connector used for coaxial cable devices. A BNC connection is generally used for combined electrodes and half-cell electrodes that require a separate reference probe and separate reference input.

**DIN Connector:** A DIN (Deutsches Institut für Normung) is a circular connector. It is used to connect amplified pH electrodes. Electrodes utilizing a DIN connector feature a built-in temperature sensor.

## Temperature Input

Temperature has an effect on pH measurements. As such, temperature compensation is required for accurate measurements. Temperature compensation can be obtained in three ways:

1. A separate probe specifically for measuring temperature
2. A probe with a temperature sensor built-in
3. Manual adjustment for temperature

If a temperature input is not present, many instruments still offer the ability to manually adjust the temperature according to an external temperature reference.

## pH Temperature Compensation

pH readings must be temperature compensated in order to obtain accurate results. The source of temperature measurement can be from a temperature sensor or from a trimmer that is manually adjusted. In either case, the instrument is adjusting the pH reading to compensate for changes in the pH sensor. Compensation in pH provides the actual pH at the temperature of measurement.

## mV Reading

Hanna meters with an mV feature offer the ability to read the mV potential from a pH, ORP, or ISE electrode. The relative mV allows the user to offset the mV difference generated from sensors or references.

## pH/ISE Calibration

pH calibration should be performed daily or every time a new lot of readings is started. Any errors during calibration will affect all the readings until a new calibration is performed. Errors during the calibration process can be eliminated if standard calibration procedures are followed.

Hanna recommends the following standard calibration procedure:

1. Clean and activate the electrode before the calibration.
2. Use fresh pH buffers and standards.
3. Rinse the electrode with purified water during the calibration process to avoid buffer contamination then rinse in buffer or standard.
4. Wait for a stable reading before the calibration point is confirmed.
5. Compensate the pH reading for temperature.

Calibration is a key component to ensuring accurate readings during pH measurement. With this in mind, Hanna supplies each of our pH instruments with a starter package of calibration solutions.

## pH CAL Check™

Many instruments feature Hanna's exclusive pH CAL Check technology. CAL Check is a diagnostics system that ensures accurate pH readings every time. By alerting users to potential problems during the calibration process, the CAL Check system eliminates erroneous readings due to dirty or faulty pH electrodes or contaminated pH buffer solutions during calibration.

During the calibration process, users are prompted with a step-by-step, on-screen tutorial. After calibration, the electrode is evaluated and the condition and response time is provided. Depending upon meter, this may be a graphic of GLP information.

## Calibration Errors

Instruments utilizing Hanna's CAL Check technology can evaluate an electrode during calibration and store a history of parameters that describe the quality of electrode to be compared from one calibration to another. During calibration, a very small degradation of these parameters is normal and can be expected. A big change in the parameters signifies an error in the calibration procedure, such as a dirty electrode.

## pH Buffer Contamination

pH buffers can be contaminated during the calibration procedure by numerous factors such as introducing a contaminated probe, using old buffers, or by reusing buffers. These factors may cause inaccurate calibration and subsequent measurements.

Hanna's CAL Check can often detect issues during calibration, giving warning messages to inform users about the identified issue.

## Response Time of Electrodes

Another parameter that is evaluated during the calibration with certain meters that have CAL Check technology is the response time of an electrode. This is evaluated based on the amount of time necessary to reach stability when the electrode is immersed in a new buffer that has a difference in pH larger than 3 pH units from the old one.

## Offset and Slope of pH Electrode

The offset and slope are the most important parameters that can describe the quality of an electrode. With Hanna's CAL Check technology, the offset of the electrode can be evaluated using one point calibration. Offset is generally determined using a 7.01 pH buffer, however, using CAL Check allows the offset to be based on any calibration point. The acceptable range for offset is  $\pm 30$  mV although a warning may be displayed.

A minimum of two calibration points is necessary to determine the slope. Slope can be evaluated between two calibration points and normally should fall within a range of 92% to 110%, where 100% is 59.16 mV/pH @ 25°C.

## Calibration Points and pH buffers

The calibration of a pH electrode is normally performed using two points: 7 pH, and 4 or 10 pH. This is based on the assumption that the pH electrode is linear from 3 pH up to 10 pH. For the most accurate reading, Hanna recommends using a calibration point closest to the values received during normal measurement.

For a variety of applications and measuring points, many Hanna meters offer the ability to calibrate using more than two points. Many Hanna instruments offer 2, 3, or up to 5 calibration points for enhanced accuracy. pH buffers 1.68, 3.00, 4.01, 6.86, 7.01, 9.18, 10.01, and 12.45 cover the entire pH range.

During calibration, the recognized pH buffers are temperature compensated by the instrument in order to account for pH variation of buffers due to temperature. For example, a 10.01 pH buffer is 10.01 pH only @ 25°C. A table of temperature variation is printed on the label of each pH buffer.

## Custom pH Buffers

Hanna has implemented the concept of custom pH buffers into many of its instruments. This permits the user to add an industry specific buffer for calibration. However, temperature compensation during calibration is not implemented because the temperature variation correlation is unknown.

## Stability During Calibration

The stability of readings is important in order to avoid incorrect calibration. Based on this, the confirmation of a new calibration point is done only after stability is reached. Users are informed during all processes about the stability conditions, and any instability will restart the stability evaluation. The stability criteria during the calibration is more rigorous than during the measurement. This mode used in Hanna instrumentation avoids errors by confirmation of calibration points during unstable readings. This principle is respected in any type of calibration, manual or automatic.

## Out of Calibration Range

This is an important feature during measurement and is considered Good Laboratory Practice (GLP). The measurement is considered more accurate. If the measurement reading is in a range far from the calibration points, the "out of calibration range" message is displayed. The measured value is shown and the user can accept it, but with the warning from the instrument related to possible inaccuracy.

## Calibration Reminder

The calibration reminder, like "out of calibration range," is a GLP warning message. Regularly scheduled calibrations are crucial for accurate and repeatable measurements. A warning reminder will be displayed when the sensor needs calibration. Measurements can still be used under the warning reminder.

## Step-by-Step Calibration

In order to avoid errors during the calibration procedure, the meters display indicators that can be followed by the user for a successful calibration. If necessary, it is possible for the calibration steps to be performed in a different order by the user.

## Additional Features

GLP and ISO standards require the traceability of operations. Hanna's GLP document the quality of calibration, plus information to identify the instrument, operator, and the time at which calibration was performed.

Logging is a common feature for many instruments and can be used to record readings. Two working modes are available: log-on-demand and automatic or interval logging. With log-on-demand, measurements that are considered important can be saved with the press of the log button. With automatic or interval logging, the instrument saves all the readings according to a specified interval. Another logging mode is Auto-End logging or log on stability.

Many Hanna meters include graphic LCD's with features such as tutorials, contextual help, multi-language support, and icons and messages to guide the user through operation and calibration.

# Advanced and Research Grade pH Benchtop Meters



	Two Channels	ISE Measurement	0.001 pH Resolution	Five-point pH Calibration	Five Custom pH Buffers	GLP Features	Real Time Graphing	Data Logging	Incremental Methods	User Accounts	Touchscreen Interface	Wireless Connectivity	USB	PC Connectivity	Fully Customizable	Advanced Customization	Page
HI6221			•	•	•	•	•	•	•	•	•	•	A, C	•	•	•	2.8
HI5222	•	•	•	•	•	•	•	•	•				device	•	•		2.18
HI5221			•	•	•	•	•	•					device	•	•		2.22

# edge®



	Bluetooth® Wireless Technology	Hanna Lab App Compatible	pH Measurement	EC/TDS Measurement	DO Measurement	pH/CAL Check™	0.001 pH Resolution	Five-point pH Calibration	Two Custom pH Buffers	GLP Features	Capacitive Touch Buttons	Data Logging	8 Hour Battery Life	PC Connectivity	Benchtop, Portable & Wall-Mount	3.5 mm probe input	Page
edge®blu	•	•	•			•	•	•	•	•	•	•	•	•	•	•	2.34
edge			•	•*	•*	•	•	•	•	•	•	•	•	•	•	•	2.26
edge pH			•			•	•	•	•	•	•	•	•	•	•	•	2.30

\* with optional compatible edge electrode

# HALO 2

and Hanna Lab App



	Dual-level LCD	pH Range	pH/mV conversion*	0.01 pH Resolution	Five-point pH Calibration	Calibration Buffers	GLP features*	Hanna Lab App Compatible	Bluetooth® Wireless Technology	Hanna Lab App Required	Data Logging*	Body material	Recommended Application	Refillable	CPS™ Clogging Prevention	Easy Clean PVDF Sleeve	Battery Life with Bluetooth Enabled (hours)	Page
HI9810402	•	0.00-14.00	•	•	•	up to 5	•	•	•	No	•	glass	Lab	•			500	2.42
HI9810412	•	0.00-12.00	•	•		up to 4	•	•	•	No	•	glass	Lab				500	2.43
HI9810422	•	0.00-12.00	•	•		up to 4	•	•	•	No	•	PEI	Field				500	2.44
HI9810302	•	0.00-12.00	•	•		up to 4	•	•	•	No	•	PVDF	Soil		•		500	2.45
HI9810432	•	0.00-12.00	•	•		up to 4	•	•	•	No	•	glass	Cosmetic Creams	•			500	2.46
HI9810372	•	0.00-12.00	•	•		up to 4	•	•	•	No	•	glass	Skin & Scalp				500	2.47
HI9810442	•	0.00-12.00	•	•		up to 4	•	•	•	No	•	glass	Leather & Paper				500	2.48
HI9810312	•	0.00-12.00	•	•		up to 4	•	•	•	No	•	Titanium	Beer				500	2.49
HI9810332	•	0.00-12.00	•	•		up to 4	•	•	•	No	•	glass	Wine	•	•		500	2.50
HI9810352	•	0.00-12.00	•	•		up to 4	•	•	•	No	•	Titanium	Sushi				500	2.51
HI9810342	•	0.00-12.00	•	•		up to 4	•	•	•	No	•	glass	Milk				500	2.52
HI9810322	•	0.00-12.00	•	•		up to 4	•	•	•	No	•	PVDF	Cheese				500	2.53
HI9810362 / HI9810452	•	0.00-12.00	•	•		up to 4	•	•	•	No	•	PVDF	Meat		•		500	2.54
HI9810392	•	0.00-12.00	•	•		up to 4	•	•	•	No	•	PVDF	Chocolate		•		500	2.55
HI9810382	•	0.00-12.00	•	•		up to 4	•	•	•	No	•	PVDF	Bread & Dough				500	2.57

\*With Hanna Lab App

# HALO®

and Hanna Lab App



	pH Range	0.001 pH Resolution	Five-point pH Calibration	Calibration Buffers	GLP features	Hanna Lab App Compatible	Bluetooth® Wireless Technology	Hanna Lab App Required	Data Logging	Body material	Recommended Application	CPS™ Clogging Prevention	Battery Life (hours)	Page
HI11312	0.00-13.00	•	•	up to 7	•	•	•	yes	•	glass	lab		500	2.60
HI11102	0.00-12.00	•	•	up to 7	•	•	•	yes	•	glass	lab		500	2.61
HI13302	0.00-12.00	•	•	up to 7	•	•	•	yes	•	glass	lab, test tube		500	2.62
HI10832	0.00-13.00	•	•	up to 7	•	•	•	yes	•	glass	lab, small sample		500	2.63
HI12302	0.00-12.00	•	•	up to 7	•	•	•	yes	•	PEI	field		500	2.64
FC2022	0.00-12.00	•	•	up to 7	•	•	•	yes	•	PVDF	food		500	2.65
HI10482	0.00-12.00	•	•	up to 7	•	•	•	yes	•	glass	wine, must and juice	•	500	2.67
FC2142	0.00-13.00	•	•	up to 7	•	•	•	yes	•	titanium	brewing		500	2.69
HI12922	0.00-12.00	•	•	up to 7	•	•	•	yes	•	glass	direct soil		500	2.71
HI14142	0.00-12.00	•	•	up to 7	•	•	•	yes	•	glass	flat surfaces		500	2.72
HI10532	0.00-12.00	•	•	up to 7	•	•	•	yes	•	glass	food		500	2.73

## Laboratory Grade pH Benchtop Meters



	mV	CAL Check	Temperature Measurement	Automatic Calibration	0.001 pH Resolution	Five-point pH Calibration	Two Custom pH Buffers	GLP Features	Data Logging	PC Connectivity	Magnetic Stirrer	Built-in Printer	Built-in Solution Holders	Analog Output	Page
HI122	•	•	•	•	•	•	•	•	•	•	•	•	•	•	2.24

## Waterproof Portable pH Meters



	ISE Measurement	mV Measurement	Temperature Measurement	0.001 pH Resolution	pH Sensor Check™	CAL Check	Automatic Calibration	Automatic Temperature Compensation	Log on Demand (records)	Two-point pH Calibration	Three-point Calibration	Five-point Calibration	Custom Buffers	Backlit LCD	GLP Features	PC Connectivity	Auto-off	Page
HI98199	•	•	•	•	•	•	•	•	45k	•	•	•	•	•	•	•	•	2.78
HI98190	•	•	•	•	•	•	•	•	200	•	•	•	•	•	•	•	•	2.82
HI991003	•	•	•	•	•	•	•	•	•	•	•	•	•	•	•	•	•	2.120
HI991001	•	•	•	•	•	•	•	•	•	•	•	•	•	•	•	•	•	2.120



## Application Specific Waterproof Portable Meters



	Temperature Measurement	BEPS	Automatic Temperature Compensation	Two-Point pH Calibration	Waterproof	Soil Measurement	Plating Baths	Boiler & Cooling Towers	Leather & Paper	Foodcare	Milk	Yogurt	Cheese	General Purpose Food	Drinking Water	Beer Analysis	Wine Analysis	Meat Measurement	pH of Skin	Page
HI98161	•	•	•	•						•										2.86
HI98162	•	•	•	•							•									2.90
HI98163	•	•	•	•														•		2.94
HI98164	•	•	•	•								•								2.98
HI98165	•	•	•	•									•							2.102
HI98167	•	•	•	•											•					2.106
HI98169	•	•	•	•													•			2.110
HI98168	•	•	•	•	•															2.114
HI99121	•	•	•	•	•	•														2.121
HI99131	•	•	•	•	•		•													2.122
HI99141	•	•	•	•	•			•												2.123
HI99171	•	•	•	•	•				•											2.124
HI99181	•	•	•	•	•														•	2.136
HI99162	•	•	•	•	•						•									2.125
HI99164	•	•	•	•	•							•								2.126
HI99165	•	•	•	•	•								•							2.127
HI99161	•	•	•	•	•									•						2.128
HI99163	•	•	•	•	•													•		2.129
HI99192	•	•	•	•	•										•					2.130
HI99151	•	•	•	•	•											•				2.132
HI99111	•	•	•	•	•													•		2.134

## Other Portable Meters

	mV Measurement	Temperature Measurement	Automatic Calibration	Automatic Temperature Compensation	HOLD Function	Two-Point pH Calibration	Low Battery Indicator	Pre-amplified pH Electrode	Auto-off	Page
HI8424	•	•	•	•	•	•	•		•	2.137
HI8314-1	•	•		•		•	•	•		2.138
HI83141-1	•	•		•		•	•			2.138
HI931001	•									2.139
HI9310014 (Pool Line)	•									2.139



## Advanced pH/ORP Meter

pH/ORP and Temperature



HI6221 is a streamlined benchtop meter with a large touch screen display, comprised of a housing and an integrated pH / ORP measurement module.

Compact and easy to operate, the benchtop meter is delivered with Hanna Instruments HI1131B double junction combination pH electrode, together with HI7662-TW temperature probe.

HI1131B is a glass body, double junction, refillable pH electrode with an indicating sensor made of High Temperature (HT) glass. The double junction reference and HT glass design allow the HI1131B to be used in a wide variety of applications including samples with metals and elevated temperatures.

Probe connection to the unit is secured through a galvanically isolated BNC connection.

HI7662-TW stainless steel temperature probe allows the meter to automatically temperature compensate (ATC) pH measurements.

This system responds to a complex range of measurement and monitoring requirements, providing accuracy, reproducibility, and reliability.

HI6221 is supplied with an electrode holder that has a flexible arm. The holder can be mounted quickly and provides secure support for electrodes while taking measurements in sample containers.

## User interface

- 7-inch capacitive touch screen with multi-touch support
- Capacitive touch back, home and system menu keys
- User-friendly icons and symbols allow users to easily navigate and interpret the instrument functions.
- The user can select between five different views:
  - Basic measurement configuration
  - Simple GLP with calibration information
  - Full GLP with electrode status and calibration point details
  - Live updated, interactive graph
  - Tabulated data with date, time, and notes

## Measurement

- Measure pH/mV (pH) or mV/Rel. mV (ORP) with temperature
- Application-specific profiles allow quick and direct measurement without the need to update the sensor and system settings

- Active log during measurement
- Measurement stability indicator (using the Stability Criteria setting)
- Reading modes: direct and direct/autohold
- Temperature compensation can be Automatic (using temperature probe) or set manually
- Audible and/or alarm messages for measurements outside of predefined limits
- Galvanic isolation for pH/ORP measurement

## Calibration

- 5-point pH calibration with automatic recognition for standard buffers (Hanna and NIST buffers)
- Choice of standard or custom buffers for calibration
- Non-volatile memory saves data and settings

## Logging

- Data log collection of at least 1,000,000 data points (with time and date stamp)
- Logging types: manual, automatic, autohold
- Sample ID for manual and Autohold data

## Connectivity features & services

- Transfer logged data to a USB thumb drive
- Log files that include measurements and calibration data (as .csv file)
- FTP and email for log export via Ethernet and Wi-Fi connection
- USB type A for USB stick, keyboard, and printer
- USB type C for USB stick and PC connection

## Help section for meter guidance

- Video support presentation of main functionalities





### 1. Capacitive touch screen with multi-touch support

The benchtop unit has a 7-inch color display with 800 x 480p resolution. The capacitive, multi-touch screen supports video playback and data plotting.

### 2. Back key

### 3. Home key

### 4. System Menu key

This key will enter the system menu where User accounts, System Settings, and Logging can be configured. The Help menu is also accessed on the system menu screen.

### 5. Stability indicator

### 6. Current date

### 7. Current time

### 8. pH reading

### 9. mV reading

### 10. pH electrode icon

### 11. Calibration information: Electrode condition, Offset, Slope, Date and Time

### 12. Buffer trays

### 13. Temp. reading and Temp. compensation status

### 14. Measurement setup menu

Opens sensor setup parameters.

### 15. User name (default shown)

### 16. Direct/Autohold Readings

When Direct/Autohold is selected, measurement reading is held on display when measurement stability is reached. This option removes the subjective nature of stability as a measurement that has not reached equilibrium will not be used.

When not selected, sample measurements are displayed continuously.

### 17. Logging space availability

### 18. Logging start

### 19. USB connection status

### 20. Peripheral connection status

### 21. Wireless network connection status

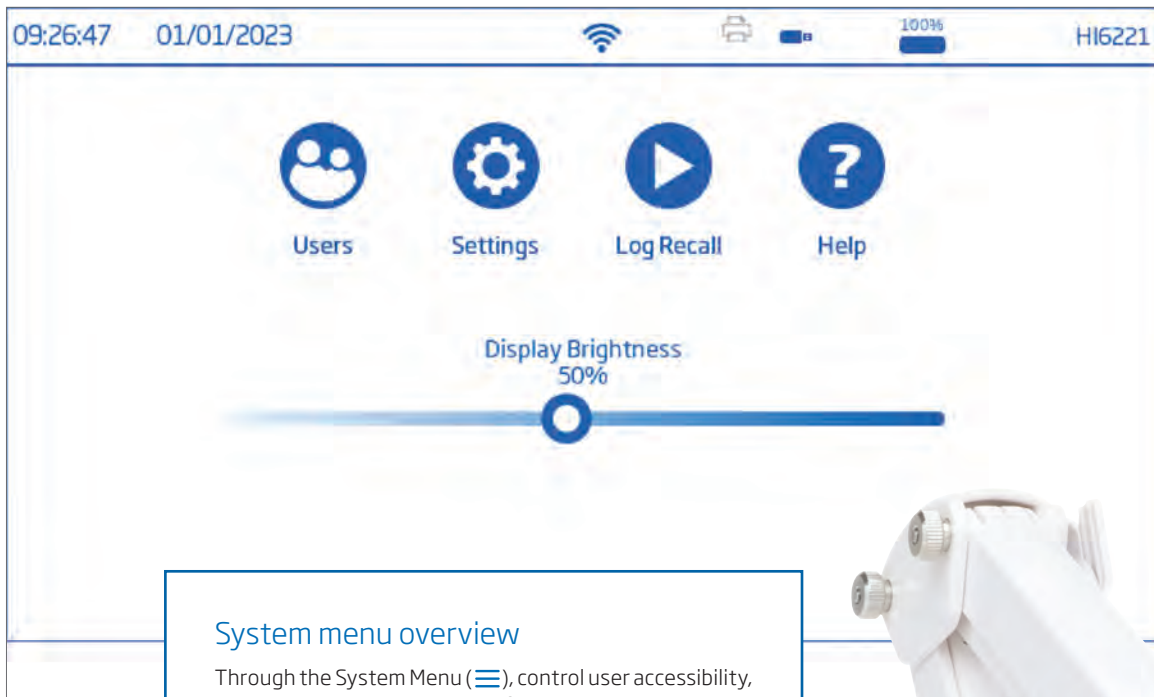

**System menu overview**

Through the System Menu (☰), control user accessibility, system and connectivity configuration, access logged data and video-supported help.

- Add and delete user accounts through Users (👤).
- Access Network Connectivity, System and Info tabs through Settings (⚙️).
- Log Recall (▶️) recalls stored log sessions (Automatic continuous logging, Manual, or Autohold).
- Help (❓) guides users with video-supported help.



pH

benchtop



## Users

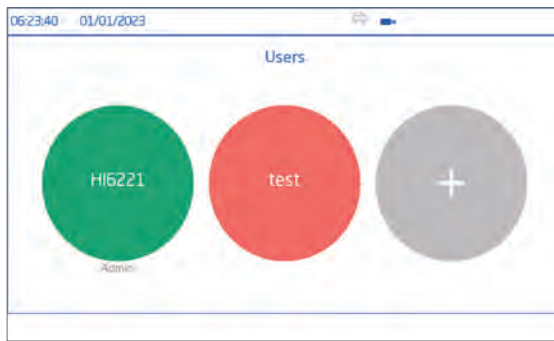

### Custom Users

New administrator or standard user accounts can be created. Standard accounts can be configured for specific accessibility.

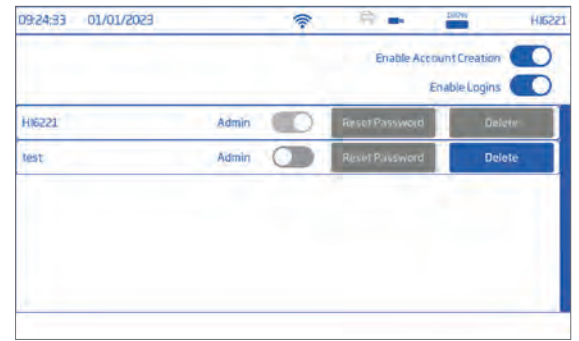

### User Account Management

Administrators can create and manage accounts from the Account Management Screen.



## Settings

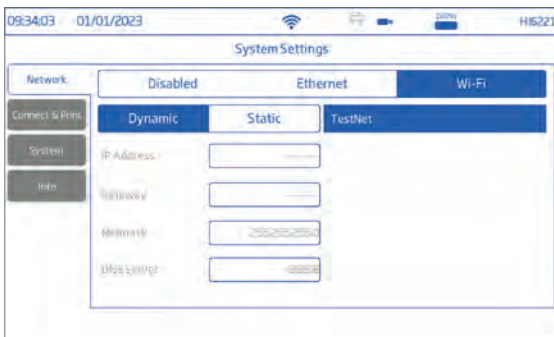

### Network Screen

Determine how measurement logs are shared through network settings. Users can select network to be connected via Ethernet or Wi-Fi, or Disabled.

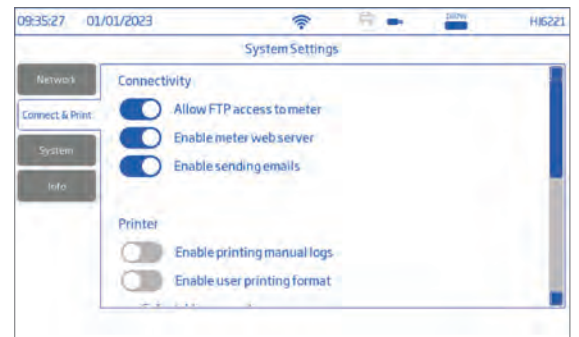

### Connect and Print Screen

Activate connectivity options to allow the meter to connect to other devices.

- FTP access to meter, permits log file transfer to a FTP site and to connect the meter FTP server to a client for log download.
- Meter web server, permits log file download to a web client.
- Sending emails, permits log files to be transferred by email.

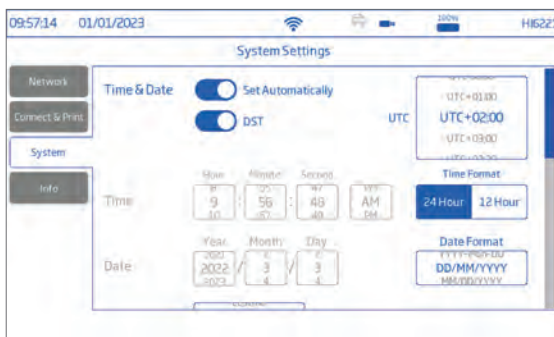

### System Screen

The system screen enables users to configure options such as: Time, Date, Language, Meter ID, Decimal Separator, Backlight Saver, Audible signals, Startup Tutorial, and Factory Settings restore.

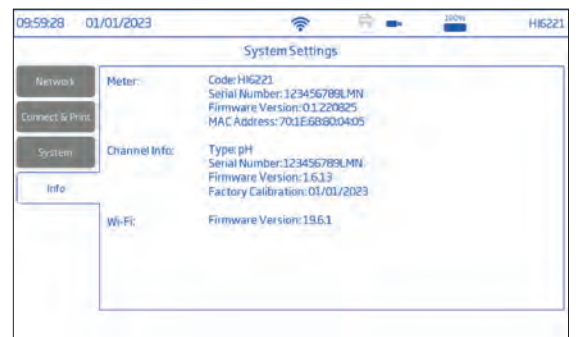

### Info Screen

Displays information on meter, channel serial number, and Wi-Fi firmware version.



## Log Recall

Name	Parameter	Start/Stop	#Samples
mV_20230101070237.csv	mV	10:02:37 03/03/2022 10:03:21 03/03/2022	45
pH_20230101070155.csv	pH	10:01:58 03/03/2022 10:02:27 03/03/2022	30
pH_20230101070403.csv	pH	10:04:03 03/03/2022 10:04:32 03/03/2022	10
relmV_20230303070334.csv	Rel. mV	10:03:34 03/03/2022 10:03:53 03/03/2022	20

### Log History and Sharing

The item allows users access and management (selection, deletion, and sharing) of measurement data. Only the user who generated the data has access to the logs created by that user.

Data can be viewed tabulated (complete with date, time, and notes), or plotted (as graph).

Log files can be shared via USB, FTP, web server and email.

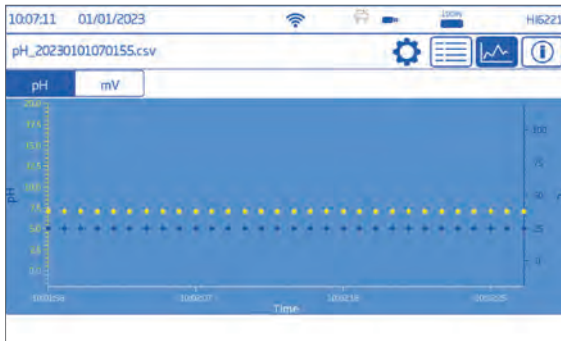

### Graph View

pH	mV	T(°C)	Date	Time	Notes
7.044	-2.4	25.0	03/03/2022	10:01:58	"H"
7.044	-2.4	25.0	03/03/2022	10:01:59	"H"
7.044	-2.4	25.0	03/03/2022	10:02:00	"H"
7.044	-2.4	25.0	03/03/2022	10:02:01	"H"
7.044	-2.4	25.0	03/03/2022	10:02:02	"H"
7.044	-2.4	25.0	03/03/2022	10:02:03	"H"
7.044	-2.4	25.0	03/03/2022	10:02:04	"H"
7.044	-2.4	25.0	03/03/2022	10:02:05	"H"
7.044	-2.4	25.0	03/03/2022	10:02:06	"H"
7.044	-2.4	25.0	03/03/2022	10:02:07	"H"

### Table View

**GENERAL INFORMATION**  
 Username: HI6221  
 Profile: default\_pH

**INSTRUMENT**  
 Instrument Name: HI6221-01  
 Serial Number: 129456789LMN  
 Firmware Version: 01.220825

**CHANNEL INFO**  
 Channel Number: 1  
 Module: General

### Log Detail

Tapping the information icon displays log details such as user and profile name, instrument name and serial number, channel, lot information, as well as GLP data.



## Help

**Hanna Tutorial System**

- 1. HI6221 First Look
- 2. Getting Started
  - 2.1. Get familiar with functionalities
  - 2.2. Users
  - 2.3. Meter settings
  - 2.4. Setting measurement
- 3. General Operations
- 4. General Operations
- 5. Troubleshooting guide
- 6. Accessories and Warranty

**2.1. Get familiar with functionalities**  
**Screens explained**  
 Main View - This screen shows the current measurement according to the measurement settings and give access to the user calibration and measurement settings options.

Time	pH	mV	T(°C)	Date	Time	Notes
10:01:58	7.540	-2.4	25.0	03/03/2022	10:01:58	"H"
10:01:59	7.540	-2.4	25.0	03/03/2022	10:01:59	"H"
10:02:00	7.540	-2.4	25.0	03/03/2022	10:02:00	"H"
10:02:01	7.540	-2.4	25.0	03/03/2022	10:02:01	"H"
10:02:02	7.540	-2.4	25.0	03/03/2022	10:02:02	"H"
10:02:03	7.540	-2.4	25.0	03/03/2022	10:02:03	"H"
10:02:04	7.540	-2.4	25.0	03/03/2022	10:02:04	"H"
10:02:05	7.540	-2.4	25.0	03/03/2022	10:02:05	"H"
10:02:06	7.540	-2.4	25.0	03/03/2022	10:02:06	"H"
10:02:07	7.540	-2.4	25.0	03/03/2022	10:02:07	"H"

Main Menu - This screen gives the user access to the 5 main icons

**Hanna Tutorial System**

- 1. HI6221 First Look
- 2. Getting Started
  - 2.1. Get familiar with functionalities
  - 2.2. Users
  - 2.3. Meter settings
  - 2.4. Setting measurement
- 3. General Operations
- 4. General Operations
- 5. Troubleshooting guide
- 6. Accessories and Warranty

**2.4. Setting up measurement**  
 Your measurement screen can be configured by pressing **Q**.

**Channel Settings**

Channel: pH  
 Mode: mV  
 Units: mV  
 Range: 0.00  
 Resolution: 0.01  
 Temperature: 25.00  
 Compensation: ON  
 Slope: 0.00  
 Slope Units: %/°C  
 Slope Range: 0.00  
 Slope Resolution: 0.01  
 Slope Compensation: ON  
 Check/Cancel

**READING**

Mode: pH, mV, Rel. mV

### On-board Help

The HELP menu supports users with a brief overview of the system's main functionalities through text and video tutorials.



## Measurement Setup Configuration

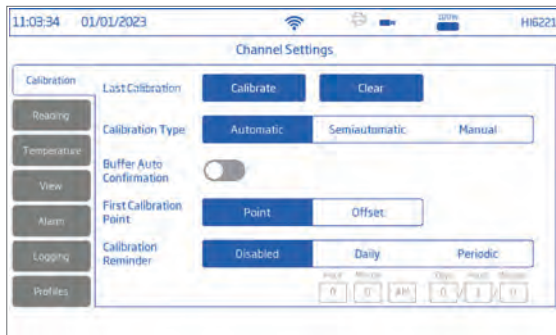

### Calibration

Customize calibration options such as Last Calibration, Automatic, semi-automatic or manual calibration, First Calibration Point, daily or periodic Calibration Reminder, and buffer Groups.



### Buffer groups

This option allows the user to select Buffers in Use for calibrating a pH electrode when using the Automatic calibration type.

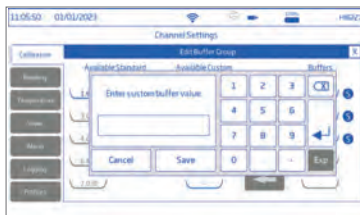

### Custom Buffers

Custom buffers can be created.



### Reading

Customize measurement options such as Parameter, Resolution, Stability Criteria, Reading Mode



### Temperature

Customize temperature options such as Automatic or manual temperature Source, °C, °F, or K temperature Unit, Manual Temperature input, Isopotential Point.

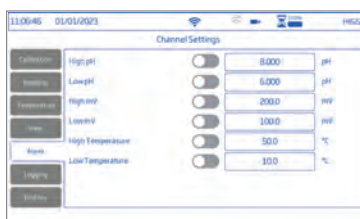

### Alarm configuration

Alarm configuration allows users to set the high and low threshold limits for the measured parameters. When the parameter is enabled and the measurement exceeds the high-limit value or drops below the low-limit value, the alarm is triggered and will appear on the message banner along with an audible alarm (if Alarm Beepers is enabled).



### Logging

Logging Type (Automatic, Manual or Autohold), Sampling Period (Automatic), File Name (Manual and Autohold), and Sample ID (Manual and Autohold) can be configured under this option menu.



### Profiles

A profile is a sensor setup complete with required measurement unit, temperature unit, display preference, and alarm threshold options.

Once saved the profile can be loaded for applications that require similar configurations.



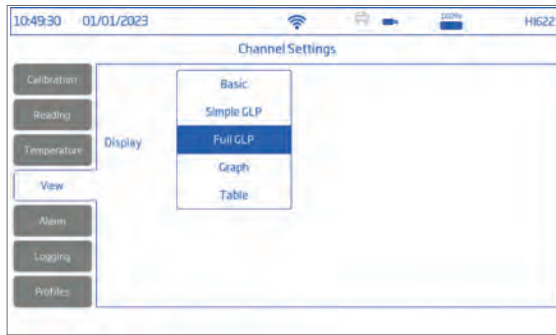

### View Configuration

This screen allows users to select the preferred display configuration.

pH options: Basic, Simple GLP, Full GLP, Graph, Table  
 mV options: Basic, Graph, Table  
 Rel. mV options: Simple GLP, Basic, Graph, Table

### Basic View

Basic screen displays the measured value, measurement unit as well as temperature source.



### Simple GLP View

In addition to data displayed when Basic option is selected, Simple GLP screen also displays: last calibration date and time, Offset value, average slope (Avg. Slope), and electrode condition (Condition).



### Full GLP View

In addition to data displayed when Simple GLP option is selected, Full GLP screen also displays: electrode symbol, used buffers trays together with calibration date, time, and temperature probe status.

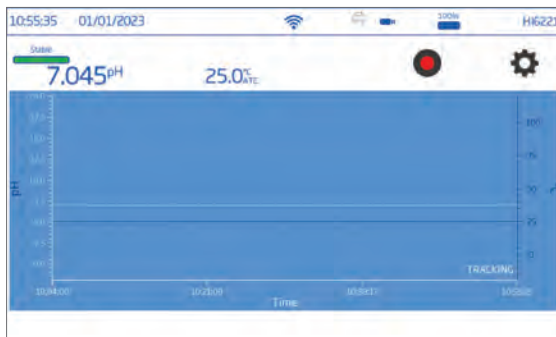

### Graph View

When Graph is selected, the measured value is plotted as a graph.



### Table

When Table is selected, the measured values are displayed tabulated (complete with date, time, and notes made during logging). The newest data is displayed on the top of the table.

## Electrode Holder

HI6221 is supplied with the HI764060 electrode holder featuring a flexible arm. The holder can be mounted on either side quickly and provides secure support for electrodes while taking measurements in sample containers.



## Rear Ports

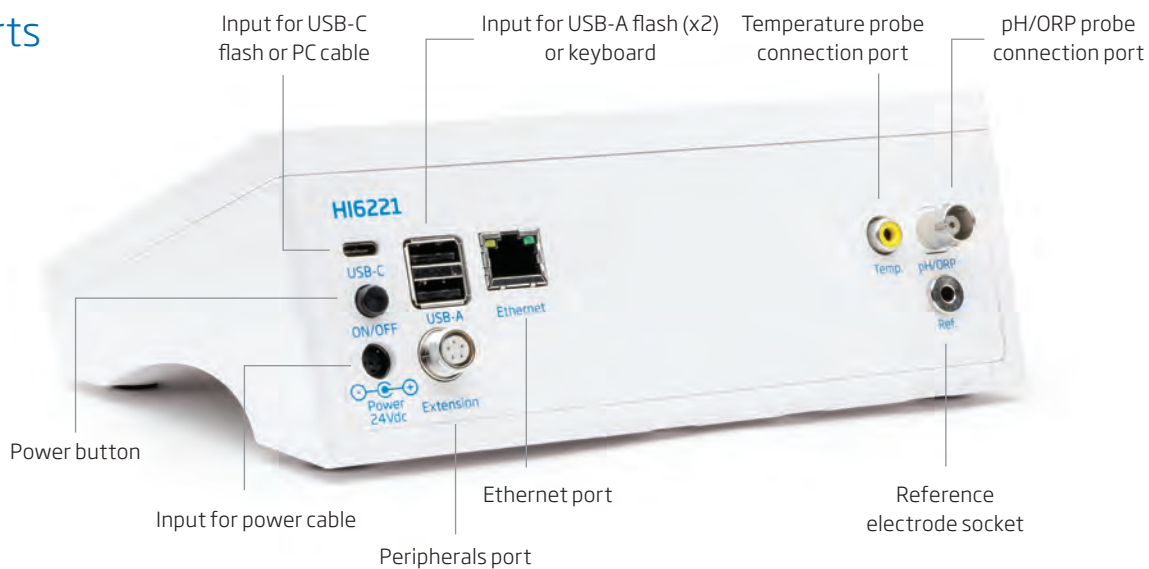

Specifications	HI6221	
pH	Range	-2.0 to 20.0 pH; -2.00 to 20.00 pH; -2.000 to 20.000 pH
	Resolution	0.1 pH; 0.01 pH; 0.001 pH
	Accuracy	±0.1 pH; ±0.01 pH; ±0.002 pH (±1 last significant digit)
mV	Range	±2000.0 mV
	Resolution	1 mV; 0.1 mV
	Accuracy	±0.2 mV ±1 last significant digit
Temperature	Range	-20.0 to 120.0 °C; -4.0 to 248.0 °F; 253.0 to 393.0 K
	Resolution	0.1 °C / 0.1 °F / 0.1 K
	Accuracy	±0.2 °C / ±0.4 °F / ±0.2 K
Relative mV offset range		±2000.0 mV
pH Calibration	Calibration points	Up to 5
	Type	Automatic; Semiautomatic; Manual
	Standard buffers	Hanna and NIST pH 1.68, 3.00, 4.01, 6.86, 7.01, 9.18, 10.01, 12.45
	Custom buffers	Up to 5
	Custom group	Up to 5
	1st calibration point	Offset or Points (user setting)
	Reminder	Disabled Daily: 0 min. to 23 hours and 59 min. Periodic: 1 min. to 500 days, 23 hours and 59 min.
Temperature Compensation		Automatic or Manual
Reading	Modes	Direct; Direct/Autohold
	Stability criteria	Accurate; Medium; Fast
	Isopotential	7.000 or 4.010
	Sampling rate	1000 ms
pH Views	Basic	Measurement (pH, mV, Rel.mV, Abs.mV) Temperature, Stability status
	Simple GLP	Basic view information Last calibration date, electrode offset, average slope, and electrode condition
	Full GLP	Simple GLP information and calibration point details
	Table	Measurements updated every second are displayed in table
	Graph (Plot)	pH (or mV) and temperature versus time graph can be panned or zoomed (pinch-to-zoom technology)
Logging	Type	Automatic, Manual, Autohold
	Number of records	50 000 maximum per file Stores at least 1 000 000 data points per user
	Automatic interval	1, 2, 5, 10, 30 seconds 1, 2, 5, 10, 15, 30, 60, 120, 150, 180 minutes
	Sample ID	Incremental mode
	Export option	.csv file format
Users	Up to 9 users and admin. account (default)	
Connectivity	USB-A	2 ports for keyboard input or USB thumb drive
	USB-C	1 port for PC connectivity and USB-C type thumb drive
	Wi-Fi & Ethernet	FTP Web server Log transfer and download Email
	RS232	Connecting peripherals
Power supply	DC adapter 100-240AC to 24VDC 2.5A	
Environment	0 - 50 °C / 32 - 122 °F / 273 - 323 K maximum 95% RH non-condensing	
Dimensions	205 x 160 x 77 mm (8.0 x 6.2 x 3.0")	
Weight	Approximately 1.2 kg (26.5 lbs.)	
Ordering Information	<b>HI6221</b> is supplied with HI1131B pH electrode; HI7662-TW temperature probe; pH calibration starter kit consisting of: pH 4.01 buffer solution sachet (2 pcs.); pH 7.01 buffer solution sachet (4 pcs.); pH 10.01 buffer solution sachet (2 pcs.); HI700601 electrode cleaning solution sachet (2 pcs.); HI7082 3.5M KCl electrolyte solution (30 mL); HI764060 electrode holder; capillary pipette; 24 VDC power adapter; USB-C to USB-A cable; quick reference guide with instrument quality certificate.	

## Research Grade Meter

pH/ORP/ISE and Temperature



The HI5222 is a research grade benchtop pH/mV/ISE dual channel meter that is completely customizable with a large color LCD, capacitive touch keys, and USB port for computer connectivity.

The HI5222 features two galvanically isolated BNC connections for use with the expansive line of pH, ISE, and ORP electrodes that Hanna Instruments offers. The meter is supplied with the HI1131B glass body, double junction, combination pH electrode that operates over a wide temperature range from 0 to 100°C. All readings are automatically compensated for temperature variations with the separate HI7662-T temperature probe that is included.

As a pH meter the HI5222 can be calibrated up to five points with eight pre-programmed buffers or five custom buffers. The HI5222 features Hanna's exclusive CAL Check™ to alert the user to potential problems during the pH calibration process. Alerts displayed during calibration include "Electrode Dirty/Broken" and "Buffer Contaminated." The overall probe condition based on the offset and slope characteristic of the electrode are displayed as a percentage after calibration is complete.

As an ISE meter the HI5222 can be calibrated up to five points with a choice of five fixed standards or five user standards defined

in any concentration unit. The calibration data including date, time, standards used, and slope can be viewed at any time along with the current measurement by selecting the Good Laboratory Practice (GLP) display option.

Three selectable logging modes are available: automatic, manual, and AutoHold logging. Up to 100,000 data points per channel can be recorded in 100 lots, 50,000 records max/lot and exported to a computer for data review and storage.

## Customizable User Interface

The user interface of the HI5222 allows the user to show measurements in various modes: basic measurement with or without GLP information, real-time graphing, and logging data. Calibration stability criteria can be adjusted to fast, moderate, or accurate. Programmable alarm limits can be set to inside or outside allowable limits.

## Color Graphic LCD

The HI5222 features a color graphic LCD with on-screen help, graphic, and custom color configurations. The display allows for real-time graphing and the use of virtual keys provide for an intuitive user interface.

## Capacitive Touch

The HI5222 features sensitive capacitive touch buttons for accurate keystrokes when navigating menus and screens. There are four dedicated keys that are used for routine operations including calibration and switching measurement modes and four virtual keys that change based upon use. The capacitive touch technology ensures the buttons never get clogged with sample residue.

## Two Galvanically Isolated pH/ORP/ISE Channels

The HI5222 has two input channels that can be used for pH, ORP, and ISE electrodes. Each input channel has connectors for BNC probes, reference probes, and a temperature sensor. Each channel is galvanically isolated which means that two measurement probes can be in the same solution at the same time and the voltages produced will not interfere with each other.

## Choice of Calibration

Automatic buffer recognition, semi automatic, and direct manual entry pH calibration options are available for calibrating up to five points, from a selection of eight standard buffers and up to five custom buffers.

## GLP Data

HI5222 includes a GLP feature that allows users to view calibration data and calibration expiration information at the touch of a key. Calibration data include date, time, buffers used for calibration, and electrode offset and slope characteristics.

## CAL Check™

CAL Check alerts users to potential problems during the calibration of the pH electrode. Indicators include "Electrode Dirty/Broken," "Buffer Contaminated," electrode response time, and the overall probe condition as a percentage that is based on the offset and slope characteristics.

## ISE Measurement with Choice of Concentration Units

The HI5222 allows for calibration and readings in choice of concentration units. The choices of concentration units include ppt, g/L, mg/mL, ppm, mg/L, µg/mL, ppb, µg/L, mg/mL, M, mol/L, mmol/L, %w/v, and a user-defined unit.

## ISE Measurement with Incremental Methods

The known addition, known subtraction,

analyte addition, and analyte subtraction incremental methods are pre-programmed into the HI5222. Simply follow the on screen guided procedure and the meter will perform the calculation automatically allowing for a higher level of accuracy to be obtained as compared to a direct ISE measurement.

## Data Logging

Three selectable logging modes are available on the HI5222: automatic, manual, and AutoHold logging. Automatic and manual logs up to 100 lots with 50,000 records max/lot with up to 100,000 total data points per channel. Automatic logging features the option to save data according to sampling period and interval.

## Data Transfer

Data can be transferred to a PC with USB cable and HI92000 software (both sold separately).

## Contextual Help

Contextual help is always available through a dedicated "HELP" key. Clear tutorial messages and directions are available on-screen to quickly and easily guide users through setup and calibration. The help information displayed is relative to the setting/option being viewed.

## CAL Check Screens

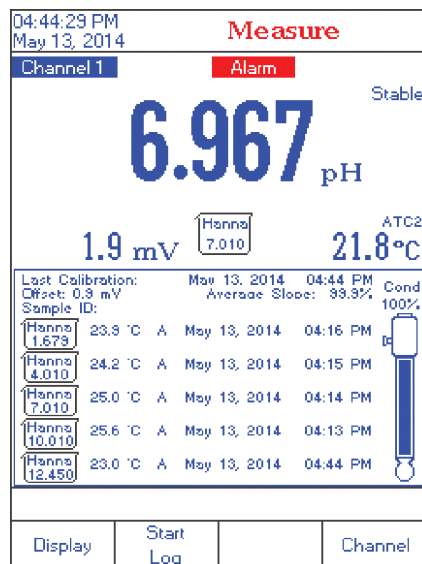
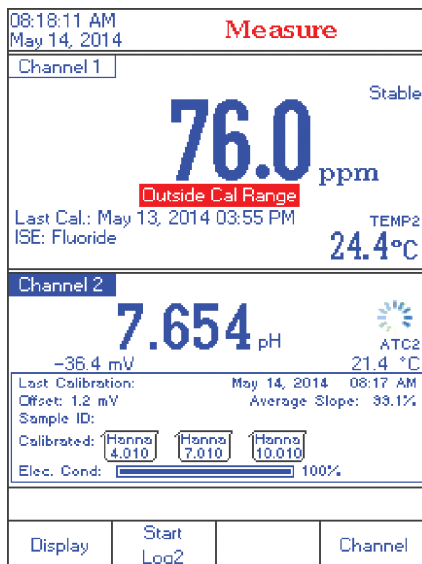
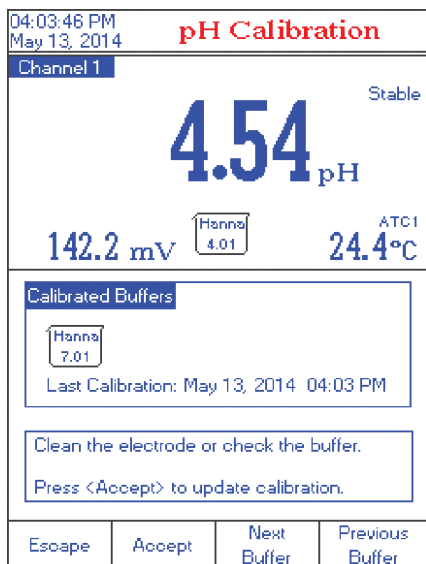

## Additional Features by Screen

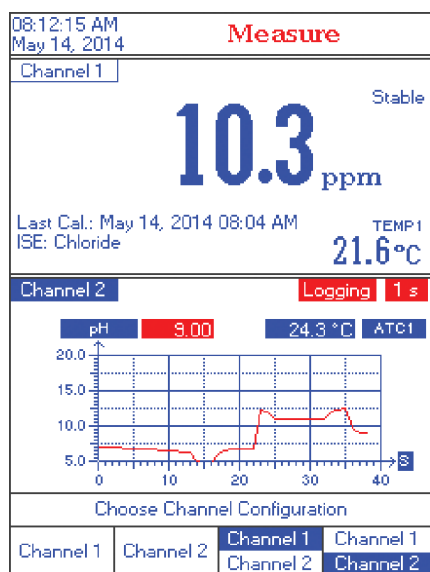

Channel Configuration

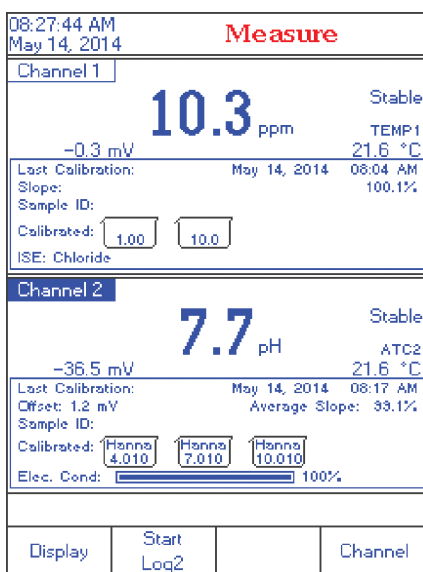

Good Laboratory Practices

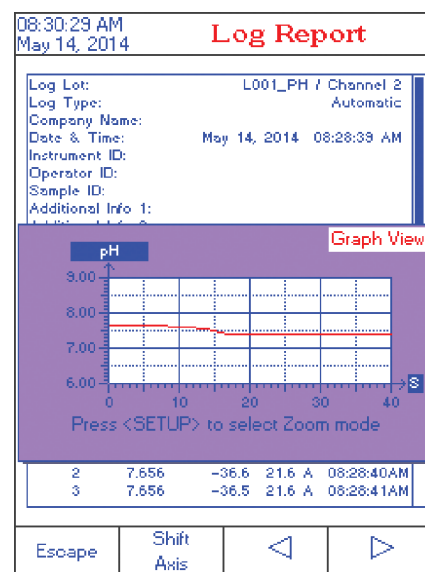

Log Recall

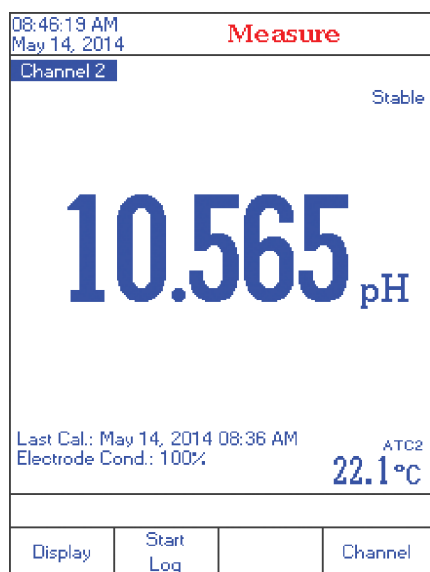

Basic Display

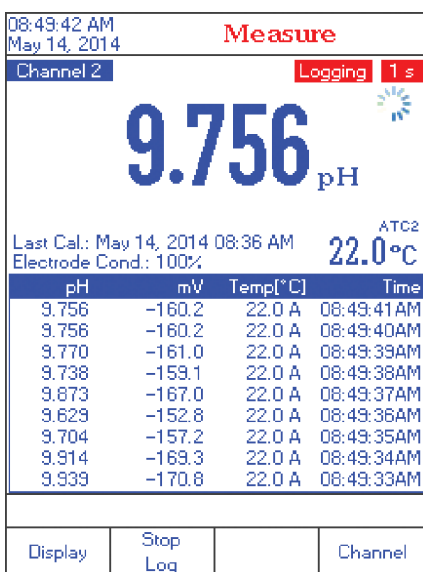

Real-Time Logging

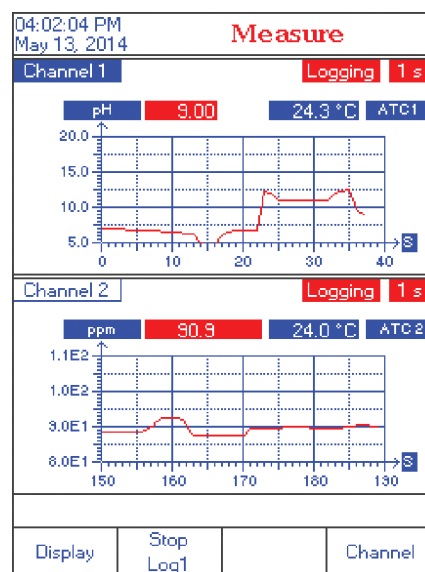

Simultaneous Dual Channel Graphing



## Dual Channels

The two measurement channels of the HI5222 are galvanically isolated to eliminate noise and instability.

In ISE mode, this instrument provides a choice of several incremental methods. Communication is via opto-isolated USB.



## Specifications

## HI5222

pH	Range	-2.0 to 20.0 pH; -2.00 to 20.00; -2.000 to 20.000 pH
	Resolution	0.1 pH; 0.01 pH; 0.001 pH
	Accuracy	±0.1 pH; ±0.01 pH; ±0.002 pH ±1 LSD
	Calibration	automatic, up to five point calibration, eight standard buffers available (1.68, 3.00, 4.01, 6.86, 7.01, 9.18, 10.01, 12.45), and five custom buffers
	Temperature Compensation	automatic or manual from -20.0 to 120.0°C/-4.0 to 248.0°F/253.15 to 393.15K
mV	Range	±2000 mV
	Resolution	0.1 mV
	Accuracy	±0.2 mV ±1 LSD
	Relative mV Offset Range	±2000 mV
ISE	Range	1 x 10 <sup>-6</sup> to 9.99 x 10 <sup>10</sup> concentration
	Resolution	1; 0.1; 0.01; 0.001 concentration
	Accuracy	±0.5% (monovalent ions); ±1% (divalent ions)
	Calibration	automatic, up to five-point calibration, seven fixed standard solutions available for each measurement unit, and five user defined standards
Temperature*	Range	-20.0 to 120°C; -4.0 to 248.0°F; 253.15 to 393.15K
	Resolution	0.1°C; 0.1°F; 0.1K
	Accuracy	±0.2°C; ±0.4°F; ±0.2K
Additional Specifications	pH Electrode	HI1131B glass body pH electrode with BNC connector and 1 m (3.3') cable (included)
	Temperature Probe	HI7662-W stainless steel temperature probe with 1 m (3.3') cable (included)
	Input Channel(s)	2 pH/ORP/ISE
	GLP	calibration points, calibration time stamp, probe offset, slope, date, time and buffers/standards used
	Logging	<b>record:</b> Up to 100 lots, 50,000 records max/lot / maximum 100,000 data points/channel; <b>interval:</b> 14 select table between 1 second and 180 minutes; <b>type:</b> automatic, manual, AutoHOLD;
	Display	color graphic LCD 240x340 pixels
	PC Connection	USB
	Power Supply	12 VDC adapter (included)
	Environment	0 to 50°C (32 to 122°F; 273 to 323K) RH max 95% non-condensing
	Dimensions	160 x 231 x 94 mm (6.3 x 9.1 x 3.7")
Weight	1.2 kg (2.64 lbs.)	
Ordering Information	<p><b>HI5222-01</b> (115V) and <b>HI5222-02</b> (230V) are supplied with HI1131B pH electrode, HI7662-W temperature probe, pH 4.01 buffer solution sachet (2), pH 7.01 buffer solution sachet (2), HI700601 electrode cleaning solution sachet (2), HI7082 3.5M KCl electrolyte solution (30 mL), HI76404W electrode holder, 12 VDC adapter, capillary dropper pipette, quality certificate, quick start guide, and instruction manual.</p> <p><b>HI5222-03</b> includes the above without electrode.</p>	

(\*) Reduced to actual probe limits

# Research Grade Meter

pH/ORP and Temperature



The HI5221 is a research grade benchtop pH/mV meter that is customizable with a large color LCD, capacitive touch keys, and USB port for computer connectivity.

The HI5221 features a universal BNC connection for use with the expansive line of pH and ORP electrodes that Hanna Instruments offers. The meter is supplied with the HI1131B glass body, double junction, combination pH electrode that operates over a wide temperature range from 0 to 100°C. All readings are automatically compensated for temperature variations with the separate

HI7662-T temperature probe that is included.

The HI5221 can be calibrated up to five points with a choice of eight pre-programmed buffers or five custom buffers. The HI5221 features Hanna's exclusive CAL Check™ to alert the user of potential problems during the pH calibration process. Alerts displayed during calibration include "Electrode Dirty/Broken" and "Buffer Contaminated." The overall probe condition based on the offset and slope characteristic of the electrode is displayed as a percentage after calibration is complete. The calibration data including

date, time, buffers used, offset, and slope can be accessed at any time along with the current measurement by selecting the Good Laboratory Practice (GLP) display option.

Three selectable logging modes are available: automatic, manual, and AutoHold logging. Up to 100,000 data points can be recorded in 100 lots with 50,000 records max/lot and exported to a computer for data review and storage.



## Customizable User Interface

The user interface of the HI5221 allows the user to show measurements in various modes: basic measurement with or without GLP information, real-time graphing, and logging data. Calibration stability criteria can be adjusted to fast, moderate, or accurate. Programmable alarm limits can be set to inside or outside allowable limits.

## Color Graphic LCD

The HI5221 features a color graphic LCD with on-screen help, graphic, and custom color configurations. The display allows for real-time graphing and the use of virtual keys provide for an intuitive user interface.

## Capacitive Touch

The HI5221 features sensitive capacitive touch buttons for accurate keystrokes when navigating menus and screens. There are four dedicated keys that are used for routine operations including calibration and switching measurement modes and four virtual keys that change based upon use. The capacitive touch technology ensures the buttons never get clogged with sample residue.

## Choice of Calibration

Automatic buffer recognition, semiautomatic, and manual pH calibration options are available for calibrating up to five points, from a selection of eight standard buffers and up to five custom buffers.

## GLP Data

HI5221 includes a GLP feature that allows users to view calibration data and calibration expiration information at the touch of a key. Calibration data include date, time, buffers /standards used for calibration, and slope characteristics. The offset is also displayed for pH electrodes.

## CAL Check™

CAL Check alerts users to potential problems during the calibration of the pH electrode. Alerts include "Electrode Dirty/Broken," "Buffer Contaminated," electrode response time, and the overall probe condition as a percentage that is based on the offset and slope characteristics.

## Data Logging

Three selectable logging modes are available on the HI5221: automatic, manual, and AutoHold logging. Automatic and manual logs up to 100 lots with 50,000 records max/lot, with up to 100,000 total data points. Automatic logging features the option to save data according to sampling period and interval.

## Data Transfer

Data can be transferred to a PC with USB cable and HI92000 software (both sold separately).

## Contextual Help

Contextual help is always available through a dedicated "HELP" key. Clear tutorial messages and directions are available on-screen to quickly and easily guide users through setup and calibration. The help information displayed is relative to the setting/option being viewed.

Specifications	HI5221	
pH	Range	-2.0 to 20.0 pH; -2.00 to 20.00; -2.000 to 20.000 pH
	Resolution	0.1 pH; 0.01 pH; 0.001 pH
	Accuracy	±0.1 pH; ±0.01 pH; ±0.002 pH ±1 LSD
	Calibration	automatic, up to five point calibration, eight standard buffers available (1.68, 3.00, 4.01, 6.86, 7.01, 9.18, 10.01, 12.45), and five custom buffers
	Temperature Compensation	automatic or manual from -20.0 to 120.0°C/-4.0 to 248.0°F/253.15 to 393.15K
mV	Range	±2000 mV
	Resolution	0.1 mV
	Accuracy	±0.2 mV ±1 LSD
	Relative mV Offset Range	±2000 mV
Temperature*	Range	-20.0 to 120°C; -4.0 to 248.0°F; 253.15 to 393.15K
	Resolution	0.1°C; 0.1°F; 0.1K
	Accuracy	±0.2°C; ±0.4°F; ±0.2K
Additional Specifications	pH Electrode	HI1131B glass body pH electrode with BNC connector and 1 m (3.3') cable (included)
	Temperature Probe	HI7662-W stainless steel temperature probe with 1 m (3.3') cable (included)
	Input Channel(s)	1 pH/ORP
	GLP	calibration points, calibration time stamp, probe offset, slope, date, time and buffers/standards used
	Logging	<b>record</b> : Up to 100 lots, 50,000 records max/lot / maximum 100,000 data points/channel; <b>interval</b> : 14 selectable between 1 second and 180 minutes; <b>type</b> : automatic, manual, AutoHOLD;
	Display	color graphic LCD 240x340 pixels
	PC Connection	USB
	Power Supply	12 VDC adapter (included)
	Environment	0 to 50°C (32 to 122°F; 273 to 323K) RH max 95% non-condensing
	Dimensions	160 x 231 x 94 mm (6.3 x 9.1 x 3.7")
	Weight	1.2 kg (2.64 lbs.)
Ordering Information	<b>HI5221-01</b> (115V) and <b>HI5221-02</b> (230V) are supplied with HI1131B pH electrode, HI7662-W temperature probe, pH 4.01 buffer solution sachet (2), pH 7.01 buffer solution sachet (2), HI700601 electrode cleaning solution sachet (2), HI7082 3.5M KCl electrolyte solution (30 mL), HI76404W electrode holder, 12 VDC adapter, capillary dropper pipette, quality certificate, quick start guide, and instruction manual. <b>HI5221-03</b> includes the above without electrode.	

(\*) Reduced to actual probe limits

## pH Benchtop Meter

with Built-in Printer

The HI122 is a professional pH/mV and temperature benchtop meter with a built-in printer. The built-in impact printer incorporated into the HI122 allows measurement information to be printed while in various modes. The meter comes with Hanna's HI1131P glass pH electrode and the temperature probe HI7662-T to allow for automatic temperature compensation. The HI122 also allows for ORP measurements when used with the HI3131B ORP electrode (supplied separately).



### CAL Check™

Hanna's exclusive CAL Check diagnostics system ensures accurate pH readings every time by alerting users to potential problems during the calibration process. The CAL Check system eliminates erroneous readings due to dirty or faulty pH electrodes or contaminated pH buffer solutions during calibration. After the guided calibration process, the probe condition is evaluated and an alert is displayed informing the user of the overall pH electrode status.

### Automatic Calibration

pH calibration can be performed with up to five points with seven standard buffers and two custom buffers.

### HI1131P pH Electrode

The HI122 is supplied with the HI1131P glass body, double junction, refillable pH electrode with an indicating sensor made of High Temperature (HT) glass. The double junction and HT glass design allows the HI1131P to be used in a wide variety of applications ranging from samples with metals and Tris buffer to samples at elevated temperatures.

### Temperature Compensation

Temperature for pH measurements can be compensated for automatically (ATC) or manually (MTC) from -20.0 to 120.0°C with the use of the supplied HI7662-T temperature probe.

### GLP Data

The calibration data for each channel including date, time, standards used, offset, and slope can be accessed at any time through the HI122 menu.

### Data Logging

The log-on-demand feature accepts the recording of 50 samples. Interval logging allows up to 1000 data points to be recorded and allows the user to specify time intervals from 5 seconds to 180 minutes.

### Data Transfer

With a built-in logging function, measurements are stored in non-volatile memory, and can be transferred to a PC through the RS232 port.



### Built-in Impact Printer

The built-in impact printer incorporated into the HI122 uses regular paper that does not fade with time. The information related to measurements being taken can be printed while in measurement mode, GLP, or Setup mode. This meter also allows users to print detailed information in four languages for specific help screens and instrument set-up.

### Secondary keypad

Specifications	HI122	
pH	Range	-2.00 to 16.00 pH; -2.000 to 16.000 pH
	Resolution	0.01 pH; 0.001 pH
	Accuracy (@25°C)	±0.01 pH; ±0.002 pH
	Calibration	automatic, up to five point calibration standard with seven buffers (1.68, 4.01, 6.86, 7.01, 9.18, 10.01, 12.45) and two custom buffers
Temperature Compensation	automatic or manual from -20.0 to 120°C (-4.0 to 248.0°F)	
mV	Range	±999.9; ±2000 mV
	Resolution	0.1 mV; 1 mV
	Accuracy @25°C	±0.2 mV (±699.9 mV); ±0.5 mV (±999.9 mV); ±1 mV (±2000 mV)
	Relative mV Offset Range	±2000 mV
Temperature	Range	-20.0 to 120.0°C (-4.0 to 248.0°F)
	Resolution	0.1°C (0.1°F)
	Accuracy @25°C	±0.4°C (±0.7°F)
Additional Specifications	pH Electrode	HI1131P glass body pH electrode with BNC + pin connectors and 1 m (3.3') cable (included)
	Temperature Probe	HI7662-T temperature probe with 1 m (3.3') cable (included)
	Log-on-demand	50 samples (25 per channel)
	Interval Logging	5 second to 180 minutes, 1000 samples (500 per channel)
	Input Impedance	10 <sup>12</sup> Ohm
	PC Connection	RS232 serial port, opto-isolated
	Printer	built-in dot matrix printer, with 44 mm plain paper
	Power Supply	12 VDC adapter (included)
	Environment	0 to 50°C (32 to 122°F); RH max 95% non-condensing
	Dimensions	280 x 203 x 84 mm (11.0 x 8.0 x 3.3")
Weight	1.9 kg (4.2 lbs.)	
Ordering Information	<b>HI122-01</b> (115V) and <b>HI122-02</b> (230V) are supplied with HI1131P pH electrode, HI7662-T temperature probe, HI70004 pH 4.01 buffer solution sachet, HI70007 pH 7.01 buffer solution sachet, HI7082 3.5M KCL electrolyte solution (30 mL), (5) paper rolls, 12 VDC adapter, and instructions.	
Accessories	<b>HI710032</b> Paper rolls (10)	
	<b>HI710033</b> ink cartridge	



## The world's most innovative pH, EC, and DO meter

edge's groundbreaking design is the culmination of Hanna's vision, design capabilities, integrated production, and world class R&D. The edge is rich in features to accommodate the needs of a vast amount of customers. For those that prefer very simplistic operation there is a basic mode operation with simplified menu and options while for those who require advanced features there is the full featured standard operating mode. edge is available as a pH, conductivity, or dissolved oxygen kit and any edge kit can be upgraded with additional probes to measure pH, conductivity, and dissolved oxygen.

# edge® technical features

## Rechargeable Battery

edge has a built in rechargeable battery that is charged when the meter is plugged in into the benchtop or wall mount cradle. The battery can also be recharged through the micro USB port with either a computer or the power supply.



## Two USB ports

edge includes one standard USB for exporting data to a flash drive, and one micro USB port for exporting files to your computer as well as for charging when the cradle is not available.



## Clear, full text readout

edge features clear, full text guides displayed on the bottom of the screen. There is no need to decipher scrambled abbreviations or symbols; these helpful messages guide you through every process quickly and easily.



## Data logging

edge allows you to store up to 1000 log records of data. Data sets include readings, GLP data, date, and time.



## GLP

Data of the last calibration you perform is stored in the sensor including the date, time, and buffers used. When the sensor is connected to edge, GLP data is automatically transferred.

## Two Operating Modes

edge can be used in Extended or Basic Operating Modes. Extended Mode enables all edge features while Basic Mode reduces features—ideal for routine measurements by displaying a simplified screen and features.



## CAL Check™

Hanna's exclusive CAL Check feature analyzes the pH electrode response in the pH buffers during the calibration process to alert the user of potential problems such as a contaminated buffer or dirty electrode. After calibration, indicators for probe condition are displayed on the measurement screen. The probe condition is based on offset and slope characteristics of the pH electrode.

## Sensor Check™ (pH only)

When used with Hanna's electrodes equipped with a matching pin, edge constantly checks the impedance of the pH measuring electrode to notify you in real time in the event of glass breakage. During calibration, Sensor Check checks the state of the junction. The reference junction is also evaluated and reported on the display.

## ORP Measurement

edge measures ORP with edge compatible ORP probes.

# edge design features



## Capacitive touch keypad

edge features sensitive capacitive touch buttons for accurate keystrokes when navigating edge's menus and screens. Since they are part of the screen, the buttons can never get clogged with sample residue.



## Easy to read LCD

edge features a 5.5" (14 cm) LCD display that you can clearly view from over 5 m (16.4'). The large display, with its wide 150° viewing angle, provides one of the easiest to read LCDs in the industry.



## Zero footprint

Using the wall mount cradle (included), edge can be placed on a wall, leaving zero footprint on the benchtop space. The cradle has a built-in connector to power and charge the batteries.



## Hybrid meters that can be used in portable, wall-mount, and benchtop configurations

The versatile design of edge® enables it to be used as a portable, wall-mount, or benchtop meter. edge simplifies measurement, configuration, calibration, diagnostics, logging, and transferring data directly to a computer or USB drive.



### Portable field unit

edge is ideal for field use due to its light weight, large screen, and thin design. It can easily be slipped into a backpack or messenger bag. The battery life lasts up to 8 hours when used as a portable device.



### Wall-mount cradle

The included wall-mount cradle makes it easy to conserve space on the benchtop while also charging the edge with the AC adapter. The cradle is ideal for continuous monitoring applications.



### Electrode holder with built-in cradle

The electrode holder features a swivel, adjustable arm with a built-in cradle to hold the edge securely in place at the optimum viewing angle.



## Digital electrodes

edge® measures pH, conductivity and dissolved oxygen through its unique digital electrodes. These digital electrodes are auto-recognized, providing sensor type, calibration data, and a serial number when connected to edge by an easy to plug-in 3.5 mm connector.

- Simply connect each probe via the 3.5 mm jack, Digital Smart Electrodes are automatically recognized

- Resolution selectable from 0.01 and 0.001 pH
- Range -2.000 to 16.000 pH
- Accuracy  $\pm 0.002$  pH for 0.001 pH resolution;  $\pm 0.01$  for 0.01 resolution
- Data logging
  - Manual log-on-demand
  - Manual log-on-stability
  - Interval logging
- Temperature readout ( $^{\circ}\text{C}$  or  $^{\circ}\text{F}$ )
- Automatic Temperature Compensation (ATC)
- CAL Check™ Indicators:
  - Probe condition
  - Response time
  - Check buffer
  - Clean electrode
- Sensor Check™ Indicators:
  - Broken electrode
  - Clogged junction
- GLP data
  - Records date, time, offset, slope, and buffers used during calibration
- Five-point calibration
  - A choice of seven pre-programmed buffers plus two selectable custom buffers
- Calibration tag on screen
  - Identifies buffers used for current calibration
- Calibration expiration warning



### Sleek design

Incredibly thin and lightweight, edge measures just 1/2" (12 mm) thick and weighs just 8.8 ounces (250 g).

All edge compatible pH, EC, and dissolved oxygen digital probes are interchangeable with edge.

Specifications	HI2020	
pH	Range*	-2.00 to 16.00 pH; -2.000 to 16.000 pH <sup>†</sup>
	Resolution	0.01 pH; 0.001 pH <sup>†</sup>
	Accuracy (@25°C/77°F)	$\pm 0.01$ pH; $\pm 0.002$ pH <sup>†</sup>
	Calibration	automatic, up to three points (five points <sup>†</sup> ) calibration, 5 standard (7 standard <sup>†</sup> ) buffers available (1.68 <sup>†</sup> , 4.01 or 3.00, 6.86, 7.01, 9.18, 10.01, 12.45 <sup>†</sup> ) and two custom buffers <sup>†</sup>
	Temperature Compensation*	automatic, -5.0 to 100.0°C (23.0 to 212.0°F) (using the built-in temperature sensor)
mV pH	Electrode Diagnostics	standard mode: probe condition, response time and out of calibration range
	Range	$\pm 1000$ mV
	Resolution	0.1 mV
Temperature	Accuracy (@25°C/77°F)	$\pm 0.2$ mV
	Range*	-20.0 to 120.0°C; -4.0 to 248.0°F
	Resolution	0.1°C; 0.1°F
Additional Specifications	Accuracy	$\pm 0.5^{\circ}\text{C}$ ; $\pm 0.9^{\circ}\text{F}$
	Probe (included in pH kit)	HI11310 digital glass body pH electrode with 3.5 mm (1/8") connector and 1 m (3.3') cable
	Logging	up to 1000 <sup>†</sup> (400 for basic mode) records organized in: manual log-on-demand (max. 200 logs), manual log-on-stability (max. 200 logs), interval logging <sup>†</sup> (max. 600 samples; 100 lots)
	Connectivity	1 USB port for storage; 1 micro USB port for charging and PC connectivity
	Environment	0 to 50°C (32 to 122°F); RH max 95% non-condensing
Ordering Information	Power Supply	5 VDC adapter (included)
	Dimensions / Weight	202 x 140 x 12 mm (7.9" x 5.5" x 0.5") / 250 g (8.82 oz.)
		<b>HI2020-01</b> (USA plug) and <b>HI2020-02</b> (European plug) pH kit includes: HI11310 glass body, refillable pH electrode, pH 4 buffer solution sachets (4), pH 7 buffer solution sachets (2), pH 10 buffer solution sachets (2), and electrode cleaning solution sachets (2), benchtop docking station with electrode holder, wall-mount cradle, USB cable, 5 VDC power adapter, quality certificates, and instruction manual. <b>HI2020-03</b> includes the above without electrode. All edge compatible pH, EC and DO digital probes are interchangeable with HI2020 and can be ordered separately.

\* limits will be reduced to actual probe limits  
† standard mode only



## edge<sup>®</sup>pH—Innovation dedicated to a single parameter

edge pH's groundbreaking design is the culmination of Hanna's vision, design capabilities, integrated production, and world class R&D. edge pH is a single meter that can measure pH and ORP and is incredibly easy to use.

- Resolution selectable from 0.01 and 0.001 pH
- Range -2.000 to 16.000 pH
- Accuracy  $\pm 0.002$  pH for 0.001 pH resolution;  $\pm 0.01$  for 0.01 resolution
- Data logging
  - Manual log-on-demand
  - Manual log-on-stability
  - Interval logging
- Temperature readout ( $^{\circ}\text{C}$  or  $^{\circ}\text{F}$ )
- Automatic Temperature Compensation (ATC)
- CAL Check<sup>™</sup> Indicators:
  - Probe condition
  - Response time
  - Check buffer
  - Clean electrode
- Sensor Check<sup>™</sup> Indicators:
  - Broken electrode
  - Clogged junction
- GLP data
  - Records date, time, offset, slope, and buffers used during calibration
- Five-point calibration
  - A choice of seven pre-programmed buffers plus two selectable custom buffers
- Calibration tag on screen
  - Identifies buffers used for current calibration
- Calibration expiration warning



## edge®pH technical features

### Rechargeable Battery

edge pH has a built in rechargeable battery that is charged when the meter is plugged into benchtop or wall mount cradle. The battery can also be recharged through the micro USB port from a computer or the power supply.



### Two USB ports

edge pH includes one standard USB for exporting data to a flash drive, and one micro USB port for exporting files to your computer as well as for charging when the cradle is not available.



### Clear, full text readout

edge pH features clear, full text guides displayed on the bottom of the screen. There is no need to decipher scrambled abbreviations or symbols; these helpful messages guide you through every process quickly and easily.



### Data logging

edge pH allows you to store up to 1000 log records of data. Data sets include readings, GLP data, date, and time.



### GLP

Data of the last calibration you perform is stored in the sensor including the date, time, and buffers used. When the sensor is connected to edge pH, GLP data is automatically transferred.

### Two Operating Modes

edge pH can be used in Extended or Basic Operating Modes. Extended Mode enables all edge features while Basic Mode reduces features—ideal for routine measurements by displaying a simplified screen and features.



### CAL Check™

Hanna's exclusive CAL Check feature analyzes the pH electrode response in the pH buffers during the calibration process to alert the user of potential problems such as a contaminated buffer or dirty electrode. After calibration, indicators for probe condition are displayed on the measurement screen. The probe condition is based on offset and slope characteristics of the pH electrode.

### Sensor Check™

When used with Hanna's electrodes equipped with a matching pin, edge constantly checks the impedance of the pH measuring electrode to notify you in real time in the event of glass breakage. During calibration, Sensor Check checks the state of the junction. The reference junction is also evaluated and reported on the display.

### ORP Measurement

edge pH measures ORP with edge compatible ORP probes.

## edge pH design features



### Capacitive touch keypad

edge pH features sensitive capacitive touch buttons for accurate keystrokes when navigating edge's menus and screens. Since they are part of the screen, the buttons can never get clogged with sample residue.



### Easy to read LCD

edge pH features a 5.5" (14 cm) LCD display that you can clearly view from over 5 m (16.4'). The large display, with its wide 150° viewing angle, provides one of the easiest to read LCDs in the industry.



### Zero footprint

Using the wall mount cradle (included), edge pH can be placed on a wall, leaving zero footprint on the benchtop space. The cradle has a built-in connector to power and charge the batteries.



## A hybrid meter that can be used in portable, wall-mount, and benchtop configurations

The versatile design of edge®pH enables it to be used as a portable, wall-mount, or benchtop meter. edge pH simplifies measurement, configuration, calibration, diagnostics, logging and transferring data directly to a computer or USB drive.



### Portable field unit

edge pH is ideal for field use due to its light weight, large screen, and thin design. It can easily be slipped into a backpack or messenger bag. The battery life lasts up to 8 hours when used as a portable device.



### Wall-mount cradle

The included wall-mount cradle makes it easy to conserve space on the benchtop while also charging edge pH with the AC adapter. The cradle is ideal for continuous monitoring applications.



### Electrode holder with built-in cradle

The electrode holder features a swivel, adjustable arm with a built-in cradle to hold edge pH securely in place at the optimum viewing angle.



## 3.5 mm probe input

Plugging an electrode in has never been simpler; no alignments or broken pins, simply connect the 3.5 mm plug and begin. Digital electrodes are automatically recognized.

## Sleek design

Incredibly thin and lightweight, edge®pH measures just 1/2" (12 mm) thick and weighs just 8.8 ounces (250 g).



## Specifications

pH	Range*	-2.00 to 16.00 pH; -2.000 to 16.000 pH†
	Resolution	0.01 pH; 0.001 pH†
	Accuracy (@25°C/77°F)	±0.01 pH; ±0.002 pH†
	Calibration	automatic, up to three points (five points <sup>†</sup> ) calibration, 5 standard (7 standard <sup>†</sup> ) buffers available (1.68 <sup>†</sup> , 4.01 or 3.00, 6.86, 7.01, 9.18, 10.01, 12.45 <sup>†</sup> ) and two custom buffers <sup>†</sup>
	Temperature Compensation*	automatic, -5.0 to 100.0°C (23.0 to 212.0°F) (using built-in temperature sensor)
mV pH	Electrode Diagnostics	standard mode: probe condition, response time and out of calibration range
	Range	±1000 mV
	Resolution	0.1 mV
ORP	Accuracy (@25°C/77°F)	±0.2 mV
	Range	±2000 mV
	Resolution	0.1 mV
	Accuracy (@25°C/77°F)	±0.2 mV (±999.9 mV); ±1 mV (±2000 mV)
Temperature	Calibration	one-point calibration
	Range*	-20.0 to 120.0°C; -4.0 to 248.0°F
	Resolution	0.1°C; 0.1°F
Additional Specifications	Accuracy	±0.5°C; ±0.9°F
	Probe	HI11310 digital glass body pH electrode with 3.5 mm (1/8") connector and 1 m (3.3') cable
	Logging	up to 1000 <sup>†</sup> (400 for basic mode) records organized in: manual log-on-demand (max. 200 logs), manual log-on-stability (max. 200 logs), interval logging <sup>†</sup> (max. 600 samples; 100 lots)
	Connectivity	1 USB port for storage; 1 micro USB port for charging and PC connectivity
	Environment	0 to 50°C (32 to 122°F); RH max 95% non-condensing
	Power Supply	5 VDC adapter (included)
	Dimensions	202 x 140 x 12 mm (7.9" x 5.5" x 0.5")
Weight	250 g (8.82 oz.)	
Ordering Information	<p><b>HI2002-01</b> (USA plug) and <b>HI2002-02</b> (European plug) edge pH includes: HI11310 glass body, refillable pH electrode, pH 4 buffer solution sachets (4), pH 7 buffer solution sachets (2), pH 10 buffer solution sachets (2), electrode cleaning solution sachets (2), benchtop docking station with electrode holder, wall-mount cradle, USB cable, 5 VDC power adapter, quality certificates, and instruction manual.</p> <p><b>HI2002-03</b> includes the above without electrode.</p>	

\* limits will be reduced to actual probe limits  
<sup>†</sup> standard mode only

## First pH meter in the world with a Bluetooth® Smart pH electrode

Free yourself from wires when performing pH measurements. Hanna Instruments is proud to introduce edge<sup>blu</sup>, a pH meter that uses HALO® pH electrodes with Bluetooth® Smart technology (Bluetooth 4.0). Bluetooth® Smart technology is energy efficient, allowing for low power consumption to maximize the life of the replaceable battery used in the pH electrode.

HALO electrodes can also connect to a compatible smart phone or tablet running the Hanna Lab App.

pH

edge<sup>blu</sup>

# edge®blu technical features

## Rechargeable Battery

edge blu has a built in rechargeable battery that is charged when the meter plugged into the benchtop or wall mounted cradle. The battery can also be recharged through the micro USB port connected to a computer or directly to a power supply.



## Two USB ports

edge blu includes one standard USB for exporting data to a flash drive and one micro USB port for exporting files to your computer as well as for charging when the cradle is not available.



## Data logging

Log-on-demand, log-on-stability, and interval logging modes are all available. Up to 200 data points can be logged on demand and an additional 200 data points for samples logged upon a stable reading. The logging interval is adjustable from 5 seconds to 180 minutes. Up to 600 records can be stored in a maximum of 100 interval lots. Logging modes can be started from the meter or by simply pressing the button on the HALO pH probe.

## GLP

Data of the last calibration you perform is stored in the sensor including the date, time, and buffers used. When the sensor is connected to edge blu, GLP data is automatically transferred.

The Bluetooth® word mark and logos are registered trademarks owned by Bluetooth SIG, Inc.



## CAL Check™

Hanna's exclusive CAL Check feature analyzes the pH electrode response in the pH buffers during the calibration process to alert the user of potential problems such as a contaminated buffer or dirty electrode. After calibration, indicators for probe condition are displayed on the measurement screen. The probe condition is based on offset and slope characteristics of the pH electrode.



## Bluetooth Smart Technology

HI11102 HALO® pH electrode use Bluetooth® Smart Technology (Bluetooth 4.0). This technology offers low power consumption allowing for a long 500 hour battery life. The range of the Bluetooth connection is 10 m (33') between the probe and receiving device.



## Auto-detection

At a push of the button, the HALO pH electrode enters discovery mode and will be detected by edge blu. Once connected, the serial number, calibration information including date, time and buffers used, and the electrode specifications will be loaded into the meter. Having this information stored in the electrode allows for hot swapping to other pH electrodes without recalibrating. The details of the electrode and calibration information are stored with any logged readings.

# edge blu design features



## Capacitive touch keypad

edge blu features sensitive capacitive touch buttons for accurate keystrokes when navigating edge's menus and screens. Since they are part of the screen, the buttons can never get clogged with sample residue.



## Easy to read LCD

edge blu features a 5.5" (14 cm) LCD display that you can clearly view from over 5 m (16.4') away. The large display, with its wide 150° viewing angle, provides one of the easiest to read LCDs in the industry.



## Zero footprint

Using the wall mount cradle (included), edge blu can be placed on a wall, leaving zero footprint on the benchtop space. The cradle has a built-in connector to power the meter and charge the batteries.



## A hybrid meter that can be used in portable, wall-mount, and benchtop configurations

The versatile design of edge®blu enables it to be used as a portable, wall-mount, or benchtop meter. edge blu simplifies measurement, wirelessly using compatible HALO® pH electrodes with Bluetooth® Smart technology.



### Portable field unit

edge blu is ideal for field use due to its light weight, large screen, and thin design. It can easily be slipped into a backpack or messenger bag. The battery life lasts up to 8 hours when used as a portable device.



### Wall-mount cradle

The included wall-mount cradle makes it easy to conserve space on the benchtop while also charging edge blu with the AC adapter. The cradle is ideal for continuous monitoring applications.



### Electrode holder with built-in cradle

The electrode holder features a swivel, adjustable arm with a built-in cradle to hold edge blu securely in place at the optimum viewing angle.



HI181 magnetic stirrer and beaker not included.



4.0

Bluetooth®  
Smart

0

footprint

0.5

inch thick  
(12.7 mm)

8.8

oz. weight  
(250 g)

8

hours battery  
life

5.5

inch display  
(14 cm)

2

USB ports

## edge blu additional features

- Resolution selectable from 0.01 and 0.001 pH
- Range -2.000 to 16.000 pH
- Accuracy  $\pm 0.002$  pH for 0.001 pH resolution;  $\pm 0.01$  for 0.01 resolution
- Data logging
  - Manual log-on-demand
  - Manual log-on-stability
  - Interval logging
- Temperature readout (°C or °F)
- Automatic Temperature Compensation (ATC)
- CAL Check™ Indicators:
  - Probe condition
  - Response time
  - Check buffer
  - Clean electrode
- GLP data
  - Records date, time, offset, slope, and buffers used during calibration
- Five-point calibration
  - A choice of seven pre-programmed buffers plus two custom buffers
- Calibration tag on screen
  - Identifies buffers used for current calibration
- Calibration expiration warning
- Basic mode
  - edge®blu Basic Mode is ideal for routine measurements by displaying a simplified screen and features
- Standby mode
  - HALO® can be switched between standby and measurement mode by edge blu. When measurement is resumed, HALO is automatically recognized. Standby mode is ideal for applications such as aquariums when only periodic measurements are needed in the same sample.

The Bluetooth® word mark and logos are registered trademarks owned by Bluetooth SIG, Inc.



## HI11102 HALO pH electrode with Bluetooth® Smart technology

edge blu® is supplied with the HI11102 HALO® professional pH probe with Bluetooth® Smart technology (Bluetooth 4.0). This probe is compatible with the edge blu and the Hanna Lab App<sup>1</sup>.

The HI11102 HALO pH electrode is a glass body, gel filled, double junction pH electrode that has an indicating probe made with general purpose glass. The glass body is resistant to many chemicals and easy to clean. Being gel filled reduces maintenance since there are no fill solutions to add. The double junction design is suitable for a variety of solutions that can contain substances such as heavy metals or Tris buffer that will cause the silver chloride (AgCl) found in a single junction probe to precipitate and clog the junction.

- Gel filled glass pH electrode
- Double junction reference design
- Integrated temperature sensor
  - Ensures calibration and measurement is automatically temperature compensated, thus eliminating error
- Wide pH (0 to 12) and temperature (-5 to 80°C) range
- Clear the clutter
  - Data is wirelessly transmitted to the edge blu or compatible smart phone or tablet running the Hanna Lab App via Bluetooth® Smart technology<sup>1</sup>. HI11102 HALO provides up to 500 hours of battery life
- Calibration is stored
  - HI11102 HALO stores calibration information; no additional calibration is needed when switching to another edge blu or iPad
- Battery condition
  - The measurement screen of the edge blu and Hanna Lab App displays the name, battery life and condition of the HI11102 HALO probe

## Hanna Lab App

pH Meter Application for use with HALO



The Hanna Lab App turns compatible smart phone or tablet into a full-featured pH meter when used with a HALO pH probe via Bluetooth® Smart technology. Functions include calibration, measurement, data logging, graphing, and data sharing. Measurement and logging of pH and temperature at one second intervals start as soon as the probe is connected. Measurements can be displayed alone on the display, with tabulated data or as a graph. The graph can be panned and zoomed with pinch-to-zoom technology for enhanced viewing.

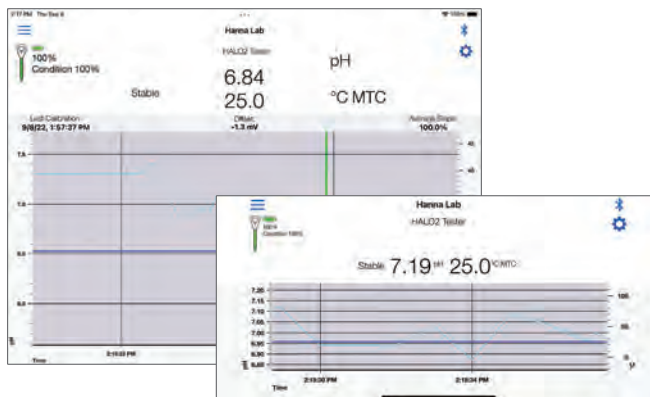

- Connects via Bluetooth® 4.0
- Calibration reminder
- Real-time data
  - Displays updated pH and temperature updated every second
- Measurement alarms
  - Alerts users if the measurement threshold is exceeded
- Basic GLP
  - Displays date and time of current calibration along with probe offset and average slope
- Full GLP
  - Displays date and time of current calibration, probe offset, and average slope along with calibrated buffers, mV values, temperature, and slopes between each buffer
- Fluid, dynamic graphing
  - Measurements can be displayed with tabulated data or as a graph
- One button sample tagging
- Data-logging with custom annotations
  - Data is automatically saved every hour
  - Saved log files may be annotated with measurement specific information
- Four ways to save and share data:
  - All data since last auto save
  - Annotations only
  - All data within a timed interval
  - Annotations within a timed interval
- Share data via email in CSV format
- Help and tutorials

The Bluetooth® word mark and logos are registered trademarks owned by Bluetooth SIG, Inc.

<sup>1</sup> HALO electrodes can only be used with one compatible device at a time.



Specifications	edge®blu*	
pH	Range <sup>2</sup>	-2.00 to 16.00 pH; -2.000 to 16.000 pH <sup>†</sup>
	Resolution	0.01 pH; 0.001 pH <sup>†</sup>
	Accuracy (@25°C/77°F)	±0.01 pH; ±0.002 pH <sup>†</sup>
	Calibration	Basic mode: Automatic, up to 3 points calibration 5 standard buffer Standard mode: Automatic up to 5 points calibration 7 standard buffers (1.68, 4.01 or 3.00, 6.86, 7.01, 9.18, 10.01, 12.45) and 2 custom buffers <sup>†</sup>
	Temperature Compensation <sup>2</sup>	automatic, -5.0 to 100.0°C (23.0 to 212.0°F) (using built-in temperature sensor)
	Electrode Diagnostics	standard mode: probe condition, response time, and out of calibration range
mV pH	Range	±1000 mV
	Resolution	0.1 mV
	Accuracy (@25°C/77°F)	±0.2 mV
Temperature	Range <sup>2</sup>	-20.0 to 120.0°C; -4.0 to 248.0°F
	Resolution	0.1°C; 0.1°F
	Accuracy	±0.5°C; ±0.9°F
Additional Specifications	Probe	HI11102 HALO® glass body pH electrode with Bluetooth® Smart technology
	Logging	up to 1000 <sup>†</sup> (400 for basic mode) records organized in: manual log-on-demand (max. 200 logs), manual log-on-stability (max. 200 logs), interval logging <sup>†</sup> (max. 600 samples; 100 lots)
	Connectivity	1 USB port for storage; 1 micro USB port for charging and PC connectivity
	Environment	0 to 50°C (32 to 122°F); RH max 95% non-condensing
	Power Supply	5 VDC adapter (included)
	Dimensions	202 x 140 x 12 mm (7.9" x 5.5" x 0.5")
	Weight	250 g (8.82 oz.)
Ordering Information	<b>HI2202-01</b> (USA plug) and <b>HI2202-02</b> (European plug) edge blu includes: HI11102 HALO pH electrode with Bluetooth® Smart technology, pH 4 buffer solution sachets (4), pH 7 buffer solution sachets (2), pH 10 buffer solution sachets (2), electrode cleaning solution sachets (2), battery for HALO, benchtop docking station with electrode holder, wall-mount cradle, USB cable, 5 VDC power adapter, quality certificates, and instruction manual.	

HALO Specifications	HI11102 HALO (included)
Reference	double, Ag/AgCl
Junction	ceramic
Electrolyte	gel
Range	0.00 to 12.00 pH ±420 mV
Bulb Shape	spheric
Outer Diameter (glass)	12 mm (glass)
Overall Length	183 mm
Solution Temperature	-5.0 to 80.0°C (23.0 to 176.0°F)
Body Material	glass
Environment	0.0 to 50.0°C (32.0 to 122.0°F), electronic module is not waterproof
Temperature Sensor	integrated
Connection	Bluetooth® Smart (Bluetooth® 4.0), 10 m (33') range
Battery Type / Life	CR2032 3V lithium ion / approximately 500 hours

#### Hanna Lab App Specifications\*

Range <sup>2</sup>	-2.000 to 16.000 pH ±800 mV -20.0 to 120.0°C (-4.0 to 248.0°F)
Resolution	0.1; 0.01; 0.001 pH 1; 0.1 mV 0.1°C (0.1°F)
Accuracy (@25°C/77°F)	±0.005 pH ±0.3 mV ±0.5°C (±1.0°F)
Calibration Points	up to five-point calibration with seven standard buffers (1.68, 3.00 or 4.01, 6.86, 7.01, 9.18, 10.01, 12.45 pH)
Temperature Compensation <sup>2</sup>	automatic from -5.0 to 100.0°C; 23.0 to 212.0°F
Compatibility/System Requirements	see <a href="http://www.hannainst.com">www.hannainst.com</a> for latest compatibility requirements

Download Information



App Store is a service mark of Apple Inc., Google Play and the Google Play logo are trademarks of Google LLC. The Bluetooth® word mark and logos are registered trademarks owned by Bluetooth SIG, Inc.

<sup>2</sup> Limits will be reduced to actual probe/sensor limits.  
\* HALO required for measurement use.  
<sup>†</sup> Standard mode only

# HALO2

Wireless pH Testers

pH

HALO2



Take the complexity out of testing

HALO2 Wireless pH Meter with Bluetooth® Smart technology (Bluetooth® 4.0) is updated with a dual-level LCD and temperature measurement for automatic temperature compensation. HALO2 pH probes can be used virtually anywhere: in the field, laboratory, or classroom. Their versatility and ease of use will revolutionize the way pH is measured.

15 Application Specific Testers

IP65  
waterproof

Bluetooth®



Hanna Lab App  
Compatible



### Bluetooth Versatility

Connect to the Hanna Lab App via Bluetooth® wireless technology (10 m range (33')). The Bluetooth icon on the HAL02 LCD indicates the probe is active and transmitting.



### Easy to Replace Battery

HAL02's CR2032 lithium ion battery is easily replaced and lasts for approximately 1,000 hours.



### One Button Sample Tagging

Pressing the button on the HAL02 pH probe or the probe icon in the Hanna Lab App will tag sample data for easy reference.



### Easy Calibration

HAL02 can be placed right into our calibration buffer sachets for easy calibration. Using a Hanna calibration sachet ensures your buffer is always fresh.

HI9810402

# HALO2



Hanna Lab App  
Compatible

The Hanna Lab App is  
available on the App Store®  
and on Google Play.

## Wireless Refillable pH Tester for Lab

with built-in general purpose electrode

Accurate, and easy to use, HALO2 Wireless pH Tester for lab is ideal for measurements in samples that would be a challenge for standard design pH electrodes. The HI9810402 can be used as a stand-alone pH tester or can be connected to the Hanna Lab App.

- The integrated Bluetooth module allows the tester to be connected to a compatible smart device with the Hanna Lab App
- Compact, waterproof casing, and automatic pH calibration at up to three points, or five points when used with the Hanna Lab App
- Automatically temperature compensated readings

### HALO2 Specifications HI9810402

Range	pH	0.00 to 14.00 pH
	mV*	pH/mV conversion
	Temperature	-5.0 to 80.0 °C (23.0 to 176.0 °F)
Resolution	pH	0.01 or 0.1 pH
	mV*	0.1 or 1 mV
	Temperature	0.1 °C; 0.1 °F
Accuracy	pH	±0.02 pH
	Temperature	±0.5 °C; ±0.9 °F
Calibration	Up to three points or five points *	
	Automatic buffer recognition with Standard buffers Hanna (pH 1.68 *, 4.01, 7.01, 10.01, 12.45 *) or NIST (pH 1.68 *, 4.01, 6.86, 9.18, 12.45 *)	
Temperature compensation	Automatic (ATC) or Manual (MTC) *	
Electrode	Body material	Glass
	Glass	High Temperature (HT)
	Junction	Ceramic
	Reference cell	Double, Ag/AgCl
	Electrolyte	3.5M KCl (refillable)
	Tip / Shape	Spheric, Ø 9 mm (Ø 0.35")
	Outer diameter	12 mm (0.5")
Length	120 mm (4.7")	
Battery type	CR2032 3V Lithium	
Battery life	Approximately 1000 hours (500 hours with Bluetooth enabled)	
Environment	0 to 50 °C (32 to 122 °F)	
IP rating	IP65	
Dimensions / Weight	51 x 206 x 21 mm (2.0 x 8.1 x 0.8") / 60 g (2.1 oz.)	

### Ordering Information

**HI9810402** (HALO2) is supplied with a starter kit consisting of: pH 4.01 buffer solution sachet (2 pcs.), pH 7.01 buffer solution sachet (2 pcs.), Electrode cleaning solution sachet (2 pcs.), Electrode storage solution (dropper bottle), Electrolyte refill solution (30 mL), Pipette, 3V Lithium battery - CR2032, Instrument quality certificate and Instruction manual.

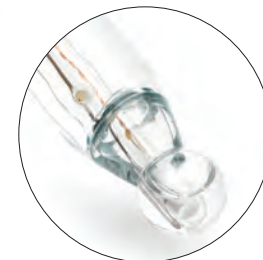
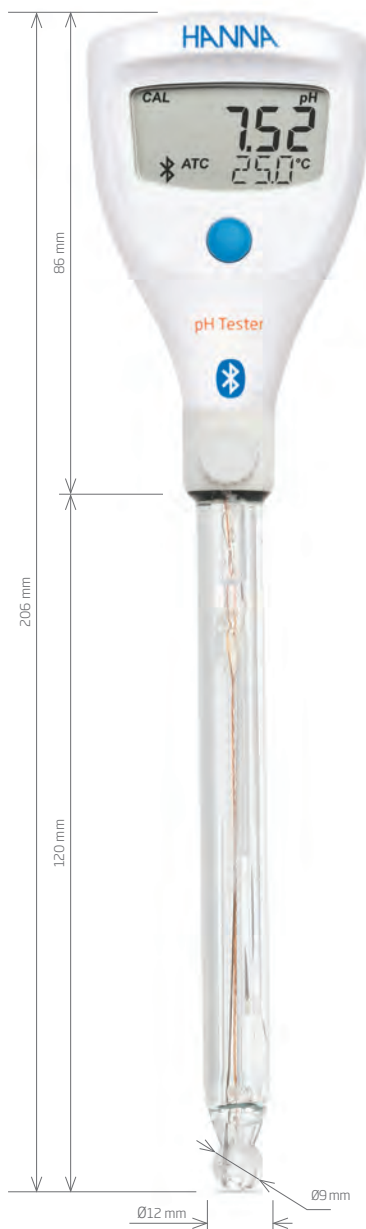

### Spherical tip

Provides maximum surface area for accurate measurements.

## Electrode Features

### Glass body

The HI9810402 features a non-porous glass body that is easy to clean and withstands harsh chemicals.

### Refillable

The double junction design presents a silver-free electrolyte solution interacting with the sample, making the electrode less susceptible to clogging and guaranteeing a fast response and stable reading.

### Built-in Temperature Sensor

Built-in temperature sensor at the tip of the pH electrode allows for rapid determination of the sample temperature and a high-accuracy temperature reading.

\* Available with Hanna Lab App  
Note: The tester can display measurements from -2.00 to 16.00 pH. Measurements outside of the pH range will flash.

App Store is a service mark of Apple Inc., Google Play and the Google Play logo are trademarks of Google LLC. The Bluetooth® word mark and logos are registered trademarks owned by Bluetooth SIG, Inc.

pH solutions begin on page 2.174, pH electrode cleaning solutions begin on page 2.188



### Spherical tip

Provides maximum surface area for accurate measurements.

HI9810412

# HALO2



Hanna Lab App  
Compatible

The Hanna Lab App is  
available on the App Store®  
and on Google Play.

## Wireless pH Tester for Lab

with built-in general purpose electrode

Accurate, and easy to use, HALO2 Wireless pH Tester for Lab is ideal for users that prefer a maintenance-free laboratory pH electrode. The HI9810412 can be used as a stand-alone pH tester or can be connected to the Hanna Lab App.

- The integrated Bluetooth module allows the tester to be connected to a compatible smart device with the Hanna Lab App
- Compact, waterproof casing, and automatic pH calibration at up to three points, or four points when used with the Hanna Lab App
- Automatically temperature compensated readings

HALO2 Specifications	HI9810412
Range	pH 0.00 to 12.00 pH
	mV* pH/mV conversion
	Temperature** -5.0 to 80.0 °C (23.0 to 176.0 °F)
Resolution	pH 0.01 or 0.1 pH
	mV* 0.1 or 1 mV
	Temperature 0.1 °C; 0.1 °F
Accuracy	pH ±0.02 pH
	Temperature ±0.5 °C; ±0.9 °F
Calibration	Up to three points or four points * Automatic buffer recognition with Standard buffers Hanna (pH 1.68 *, 4.01, 7.01, 10.01) or NIST (pH 1.68 *, 4.01, 6.86, 9.18)
Temperature compensation	Automatic (ATC) or Manual (MTC) *
Electrode	Body material Glass
	Glass Low Temperature (LT)
	Junction Ceramic
	Reference cell Double, Ag/AgCl
	Electrolyte Gel
	Tip / Shape Spheric
	Outer diameter 12 mm (0.5")
Length 120 mm (4.7")	
Battery type	CR2032 3V Lithium
Battery life	Approximately 1000 hours (500 hours with Bluetooth enabled)
Environment	0 to 50 °C (32 to 122 °F)
IP rating	IP65
Dimensions / Weight	51 x 195 x 21 mm (2.0 x 7.7 x 0.8") / 60 g (2.1 oz.)
Ordering Information	<b>HI9810412</b> (HALO2) is supplied with a starter kit consisting of: pH 4.01 buffer solution sachet (2 pcs.), pH 7.01 buffer solution sachet (2 pcs.), Electrode cleaning solution sachet (2 pcs.), Electrode storage solution (13 mL dropper bottle), 3V Lithium battery - CR2032, Instrument quality certificate and Instruction manual.

## Electrode Features

### Glass body

The HI9810412 features a non-porous glass body that is easy to clean and withstands harsh chemicals.

### Fast, stable readings

The double junction design presents a silver-free electrolyte solution interacting with the sample, making the electrode less susceptible to clogging and guaranteeing a fast response and stable reading.

### Maintenance free

Gel-filled reference with no fill solutions required. Other than routine calibration and cleaning, this probe is maintenance free.

### Built-in Temperature Sensor

Built-in temperature sensor at the tip of the pH electrode allows for rapid determination of the sample temperature and a high-accuracy temperature reading.

\* Available with Hanna Lab App \*\*Measuring outside the recommended operating temperature range may damage the gel electrolyte and void product warranty. Note: The tester can display measurements from -2.00 to 16.00 pH. Measurements outside of the pH range will flash.

App Store is a service mark of Apple Inc., Google Play and the Google Play logo are trademarks of Google LLC. The Bluetooth® word mark and logos are registered trademarks owned by Bluetooth SIG, Inc.

pH solutions begin on page 2.174, pH electrode cleaning solutions begin on page 2.188

HI9810422

# HALO2

**Hanna Lab App  
Compatible**

The Hanna Lab App is available on the App Store® and on Google Play.

## Wireless pH Tester for Field

with built-in specialized electrode

Accurate, and easy to use, HALO2 Wireless pH Tester is ideal for field measurements due to its durability. The HI9810422 can be used as a stand-alone pH tester or can be connected to the Hanna Lab App.

- The integrated Bluetooth module allows the tester to be connected to a compatible smart device with the Hanna Lab App
- Compact, waterproof casing, and automatic pH calibration at up to three points, or four points when used with the Hanna Lab App
- Automatically temperature compensated readings

HALO2 Specifications	HI9810422
Range	pH 0.00 to 12.00 pH
	mV* pH/mV conversion
	Temperature** -5.0 to 70.0 °C (23.0 to 158.0 °F)
Resolution	pH 0.01 or 0.1 pH
	mV* 0.1 or 1 mV
	Temperature 0.1 °C; 0.1 °F
Accuracy	pH ±0.05 pH
	Temperature ±0.5 °C; ±0.9 °F
	Up to three points or four points *
Calibration	Automatic buffer recognition with Standard buffers Hanna (pH 1.68 *, 4.01, 7.01, 10.01) or NIST (pH 1.68 *, 4.01, 6.86, 9.18)
	Temperature compensation Automatic (ATC) or Manual (MTC) *
Electrode	Body material Polyetherimide (PEI) resin
	Glass Low Temperature (LT)
	Junction Ceramic
	Reference cell Double, Ag/AgCl
	Electrolyte Gel
	Tip / Shape Dome
	Outer diameter 12 mm (0.5")
Length 100 mm (3.9")	
Battery type	CR2032 3V Lithium
Battery life	Approximately 1000 hours (500 hours with Bluetooth enabled)
Environment	0 to 50 °C (32 to 122 °F)
IP rating	IP65
Dimensions / Weight	51 x 175 x 21 mm (2.0 x 6.9 x 0.8") / 50 g (1.8 oz.)

### Ordering Information

**HI9810422** (HALO2) is supplied with a starter kit consisting of: pH 4.01 buffer solution sachet (2 pcs.), pH 7.01 buffer solution sachet (2 pcs.), Electrode cleaning solution sachet (2 pcs.), Electrode storage solution (dropper bottle), 3V Lithium battery - CR2032, Instrument quality certificate and Instruction manual.

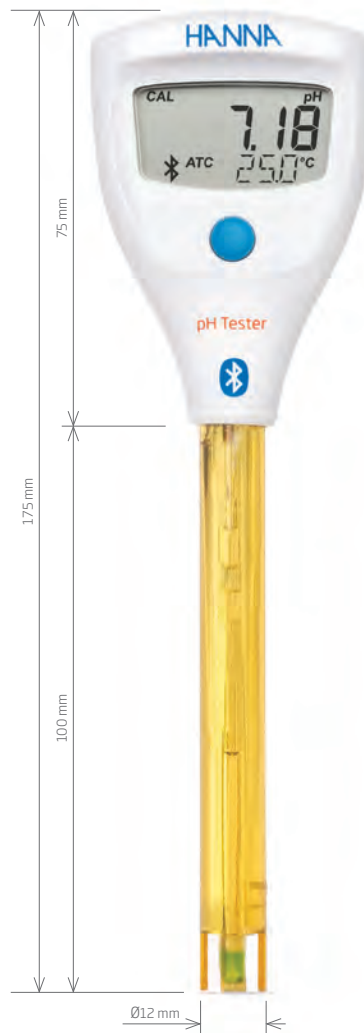

### Maintenance free

Gel-filled reference with no fill solutions required. Other than routine calibration and cleaning, this probe is maintenance free.

## Electrode Features

### PEI Resin body

The HI9810422 features a PEI resin body that is easy to clean and resistant to many aggressive chemicals.

### Fast, stable readings

The double junction design presents a silver-free electrolyte solution interacting with the sample, making the electrode less susceptible to clogging and guaranteeing a fast response and stable reading.

### Built-in Temperature Sensor

Built-in temperature sensor at the tip of the pH electrode allows for rapid determination of the sample temperature and a high-accuracy temperature reading.

\* Available with Hanna Lab App

\*\*Measuring outside the recommended operating temperature range may damage the gel electrolyte and void product warranty. Note: The tester can display measurements from -2.00 to 16.00 pH. Measurements outside of the pH range will flash.

App Store is a service mark of Apple Inc., Google Play and the Google Play logo are trademarks of Google LLC. The Bluetooth® word mark and logos are registered trademarks owned by Bluetooth SIG, Inc.

pH solutions begin on page 2.174, pH electrode cleaning solutions begin on page 2.188



GroLine



### Easy pH electrode cleaning

The PVDF outer junction sleeve can be removed and cleaned. Once cleaned, a small amount of supplied gel electrolyte is added and the junction is refreshed, improving the measurement and extending the life of the tester.

HI9810302

# HALO2



Hanna Lab App  
Compatible

The Hanna Lab App is available on the App Store® and on Google Play.

2

## Wireless pH Tester for Soil

with built-in specialized electrode

Accurate, and easy to use, the HALO2 Wireless pH Tester for Soil is ideal for agricultural, hydroponics, and greenhouse growers that need to monitor the pH of soil or soil slurries. The HI9810302 can be used as a stand-alone pH tester or can be connected to the Hanna Lab App.

- The integrated Bluetooth module allows the tester to be connected to a compatible smart device with the Hanna Lab App
- Compact, waterproof casing, and automatic pH calibration at up to three points, or four points when used with the Hanna Lab App.
- Automatically temperature compensated readings

### HALO2 Specifications HI9810302

Range	pH	0.00 to 12.00 pH
	mV*	pH/mV conversion
	Temperature**	0.0 to 60.0 °C (32.0 to 140.0 °F)
Resolution	pH	0.01 or 0.1 pH
	mV*	0.1 or 1 mV
	Temperature	0.1 °C; 0.1 °F
Accuracy	pH	±0.05 pH
	Temperature	±0.5 °C; ±0.9 °F
Calibration	Up to three points or four points * Automatic buffer recognition with Standard buffers Hanna (pH 1.68 *, 4.01, 7.01, 10.01) or NIST (pH 1.68 *, 4.01, 6.86, 9.18)	
Temperature compensation	Automatic (ATC) or Manual (MTC) *	
Electrode	Body material	Polyvinylidene Fluoride (PVDF)
	Glass	Low Temperature (LT)
	Junction	Open
	Reference cell	Double, Ag/AgCl
	Electrolyte	Gel (refillable)
	Tip / Shape	Conic, Ø 6 x 10 mm (Ø 0.23 x 0.39")
	Outer diameter	8 mm (0.31")
	Length	75 mm (2.95")
Battery type	CR2032 3V Lithium	
Battery life	Approximately 1000 hours (500 hours with Bluetooth enabled)	
Environment	0 to 50 °C (32 to 122 °F)	
IP rating	IP65	
Dimensions / Weight	51 x 150 x 21 mm (2.0 x 5.9 x 0.8") / 45 g (1.6 oz.)	

**HI9810302** (HALO2) is supplied with a starter kit consisting of: pH 4.01 buffer solution, (2 pcs.), pH 7.01 buffer solution sachet (2 pcs.), Cleaning solution for soil deposits sachet (1 pc.), Cleaning solution for humus deposits sachet (1 pc.), Electrode storage solution (dropper bottle), Gelled bridge electrolyte (dropper bottle), 3V Lithium battery - CR2032, Instrument quality certificate, and Instruction manual

### Ordering Information

## Electrode Features

### Rugged PVDF body

The rugged PVDF electrode body is easy to clean. Resistant to most chemicals (e.g. solvents, sodium hypochlorite), ultraviolet light, and fungal growth, the PVDF body also has high-abrasion resistance and mechanical strength.

### Conical tip

The conical tip allows for easy penetration into soil or soil slurries.

### Fast, stable readings

The double junction design presents a silver-free electrolyte solution interacting with the sample, making the electrode less susceptible to clogging and guaranteeing a fast response and stable reading.

### Built-in Temperature Sensor

Built-in temperature sensor at the tip of the pH electrode allows for rapid determination of the sample temperature and a high-accuracy temperature reading.

\* Available with Hanna Lab App \*\*Measuring outside the recommended operating temperature range may damage the gel electrolyte and void product warranty. Note: The tester can display measurements from -2.00 to 16.00 pH. Measurements outside of the pH range will flash.

App Store is a service mark of Apple Inc., Google Play and the Google Play logo are trademarks of Google LLC. The Bluetooth® word mark and logos are registered trademarks owned by Bluetooth SIG, Inc.

pH solutions begin on page 2.174, pH electrode cleaning solutions begin on page 2.188

HI9810432

# HALO2



Hanna Lab App  
Compatible

The Hanna Lab App is  
available on the App Store®  
and on Google Play.

## Wireless Refillable pH Tester for Cosmetic Creams

*with built-in specialized electrode*

Accurate and easy to use, HALO2 Wireless pH Tester for Cosmetic Creams is ideal for measurements in samples that would be a challenge for standard design pH electrodes. The HI9810432 can be used as a stand-alone pH tester or can be connected to the Hanna Lab App.

- The integrated Bluetooth module allows the tester to be connected to a compatible smart device with the Hanna Lab App
- Compact, waterproof casing, and automatic pH calibration at up to three points, or four points when used with the Hanna Lab App
- Automatically temperature compensated readings

HALO2 Specifications	HI9810432	
Range	pH	0.00 to 12.00 pH
	mV*	pH/mV conversion
	Temperature	-5.0 to 70.0 °C (23.0 to 158.0 °F)
Resolution	pH	0.01 or 0.1 pH
	mV*	0.1 or 1 mV
	Temperature	0.1 °C; 0.1 °F
Accuracy	pH	±0.02 pH
	Temperature	±0.5 °C; ±0.9 °F
		Up to three points or four points *
Calibration	Automatic buffer recognition with Standard buffers Hanna (pH 1.68 *, 4.01, 7.01, 10.01) or NIST (pH 1.68 *, 4.01, 6.86, 9.18)	
Temperature compensation	Automatic (ATC) or Manual (MTC) *	
Electrode	Body material	Glass
	Glass	Low Temperature (LT)
	Junction	Triple ceramic
	Reference cell	Double, Ag/AgCl
	Electrolyte	3.5M KCl (refillable)
	Tip / Shape	Conic
	Outer diameter	12 mm (0.5")
Length	120 mm (4.7")	
Battery type	CR2032 3V Lithium	
Battery life	Approximately 1000 hours (500 hours with Bluetooth enabled)	
Environment	0 to 50 °C (32 to 122 °F)	
IP rating	IP65	
Dimensions / Weight	51 x 206 x 21 mm (2.0 x 8.1 x 0.8") / 60 g (2.1 oz.)	

### Ordering Information

**HI9810432** (HALO2) is supplied with a starter kit consisting of: pH 4.01 buffer solution sachet (2 pcs.), pH 7.01 buffer solution sachet (2 pcs.), Electrode cleaning solution sachet (2 pcs.), Electrode storage solution (dropper bottle), Electrolyte refill solution (30 mL), Pipette, 3V Lithium battery - CR2032, Instrument quality certificate and Instruction manual.

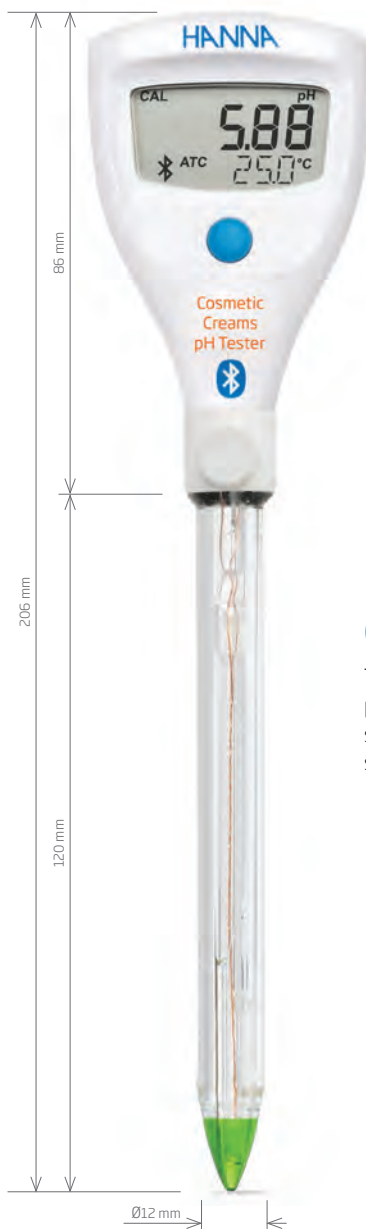

### Conical tip

The conical glass tip allows for penetration into emulsions such as lotions and creams, soft solids, and semisolids.

## Electrode Features

### Glass body

The HI9810432 features a non-porous, glass body that is easy to clean and withstands harsh chemicals.

### Refillable electrode

The triple ceramic junction allows a higher flow rate of electrolyte from the reference cell into the solution. This high flow rate provides faster electrode response and a more stable measurement in viscous solutions or samples of low conductivity. The triple junction design prevents both clogging and any potential precipitation of silver at the junction. The fill solution will diffuse through the ceramic junction as it is used.

### Built-in Temperature Sensor

Built-in temperature sensor at the tip of the pH electrode allows for rapid determination of the sample temperature and a high-accuracy temperature reading.

\* Available with Hanna Lab App  
Note: The tester can display measurements from -2.00 to 16.00 pH. Measurements outside of the pH range will flash.

App Store is a service mark of Apple Inc., Google Play and the Google Play logo are trademarks of Google LLC. The Bluetooth® word mark and logos are registered trademarks owned by Bluetooth SIG, Inc.

pH solutions begin on page 2.174, pH electrode cleaning solutions begin on page 2.188





### Flat tip sensor

The flat glass tip allows for direct contact with the skin or scalp to ensure a stable measurement.

HI9810372

# HALO2



Hanna Lab App  
Compatible

The Hanna Lab App is  
available on the App Store®  
and on Google Play.

2

## Wireless pH Tester for Skin & Scalp

with built-in specialized electrode

Accurate and easy to use, this HALO2 Wireless pH Tester is designed to measure the pH of the skin and scalp. The HI9810372 can be used as a stand-alone pH tester or can be connected to the Hanna Lab App.

- The integrated Bluetooth module allows the tester to be connected to a compatible smart device with the Hanna Lab App
- Compact, waterproof casing, and automatic pH calibration at up to three points, or four points when used with the Hanna Lab App
- Automatically temperature compensated readings

### HALO2 Specifications HI9810372

Range	pH	0.00 to 12.00 pH
	mV*	pH/mV conversion
	Temperature	0.0 to 50.0 °C (32.0 to 122.0 °F)
Resolution	pH	0.01 or 0.1 pH
	mV*	0.1 or 1 mV
	Temperature	0.1 °C; 0.1 °F
Accuracy	pH	±0.05 pH
	Temperature	±0.5 °C; ±0.9 °F
Calibration	Up to three points or four points *	
Calibration	Automatic buffer recognition with Standard buffers Hanna (pH 1.68 *, 4.01, 7.01, 10.01) or NIST (pH 1.68 *, 4.01, 6.86, 9.18)	
Temperature compensation	Automatic (ATC) or Manual (MTC) *	
Electrode	Body material	Glass
	Glass	Low Temperature (LT)
	Junction	Open
	Reference cell	Double, Ag/AgCl
	Electrolyte	Viscolene
	Tip / Shape	Flat
	Outer diameter	12 mm (0.47")
	Length	75 mm (2.95")
Battery type	CR2032 3V Lithium	
Battery life	Approximately 1000 hours (500 hours with Bluetooth enabled)	
Environment	0 to 50 °C (32 to 122 °F)	
IP rating	IP65	
Dimensions / Weight	51 x 150 x 21 mm (2.0 x 5.9 x 0.8") / 50 g (1.8 oz.)	
Ordering Information	<b>HI9810372</b> (HALO2) is supplied with a starter kit consisting of: pH 4.01 buffer solution sachet (2 pcs.), pH 7.01 buffer solution sachet (2 pcs.), Cleaning and disinfection solution for skin residuals sachet (1 pc.), Electrode cleaning solution for skin grease and sebum sachet (1 pc.), Electrode storage solution (dropper bottle), 3V Lithium battery - CR2032, Instrument quality certificate and Instruction manual	

## Electrode Features

### Glass body

The HI9810372 features a non-porous glass body that is easy to clean and disinfect.

### Fast, stable readings

The open junction reference provides for a direct contact with the skin or scalp, ensuring a stable measurement.

The double junction design presents a silver-free electrolyte solution interacting with the sample, making the electrode less susceptible to clogging and guaranteeing a fast response and stable reading.

### Built-in Temperature Sensor

Built-in temperature sensor at the tip of the pH electrode allows for rapid determination of the sample temperature and a high-accuracy temperature reading.

\* Available with Hanna Lab App  
Note: The tester can display measurements from -2.00 to 16.00 pH. Measurements outside of the pH range will flash.

App Store is a service mark of Apple Inc., Google Play and the Google Play logo are trademarks of Google LLC. The Bluetooth® word mark and logos are registered trademarks owned by Bluetooth SIG, Inc.

HI9810442

# HALO2



Hanna Lab App  
Compatible

The Hanna Lab App is  
available on the App Store®  
and on Google Play.

## Wireless pH Tester for Leather and Paper

with built-in specialized electrode

Accurate and easy to use, HALO2 Wireless pH Tester for Leather & Paper is ideal for measurements on flat surfaces, or small volume samples, with the specially designed flat sensing tip. The HI9810442 can be used as a stand-alone pH tester or can be connected to the Hanna Lab App.

- The integrated Bluetooth module allows the tester to be connected to a compatible smart device with the Hanna Lab App
- Compact, waterproof casing, and automatic pH calibration at up to three points, or four points when used with the Hanna Lab App
- Automatically temperature compensated readings

### HALO2 Specifications HI9810442

Range	pH	0.00 to 12.00 pH
	mV*	pH/mV conversion
	Temperature	0.0 to 50.0 °C (32.0 to 122.0 °F)
Resolution	pH	0.01 or 0.1 pH
	mV*	0.1 or 1 mV
	Temperature	0.1 °C; 0.1 °F
Accuracy	pH	±0.02 pH
	Temperature	±0.5 °C; ±0.9 °F
Calibration	Up to three points or four points *	
	Automatic buffer recognition with Standard buffers Hanna (pH 1.68 *, 4.01, 7.01, 10.01) or NIST (pH 1.68 *, 4.01, 6.86, 9.18)	
Temperature compensation	Automatic (ATC) or Manual (MTC) *	
Electrode	Body material	Glass
	Glass	Low Temperature (LT)
	Junction	Ceramic
	Reference cell	Double, Ag/AgCl
	Electrolyte	Viscolene
	Tip / Shape	Flat
	Outer diameter	12 mm (0.5")
Length	110 mm (4.3")	
Battery type	CR2032 3V Lithium	
Battery life	Approximately 1000 hours (500 hours with Bluetooth enabled)	
Environment	0 to 50 °C (32 to 122 °F)	
IP rating	IP65	
Dimensions / Weight	51 x 185 x 21 mm (2.0 x 7.3 x 0.8") / 60 g (2.1 oz.)	

### Ordering Information

**HI9810442** (HALO2) is supplied with a starter kit consisting of: pH 4.01 buffer solution sachet (2 pcs.), pH 7.01 buffer solution sachet (2 pcs.), Electrode cleaning solution sachet (2 pcs.), Electrode storage solution (dropper bottle), 3V Lithium battery - CR2032, Instrument quality certificate and instruction manual.



### Flat tip

Just one drop of water needed on the sample surface for accurate measurements. Easy to clean electrode with a flat tip for maximum surface contact.

## Electrode Features

### Glass body

The HI9810442 features a non-porous glass body that is easy to clean and withstands harsh chemicals.

### Maintenance free

Gel-filled reference with no fill solutions required. Other than routine calibration and cleaning, this probe is maintenance free.

### Fast, stable readings

The double junction design presents a silver-free electrolyte solution interacting with the sample, making the electrode less susceptible to clogging and guaranteeing a fast response and stable reading.

### Built-in Temperature Sensor

Built-in temperature sensor at the tip of the pH electrode allows for rapid determination of the sample temperature and a high-accuracy temperature reading.

\* Available with Hanna Lab App  
Note: The tester can display measurements from -2.00 to 16.00 pH. Measurements outside of the pH range will flash.

App Store is a service mark of Apple Inc., Google Play and the Google Play logo are trademarks of Google LLC. The Bluetooth® word mark and logos are registered trademarks owned by Bluetooth SIG, Inc.

pH solutions begin on page 2.174, pH electrode cleaning solutions begin on page 2.188



### Flat tip

The flat glass tip allows for direct pH measurement and prevents mash and cooled wort solids from collecting on the surface.

HI9810312

# HALO2



Hanna Lab App  
Compatible

The Hanna Lab App is available on the App Store® and on Google Play.

2

## Wireless pH Tester for Beer

with built-in specialized electrode

Accurate and easy to use, HALO2 Wireless pH Tester for Beer is ideal for pH measurement of mash, cooled wort, and beer samples. The HI9810312 can be used as a stand-alone pH tester or can be connected to the Hanna Lab App.

- The integrated Bluetooth module allows the tester to be connected to a compatible smart device with the Hanna Lab App
- Compact, waterproof casing, and automatic pH calibration at up to three points, or four points when used with the Hanna Lab App
- Automatically temperature compensated readings

pH

## Electrode Features

### Titanium body

The titanium body offers protection from accidental breakage. Rugged and resilient, the titanium works as an electronic shield protecting against interferences from electrical noise or humidity.

### Extractable cloth junction

The extractable cloth junction allows for clearing any clogging from solids that cause slow response and unstable readings. Pull 3 mm (1/8") to expose a fresh new junction surface for faster response times and reading stability.

### Fast, stable readings

The double junction design presents a silver-free electrolyte solution interacting with the sample, making the electrode less susceptible to clogging and guaranteeing a fast response and stable reading.

### Built-in Temperature Sensor

Built-in temperature sensor at the tip of the pH electrode allows for rapid determination of the sample temperature and a high-accuracy temperature reading.

### HALO2 Specifications

### HI9810312

Range	pH	0.00 to 12.00 pH
	mV*	pH/mV conversion
	Temperature**	0.0 to 80.0 °C (32.0 to 176.0 °F)
Resolution	pH	0.01 or 0.1 pH
	mV*	0.1 or 1 mV
Accuracy	Temperature	0.1 °C; 0.1 °F
	pH	±0.05 pH
Calibration	Temperature	±0.5 °C; ±0.9 °F
	Up to three points or four points *	
Temperature compensation	Automatic buffer recognition with Standard buffers Hanna (pH 1.68 *, 4.01, 7.01, 10.01) or NIST (pH 1.68 *, 4.01, 6.86, 9.18)	
	Automatic (ATC) or Manual (MTC) *	
Electrode	Body material	Titanium
	Glass	Low Temperature (LT)
	Junction	Cloth (extractable)
	Reference cell	Double, Ag/AgCl
	Electrolyte	Gel
	Tip / Shape	Flat
	Outer diameter	12 mm (0.47")
	Length	110 mm (4.3")
Battery type	CR2032 3V Lithium	
Battery life	Approximately 1000 hours (500 hours with Bluetooth enabled)	
Environment	0 to 50 °C (32 to 122 °F)	
IP rating	IP65	
Dimensions / Weight	51 x 185 x 21 mm (2 x 7.3 x 0.8") / 60 g (2.1 oz.)	
Ordering Information	<p><b>HI9810312</b> (HALO2) is supplied with a starter kit consisting of: pH 4.01 buffer solution sachet (2 pcs.), pH 7.01 buffer solution sachet (2 pcs.), Cleaning solution for brewing deposits sachet (2 pcs.), Electrode storage solution (dropper bottle), 3V Lithium battery - CR2032, Instrument quality certificate and Instruction manual</p>	

HALO2

\* Available with Hanna Lab App \*\*Measuring outside the recommended operating temperature range may damage the gel electrolyte and void product warranty. Note: The tester can display measurements from -2.00 to 16.00 pH. Measurements outside of the pH range will flash.

App Store is a service mark of Apple Inc., Google Play and the Google Play logo are trademarks of Google LLC. The Bluetooth® word mark and logos are registered trademarks owned by Bluetooth SIG, Inc.

pH solutions begin on page 2.174, pH electrode cleaning solutions begin on page 2.188

HI9810332

HALO2

Hanna Lab App  
CompatibleThe Hanna Lab App is  
available on the App Store®  
and on Google Play.

## Wireless Refillable pH Tester for Wine

with built-in specialized electrode

Accurate and easy to use, HALO2 Wireless pH Tester for Wine is designed to measure the pH at each step of the winemaking process: from pre-fermentation and fermentation to post-fermentation and bottling. The HI9810332 can be used as a stand-alone pH tester or can be connected to the Hanna Lab App.

- The integrated Bluetooth module allows the tester to be connected to a compatible smart device with the Hanna Lab App
- Compact, waterproof casing, and automatic pH calibration at up to three points, or four points when used with the Hanna Lab App
- Automatically temperature compensated readings

### HALO2 Specifications HI9810332

Range	pH	0.00 to 12.00 pH
	mV*	pH/mV conversion
	Temperature	0.0 to 60.0 °C (32.0 to 140.0 °F)
Resolution	pH	0.01 or 0.1 pH
	mV*	0.1 or 1 mV
	Temperature	0.1 °C; 0.1 °F
Accuracy	pH	±0.05 pH
	Temperature	±0.5 °C; ±0.9 °F
Calibration	Up to three points or four points *	
	Automatic buffer recognition with Standard buffers Hanna (pH 1.68 *, 3.00, 7.01, 10.01) or NIST (pH 1.68 *, 3.00, 6.86, 9.18)	
Temperature compensation	Automatic (ATC) or Manual (MTC) *	
Electrode	Body material	Glass
	Glass	Low Temperature (LT)
	Junction	Open (movable)
	Reference cell	Double, Ag/AgCl
Electrode	Electrolyte	3.5M KCl (refillable)
	Tip / Shape	Dome, Ø 8 mm (Ø 0.31")
	Outer diameter	12 mm (0.5")
	Length	120 mm (4.7")
	Battery type	CR2032 3V Lithium
Battery life	Approximately 1000 hours (500 hours with Bluetooth enabled)	
Environment	0 to 50 °C (32 to 122 °F)	
IP rating	IP65	
Dimensions / Weight	51 x 206 x 21 mm (2.0 x 8.1 x 0.8") / 55 g (2.0 oz.)	

**HI9810332** (HALO2) is supplied with a starter kit consisting of: pH 3.00 buffer solution sachet (2 pcs.), pH 7.01 buffer solution sachet (2 pcs.), Cleaning solution for wine deposits sachet (1 pc.), Cleaning solution for wine stains sachet (1 pc.), Electrode storage solution (dropper bottle), Electrolyte refill solution, Pipette, 3V Lithium battery - CR2032, Instrument quality certificate and Instruction manual.

### Ordering Information

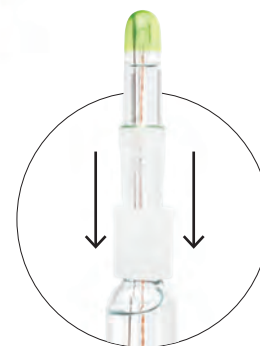

### Clogging Prevention System (CPS™) technology

The moveable PE sleeve repels solids and prevents clogging. Additionally, the sleeve can be moved and the ground glass surface cleaned, resulting in faster response times and stable readings.

### Domed Tip

The domed tip allows a large surface area to be in contact with the sample.

## Electrode Features

### Glass body

The HI9810332 features a non-porous glass body that is easy to clean. Specialized low temperature (LT) pH glass ensures fast stabilization and accurate results at lower temperatures.

### Refillable electrode

The double junction design presents a silver-free electrolyte solution interacting with the sample, making the electrode less susceptible to clogging and guaranteeing a fast response and stable reading.



### Built-in Temperature Sensor

Built-in temperature sensor at the tip of the pH electrode allows for rapid determination of the sample temperature and a high-accuracy temperature reading.

\* Available with Hanna Lab App  
Note: The tester can display measurements from -2.00 to 16.00 pH. Measurements outside of the pH range will flash.

App Store is a service mark of Apple Inc., Google Play and the Google Play logo are trademarks of Google LLC. The Bluetooth® word mark and logos are registered trademarks owned by Bluetooth SIG, Inc.

pH solutions begin on page 2.174, pH electrode cleaning solutions begin on page 2.188

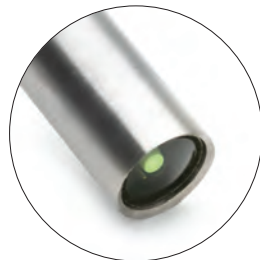

### Flat tip, clog-resistant electrode

The flat glass tip provides optimal surface contact for sushi rice pH measurements and for surfaces that cannot be penetrated. Clog resistant open junction reference due to the hard gel surface (viscolene) that is used for the reference cell. When the junction becomes coated with starch from the rice, clean the probe to expose the hard gel (viscolene) reference.

## Electrode Features

### Titanium body

The titanium body offers protection from accidental breakage. Rugged and resilient, the titanium works as an electronic shield protecting against interferences from electrical noise or humidity.

### Fast, stable readings

The double junction design presents a silver-free electrolyte solution interacting with the sample, making the electrode less susceptible to clogging and guaranteeing a fast response and stable reading.

### Built-in Temperature Sensor

Built-in temperature sensor at the tip of the pH electrode allows for rapid determination of the sample temperature and a high-accuracy temperature reading.

\* Available with Hanna Lab App  
 Note: The tester can display measurements from -2.00 to 16.00 pH. Measurements outside of the pH range will flash.  
 App Store is a service mark of Apple Inc., Google Play and the Google Play logo are trademarks of Google LLC.  
 The Bluetooth® word mark and logos are registered trademarks owned by Bluetooth SIG, Inc.

pH solutions begin on page 2.174, pH electrode cleaning solutions begin on page 2.188

HI9810352

# HALO2



Hanna Lab App  
Compatible

The Hanna Lab App is available on the App Store® and on Google Play.

2

pH

HALO2

## Wireless pH Tester for Sushi

with built-in specialized electrode

Accurate and easy to use, HALO2 Wireless pH Tester for Sushi is designed to measure the pH of sushi rice and ensure it meets the food-hygiene and Hazard Analysis Critical Control Point (HACCP) regulations. The HI9810352 can be used as a stand-alone pH tester or can be connected to the Hanna Lab App.

- The integrated Bluetooth module allows the tester to be connected to a compatible smart device with the Hanna Lab App
- Compact, waterproof casing, and automatic pH calibration at up to three points, or four points when used with the Hanna Lab App
- Automatically temperature compensated readings

### HALO2 Specifications HI9810352

Range	pH	0.00 to 12.00 pH
	mV*	pH/mV conversion
	Temperature	0.0 to 50.0 °C (32.0 to 122.0 °F)
Resolution	pH	0.01 or 0.1 pH
	mV*	0.1 or 1 mV
	Temperature	0.1 °C; 0.1 °F
Accuracy	pH	±0.05 pH
	Temperature	±0.5 °C; ±0.9 °F
Calibration	Up to three points or four points *	
	Automatic buffer recognition with Standard buffers Hanna (pH 1.68 *, 4.01, 7.01, 10.01) or NIST (pH 1.68 *, 4.01, 6.86, 9.18)	
Temperature compensation	Automatic (ATC) or Manual (MTC) *	
Electrode	Body material	Titanium
	Glass	Low Temperature (LT)
	Junction	Open
	Reference cell	Double, Ag/AgCl
	Electrolyte	Viscolene
	Tip / Shape	Flat
	Outer diameter	12.7 mm (0.5")
Battery type	CR2032 3V Lithium	
Battery life	Approximately 1000 hours (500 hours with Bluetooth enabled)	
Environment	0 to 50 °C (32 to 122 °F)	
IP rating	IP65	
Dimensions / Weight	51 x 160 x 21 mm (2.0 x 6.3 x 0.8") / 60 g (2.1 oz.)	

### Ordering Information

**HI9810352** (HALO2) is supplied with a starter kit consisting of: pH 4.01 buffer solution sachet (2 pcs.), pH 7.01 buffer solution sachet (2 pcs.), Cleaning solution for sushi sachet (2 pcs.), Electrode storage solution (dropper bottle), 3V Lithium battery - CR2032, Instrument quality certificate and Instruction manual

HI9810342

# HALO2



Hanna Lab App  
Compatible

The Hanna Lab App is  
available on the App Store®  
and on Google Play.

## Wireless pH Tester for Milk

with built-in specialized electrode

Accurate and easy to use, the HALO2 Wireless pH Tester for Milk is designed to measure the pH during the milk production process. The HI9810342 can be used as a stand-alone pH tester or can be connected to the Hanna Lab App.

- The integrated Bluetooth module allows the tester to be connected to a compatible smart device with the Hanna Lab App
- Compact, waterproof casing, and automatic pH calibration at up to three points, or four points when used with the Hanna Lab App
- Automatically temperature compensated readings

### HALO2 Specifications HI9810342

Range	pH	0.00 to 12.00 pH
	mV*	pH/mV conversion
	Temperature**	0.0 to 60.0 °C (32.0 to 140.0 °F)
Resolution	pH	0.01 or 0.1 pH
	mV*	0.1 or 1 mV
	Temperature	0.1 °C; 0.1 °F
Accuracy	pH	±0.05 pH
	Temperature	±0.5 °C; ±0.9 °F
Calibration	Up to three points or four points *	
	Automatic buffer recognition with Standard buffers Hanna (pH 1.68 *, 4.01, 7.01, 10.01) or NIST (pH 1.68 *, 4.01, 6.86, 9.18)	
Temperature compensation	Automatic (ATC) or Manual (MTC) *	
Electrode	Body material	Glass
	Glass	Low Temperature (LT)
	Junction	Open
	Reference cell	Double, Ag/AgCl
	Electrolyte	Gel
	Tip / Shape	Conic, Ø 12 x 12 mm (Ø 0.47 x 0.47")
	Outer diameter	12 mm (0.5")
	Length	85 mm (3.3")
Battery type	CR2032 3V Lithium	
Battery life	Approximately 1000 hours (500 hours with Bluetooth enabled)	
Environment	0 to 50 °C (32 to 122 °F)	
IP rating	IP65	
Dimensions / Weight	51 x 160 x 21 mm (2.0 x 6.3 x 0.8") / 50 g (1.8 oz.)	

### Ordering Information

**HI9810342** (HALO2) is supplied with a starter kit consisting of: pH 4.01 buffer solution sachet (2 pcs.), pH 7.01 buffer solution sachet (2 pcs.), Cleaning solution for milk deposits sachet (2 pcs.), Electrode storage solution (dropper bottle), 3V Lithium battery - CR2032, Instrument quality certificate and Instruction manual



### Conical tip

The conical tip allows for easy penetration into semisolids, ideal for milk and milk products like yogurt.

## Electrode Features

### Glass body

The HI9810342 features a non-porous glass body that is easy to clean and disinfect.

### Maintenance free

Gel-filled reference with no fill solutions required. Other than routine calibration and cleaning, this probe is maintenance free.

### Fast, stable readings

The double junction design presents a silver-free electrolyte solution interacting with the sample, making the electrode less susceptible to clogging and guaranteeing a fast response and stable reading.

### Low temperature glass

Specialized low temperature (LT) pH glass ensures fast stabilization and accurate results at lower temperatures.

### Built-in Temperature Sensor

Built-in temperature sensor at the tip of the pH electrode allows for rapid determination of the sample temperature and a high-accuracy temperature reading.

\* Available with Hanna Lab App

\*\*Measuring outside the recommended operating temperature range may damage the gel electrolyte and void product warranty. Note: The tester can display measurements from -2.00 to 16.00 pH. Measurements outside of the pH range will flash.

App Store is a service mark of Apple Inc., Google Play and the Google Play logo are trademarks of Google LLC. The Bluetooth® word mark and logos are registered trademarks owned by Bluetooth SIG, Inc.

pH solutions begin on page 2.174, pH electrode cleaning solutions begin on page 2.188



### Conical tip

The conical tip allows for easy penetration into solids and semisolids such as cheese.

HI9810322

# HALO2



Hanna Lab App  
Compatible

The Hanna Lab App is  
available on the App Store®  
and on Google Play.

2

## Wireless pH Tester for Cheese

*with built-in specialized electrode*

Accurate and easy to use, HALO2 Wireless pH Tester for Cheese is designed to measure and monitor pH during the main processing steps of cheese manufacturing and ensure it meets the food-hygiene and Hazard Analysis Critical Control Point (HACCP) regulations. The HI9810322 can be used as a stand-alone pH tester or can be connected to the Hanna Lab App.

- The integrated Bluetooth module allows the tester to be connected to a compatible smart device with the Hanna Lab App
- Compact, waterproof casing, and automatic pH calibration at up to three points, or four points when used with the Hanna Lab App
- Automatically temperature compensated readings

### HALO2 Specifications HI9810322

Range	pH	0.00 to 12.00 pH
	mV*	pH/mV conversion
	Temperature	0.0 to 60.0 °C (32.0 to 140.0 °F)
Resolution	pH	0.01 or 0.1 pH
	mV*	0.1 or 1 mV
Accuracy	pH	±0.05 pH
	Temperature	±0.5 °C; ±0.9 °F
Calibration	Up to three points or four points *	
	Automatic buffer recognition with Standard buffers Hanna (pH 1.68 *, 4.01, 7.01, 10.01) or NIST (pH 1.68 *, 4.01, 6.86, 9.18)	
Temperature compensation	Automatic (ATC) or Manual (MTC) *	
Electrode	Body material	Polyvinylidene Fluoride (PVDF)
	Glass	Low Temperature (LT)
	Junction	Open
	Reference cell	Double, Ag/AgCl
	Electrolyte	Viscolene
	Tip / Shape	Conic, Ø 6 x 10 mm (Ø 0.23 x 0.39")
	Outer diameter	8 mm (0.31")
Battery type	CR2032 3V Lithium	
Battery life	Approximately 1000 hours (500 hours with Bluetooth enabled)	
Environment	0 to 50 °C (32 to 122 °F)	
IP rating	IP65	
Dimensions / Weight	51 x 146 x 21 mm (2.0 x 5.7 x 0.8") / 45 g (1.6 oz.)	

**HI9810322** (HALO2) is supplied with a starter kit consisting of: pH 4.01 buffer solution sachet (2 pcs.), pH 7.01 buffer solution sachet (2 pcs.), Cleaning solution for cheese deposits sachet (2 pcs.), Electrode storage solution (dropper bottle), 3V Lithium battery - CR2032, Instrument quality certificate and Instruction manual.

### Ordering Information

## Electrode Features

### Food grade PVDF body

The food grade PVDF body material is easy to clean and disinfect. Resistant to most chemicals (e.g. solvents, sodium hypochlorite), ultraviolet light, and fungal growth, the PVDF body also has high-abrasion resistance and mechanical strength.

### Fast, stable readings

The double junction design presents a silver-free electrolyte solution interacting with the sample, making the electrode less susceptible to clogging and guaranteeing a fast response and stable reading.

### Built-in Temperature Sensor

Built-in temperature sensor at the tip of the pH electrode allows for rapid determination of the sample temperature and a high-accuracy temperature reading.

\* Available with Hanna Lab App  
Note: The tester can display measurements from -2.00 to 16.00 pH. Measurements outside of the pH range will flash.

App Store is a service mark of Apple Inc., Google Play and the Google Play logo are trademarks of Google LLC. The Bluetooth® word mark and logos are registered trademarks owned by Bluetooth SIG, Inc.

pH solutions begin on page 2.174, pH electrode cleaning solutions begin on page 2.188



## Wireless pH Tester for Meat

with built-in specialized electrode

Accurate and easy to use, HALO2 Wireless pH Testers for Meat are ideal for pH measurement during meat processing. These testers can be used as a stand-alone pH tester or can be connected to the Hanna Lab App.

- The integrated Bluetooth module allows the tester to be connected to a compatible smart device with the Hanna Lab App
- Compact, waterproof casing, and automatic pH calibration at up to three points, or four points when used with the Hanna Lab App
- Automatically temperature compensated readings
- Removable stainless steel meat blade available (HI9810452)

HALO2 Specifications		HI9810362	HI9810452
Range	pH	0.00 to 12.00 pH	
	mV*	pH/mV conversion	
	Temperature**	0.0 to 60.0 °C (32.0 to 140.0 °F)	
Resolution	pH	0.01 or 0.1 pH	
	mV*	0.1 or 1 mV	
	Temperature	0.1 °C; 0.1 °F	
Accuracy	pH	±0.05 pH	
	Temperature	±0.5 °C; ±0.9 °F	
		Up to three points or four points *	
Calibration		Automatic buffer recognition with Standard buffers Hanna (pH 1.68 *, 4.01, 7.01, 10.01) or NIST (pH 1.68 *, 4.01, 6.86, 9.18)	
	Temperature compensation	Automatic (ATC) or Manual (MTC) *	
Electrode	Body material	Polyvinylidene Fluoride (PVDF)	
	Glass	Low Temperature (LT)	
	Junction	Open	
	Reference cell	Double, Ag/AgCl	
	Electrolyte	Gel (refillable)	
	Tip / Shape	Conic, Ø 6 x 10 mm (Ø 0.23 x 0.39")	
	Outer diameter	8 mm (0.31")	
	Length	75 mm (2.95")	
Blade Compatible	no	yes, FC097	
Battery type	CR2032 3V Lithium		
Battery life			
Environment	0 to 50 °C (32 to 122 °F)		
IP rating	IP65		
Dimensions / Weight	51 x 150 x 21 mm (2.0 x 5.9 x 0.8") / 45 g (1.6 oz.)		
Ordering Information	<b>HI9810362</b> (HALO2) and <b>HI9810452</b> (HALO2 with thread) is supplied with a starter kit consisting of: pH 4.01 buffer solution sachet (2 pcs.), pH 7.01 buffer solution sachet (2 pcs.), Electrode cleaning solution for Meat, Grease, and Fats (2 pcs.), Electrode storage solution (dropper bottle), Gelled bridge electrolyte (dropper bottle), 3V Lithium battery - CR2032, Instrument quality certificate and instruction manual.		
	Accessories	<b>FC097</b> stainless steel meat blade for HI9810452	



## Electrode Features

### Food grade PVDF body

The food grade PVDF body material is easy to clean and disinfect. Resistant to most chemicals (e.g. solvents, sodium hypochlorite), ultraviolet light, and fungal growth, the PVDF body also has high-abrasion resistance and mechanical strength.

### Conical tip

The conical tip allows for easy penetration into solids and semisolids such as meats and sausages.

### Removable stainless steel meat blade available (HI9810452 only)

HI9810452 features threads at the base of the probe for compatibility with the FC097 stainless steel meat blade (optional accessory).

### Fast, stable readings

The double junction design presents a silver-free electrolyte solution interacting with the sample, making the electrode less susceptible to clogging and guaranteeing a fast response and stable reading.

### Built-in temperature sensor

Built-in temperature sensor at the tip of the pH electrode allows for rapid determination of the sample temperature and a high-accuracy temperature reading.

\* Available with Hanna Lab App

\*\*Measuring outside the recommended operating temperature range may damage the gel electrolyte and void product warranty. Note: The tester can display measurements from -2.00 to 16.00 pH. Measurements outside of the pH range will flash.

App Store is a service mark of Apple Inc., Google Play and the Google Play logo are trademarks of Google LLC. The Bluetooth® word mark and logos are registered trademarks owned by Bluetooth SIG, Inc.

pH solutions begin on page 2.174, pH electrode cleaning solutions begin on page 2.188





### Easy pH electrode cleaning

The PVDF outer junction sleeve can be removed for cleaning, disinfecting, and refreshing (with supplied gel electrolyte) of the outer reference area. Once cleaned, a small amount of supplied gel electrolyte is added and the junction is refreshed, improving the measurement and extending the life of the tester.

HI9810392

# HALO2



Hanna Lab App  
Compatible

The Hanna Lab App is available on the App Store® and on Google Play.

2

## Wireless pH Tester for Chocolate

with built-in specialized electrode

Accurate and easy to use, HALO2 Wireless pH Tester for Chocolate is ideal for pH measurement during the chocolate making process. The HI9810392 can be used as a stand-alone pH tester or can be connected to the Hanna Lab App.

- The integrated Bluetooth module allows the tester to be connected to a compatible smart device with the Hanna Lab App.
- Compact, waterproof casing, and automatic pH calibration at up to three points, or four points when used with the Hanna Lab App.
- Automatically temperature compensated readings

### HALO2 Specifications HI9810392

Range	pH	0.00 to 12.00 pH
	mV*	pH/mV conversion
	Temperature**	0.0 to 60.0 °C (32.0 to 140.0 °F)
Resolution	pH	0.01 or 0.1 pH
	mV*	0.1 or 1 mV
	Temperature	0.1 °C; 0.1 °F
Accuracy	pH	±0.05 pH
	Temperature	±0.5 °C; ±0.9 °F
Calibration	Up to three points or four points *	
	Automatic buffer recognition with Standard buffers Hanna (pH 1.68 *, 4.01, 7.01, 10.01) or NIST (pH 1.68 *, 4.01, 6.86, 9.18)	
Temperature compensation	Automatic (ATC) or Manual (MTC) *	
Electrode	Body material	Polyvinylidene Fluoride (PVDF)
	Glass	Low Temperature (LT)
	Junction	Open
	Reference cell	Double, Ag/AgCl
	Electrolyte	Gel (refillable)
	Tip / Shape	Conic, Ø 6 x 10 mm (Ø 0.23 x 0.39")
	Outer diameter	8 mm (0.31")
Battery type	CR2032 3V Lithium	
Battery life	Approximately 1000 hours (500 hours with Bluetooth enabled)	
Environment	0 to 50 °C (32 to 122 °F)	
IP rating	IP65	
Dimensions / Weight	51 x 150 x 21 mm (2.0 x 5.9 x 0.8") / 45 g (1.6 oz.)	

**HI9810392** (HALO2) is supplied with a starter kit consisting of: pH 4.01 buffer solution sachet (2 pcs.), pH 7.01 buffer solution sachet (2 pcs.), Electrode cleaning and disinfection solution for chocolate deposits sachet (2 pcs.), Electrode storage solution, (dropper bottle), Gelled bridge electrolyte (dropper bottle), 3V Lithium battery – CR2032, Instrument quality certificate and Instruction manual.

### Ordering Information

## Electrode Features

### Food grade PVDF body

The food grade PVDF body material is easy to clean and disinfect. Resistant to most chemicals (e.g. solvents, sodium hypochlorite), ultraviolet light, and fungal growth, the PVDF body also has high-abrasion resistance and mechanical strength.

### Conical tip

The conical tip allows for easy penetration into solids and semisolids such as chocolate.

### Fast, stable readings

The double junction design presents a silver-free electrolyte solution interacting with the sample, making the electrode less susceptible to clogging and guaranteeing a fast response and stable reading.

### Built-in Temperature Sensor

Built-in temperature sensor at the tip of the pH electrode allows for rapid determination of the sample temperature and a high-accuracy temperature reading.

\* Available with Hanna Lab App \*\*Measuring outside the recommended operating temperature range may damage the gel electrolyte and void product warranty. Note: The tester can display measurements from -2.00 to 16.00 pH. Measurements outside of the pH range will flash.

App Store is a service mark of Apple Inc., Google Play and the Google Play logo are trademarks of Google LLC. The Bluetooth® word mark and logos are registered trademarks owned by Bluetooth SIG, Inc.

pH

HALO2





### Conical tip

The conical tip allows for easy penetration into solids and semisolids such as bread and dough..

HI9810382

# HALO2



Hanna Lab App  
Compatible

The Hanna Lab App is  
available on the App Store®  
and on Google Play.

2

## Wireless pH Tester for Bread & Dough

with built-in specialized electrode

Accurate and easy to use, HALO2 Wireless pH Tester for Bread & Dough is ideal to measure the pH during baking processes and ensure it meets the food-hygiene and Hazard Analysis Critical Control Point (HACCP) regulations. The HI9810382 can be used as a stand-alone pH tester or can be connected to the Hanna Lab App.

- The integrated Bluetooth module allows the tester to be connected to a compatible smart device with the Hanna Lab App
- Compact, waterproof casing, and automatic pH calibration at up to three points, or four points when used with the Hanna Lab App
- Automatically temperature compensated readings

pH

### HALO2 Specifications HI9810382

Range	pH	0.00 to 12.00 pH
	mV*	pH/mV conversion
	Temperature**	0.0 to 60.0 °C (32.0 to 140.0 °F)
Resolution	pH	0.01 or 0.1 pH
	mV*	0.1 or 1 mV
	Temperature	0.1 °C; 0.1 °F
Accuracy	pH	±0.05 pH
	Temperature	±0.5 °C; ±0.9 °F
Calibration	Up to three points or four points *	
	Automatic buffer recognition with Standard buffers Hanna (pH 1.68 *, 4.01, 7.01, 10.01) or NIST (pH 1.68 *, 4.01, 6.86, 9.18)	
Temperature compensation	Automatic (ATC) or Manual (MTC) *	
Electrode	Body material	Polyvinylidene Fluoride (PVDF)
	Glass	Low Temperature (LT)
	Junction	Open
	Reference cell	Double, Ag/AgCl
	Electrolyte	Viscolene
	Tip / Shape	Conic, Ø6 x 10 mm (Ø 0.23 x 0.39")
	Outer diameter	8 mm (0.31")
Battery type	CR2032 3V Lithium	
Battery life	Approximately 1000 hours (500 hours with Bluetooth enabled)	
Environment	0 to 50 °C (32 to 122 °F)	
IP rating	IP65	
Dimensions / Weight	51 x 146 x 21 mm (2.0 x 5.7 x 0.8") / 45 g (1.6 oz.)	

**HI9810382** (HALO2) is supplied with a starter kit consisting of: pH 4.01 buffer solution sachet (2 pcs.), pH 7.01 buffer solution sachet (2 pcs.), Electrode cleaning and disinfection solution for bread and dough deposits sachet (2 pcs.), Electrode storage solution (dropper bottle), 3V Lithium battery - CR2032, Instrument quality certificate and Instruction manual.

### Ordering Information

## Electrode Features

### Food grade PVDF body

The food grade PVDF body material is easy to clean and disinfect. Resistant to most chemicals (e.g. solvents, sodium hypochlorite), ultraviolet light, and fungal growth, the PVDF body also has high-abrasion resistance and mechanical strength.

### Fast, stable readings

The double junction design presents a silver-free electrolyte solution interacting with the sample, making the electrode less susceptible to clogging and guaranteeing a fast response and stable reading.

### Built-in Temperature Sensor

Built-in temperature sensor at the tip of the pH electrode allows rapid determination of the sample temperature and a high-accuracy temperature reading.

\* Available with Hanna Lab App \*\*Measuring outside the recommended operating temperature range may damage the gel electrolyte and void product warranty. Note: The tester can display measurements from -2.00 to 16.00 pH. Measurements outside of the pH range will flash.

App Store is a service mark of Apple Inc., Google Play and the Google Play logo are trademarks of Google LLC. The Bluetooth® word mark and logos are registered trademarks owned by Bluetooth SIG, Inc.

pH solutions begin on page 2.174, pH electrode cleaning solutions begin on page 2.188

HALO2



# HALO®

Wireless pH Meters

## Take lab grade measurements using a smart phone or tablet

HALO is the world's first professional pH probe with Bluetooth® Smart technology (Bluetooth® 4.0). This technology is energy efficient, allowing for low power consumption to maximize the life of the replaceable battery used in the pH electrode. HALO pH probes can be used virtually anywhere: in the field, laboratory, or classroom. Their versatility and ease of use revolutionizes the way pH is measured.

The Bluetooth® word mark and logos are registered trademarks owned by Bluetooth SIG, Inc.



## One Press Connect

Connect to the Hanna Lab App at the press of a button via Bluetooth® wireless technology (10 m (33') range). The LED halo light indicates that the probe is active and transmitting.



## One Button Sample Tagging

Pressing the button on the HALO pH probe or the probe icon in the Hanna Lab App will tag sample data for easy reference.



## Easy to Replace Battery

The HALO's CR2032 lithium ion battery is easily replaced and lasts for approximately 500 hours.

The Bluetooth® word mark and logos are registered trademarks owned by Bluetooth SIG, Inc.

HI11312

# HALO®

Ideal for lab applications



Hanna Lab App  
Compatible

The Hanna Lab App is  
available on the App Store®  
and on Google Play.

Compatible with  
edge®blu

HI11312 HALO is an innovative, pH electrode with Bluetooth® Smart technology that allows a compatible Apple or Android smart device to be used as a pH meter. The electrode is a general purpose, glass body pH electrode ideal for routine laboratory measurement.

- **Glass body**
  - Non-porous surface that withstands harsh chemicals
- **Double junction**
  - Silver free outer reference that is compatible with most samples
- **Built-in temperature sensor**
  - High accuracy temperature compensated measurements
- **Refillable**
  - Allows the filling of the reference cell with electrolyte fill solution

## Glass Body

The glass body of the HI11312 is resistant to many harsh chemicals and is easy to clean making it ideal for general laboratory use.

## Double Junction

HI11312 is a double junction pH electrode in which the Ag/AgCl necessary for the reference cell is located behind an inner ceramic junction. The gel electrolyte between the inner and outer junction is silver free. This is important to prevent the precipitation of silver by Tris buffer, metals, and sulfides that would clog the junction leading to erratic readings.

## Built-in Temperature Sensor

HI11312 has a thermistor temperature sensor built into the tip of the pH electrode. A thermistor based temperature sensor provides for a high accuracy temperature reading while being in the tip of the electrode allows for a rapid determination of the temperature as it impacts the effect on the glass membrane potential.

## Refillable

HI11312 is a refillable pH electrode. Fill solution from the inside will diffuse through the ceramic junction as it is used and stored in storage solution. Electrolyte fill solution should be added to the probe when the level drops more than 1 cm (1/2") from the fill hole in order to maintain a good flow rate sustained by having adequate head pressure.

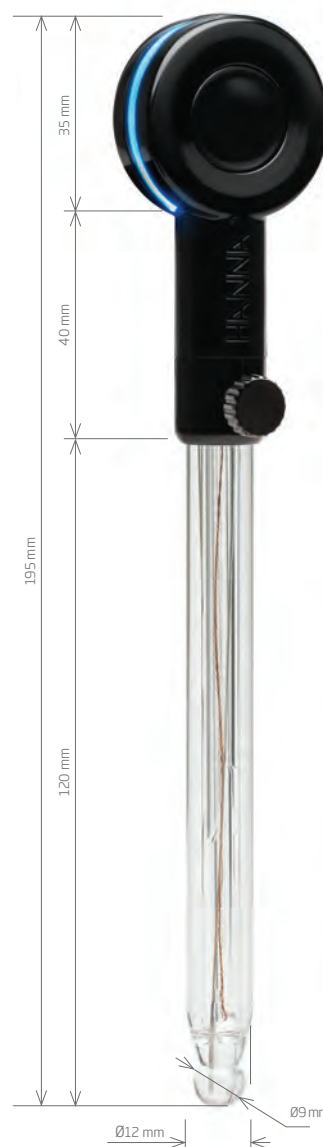

HALO Specifications	HI11312
Measurement Range	0.00 to 13.00 pH
Reference Cell Type	double, Ag/AgCl
Junction Type	ceramic
Electrolyte	3.5M KCl (refillable)
Body Material	glass
Tip / Shape	spheric
Temperature Operating Range	-5 to 80°C (23 to 176°F)
Glass Type	HT (high temperature)
Body Length/Overall Length	120 mm / 195 mm
Temperature Sensor	integrated
Outer Diameter	12 mm (glass)
Connector Type	Bluetooth Smart (Bluetooth 4.0), 10 m (33') range
Battery Type/Life	CR2032 3V lithium ion / approximately 500 hours
Environment	0 to 50°C (32 to 122°F); electronic module is not waterproof
<b>Ordering Information</b>	<b>HI11312</b> (HALO) is supplied with storage solution, cleaning solution, pH 7.01 buffer solution, pH 4.01 buffer solution, fill solution, battery, quality certificate, and instruction sheet.

App Store is a service mark of Apple Inc., Google Play and the Google Play logo are trademarks of Google LLC. The Bluetooth® word mark and logos are registered trademarks owned by Bluetooth SIG, Inc.

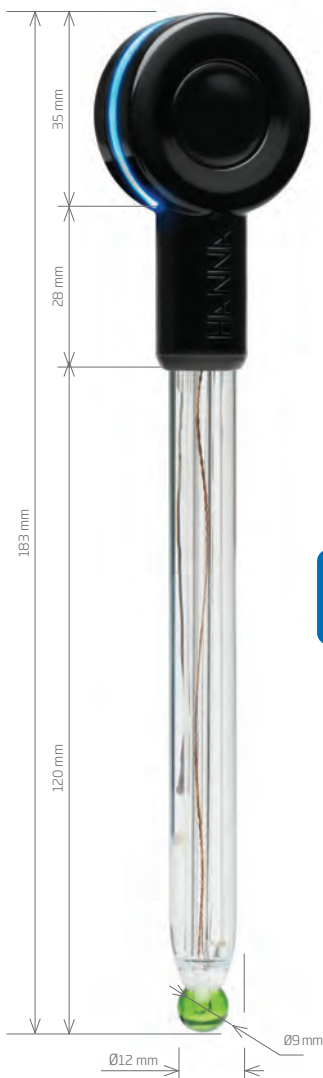

Also included with edge®blu

HI11102

**HALO**®



Hanna Lab App  
Compatible

The Hanna Lab App is available on the App Store® and on Google Play.

Compatible with edge®blu

Ideal for lab applications

HI11102 HALO is an innovative, pH electrode with Bluetooth® Smart technology that allows a compatible Apple or Android smart device to be used as a pH meter. This general purpose, glass body pH electrode is ideal for users that would prefer a laboratory pH electrode without the refill solution maintenance.

- **Glass body**
  - Non-porous surface that withstands harsh chemicals
- **Double junction**
  - Silver free outer reference that is compatible with most samples
- **Built-in temperature sensor**
  - High accuracy temperature compensated measurements
- **Gel-filled reference**
  - Maintenance free with no fill solutions required

### Glass Body

The glass body of the HI11102 is ideal for laboratory use and for users that prefer to have a traditional laboratory pH electrode without having to maintain the proper fill solution level. The glass is resistant to many harsh chemicals and is easy to clean.

### Double Junction

HI11102 is a double junction pH electrode in which the Ag/AgCl necessary for the reference cell is located behind an inner ceramic junction. The gel electrolyte between the inner and outer junction is silver free. This is important to prevent the precipitation of silver by Tris buffer, metals, and sulfides that would clog the junction leading to erratic readings.

### Built-in Temperature Sensor

HI11102 has a thermistor temperature sensor built into the tip of the pH electrode. A thermistor based temperature sensor provides for a high accuracy temperature reading while being in the tip of the electrode allows for a rapid determination of the temperature as it impacts the effect on the glass membrane potential.

### Maintenance Free Gel-filled Reference

HI11102 contains a silver free gel in the outer reference cell. There is no fill solution to replenish as the probe is used. Other than routine calibration and cleaning, this probe is maintenance free.

HALO Specifications	HI11102
Measurement Range	0.00 to 12.00 pH
Reference Cell Type	double, Ag/AgCl
Junction Type	ceramic
Electrolyte	gel
Body Material	glass
Tip / Shape	spheric
Temperature Operating Range	-5 to 80°C (23 to 176°F)
Glass Type	LT (low temperature)
Body Length/Overall Length	120 mm /183 mm
Temperature Sensor	integrated
Outer Diameter	12 mm (glass)
Connector Type	Bluetooth Smart (Bluetooth 4.0), 10 m (33') range
Battery Type/Life	CR2032 3V lithium ion / approximately 500 hours
Environment	0 to 50°C (32 to 122°F); electronic module is not waterproof
<b>Ordering Information</b>	<b>HI11102 (HALO)</b> is supplied with storage solution, cleaning solution, pH 7.01 buffer solution, pH 4.01 buffer solution, battery, quality certificate, and instruction sheet.

App Store is a service mark of Apple Inc., Google Play and the Google Play logo are trademarks of Google LLC. The Bluetooth® word mark and logos are registered trademarks owned by Bluetooth SIG, Inc.

HI13302

# HALO®

**Hanna Lab App  
Compatible**

 The Hanna Lab App is  
available on the App Store®  
and on Google Play.

 Compatible with  
edge®blu

**Ideal for test tube applications**

HI13302 HALO is an innovative, application specific, pH electrode with Bluetooth® Smart technology that allows a compatible Apple or Android smart device to be used as a pH meter. This electrode is designed for taking pH measurements in test tubes that are used by university, pharmaceutical, biotechnology, and food laboratories.

- **Small diameter bulb and body**
  - 5 mm diameter bulb fits easily into test tubes
- **Built-in temperature sensor**
  - Provides accurate temperature compensated pH measurements
- **Open junction**
  - Permits a predictable flow rate of reference electrolyte for stability
- **Gel-filled reference**
  - Maintenance free with no fill solutions required

### Small 5 mm Diameter Bulb and Body

HI13302 has a small pH-sensing bulb that is only 5 mm in diameter by 80 mm in length. The small diameter of the probe allows for pH measurements in test tubes, vials, and other small containers.

### Built-in Temperature Sensor

HI13302 has a thermistor temperature sensor built into the tip of the pH electrode. A thermistor based temperature sensor provides for high accuracy while being in the tip of the electrode allows for a rapid temperature compensated measurement.

### Open Junction Design

The reference half-cell has an open junction design in order to accommodate the 5 mm micro bulb and shaft. The open junction design is resistant to clogging from suspended solids and proteins found in biological samples. Any clogging that occurs will impede the measurement circuit between the indicating electrode and the internal reference resulting in slower response time and erratic readings.

### Maintenance Free Gel-filled Reference

The open junction design consists of a solid gel (Viscolene) interface between the sample and internal ceramic reference junction. Other than routine calibration and cleaning, this probe is maintenance free.

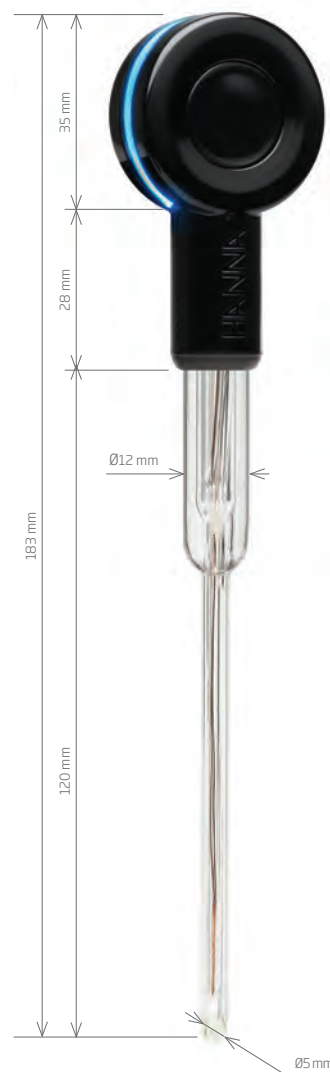

HALO Specifications	HI13302
Measurement Range	0.00 to 12.00 pH
Reference Cell Type	double, Ag/AgCl
Junction Type	open junction
Electrolyte	Viscolene
Body Material	glass
Tip / Shape	spheric
Temperature Operating Range	-5 to 50°C (23 to 122°F)
Glass Type	LT (low temperature)
Body Length/Overall Length	120 mm / 183 mm
Temperature Sensor	integrated
Outer Diameter	5 mm (glass)
Connector Type	Bluetooth Smart (Bluetooth 4.0), 10 m (33') range
Battery Type/Life	CR2032 3V lithium ion / approximately 500 hours
Environment	0 to 50°C (32 to 122°F); electronic module is not waterproof
<b>Ordering Information</b>	<b>HI13302</b> (HALO) is supplied with storage solution, cleaning solution, pH 7.01 buffer solution, pH 4.01 buffer solution, battery, quality certificate, and instruction sheet.

App Store is a service mark of Apple Inc., Google Play and the Google Play logo are trademarks of Google LLC. The Bluetooth® word mark and logos are registered trademarks owned by Bluetooth SIG, Inc.



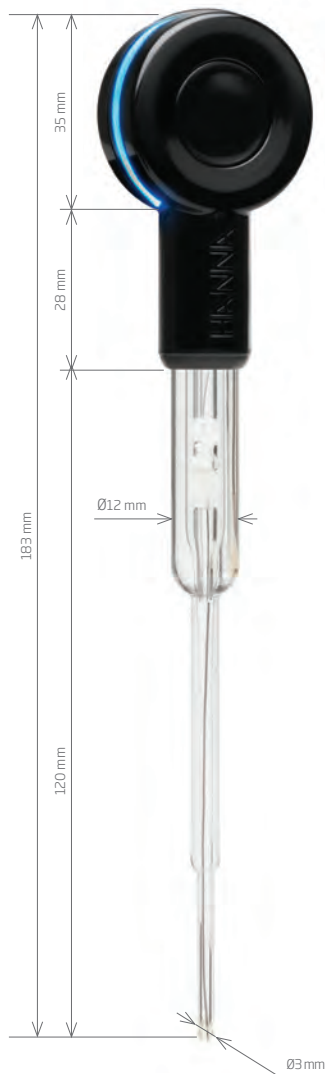

HI10832

**HALO**®



Hanna Lab App  
Compatible

The Hanna Lab App is  
available on the App Store®  
and on Google Play.

Compatible with  
edge@blu

Ideal for small sample  
lab applications

HI10832 HALO is an innovative, application specific, pH electrode with Bluetooth® Smart technology that allows a compatible Apple or Android smart device to be used as a pH meter. This pH electrode allows for the wireless measurement of very small sample sizes for laboratory customers in university, pharmaceutical, and biotechnology research.

- **Micro bulb tip**
  - The 3 mm diameter bulb can measure the pH in samples as small as 100 µL.
- **Open junction design**
  - Resists clogging and provides for fast response time
- **Gel-filled reference**
  - Maintenance free with no fill solutions required

### Micro Bulb Tip

HI10832 has an extremely small pH-sensing bulb that is only 3 mm in diameter. The small diameter of the probe allows for the measurement of pH in 96 well plates, test tubes, and vials. The HI10832 is ideal for use with expensive samples that offer little volume to work with.

### Open Junction Design

The reference half-cell has an open junction design in order to accommodate the 3 mm micro bulb and shaft. The open junction design is resistant to clogging from suspended solids and proteins found in biological samples. Any clogging that occurs will impede the measurement circuit between the indicating electrode and the internal reference resulting in slower response time and erratic readings.

### Maintenance Free Gel-filled Reference

The open junction design consists of a solid gel (viscolene) interface between the sample and internal ceramic reference junction. Other than routine calibration and cleaning, this probe is maintenance free.

HALO Specifications	HI10832
Measurement Range	0.00 to 12.00 pH
Reference Cell Type	double, Ag/AgCl
Junction Type	open
Electrolyte	Viscolene
Body Material	glass
Tip / Shape	spheric
Temperature Operating Range	0 to 50°C (32 to 122°F)
Glass Type	GP (general purpose)
Body Length/Overall Length	120 mm /183 mm
Temperature Sensor	none
Outer Diameter	3 mm (glass)
Connector Type	Bluetooth Smart (Bluetooth 4.0), 10 m (33') range
Battery Type/Life	CR2032 3V lithium ion / approximately 500 hours
Environment	0 to 50°C (32 to 122°F); electronic module is not waterproof

### Ordering Information

**HI10832** (HALO) is supplied with storage solution, cleaning solution, pH 7.01 buffer solution, pH 4.01 buffer solution, battery, quality certificate, and instruction sheet.

App Store is a service mark of Apple Inc., Google Play and the Google Play logo are trademarks of Google LLC. The Bluetooth® word mark and logos are registered trademarks owned by Bluetooth SIG, Inc.

HI12302

# HALO®

Ideal for field applications



Hanna Lab App  
Compatible

The Hanna Lab App is  
available on the App Store®  
and on Google Play.

Compatible with  
edge®blu

HI12302 HALO is an innovative, pH electrode with Bluetooth® Smart technology that allows a compatible Apple or Android smart device to be used as a pH meter. HI12302 is a general purpose, PEI plastic body pH electrode for routine measurements in the field, lab, or at home.

- **PEI plastic body**
  - Durable, chemically resistant plastic
- **Double Junction**
  - Silver free outer reference that is compatible with most samples
- **Built-in temperature sensor**
  - High accuracy temperature compensated measurements
- **Gel-filled reference**
  - Maintenance free with no fill solutions required

## PEI Plastic Body

The body of the HI12302 is composed of polyetherimide (PEI) resin. PEI is a high quality plastic that is chemically resistant to many aggressive chemicals making it ideal for a wide range of applications. The PEI body excels in field measurements due to its durability. The shield around the spherical glass tip also helps to minimize breakage due to accidental bumping or dropping of the electrode.

## Double Junction

HI12302 is a double junction pH electrode in which the Ag/AgCl necessary for the reference cell is located behind an inner ceramic junction. The electrolyte between the inner and outer junction is silver free. This is important to prevent the precipitation of silver by Tris buffer, metals, and sulfides that would clog the junction leading to erratic readings.

## Built-in Temperature Sensor

A thermistor temperature sensor is built into the tip of the pH electrode. A thermistor based temperature sensor provides for a high accuracy temperature reading while being in the tip of the electrode allows for a rapid determination of the temperature as it impacts the effect on the glass membrane potential.

## Maintenance Free Gel-filled Reference

HI12302 contains a silver free gel in the outer reference cell. There is no fill solution to replenish as the probe is used. Other than routine calibration and cleaning, this probe is maintenance free.

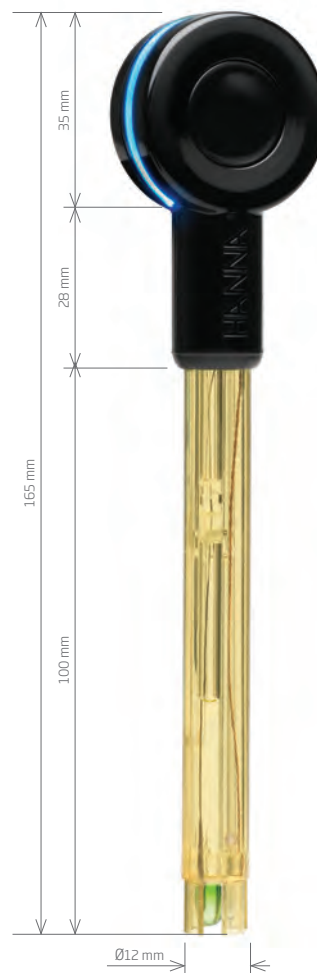

### HALO Specifications

### HI12302

Measurement Range	0.00 to 12.00 pH
Reference Cell Type	double, Ag/AgCl
Junction Type	ceramic
Electrolyte	gel
Body Material	PEI
Tip / Shape	dome
Temperature Operating Range	-5 to 70°C (23 to 158°F)
Glass Type	LT (low temperature)
Body Length/Overall Length	100 mm / 165 mm
Temperature Sensor	integrated
Outer Diameter	12 mm (plastic)
Connector Type	Bluetooth Smart (Bluetooth 4.0), 10 m (33') range
Battery Type/Life	CR2032 3V lithium ion / approximately 500 hours
Environment	0 to 50°C (32 to 122°F); electronic module is not waterproof

### Ordering Information

**HI12302** (HALO) is supplied with storage solution, cleaning solution, pH 7.01 buffer solution, pH 4.01 buffer solution, battery, quality certificate, and instruction sheet.

App Store is a service mark of Apple Inc., Google Play and the Google Play logo are trademarks of Google LLC. The Bluetooth® word mark and logos are registered trademarks owned by Bluetooth SIG, Inc.

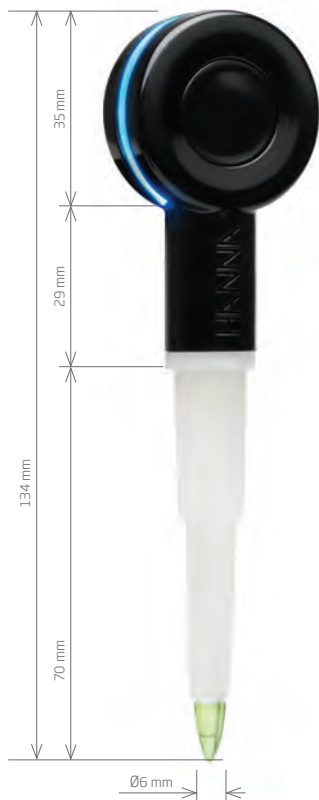

FC2022

**HALO**®



Hanna Lab App  
Compatible

The Hanna Lab App is  
available on the App Store®  
and on Google Play.

Compatible with  
edge@blu

Ideal for food applications

The FC2022 HALO is an innovative, application specific pH electrode with Bluetooth® Smart technology designed for food processing companies that need to monitor the pH of their product for quality and compliance.

- **Conic bulb**
  - Easy penetration into soft solids and semi-solids
- **Low temperature glass**
  - Fast and accurate measurement of refrigerated products
- **Open junction**
  - Resists clogging and provides fast response time
- **Gel-filled reference**
  - Maintenance free with no fill solutions required
- **Built-in temperature sensor**
  - High accuracy temperature compensated measurements

### Conic Bulb

The conical shaped tip design allows for the easy penetration of the sensor into soft solids and semi-solids such as cheeses, yogurt, meats, and sauces. It doesn't trap foods and is very easy to wipe clean.

### Low Temperature Glass

The glass tip is made with Low Temperature (LT) glass formulation that has a lower resistance than standard glass types used with ordinary pH electrodes. This is beneficial since many food products are stored at low temperatures. FC2022 HALO is suitable to be used for measurements between 0 to 10°C (32 to 50°F).

### Open Junction Design

The open junction design consists of a solid gel (viscolene) interface between the sample and internal reference. This interface not only prevents silver from entering the sample, but also makes it impermeable to clogging from food products, maintaining a fast response and stable reading.

### Maintenance Free Gel-filled Reference

Because the internal reference is gel, there is no fill solution to replenish as the probe is used. Other than routine calibration and cleaning, this a maintenance free probe.

### Built-in Temperature Sensor

The thermistor temperature sensor is built into the tip of the pH electrode. A thermistor based temperature sensor provides for a high accuracy temperature while being in the tip of the electrode allows for a rapid temperature compensated measurement.

HALO Specifications	FC2022
Measurement Range	0.00 to 12.00 pH
Reference Cell Type	double, Ag/AgCl
Junction Type	open
Electrolyte	Viscolene
Body Material	PVDF
Tip / Shape	conic
Temperature Operating Range	0 to 60°C (32 to 140°F)
Glass Type	LT (low temperature)
Body Length/Overall Length	70 mm / 134 mm
Temperature Sensor	integrated
Outer Diameter	12 mm to 8 mm taper (plastic)
Connector Type	Bluetooth Smart (Bluetooth 4.0), 10 m (33') range
Battery Type/Life	CR2032 3V lithium ion / approximately 500 hours
Environment	0 to 50°C (32 to 122°F); electronic module is not waterproof
<b>Ordering Information</b>	<b>FC2022 (HALO)</b> is supplied with storage solution, cleaning solution, pH 7.01 buffer solution, pH 4.01 buffer solution, battery, quality certificate, and instruction sheet.

App Store is a service mark of Apple Inc., Google Play and the Google Play logo are trademarks of Google LLC. The Bluetooth® word mark and logos are registered trademarks owned by Bluetooth SIG, Inc.

## The Importance of pH in Wine Making

The pH of wine is important to determine because it will affect the quality of the final product in terms of taste, color, oxidation, chemical stability, and other factors. Generally in winemaking, the higher the pH reading, the lower the amount of acidity in the wine. Three important factors in determining the pH of wine include the ratio of malic acid to tartaric acid, the amount of potassium, and the total amount of acid present.

Most wines optimally have a pH between 2.9 and 4.0, with values differing based on the type of wine. Values above pH 4.0 indicate that the wine may spoil quickly and be chemically unstable. Lower pH values allow the wine to stay fresher for a longer period and retain its original color and flavor. High pH wine is more likely to breed bacteria and become unsuitable to drink. For finished white wines, the ideal pH is between pH 3.00 and pH 3.30, while the final pH for red wine is ideally between pH 3.40 and pH 3.50. The optimal pH before the fermentation process is between pH 2.9 and pH 4.0. The pH of wine therefore not only affects the color of wine, but also the oxidation, yeast fermentation, protein stability, and bacteria growth and fermentation.

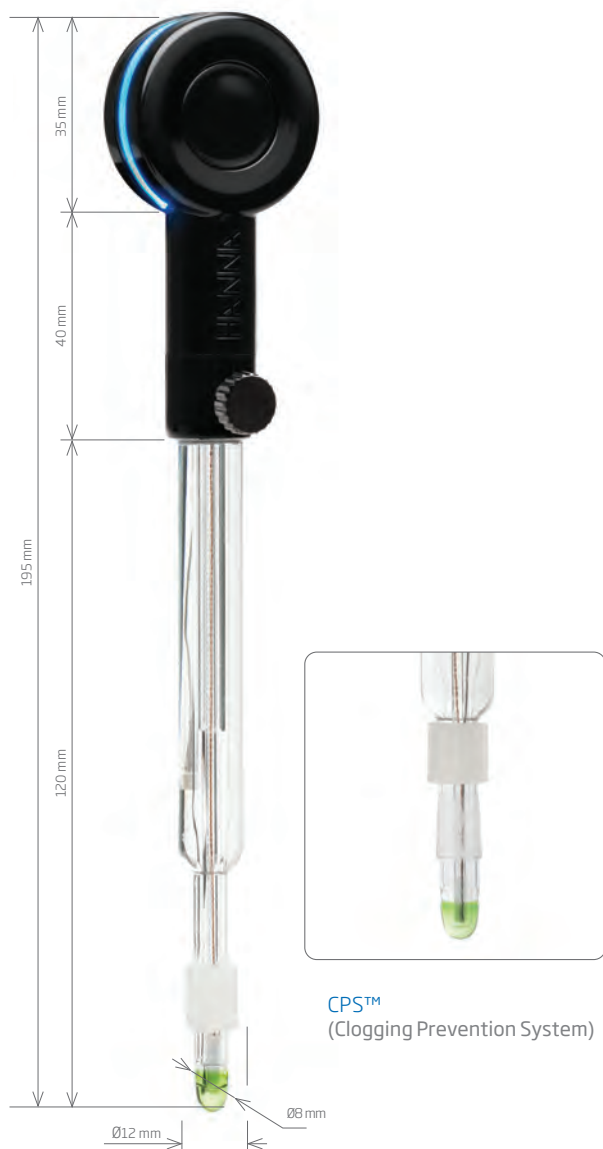

HI10482

**HALO**®



Hanna Lab App  
Compatible

The Hanna Lab App is  
available on the App Store®  
and on Google Play.

Compatible with  
edge@blu

Ideal for wine, must and juice

HI10482 HALO is an innovative, application specific pH electrode designed for the winemaker that needs to monitor the pH of wine, grape juice, and must.

- **Clogging prevention system (CPS) technology**
  - Anti-clogging PE sleeve that maintains stability and fast response
- **Refillable**
  - Allows the filling of the reference cell with electrolyte fill solution
- **Built-in temperature sensor**
  - High accuracy temperature compensated measurements
- **Customized calibration buffer value**
  - Calibration to pH 3.00 to bracket the expected reading in wine

### Clogging Prevention System (CPS) Technology

CPS technology is an innovation for the improvement of pH measurements in wine juice and must samples that have high solids content. Conventional pH electrodes use ceramic junctions that can clog quickly from solids found in juice and must. When the junction is clogged, the electrode does not function properly and erratic readings can result. CPS technology utilizes a ground glass junction coupled with a movable PE sleeve to prevent clogging. The ground glass allows proper flow of the liquid, while the PE sleeve repels solids. As a result, pH electrodes with CPS technology take up to 20 times longer to be fouled as compared to conventional electrodes. When the electrode becomes fouled the PE sleeve can be moved to clean the ground glass surface rejuvenating the junction and extending probe life.

### Refillable

HI10482 is a refillable double junction pH electrode. Fill solution from inside the probe will diffuse through the ground glass junction while it is in use and when it is stored in storage solution. Electrolyte fill solution should be added to the probe when the level drops more than 1 cm (.39") from the fill hole in order to maintain a good flow rate sustained by having adequate head pressure.

### Built-in Temperature Sensor

HI10482 has a built-in thermistor temperature sensor that is in the tip of the pH electrode. A thermistor temperature sensor provides a high accuracy temperature reading and should be as close as possible to the indicating pH electrode in order to compensate for the effect that temperature has on the membrane potential. Having a built in temperature sensor is important in wine since the measured pH values are more than 3 pH units away from the isopotential point. The further away from the isopotential point the greater the influence that temperature has on the observed reading.

### Customized Calibration Buffer Value

The average pH of wine influences the choice of calibration buffers that should be used. Generally, most wines have a finished pH between 3 and 4. To ensure a high accuracy measurement, the HI10482 will prompt for pH 3.00 buffer in place of pH 4.01. This allows the calibration to bracket the expected value to be measured.

HALO Specifications	HI10482
Measurement Range	0.00 to 12.00 pH
Reference Cell Type	double, Ag/AgCl
Junction Type	movable open junction
Electrolyte	3.5M KCl (refillable)
Body Material	glass
Tip / Shape	dome
Temperature Operating Range	0 to 60°C (32 to 140°F)
Glass Type	LT (low temperature)
Body Length/Overall Length	120 mm / 195 mm
Temperature Sensor	integrated
Outer Diameter	12 mm (glass)
Connector Type	Bluetooth Smart (Bluetooth 4.0), 10 m (33') range
Battery Type/Life	CR2032 3V lithium ion / approximately 500 hours
Environment	0 to 50°C (32 to 122°F); electronic module is not waterproof

### Ordering Information

**HI10482** (HALO) is supplied with storage solution, cleaning solution, pH 7.01 buffer solution, pH 3.00 buffer solution, fill solution, battery, quality certificate, and instruction sheet.

App Store is a service mark of Apple Inc., Google Play and the Google Play logo are trademarks of Google LLC. The Bluetooth® word mark and logos are registered trademarks owned by Bluetooth SIG, Inc.

## pH in Beer

In the brewing process, the enzymes required to convert the starch into sugar are pH-sensitive with an optimal pH range between 5.2 pH and 5.6 pH. Different compounds are used to adjust the pH including phosphoric acid, lactic acid, and gypsum.

Wort clarity and break formation are also affected by pH. Protein coagulation occurs during wort boiling, where the optimum pH is around 4.9, even though a common boil pH is 5.2. A pH that is too high will not only inhibit coagulation but also promote browning due to the interaction of amino acids and reducing sugars.

Hop utilization during the wort boil is also affected by pH. As pH increases, the solubility of hop resins increases. Unfortunately for hop lovers, a high pH also increases the release of tannins resulting in a harsher taste. Higher pH also favors elevated microbial activity.

As a living catalyst, yeast maintains a pH around 6.5 within its cells; however, the preference is to inhabit a more acidic environment. During the fermentation stage, the pH should be lower to accommodate the yeast and also to ensure microbial stability and consistent flavoring of the beer; an optimal pH range during fermentation is between pH 4.1 and 4.3.

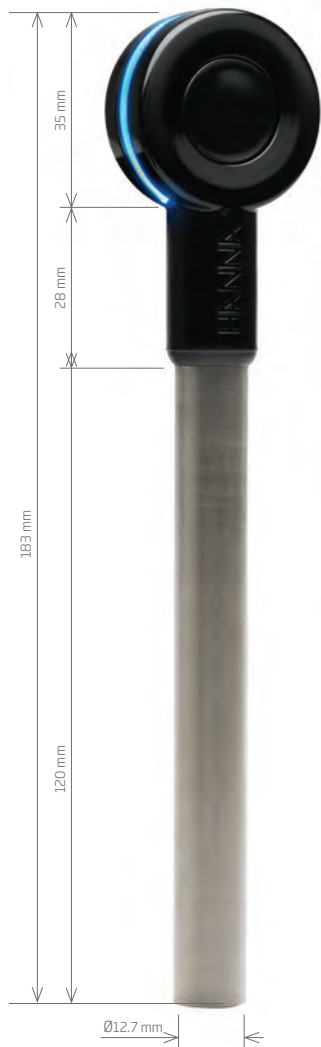

FC2142

**HALO**®



Hanna Lab App  
Compatible

The Hanna Lab App is  
available on the App Store®  
and on Google Play.

Compatible with  
edge@blu

Ideal for brewers

FC2142 HALO is an innovative, application specific pH electrode designed for brewers to help monitor the pH of mash and wort.

- **Built-in temperature sensor**
  - High accuracy temperature compensated measurements
- **Titanium body**
  - Provides protection even at high temperatures as well as stability of measurement

### Built-in Temperature Sensor

FC2142 has a thermistor temperature sensor built into the tip of the pH electrode to provide highly accurate temperature readings and temperature compensated pH measurements.

### Titanium Body

A pH measurement is a high impedance measurement, and as such is susceptible to interference from electrical noise and humidity. To overcome these issues a titanium body serves as a matching pin. A matching pin is a differential measurement technique used to eliminate electrical noise in the measurement system. The titanium body, being made of metal, is virtually unbreakable and offers additional protection from accidental breakage.



HALO Specifications	FC2142
Measurement Range	0.00 to 13.00 pH
Reference Cell Type	double, Ag/AgCl
Junction Type	cloth
Electrolyte	gel
Body Material	titanium
Tip / Shape	flat
Temperature Operating Range	0 to 80°C (32 to 176°F)
Glass Type	LT (low temperature)
Body Length/Overall Length	120 mm / 183 mm
Temperature Sensor	integrated
Outer Diameter	12.7 mm (titanium)
Connector Type	Bluetooth Smart (Bluetooth 4.0), 10 m (33') range
Battery Type/Life	CR2032 3V lithium ion / approximately 500 hours
Environment	0 to 50°C (32 to 122°F); electronic module is not waterproof
<b>Ordering Information</b>	<b>FC2142 (HALO)</b> is supplied with storage solution, cleaning solution, pH 7.01 buffer solution, pH 4.01 buffer solution, battery, quality certificate, and instruction sheet.

App Store is a service mark of Apple Inc., Google Play and the Google Play logo are trademarks of Google LLC. The Bluetooth® word mark and logos are registered trademarks owned by Bluetooth SIG, Inc.

## pH Measurements

pH is the measurement of hydrogen ion concentration (H<sup>+</sup>) in water or soil. A pH of 7 is considered neutral. A pH below 7 is considered more acidic and a pH above 7 is considered more basic or alkaline. Water pH is important for plant management because it affects the solubility of fertilizers and the effectiveness of insecticides and fungicides.

Below is a pH scale that ranges from 0 - 14 pH. Most plants have an optimal pH between 5.8 and 6.4 pH in soil-less media. For direct soil applications, a typical pH range of 6.5 - 7.0 pH is more common.

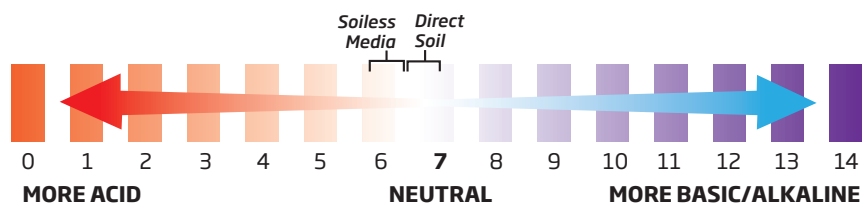

### Pounds of Sulfur to Lower the Soil pH per 100 sq. ft.

Present pH	Desired pH				
	6.5	6.0	5.5	5.0	4.5
	lbs. to add				
8.0	3.0	4.0	5.5	7.0	8.0
7.5	2.0	3.5	4.5	6.0	7.0
7.0	1.0	2.0	3.5	5.0	6.0
6.5		1.0	2.5	4.0	4.5
6.0			1.0	2.5	3.5

Increase amount by 1/2 for clay soil, reduce amount by 1/3 for sandy soil, multiply by 6 if aluminum sulfate is used

### Pounds of Lime to Raise the Soil pH

pH Value from Soil Test	Amount of Lime to Add/1,000 sq. ft.
Below 5.0	100 lb. agricultural lime
5.0-6.0	50 lb. agricultural lime
Above 6.0	Do not use lime



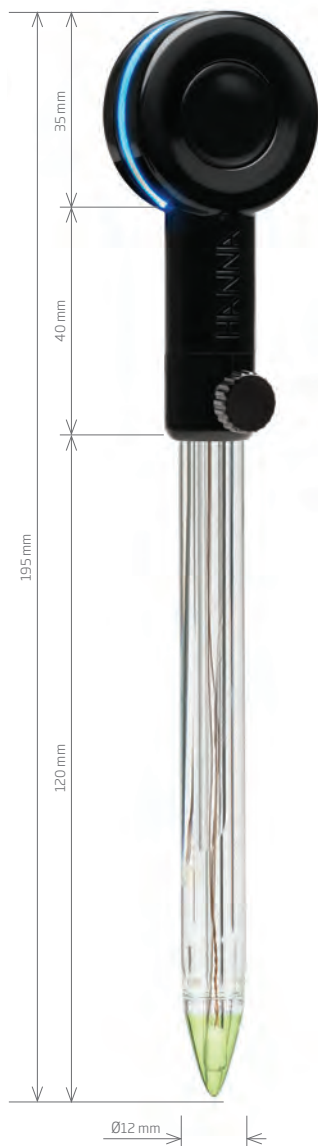

HI12922

**HALO**®



Hanna Lab App  
Compatible

The Hanna Lab App is  
available on the App Store®  
and on Google Play.

Compatible with  
edge@blu

Ideal for direct soil applications

The HI12922 HALO is an innovative, application specific pH electrode with Bluetooth® Smart technology that allows a compatible Apple or Android smart device to be used as a pH meter. This electrode is designed for agricultural, hydroponics, and greenhouse growers that need to monitor the pH of soil and soilless media in order to optimize plant growth.

- **Conic bulb**
  - Easy penetration into soft solids and semi-solids
- **Triple ceramic junction**
  - High flow rate for fast and stable response in slightly hydrated media
- **Refillable**
  - Allows the filling of the reference cell with electrolyte fill solution
- **Built-in temperature sensor**
  - High accuracy temperature compensated measurements

### Conic Bulb

The conical shaped tip design allows for the easy penetration of the sensor into soft solids and semi-solids such as soil and soilless media. Soilless media includes hydroponics growing media including rockwool, coconut coir, and perlite.

### Triple Ceramic Junction

The refillable HI12922 has three ceramic junctions in the reference cell. All pH electrodes have a reference junction that provides continuity between the internal reference wire and the sample. Utilizing a triple ceramic junction design allows for a higher flow rate of fill solution which helps provide for a fast and stable response in damp soil and soilless media.

### Refillable

HI12922 is a refillable pH electrode. Fill solution from the inside will diffuse through the ceramic junctions as it is used and while stored in storage solution. Electrolyte fill solution should be added to the probe when the level drops more than 1 cm (1/2") from the fill hole in order to maintain a good flow rate sustained by having adequate head pressure (optional).

### Built-in Temperature Sensor

The HI12922 has a thermistor temperature sensor built into the tip of the pH electrode. A thermistor based temperature sensor provides high accuracy while being in the tip of the electrode allows for a rapid temperature compensated measurement.

HALO Specifications	HI12922
Measurement Range	0.00 to 12.00 pH
Reference Cell Type	double, Ag/AgCl
Junction Type	triple ceramic
Electrolyte	3.5M KCl (refillable)
Body Material	glass
Tip / Shape	conic
Temperature Operating Range	-5 to 70°C (23 to 158°F)
Glass Type	LT (low temperature)
Body Length/Overall Length	120 mm / 195 mm
Temperature Sensor	integrated
Outer Diameter	12 mm (glass)
Connector Type	Bluetooth Smart (Bluetooth 4.0), 10 m (33') range
Battery Type/Life	CR2032 3V lithium ion / approximately 500 hours
Environment	0 to 50°C (32 to 122°F); electronic module is not waterproof

### Ordering Information

**HI12922** (HALO) is supplied with HI7121319 soil auger, storage solution, cleaning solution, pH 7.01 buffer solution, pH 4.01 buffer solution, fill solution, battery, quality certificate, and instruction sheet.

Includes soil auger



App Store is a service mark of Apple Inc., Google Play and the Google Play logo are trademarks of Google LLC. The Bluetooth® word mark and logos are registered trademarks owned by Bluetooth SIG, Inc.

HI14142

# HALO®

Ideal for flat surfaces



Hanna Lab App  
Compatible

The Hanna Lab App is  
available on the App Store®  
and on Google Play.

Compatible with  
edge®blu

The HI14142 HALO is an innovative pH electrode with Bluetooth® Smart technology designed for flat surfaces.

- **Flat bulb**
  - Measure pH on flat surfaces or small volume samples
- **Low temperature glass**
  - Fast and accurate measurement at lower temperatures
- **Open junction**
  - Resists clogging and provides fast response time
- **Gel-filled reference**
  - Maintenance free with no fill solutions required
- **Built-in temperature sensor**
  - High accuracy temperature compensated measurements

## Flat Tip Bulb

The flat shaped tip design allows for easy measurement on surfaces or samples with a small volume.

## Low Temperature Glass

The glass tip is made with Low Temperature (LT) glass formulation that has a lower resistance than standard glass types used with ordinary pH electrodes.

## Open Junction Design

The open junction design consists of a solid gel (viscolene) interface between the sample and internal reference. This interface not only prevents silver from entering the sample, but also makes it impermeable to clogging from food products, maintaining a fast response and stable reading.

## Maintenance Free Gel-filled Reference

Because the internal reference is gel, there is no fill solution to replenish as the probe is used. Other than routine calibration and cleaning, this a maintenance free probe.

## Built-in Temperature Sensor

The thermistor temperature sensor built into the tip of the pH electrode. A thermistor based temperature sensor provides high accuracy while being in the tip of the electrode allows for a rapid temperature compensated measurement.

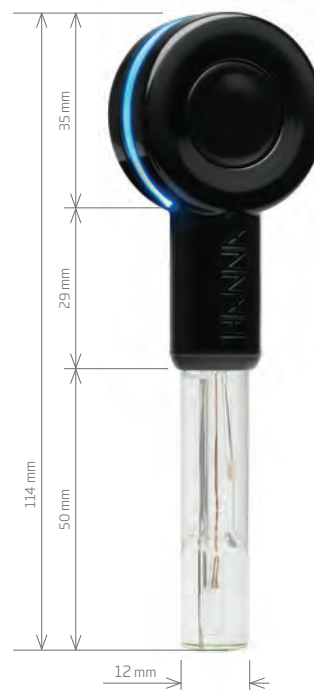

HALO Specifications	HI14142
Measurement Range	0.00 to 12.00 pH
Reference Cell Type	double, Ag/AgCl
Junction Type	open
Electrolyte	Viscolene
Body Material	glass
Tip / Shape	flat
Temperature Operating Range	0 to 50°C (32 to 122°F)
Glass Type	LT (low temperature)
Body Length/Overall Length	50 mm / 114 mm
Temperature Sensor	integrated
Outer Diameter	12 mm (glass)
Connector Type	Bluetooth Smart (Bluetooth 4.0), 10 m (33') range
Battery Type/Life	CR2032 3V lithium ion / approximately 500 hours
Environment	0 to 50°C (32 to 122°F); electronic module is not waterproof
<b>Ordering Information</b>	<b>HI14142</b> (HALO) is supplied with storage solution, cleaning solution, pH 7.01 buffer solution, pH 4.01 buffer solution, battery, quality certificate, and instruction sheet.

App Store is a service mark of Apple Inc., Google Play and the Google Play logo are trademarks of Google LLC. The Bluetooth® word mark and logos are registered trademarks owned by Bluetooth SIG, Inc.

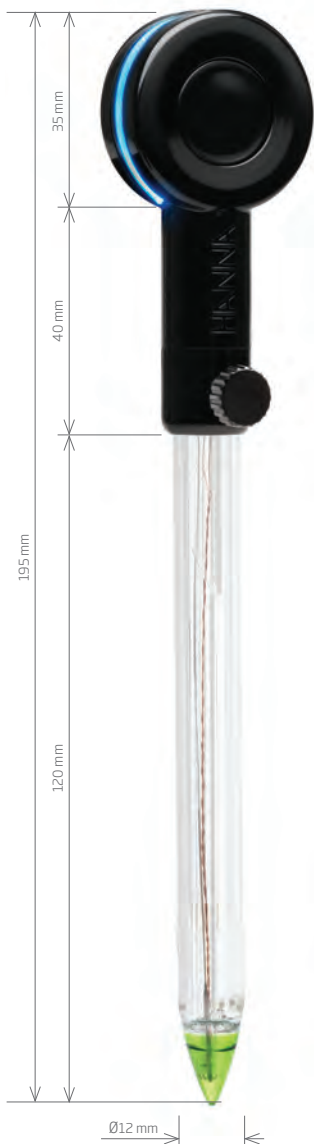

HI10532

**HALO**®



Hanna Lab App  
Compatible

The Hanna Lab App is  
available on the App Store®  
and on Google Play.

Compatible with  
edge®blu

Ideal for food applications

The HI10532 HALO is a Bluetooth pH electrode that turns a smart device into a fully functional pH meter for measuring the pH of food products. The HI10532 features a conic shaped sensing tip along with a triple ceramic junction in the outer reference for stable and reliable measurements in samples that would be a challenge for standard pH electrode designs.

- **Bluetooth® Smart Connectivity**
  - Connects to smart devices such as phones and tablets
- **Conic bulb**
  - Easy penetration into soft solids and semi-solids
- **Triple ceramic junction**
  - High flow rate for fast and stable response
- **Refillable**
  - Allows the filling of the reference cell with electrolyte fill solution
- **Built-in temperature sensor**
  - High accuracy temperature compensated measurements

### Low Temperature Glass

Low Temperature (LT) glass allows the probe to be used from -5 to 70°C (23 to 158°F)

### Conical Glass Tip

The conical shaped tip design allows for penetration into solids, semi-solids, and emulsions and is ideal for the direct measurement of pH in food products

### Triple Ceramic Junction

The triple ceramic junction allows a higher flow rate of electrolyte from the reference cell into the measurement sample. The increased flow provides greater continuity between the reference electrode and the sample making ideal for slurries and low conductivity samples

### Refillable

HI10532 is a refillable pH electrode. Fill solution from the inside will diffuse through the ceramic junctions as it is used and while stored in storage solution. Electrolyte fill solution should be added to the probe when the level drops more than 1 cm (1/2") from the fill hole in order to maintain a good flow rate sustained by having adequate head pressure (optional).

### Built-in Temperature Sensor

The temperature reading is necessary in order to compensate for temperature variations that affect the electrode response.

#### HALO Specifications

#### HI10532

Measurement Range	0 to 12 pH (resolution displayed by device selectable up to 0.001pH)
Reference Cell Type	double, Ag/AgCl
Junction / Flow Rate	triple ceramic / 40 to 50 µL/h
Electrolyte	3.5M KCl (refillable)
Body Material	glass
Tip / Shape	conic
Temperature Operating Range	-5 to 70°C (23 to 158°F)
Glass Type	LT (low temperature)
Body Length/Overall Length	120 mm / 195 mm
Outer Diameter	12 mm (glass)
Temperature Sensor	yes
Amplifier	yes
Connector Type	Bluetooth Smart (Bluetooth 4.0), 10 m (33') range
Battery Type/Life	CR2032 3V lithium ion / approximately 500 hours
Environment	0 to 50°C (32 to 122°F); electronic module is not waterproof

**HI10532 (HALO)** is supplied with pH 7.01 buffer solution sachets (2), pH 4.01 buffer solution sachets (2), electrode cleaning solution sachets (2), storage solution (30 mL), refill electrolyte solution (30 mL), refilling pipette, battery, electrode quality testing certificate, and instruction manual.

#### Ordering Information

App Store is a service mark of Apple Inc., Google Play and the Google Play logo are trademarks of Google LLC. The Bluetooth® word mark and logos are registered trademarks owned by Bluetooth SIG, Inc.



## Hanna Lab App

The Hanna Lab App is available on the App Store® and on Google Play.



The first app that turns a smart phone or tablet into a full-featured pH meter.

The Hanna Lab App turns a compatible smart phone or tablet into a full-featured pH meter when used with compatible Hanna electrodes with Bluetooth® wireless technology. Functions include calibration, measurement and data logging (at one second intervals), graphing, and data sharing. Measurements can be displayed alone, with tabulated data, or as a graph. The graph can be panned and zoomed with pinch-to-zoom technology.

# Measurement Screen

## Name, Battery Status, and Electrode Condition on Display

The measurement screen of the Hanna Lab App displays the name, battery life and condition of the probe.

## Real-Time Data

Displays updated pH and temperature every second.



## Just the Essentials

Basic view provides measurement information in a clean, straightforward manner.

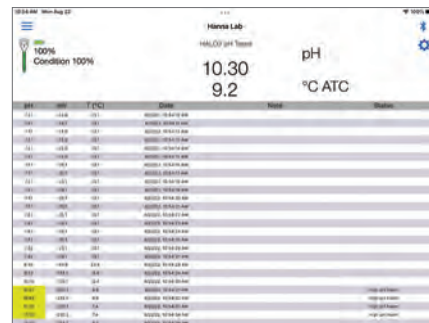

## All Information on Display

Table view displays measurement, time and date, annotations, and alarm status in a continuously updated table.

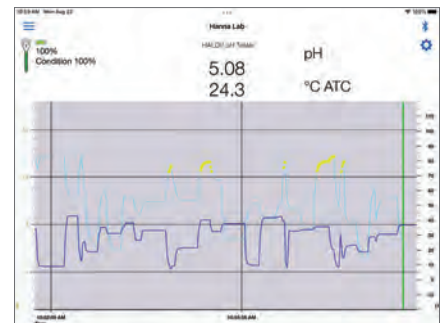

## Fluid, Dynamic Graphing

Graph view provides measurement information linearly. Graph axes may be expanded using pinch-to-zoom technology for enhanced viewing.



## Data Logging

Date	pH	mV	T (°C)
8/22/22, 10:44:30 AM	9.97	-24.8	33.1
8/22/22, 10:44:29 AM	9.97	-24.7	33.1
8/22/22, 10:44:28 AM	9.97	-24.8	33.1
8/22/22, 10:44:27 AM	9.97	-24.9	33.1
8/22/22, 10:44:26 AM	9.97	-25.0	33.1
8/22/22, 10:44:25 AM	9.97	-25.1	33.1
8/22/22, 10:44:24 AM	9.97	-25.1	33.1
8/22/22, 10:44:23 AM	9.97	-25.1	33.1
8/22/22, 10:44:22 AM	9.97	-25.1	33.1
8/22/22, 10:44:21 AM	9.97	-25.1	33.1
8/22/22, 10:44:20 AM	9.97	-25.1	33.1
8/22/22, 10:44:19 AM	9.97	-25.1	33.1
8/22/22, 10:44:18 AM	9.97	-25.1	33.1
8/22/22, 10:44:17 AM	9.97	-25.1	33.1
8/22/22, 10:44:16 AM	9.97	-25.1	33.1
8/22/22, 10:44:15 AM	9.97	-25.1	33.1
8/22/22, 10:44:14 AM	9.97	-24.8	33.1
8/22/22, 10:44:13 AM	9.97	-24.7	33.1
8/22/22, 10:44:12 AM	9.97	-24.8	33.1
8/22/22, 10:44:11 AM	9.97	-24.6	33.1

Export Data Options:

- Share via Email
- PDF
- CSV



### Data-logging

Data is automatically saved every hour. There are four ways to save and share data: all data since last auto save, annotations only, all data within a timed interval, and annotations within a timed interval.

### Export Data

Saved data may be shared via email in PDF or CSV format.

### Custom Annotations

Saved data points may be annotated with measurement specific information.

## GLP (Good Laboratory Practice)



### Basic GLP

Displays date and time of current calibration along with probe offset and average slope. For tablet displays, basic GLP can be also displayed in table and graph views.



### Full GLP

Displays date and time of current calibration, probe offset, and average slope along with calibrated buffers, mV values, temperature and slopes between each buffer. For tablet displays, full GLP can be also displayed in table and graph views.

#### Hanna Lab App Specifications\*

Range**	-2.000 to 16.000 pH ±800 mV -20.0 to 120.0°C (-4.0 to 248.0°F)
Resolution	0.1; 0.01; 0.001 pH 1; 0.1 mV; 0.1 °C (0.1°F)
Accuracy (@25°C/77°F)	±0.005 pH ±0.3 mV ±0.5 °C (±1.0°F)
Calibration Points	up to five-point calibration with seven standard buffers (1.68, 3.00 (HI10482, HI981033, HI9810332 only) or 4.01, 6.86, 7.01, 9.18, 10.01, 12.45 pH)
Temperature Compensation**	automatic from -5.0 to 100.0°C – 23.0 to 212.0°F
Compatibility/System Requirements	see <a href="http://www.hannainst.com">www.hannainst.com</a> for latest compatibility requirements

#### Download Information



\* \* Limits will be reduced to actual probe/sensor limits.

App Store® is a service mark of Apple Inc., Google Play and the Google Play logo are trademarks of Google LLC. The Bluetooth® word mark and logos are registered trademarks owned by Bluetooth SIG, Inc.

## Calibration



### Clear and Concise Calibration Screens

The Hanna Lab App allows for calibration of up to five points. The buffer value is automatically detected and temperature corrected to 25.0°C (77°F) during calibration.



### Calibration Reminder

Alerts users when calibration is needed.

## Additional Features



### Measurement Alerts

Readings that exceed user-defined alarm thresholds are highlighted in yellow on the measurement screen, graph, and table. Readings that exceed the probe specifications are highlighted in red.



### Settings

Tap the gear icon in the top right corner of the measurement screen to access the Settings menu.



### Help and Tutorials

The Hanna Lab App features demo probe mode, general app information, general information, pH tutorial, maintenance tutorial, and contact information.

HI98199

## pH • EC • DO Waterproof Meter

Use three professional probes with Hanna's Quick Connect

The HI98199 is a versatile meter that can monitor pH, EC, and dissolved oxygen when paired with the respective probe. Hanna's pH probe is included with the HI98199 and the EC and DO probes can be ordered separately. Each digital probe features Hanna's Quick Connect DIN connector and the included carrying case contains all the accessories necessary to start taking pH measurements.

### Backlit Graphic LCD Display

The HI98199 features a backlit graphic LCD with on-screen help and the capability to display multiple parameters simultaneously. The use of virtual keys provides for an intuitive user interface.

### Waterproof Protection

HI98199 is enclosed in an IP67 rated waterproof casing and can withstand immersion in water at a depth of 1 m for up to 30 minutes. The probes feature an IP68 rating for continuous immersion in water.

### Quick Connect Digital Probe

pH, EC, and DO probes feature a Quick Connect DIN connector that makes a waterproof connection with the meter.

### Auto-sensor Recognition

The probe and meter automatically recognize the sensors that are connected.

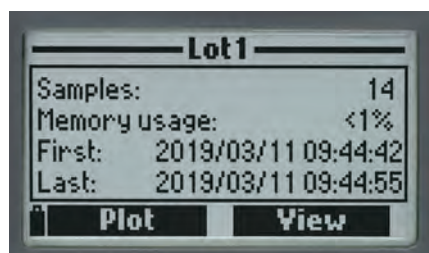

### Data Logging

The HI98199 allows users to store up to 45,000 continuous or log-on-demand samples with logging intervals from one second to three hours.

### PC Connectivity

Logged data can be transferred to a Window's compatible PC with the included micro USB cable and Hanna software.

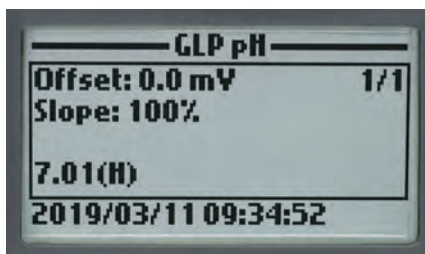

### GLP Data

HI98199 includes a GLP feature that allows users to view calibration data and calibration expiration information at the touch of a key. Calibration data includes date, time, buffers/standards used for calibration, and slope characteristics.

### Dedicated Help Key

Contextual help is always available through a dedicated "HELP" key. Clear tutorial messages and directions are available on-screen to quickly and easily guide users through setup and calibration. The help information displayed is relative to the setting/option being viewed.

### Long Battery Life

The meter displays a battery icon indicator to show the remaining power. The meter uses four 1.5V AA batteries that provide up to 360 hours of battery life.



## Versatility when you need it.

Each probe transmits readings digitally to the meter, where data points can be displayed and logged.

2



pH

portable

### pH

The HI98199 allows for the measurement of pH and temperature when used with the included HI829113 digital pH probe.

- Up to a three-point calibration with five standard buffers and one custom buffer available
- pH in mV option is useful for diagnostics
- GLP data
  - Offset, slope, date, time and buffers used
- Automatically temperature compensated readings
- pH sensor
  - Gel filled and maintenance free
  - Double junction for reduced contamination of reference cell

### Conductivity

The HI98199 allows for the measurement of conductivity, TDS (total dissolved solids), Resistivity, Salinity, seawater  $\sigma$ , and temperature when used with the optional HI763093 digital EC probe.

- Single-point calibration from six standards
- Temperature compensation
  - Automatic Temperature Compensation
  - Configurable temperature coefficient range from 0.00 to 6.00%/°C
  - Choice of reference temperatures at 20 or 25°C
  - Absolute conductivity can be displayed along with the temperature compensated value
- Auto-ranging
- Salinity readings
  - Practical Salinity Scale (PSU) based on conductivity calibration

### Dissolved Oxygen

The HI98199 allows for the measurement of dissolved oxygen, atmospheric pressure, and temperature when used with the optional HI764103 digital DO probe.

- Display units in % saturation or ppm (mg/L)
- Salinity compensation for saline waters
  - Manual entry of salinity values
  - Readings compensated for salinity effects
- Built-in barometer
  - Automatic compensation for changes in atmospheric pressure
  - User selectable units
- Temperature compensation
- Automatic polarization of probe at startup
- Ready-to-use HDPE pre-tensioned membrane caps are easy to replace



HANNA

172.3 mVpH  
4.09 pH  
24.98 °C

Log Menu

HI98199  
pH • EC • DO

Navigation buttons: Up arrow, Down arrow, ESC, HELP, Light icon, Power icon.

1	2 abc	3 def
4 ghi	5 jkl	6 mno
7 pqrs	8 tuv	9 wxyz
-	0	.

Specifications	HI98199	
pH / mV (using included HI829113 pH Probe)	Range	0.00 to 14.00 pH / $\pm 600.0$ mV
	Resolution	0.01 pH / 0.1 mV
	Accuracy	$\pm 0.02$ pH / $\pm 0.5$ mV
	Calibration	automatic one, two, or three points of five standard buffers (pH 4.01, 6.86, 7.01, 9.18, 10.01) or one custom buffer
EC (using HI763093 EC Probe)	Range	0 to 200 mS/cm
	Resolution	<b>manual:</b> 1 $\mu$ S/cm; 0.001 mS/cm; 0.01 mS/cm; 0.1 mS/cm; 1 mS/cm; <b>automatic:</b> 1 $\mu$ S/cm from 0 to 9999 $\mu$ S/cm; 0.01 mS/cm from 10.00 to 99.99 mS/cm; 0.1 mS/cm from 100.0 to 200.0 mS/cm <b>automatic mS/cm:</b> 0.001 mS/cm from 0.000 to 9.999 mS/cm; 0.01 mS/cm from 10.00 to 99.99 mS/cm; 0.1 mS/cm from 100.0 to 200.0 mS/cm
	Accuracy	$\pm 1.5\%$ of reading or $\pm 2$ $\mu$ S/cm whichever is greater
	Calibration	automatic single point, with six standard solutions (84 $\mu$ S/cm, 1413 $\mu$ S/cm, 5.00 mS/cm, 12.88 mS/cm, 80.0 mS/cm, 111.8 mS/cm) or custom point
TDS (using HI763093 EC Probe)	Range	0.0 to 200.0 ppt (g/L) (the maximum value depends on the TDS factor)
	Resolution	<b>manual:</b> 1 ppm (mg/L); 0.001 ppt (g/L); 0.01 ppt (g/L); 0.1 ppt (g/L); 1 ppt (g/L); <b>automatic:</b> 1 ppm (mg/L) from 0 to 9999 ppm (mg/L); 0.01 ppt (g/L) from 10.00 to 99.99 ppt (g/L); 0.1 ppt (g/L) from 100.0 to 200.0 ppt (g/L) <b>automatic ppt (g/L):</b> 0.001 ppt (g/L) from 0.000 to 9.999 ppt (g/L); 0.01 ppt (g/L) from 10.00 to 99.99 ppt (g/L); 0.1 ppt (g/L) from 100.0 to 200.0 ppt (g/L)
	Accuracy	$\pm 1\%$ of reading or $\pm 1$ ppm (mg/L) whichever is greater
	Calibration	based on conductivity calibration
Resistivity (using HI763093 EC Probe)	Range	0 to 999999 $\Omega \cdot \text{cm}$ ; 0 to 1000.0 $\text{k}\Omega \cdot \text{cm}$ ; 0 to 1.0000 $\text{M}\Omega \cdot \text{cm}$
	Resolution	1 $\Omega \cdot \text{cm}$ ; 0.1 $\text{k}\Omega \cdot \text{cm}$ ; 0.0001 $\text{M}\Omega \cdot \text{cm}$
	Calibration	based on conductivity calibration
Salinity (using HI763093 EC Probe)	Range	0.00 to 70.00 PSU
	Resolution	0.01 PSU
	Accuracy	$\pm 2\%$ of reading or $\pm 0.01$ PSU whichever is greater
Seawater $\sigma$ (using HI763093 EC Probe)	Range	0.0 to 50.0 $\sigma_t, \sigma_0, \sigma_{15}$
	Resolution	0.1 $\sigma_t, \sigma_0, \sigma_{15}$
	Accuracy	$\pm 1 \sigma_t, \sigma_0, \sigma_{15}$
Dissolved Oxygen (using HI764103 DO Probe)	Range	0.0 to 500.0%; 0.00 to 50.00 ppm (mg/L)
	Resolution	0.1%; 0.01 ppm (mg/L)
	Accuracy	0.0 to 300.0%: $\pm 1.5\%$ of reading or $\pm 1.0\%$ whichever is greater; 300.0 to 500.0%: $\pm 3\%$ of reading; 0.00 to 30.00 ppm (mg/L): $\pm 1.5\%$ of reading or $\pm 0.10$ ppm (mg/L), whichever is greater; 30.00 ppm (mg/L) to 50.00 ppm (mg/L): $\pm 3\%$ of reading
Atmospheric Pressure (using HI764103 DO Probe)	Range	450 to 850 mm Hg; 17.72 to 33.46 in Hg; 600.0 to 1133.2 mbar; 8.702 to 16.436 psi; 0.5921 to 1.1184 atm; 60.00 to 113.32 kPa
	Resolution	0.1 mm Hg; 0.01 in Hg; 0.1 mbar; 0.001 psi; 0.0001 atm; 0.01 kPa
	Accuracy	$\pm 3$ mm Hg within $\pm 15^\circ\text{C}$ from the temperature during calibration
Temperature	Calibration	automatic at one custom point
	Range	$-5.00$ to $55.00^\circ\text{C}$ ; $23.00$ to $131.00^\circ\text{F}$ ; 268.15 to 328.15K
	Resolution	0.01 $^\circ\text{C}$ ; 0.01 $^\circ\text{F}$ ; 0.01K
	Accuracy	$\pm 0.15^\circ\text{C}$ ; $\pm 0.27^\circ\text{F}$ ; $\pm 0.15\text{K}$
Additional Specifications	Calibration	automatic at one custom point
	Temperature Compensation	automatic from $-5$ to $55^\circ\text{C}$ (23 to 131 $^\circ\text{F}$ )
	Logging Memory	45000 records (continuous logging or log-on-demand)
	Logging Interval	one second to three hours
	PC Connectivity	via USB (with Hanna PC software)
	Environment	0 to $50^\circ\text{C}$ (32 to 122 $^\circ\text{F}$ ); RH 100% IP67
	Battery Type / Life	1.5V AA batteries (4) / approximately 400 hours of continuous use without backlight (50 hours with backlight)
Dimensions / Weight	185.0 x 93.0 x 35.2 mm (7.3 x 3.6 x 1.4") / 400 g (14.2 oz.)	
Ordering Information	<b>HI98199</b> is supplied with the HI829113 pH digital probe with 4m (13') cable, pH calibration solution sachets, PC software, micro USB cable, batteries, quality certificate, and instruction manual in a rugged carrying case.	
Probes	<b>HI829113</b> pH digital probe with 4m (13') cable	
	<b>HI763093</b> EC digital probe with 4m (13') cable	
	<b>HI764103</b> DO digital probe with 4m (13') cable	
Accessories	<b>HI710034</b> orange protective silicone rubber boot	
	<b>HI720199</b> spare carrying case for HI98199	

HI98190

# Professional Waterproof Meter

pH/ORP

- **Waterproof**
  - IP67 rated waterproof, rugged enclosure
- **CAL Check™**
  - Alerts users to problems during calibration including dirty/broken electrode, contaminated buffer, and overall probe condition
- **Automatic or manual temperature compensation**
  - pH sensors incorporate a built-in temperature sensor
- **Calibration**
  - Up to a five-point calibration with seven standard buffers and five custom buffers available
- **Approximately 200 hour battery life**
  - Powered by (4) 1.5V AA batteries
- **Clear display**
  - Dot matrix display with multifunction virtual keys
- **AutoHold**
  - Automatically holds the first stable reading on the display
- **Calibration timeout**
  - Alerts when calibration is due at a specified interval
- **Connectivity**
  - PC connectivity via opto-isolated micro-USB with HI92000 software
- **GLP**
  - GLP data provides data from previous calibration to ensure Good Laboratory Practices are met
- **Intuitive keypad**
  - Most of the available options such as GLP information, help, range, calibration, and backlight have a dedicated button
- **Supplied complete**
  - Each meter is supplied complete with sensor, calibration solution, beakers, PC software and connection cable, instruction manual, quick start guide, and batteries in a rugged, custom carrying case.



## Designed for professionals

The HI98190 is a rugged, portable pH meter with the performance and features of a benchtop meter. Exchange out the pH probe for an ORP probe to obtain mV readings in the  $\pm 2000$  mV range. This professional, waterproof meter can easily be operated with one hand and complies with IP67 standards. The HI98190 is supplied with all necessary accessories to perform a pH/temperature measurement packaged into a durable carrying case.



### Backlit Graphic LCD Display

The HI98190 features a backlit graphic LCD with on-screen help. The graphic display allows for the use of virtual keys to provide for an intuitive user interface.

### Waterproof Protection

The meter is enclosed in an IP67 rated waterproof casing and can withstand immersion in water at a depth of 1 m for up to 30 minutes. The probe features an IP68 rating for continuous immersion in water.



### Quick Connect Probe

The HI98190 features the HI12963 titanium bodied pH/temperature electrode with a quick connect DIN connector to make attaching and removing the probe simple and easy.

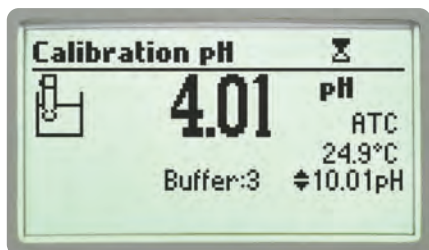

### pH Calibration

Choose from seven standard pH buffers and five custom pH buffers to obtain up to five point calibration and achieve high precision readings with a pH accuracy of  $\pm 0.002$  and up to  $\pm 0.001$  pH resolution.

### Enhanced Calibration

An "out of calibration range" warning can be engaged to keep the user informed of the current calibration and help to avoid performing measurements that are out of range.

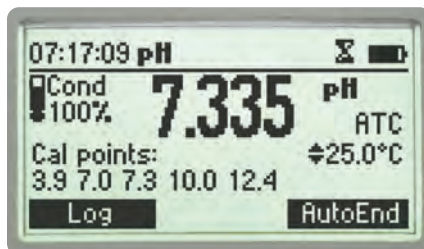

### CAL Check™

Hanna's CAL Check maintains a history of past calibrations and monitors the pH electrode and buffers during subsequent calibrations for any signs of wide variances due to a dirty or broken electrode or contaminated pH buffers. During calibration, users are alerted to problems should they occur. After calibration, the electrode's overall condition is displayed as a percentage.

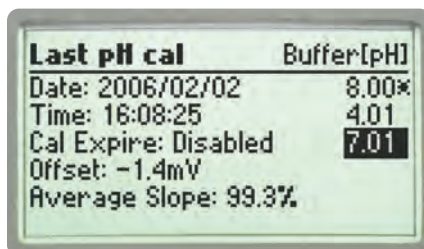

### GLP

Comprehensive GLP functions are directly accessible by pressing the GLP key. Calibration data, including date, time, and calibration values are stored for retrieval at a later time.

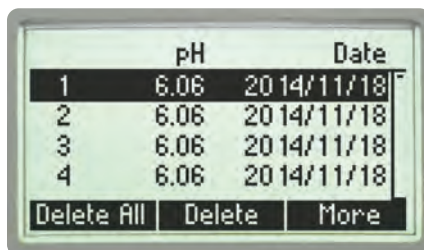

### Data Logging

The log-on-demand feature allows users to store up to 200 samples that can be later transferred to a PC with the HI920015 USB cable and HI92000 software.

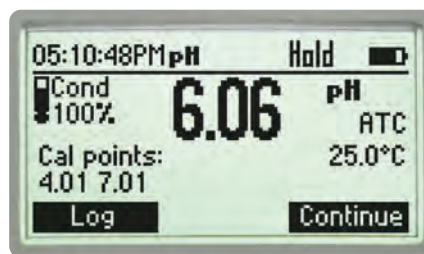

### AutoHold

Pressing AutoHold during measurement will automatically hold the first stable reading on the display.

### Intuitive Keypad

The fitted rubber keypad has dedicated keys for power, backlight, up/down arrows, help, and alphanumeric characters. The meter also features two virtual soft keys that navigate the user through the configuration of each parameter, meter setup, and logging of data. The interface is intuitive for any user's level of experience.



### Dedicated Help Key

Contextual help is always available through a dedicated "HELP" key. Clear tutorial messages and directions are available on-screen to quickly and easily guide users through setup and calibration. The help information displayed is relative to the setting/option being viewed.

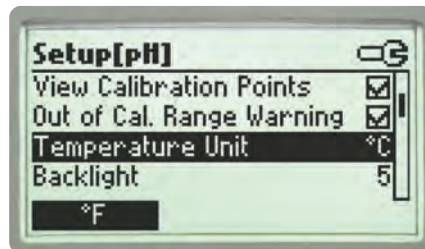

### Setup Screen

Our extensive setup screen features a host of configurable options such as time, date, temperature units, and language for help screens and guides.



### Supplied Complete in a Rugged Custom Carrying Case

The HI98190 meter, probe, and accessories are supplied in the HI720190 rugged carrying case designed to provide years of use. The inside compartment of the carrying case is thermoformed to securely hold and protect all of the components.



### HI12963 pH Electrode

- **Titanium body**
  - Titanium construction provides an unbreakable structure and allows the transfer of heat to the internal temperature sensor for rapid temperature compensation.
- **Maintenance free, gel-filled electrode**
  - No fill solution required



### PC Connectivity

Logged data can be transferred to a Windows compatible PC with the included HI920015 micro USB cable and HI92000 software.

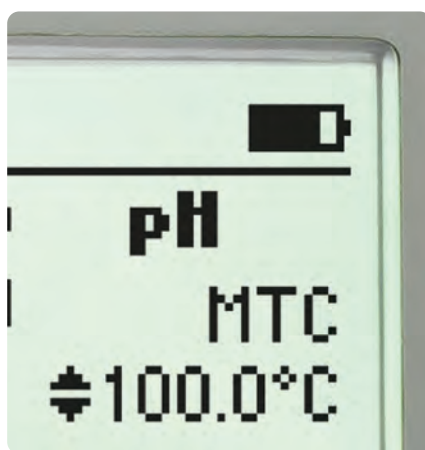

### Long Battery Life

The display of the meter has a battery icon to show the remaining power. The meter uses four 1.5V AA batteries that provide up to 200 hours of battery life.

### Calibration Error Messages

Calibration is successfully performed if the reading is within certain limits.

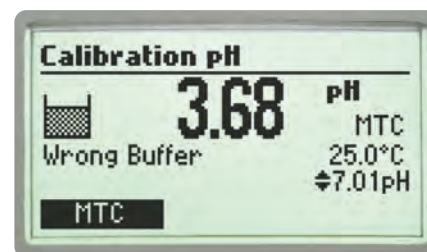

Wrong Buffer – The pH reading is not within range of the selected buffer.

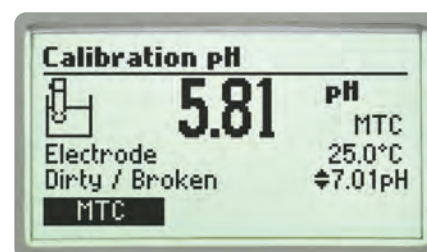

Electrode Dirty/Broken alternatively with Buffer Contaminated –The offset of the electrode is not in the accepted range. Check if the electrode is broken or clean it following the Cleaning Procedure at the end of this section. Check the quality of the buffer. If necessary, change the buffer.

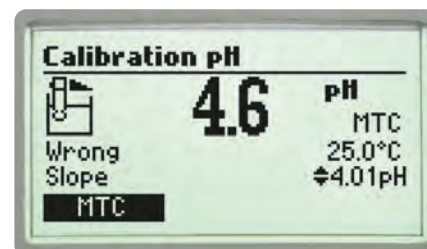

Wrong or Wrong Old Slope – An inconsistency between new and previous (old) calibration is detected.

### Calibrate right in the case with custom beaker holders

Our custom carrying case features beaker holders for calibration out in the field.



- Optional shockproof silicon rubber boot
  - Specially designed to protect your instrument from damage or impact

HI710034 Orange

## Specifications

## HI98190

pH*	Range	-2.0 to 20.0 pH; -2.00 to 20.00 pH; -2.000 to 20.000 pH
	Resolution	0.1 pH; 0.01 pH; 0.001 pH
	Accuracy	±0.1 pH; ±0.01 pH; ±0.002 pH
	Calibration	up to five-point calibration, seven standard buffers available (1.68, 4.01, 6.86, 7.01, 9.18, 10.01, 12.45) and five custom buffers
	Temperature Compensation	automatic or manual from -20.0 to 120.0°C (-4.0 to 248.0°F)
mV*	Range	±2000 mV
	Resolution	0.1 mV
	Accuracy	±0.2 mV
	Relative mV Offset Range	±2000 mV
Temperature*	Range	-20.0 to 120.0 °C (-4.0 to 248.0°F)
	Resolution	0.1°C (0.1°F)
	Accuracy	±0.4°C (±0.8°F) (excluding probe error)
Additional Specifications	pH Probe	HI12963 titanium body, pH electrode with internal temperature sensor, quick DIN connector and 1 m (3.3' cable)
	Slope Calibration	from 80 to 110%
	Log-on-demand	200 samples (100 each pH/mV range)
	PC Connection	opto-isolated USB with HI92000 software and micro USB cable
	Input Impedance	10 <sup>12</sup> Ω
	Battery Type / Life	1.5V AA batteries (4) / approximately 200 hours of continuous use without backlight (50 hours with backlight)
	Auto-off	user selectable: 5, 10, 30, 60 min, disabled
	Environment	0 to 50°C (32 to 122°F); RH 100% IP67
	Dimensions / Weight	185 x 93 x 35.2 mm (7.3 x 3.6 x 1.4") / 400 g (14.2 oz.)
Ordering Information	<p><b>HI98190</b> is supplied with HI12963 pH electrode, HI7004M pH 4.01 buffer solution (230 mL), HI7007M pH 7.01 buffer solution (230 mL), electrode cleaning solution sachet (2), 100 mL plastic beaker (2), HI92000 PC software, HI920015 micro USB cable, 1.5V AA batteries (4), quick start guide, quality certificate, and instruction manual in an HI720190 rugged carrying case with custom insert.</p> <p><b>HI98190-03</b> includes the above without electrode.</p>	
Accessories	<b>HI710034</b> orange protective rubber boot	

\* Limits will be reduced to actual sensor limits

## Foodcare

HI98161

### pH / Temperature Meter for Food

HI98161 is a professional portable pH and temperature meter with a probe designed specifically for pH measurement in the Food sector.

- **Waterproof**
  - IP67 rated waterproof, rugged enclosure
- **CAL Check™**
  - Alerts users to problems during calibration including dirty/broken electrode, contaminated buffer, and overall probe condition
- **Automatic or manual temperature compensation**
  - pH sensors incorporate a built-in temperature sensor
- **Calibration**
  - Up to a five-point calibration with seven standard buffers and five custom buffers
- **Approximately 200 hour battery life**
  - Powered by 4 1.5V AA batteries
- **Clear display**
  - Dot matrix display with multifunction virtual keys
- **Auto hold**
  - Automatically holds the first stable reading on the display
- **Calibration timeout**
  - Alerts when calibration is due at a specified interval
- **Connectivity**
  - PC connectivity via opto-isolated micro-USB with HI92000 software
- **GLP**
  - GLP data provides data from previous calibration to ensure Good Laboratory Practices are met
- **Intuitive keypad**
  - Important and often used functions such as GLP information, help, range, calibration, and backlight have a dedicated button
- **Supplied complete**
  - Each meter is supplied complete with sensor, calibration and cleaning solutions, beakers, PC software and connection cable, instruction manual, quick start guide, and batteries in a rugged, custom carrying case





# Foodcare pH Meter

designed for food professionals

Hanna foodcare pH meters are rugged and portable with the performance and features of a benchtop. Eight models are available in this series to measure food, milk, meat, yogurt, cheese, beer, wine, and soil. Each model is supplied with an application specific electrode and cleaning solutions. These waterproof meters comply to IP67 standards and can be easily operated with one hand.



## Backlit Graphic LCD Display

These meters feature a backlit graphic LCD with on-screen help. The graphic display allows for the use of virtual keys to provide for an intuitive user interface.

## Waterproof Protection

The meter is enclosed in an IP67 rated waterproof casing and can withstand immersion in water at a depth of 1 m for up to 30 minutes.



## Quick Connect Probe

Each meter features an application specific pH/temperature probe with a quick connect DIN connector to make attaching and removing the probe simple and easy.

## Calibration Timeout

Alerts when calibration is due at a specified interval.

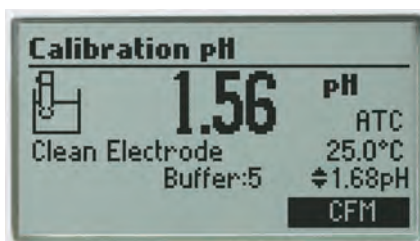

## pH Calibration

Choose from seven standard pH buffers and five custom values to obtain up to five point calibration and achieve high precision readings with a 0.001 pH resolution and a pH accuracy of  $\pm 0.002$ .

## Enhanced Calibration

An "out of calibration range" warning can be engaged to keep the user informed of the current calibration and help to avoid performing measurements that are out of the bracketed range.



## CAL Check™

Hanna's CAL Check maintains a history of past calibrations and monitors the pH electrode and buffers during subsequent calibrations for any signs of wide variances due to a dirty or broken electrode or contaminated pH buffers. During calibration, users are alerted to problems should they occur. After calibration, the electrode's overall condition is displayed as a percentage.



## GLP

Comprehensive GLP functions are directly accessible by pressing the GLP key. Calibration data including date, time and calibration values are stored with logged data for retrieval at a later time.



## Data Logging

The log-on-demand feature allows users to store up to 200 samples that can later be transferred to a PC with the HI920015 USB cable and HI92000 software.

## Automatic Temperature Compensation

pH sensors incorporate a built-in temperature sensor in the tip of the electrode for a fast and accurate temperature compensated value.

## Intuitive Keypad

The fitted rubber keypad has dedicated keys for many important and often used functions. These meters also feature two virtual soft keys that navigate the user through setup and logging of data. The interface is intuitive for any user's level of experience.

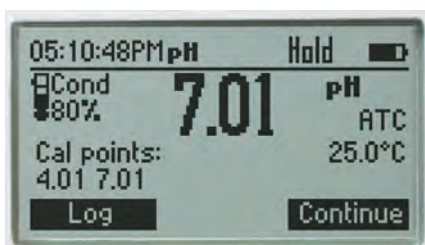

### Auto Hold

Pressing AutoEnd during measurement will automatically hold the first stable reading on the display.



### Dedicated Help Key

Contextual help is always available through a dedicated "HELP" key. Clear tutorial messages and directions are available on-screen to quickly and easily guide users through setup and calibration. The help information displayed is relative to the setting/option being viewed.



### Setup Screen

Our extensive setup screen features a host of configurable options such as time, date, temperature units, and language for help screens and guides.



### PC Connectivity

Logged data can be transferred to a Windows compatible PC with the included HI920015 micro USB cable and HI92000 software.

### Long Battery Life

The display of the meter has a battery icon indicator to show the remaining power. The meter uses four 1.5V AA batteries that provide up to 200 hours of battery life.



### Supplied Complete in a Rugged Custom Carrying Case

Each meter is supplied complete with sensor, calibration and cleaning solutions, beakers, PC software and connection cable, instruction manual, quick start guide, and batteries in a rugged, custom carrying case. The inside compartment of the carrying case is thermoformed to securely hold and protect all of the components.

Specifications	HI98161	
pH*	Range	-2.0 to 20.0 pH; -2.00 to 20.00 pH; -2.000 to 20.000 pH
	Resolution	0.1 pH; 0.01 pH; 0.001 pH
	Accuracy	±0.1 pH; ±0.01 pH; ±0.002 pH
	Calibration	up to five-point calibration, seven standard buffers available (1.68, 4.01, 6.86, 7.01, 9.18, 10.01, 12.45) and five custom buffers
	Temperature Compensation	automatic or manual from -20.0 to 120.0°C (-4.0 to 248.0°F)
mV	Range	±2000 mV
	Resolution	0.1 mV
	Accuracy	±0.2 mV
	Relative mV Offset Range	±2000 mV
Temperature*	Range	-20.0 to 120.0 °C (-4.0 to 248.0°F)
	Resolution	0.1°C (0.1°F)
	Accuracy	±0.4°C (±0.8°F) (excluding probe error)
Additional Specifications	pH Probe	FC2023 PVDF body, pH electrode with internal temperature sensor, quick DIN connector and 1 m (3.3' cable)
	Slope Calibration	from 80 to 110%
	Log-on-demand	Up to 200 samples (100 pH, 100 mV)
	PC Connection	opto-isolated USB with HI92000 software and micro USB cable
	Input Impedance	10 <sup>12</sup> Ω
	Battery Type / Life	1.5V AA batteries (4) / approximately 200 hours of continuous use without backlight (50 hours with backlight)
	Auto-off	user selectable: 5, 10, 30, 60 min, disabled
	Environment	0 to 50°C (32 to 122°F); RH 100% IP67
	Dimensions / Weight	185 x 93 x 35.2 mm (7.3 x 3.6 x 1.4") / 400 g (14.2 oz.)
	Ordering Information	<b>HI98161</b> is supplied with FC2023 pH electrode, HI7004M pH 4.01 buffer solution (230 mL), HI7007M pH 7.01 buffer solution (230 mL), HI700641 electrode cleaning solution sachet for dairy deposits (2), 100 mL plastic beaker (2), HI92000 PC software, HI920015 micro USB cable, 1.5V AA batteries (4), quality certificate, and instruction manual in a hard carrying case with custom insert.
Accessories	<b>HI710035</b> blue protective rubber boot	

\* Limits will be reduced to actual probe/sensor limits.



- **Optional shockproof silicon rubber boot**
- Specially designed to protect your instrument from damage or impact

**HI710035** Blue

## pH / Temperature Probe for Food

When measuring pH, food products can pose a number of challenges. Samples can vary in consistency from solid, semi-solid, to a slurry with a high content of solids. These sample types can coat the sensitive glass membrane surface and/or clog the reference junction. Designed specifically for measuring pH in food, the FC2023 has a conic tip shape for easy penetration, an open junction to resist clogging, and a PVDF food grade plastic body that can be cleaned with sodium hypochlorite. The FC2023 is an ideal general purpose pH electrode for use in food manufacturing.

### PVDF body

Polyvinylidene fluoride (PVDF) is a food grade plastic that is resistant to most chemicals and solvents, including sodium hypochlorite. It has high abrasion resistance, mechanical strength, and resistance to ultraviolet and nuclear radiation. PVDF is also resistant to fungal growth.

### Low temperature glass

The FC2023 electrode uses Low Temperature (LT) glass for the sensing bulb. The LT glass tip is a lower resistance glass formulation. As the temperature of the sensing glass decreases, the resistance of the LT glass will increase approaching that of standard glass at ambient temperatures. The FC2023 is suitable to use with samples that measure from 0 to 50°C.

### Open junction reference

Clogging of the reference junction is a common challenge faced by food producers that measure pH in slurries and semi-solid products. The solids can easily clog the ceramic junction used with standard laboratory pH electrodes. The open junction design of the FC2023 resists clogging and continues to provide accurate, stable readings.

### Viscolene electrolyte

The viscolene electrolyte offers a hard gel interface between the inner electrode components and the sample being measured. The electrolyte is silver-free for use in food products and is maintenance-free.

### Conic tip shape

This design allows for penetration into semisolids and emulsions for the direct measurement of pH in a variety of food products including sauces, dough, and other semi-solids.

### Built-in temperature sensor

A thermistor temperature sensor is in the tip of the indicating pH electrode. A temperature sensor should be as close as possible to the indicating pH bulb in order to compensate for variations in temperature.



## Application Importance

One of the most common measurements of food products is pH because of how it affects food characteristics such as shelf stability, texture, and flavor. Foods are generally broken into two groups based on their pH value. These groups include acid foods which have a naturally low pH of 4.6 or below and low-acid foods that have a finished equilibrium pH value greater than pH 4.6 and a water activity greater than 0.85. The low-acid foods can be pH adjusted with the addition of an acid to lower the final pH and become an acidified food.

In food processing, some products require the measurement of pH to meet industry regulations to ensure the quality and safety of goods. A lower pH will help in preventing unwanted bacteria from growing thus extending the shelf life of a product. While food safety is a crucial consideration, understanding the pH of a food product can also help to achieve consistent flavors and textures. Through fermentation and other biological processes, many foodstuffs only achieve their desired qualities at particular pH values or ranges. pH is an essential parameter that requires close observation throughout food production to provide the best possible product.

Specifications	FC2023
Description	pre-amplified pH/temperature probe
Reference	single, Ag/AgCl
Junction	open
Electrolyte	viscolene
Max Pressure	0.1 bar
Range	pH: 0 to 12
Recommended Operating Temperature	0 to 50°C (32 to 122°F)
Glass Type	LT (low temperature)
Tip /Shape	conic (dia: 6 x 10 mm)
Temperature Sensor	yes
Amplifier	yes
Body Material	PVDF
Cable	coaxial; 1 m (3.3')
Connection	quick connect DIN

## Foodcare

HI98162

### pH / Temperature Meter for Milk

HI98162 is a professional portable pH and temperature meter with a probe designed specifically for pH measurement in milk.

- **Waterproof**
  - IP67 rated waterproof, rugged enclosure
- **CAL Check™**
  - Alerts users to problems during calibration including dirty/broken electrode, contaminated buffer, and overall probe condition
- **Automatic or manual temperature compensation**
  - pH sensors incorporate a built-in temperature sensor
- **Calibration**
  - Up to a five-point calibration with seven standard buffers and five custom buffers
- **Approximately 200 hour battery life**
  - Powered by four 1.5V AA batteries
- **Clear display**
  - Dot matrix display with multifunction virtual keys
- **Auto hold**
  - Automatically holds the first stable reading on the display
- **Calibration timeout**
  - Alerts when calibration is due at a specified interval
- **Connectivity**
  - PC connectivity via opto-isolated micro-USB with HI92000 software
- **GLP**
  - GLP data provides data from previous calibration to ensure Good Laboratory Practices are met
- **Intuitive keypad**
  - Important and often used functions such as GLP information, help, range, calibration, and backlight have a dedicated button
- **Supplied complete**
  - Each meter is supplied complete with sensor, calibration and cleaning solutions, beakers, PC software and connection cable, instruction manual, quick start guide, and batteries in a rugged, custom carrying case



# Milk pH Meter

designed for food professionals

Hanna foodcare pH meters are rugged and portable with the performance and features of a benchtop. Eight models are available in this series to measure food, milk, meat, yogurt, cheese, beer, wine, and soil. Each model is supplied with an application specific electrode and cleaning solutions. These waterproof meters comply to IP67 standards and can be easily operated with one hand.



## Backlit Graphic LCD Display

These meters feature a backlit graphic LCD with on-screen help. The graphic display allows for the use of virtual keys to provide for an intuitive user interface.

## Waterproof Protection

The meter is enclosed in an IP67 rated waterproof casing and can withstand immersion in water at a depth of 1 m for up to 30 minutes.



## Quick Connect Probe

Each meter features an application specific pH/temperature probe with a quick connect DIN connector to make attaching and removing the probe simple and easy.

## Calibration Timeout

Alerts when calibration is due at a specified interval.

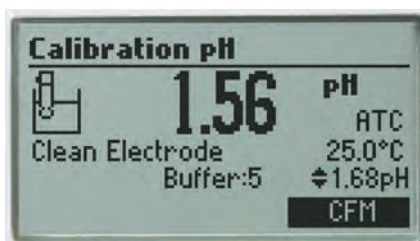

## pH Calibration

Choose from seven standard pH buffers and five custom values to obtain up to five point calibration and achieve high precision readings with a 0.001 pH resolution and a pH accuracy of  $\pm 0.002$ .

## Enhanced Calibration

An "out of calibration range" warning can be engaged to keep the user informed of the current calibration and help to avoid performing measurements that are out of the bracketed range.

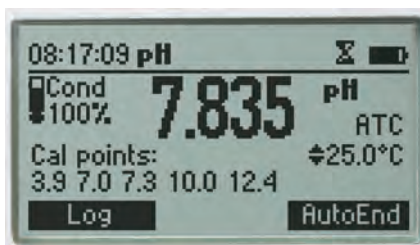

## CAL Check™

Hanna's CAL Check maintains a history of past calibrations and monitors the pH electrode and buffers during subsequent calibrations for any signs of wide variances due to a dirty or broken electrode or contaminated pH buffers. During calibration, users are alerted to problems should they occur. After calibration, the electrode's overall condition is displayed as a percentage.



## GLP

Comprehensive GLP functions are directly accessible by pressing the GLP key. Calibration data including date, time, and calibration values are stored with logged data for retrieval at a later time.



## Data Logging

The log-on-demand feature allows users to store up to 200 samples that can later be transferred to a PC with the HI920015 USB cable and HI92000 software.

## Automatic Temperature Compensation

pH sensors incorporate a built-in temperature sensor in the tip of the electrode for a fast and accurate temperature compensated value.

## Intuitive Keypad

The fitted rubber keypad has dedicated keys for many important and often used functions. These meters also feature two virtual soft keys that navigate the user through setup and logging of data. The interface is intuitive for any user's level of experience.

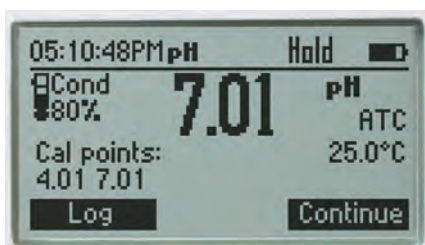

### Auto Hold

Pressing AutoEnd during measurement will automatically hold the first stable reading on the display.



### Dedicated Help Key

Contextual help is always available through a dedicated "HELP" key. Clear tutorial messages and directions are available on-screen to quickly and easily guide users through setup and calibration. The help information displayed is relative to the setting/option being viewed.



### Setup Screen

Our extensive setup screen features a host of configurable options such as time, date, temperature units, and language for help screens and guides.



### PC Connectivity

Logged data can be transferred to a Windows compatible PC with the included HI920015 micro USB cable and HI92000 software.

### Long Battery Life

The display of the meter has a battery icon indicator to show the remaining power. The meter uses four 1.5V AA batteries that provide up to 200 hours of battery life.



### Supplied Complete in a Rugged Custom Carrying Case

Each meter is supplied complete with sensor, calibration and cleaning solutions, beakers, PC software and connection cable, instruction manual, quick start guide, and batteries in a rugged, custom carrying case. The inside compartment of the carrying case is thermoformed to securely hold and protect all of the components.

Specifications	HI98162	
pH*	Range	-2.0 to 20.0 pH; -2.00 to 20.00 pH; -2.000 to 20.000 pH
	Resolution	0.1 pH; 0.01 pH; 0.001 pH
	Accuracy	±0.1 pH; ±0.01 pH; ±0.002 pH
	Calibration	up to five-point calibration, seven standard buffers available (1.68, 4.01, 6.86, 7.01, 9.18, 10.01, 12.45) and five custom buffers
	Temperature Compensation	automatic or manual from -20.0 to 120.0°C (-4.0 to 248.0°F)
mV	Range	±2000 mV
	Resolution	0.1 mV
	Accuracy	±0.2 mV
	Relative mV Offset Range	±2000 mV
Temperature*	Range	-20.0 to 120.0 °C (-4.0 to 248.0°F)
	Resolution	0.1°C (0.1°F)
	Accuracy	±0.4°C (±0.8°F) (excluding probe error)
Additional Specifications	pH Probe	FC1013 PVDF body, pH electrode with internal temperature sensor, quick DIN connector and 1 m (3.3' cable)
	Slope Calibration	from 80 to 110%
	Log-on-demand	Up to 200 samples (100 pH, 100 mV)
	PC Connection	opto-isolated USB with HI92000 software and micro USB cable
	Input Impedance	10 <sup>12</sup> Ω
	Battery Type / Life	1.5V AA batteries (4) / approximately 200 hours of continuous use without backlight (50 hours with backlight)
	Auto-off	user selectable: 5, 10, 30, 60 min, disabled
	Environment	0 to 50°C (32 to 122°F); RH 100% IP67
	Dimensions / Weight	185 x 93 x 35.2 mm (7.3 x 3.6 x 1.4") / 400 g (14.2 oz.)
	Ordering Information	HI98162 is supplied with FC1013 pH electrode, HI7004M pH 4.01 buffer solution (230 mL), HI7007M pH 7.01 buffer solution (230 mL), HI700640 electrode cleaning solution sachet for milk deposits (2), 100 mL plastic beaker (2), HI92000 PC software, HI920015 micro USB cable, 1.5V AA batteries (4), quality certificate, and instruction manual in a hard carrying case with custom insert.
Accessories	HI710035 blue protective rubber boot	



- Optional shockproof silicon rubber boot
- Specially designed to protect your instrument from damage or impact

HI710035 Blue

\* Limits will be reduced to actual probe/sensor limits.

## pH / Temperature Probe for Milk

The FC1013 pH electrode has a built-in temperature sensor for simultaneous temperature compensated pH and temperature readings, and also contains a pH sensor preamplifier to provide measurements impervious to noise and electrical interferences.

FC1013 electrode is designed to prevent the typical problems of clogging in viscous and proteinaceous liquids ensuring a fast response and stable reading.

### PVDF body

The FC1013 is composed of food grade PVDF plastic. This material is highly durable and chemically resistant.

### General purpose glass

The FC1013 uses general purpose (GP) glass. The formulation allows for fast response over a wide range of temperatures. The FC1013 is suitable to use with samples that measure from 0 to 80°C.

### Refillable electrolyte

The silver-free electrolyte ensures no silver precipitate can clog the junction. An easy to use fill cap allows for quick refilling of electrolyte solution to maintain adequate head pressure.

### Single ceramic junction

A porous ceramic frit allows the silver-free electrolyte to flow slowly into solution, providing accurate readings for aqueous samples.

### Spheric tip shape

The shape of the sensing membrane provides a large surface area for contact with milk samples. The highly durable construction provides accurate measurements on the dairy farm as well as the production facility.

### Built-in temperature sensor

A thermistor temperature sensor is in the tip of the indicating pH bulb. A temperature sensor should be as close as possible to the indicating pH electrode in order to compensate for variations in temperature.



Specifications	FC1013
Description	pre-amplified pH/temperature probe
Reference	double, Ag/AgCl
Junction	ceramic, single
Electrolyte	KCl 3.5M
Max Pressure	0.1 bar
Range	pH: 0 to 13
Recommended Operating Temperature	0 to 80°C (32 to 176°F)
Glass Type	GP (general purpose)
Tip /Shape	spheric (dia: 7.5 mm)
Temperature Sensor	yes
Amplifier	yes
Body Material	PVDF
Cable	coaxial; 1 m (3.3')
Connection	quick connect DIN

## Application Importance

The measurement of pH in milk is important in testing for impurities, spoilage, and signs of mastitis infection. While there are a number of factors that affect the composition of milk, pH measurements can help producers understand what might be causing certain compositional changes. pH measurements are commonly performed at various points in a milk processing plant.

Fresh milk has a pH value of 6.7. When the pH value of the milk falls below pH 6.7, it typically indicates spoilage by bacterial degradation. Bacteria from the family of Lactobacillaceae are lactic acid bacteria (LAB) responsible for the breakdown of the lactose in milk to form lactic acid. Eventually when the milk reaches an acidic enough pH, coagulation or curdling will occur along with the characteristic smell and taste of "sour" milk.

Milk with pH values higher than pH 6.7 potentially indicate that the milk may have come from cows infected with mastitis. Mastitis is an ever-present challenge with dairy milking cows. When infected, the cow's immune system releases histamine and other compounds in response to the infection. There is a resulting increase in permeability of endothelial and epithelial cell layers, allowing blood components to pass through a paracellular pathway. Since blood plasma is slightly alkaline, the resulting pH of milk will be higher than normal. Typically milk producers can perform a somatic cell count to detect a mastitis infection, but a pH measurement offers a quick way to screen for infection.

Understanding the pH of raw milk can also help producers optimize their processing techniques. For example, in operations that use Ultra High Temperature (UHT) processing, even small variations from pH 6.7 can affect the time required for pasteurization and the stability of the milk after treatment.

## Foodcare

HI98163

### pH / Temperature Meter for Meat

HI98163 is a professional portable pH and temperature meter with a probe designed specifically for pH measurement in meat.

- **Waterproof**
  - IP67 rated waterproof, rugged enclosure
- **CAL Check™**
  - Alerts users to problems during calibration including dirty/broken electrode, contaminated buffer, and overall probe condition
- **Automatic or manual temperature compensation**
  - pH sensors incorporate a built-in temperature sensor
- **Calibration**
  - Up to a five-point calibration with seven standard buffers and five custom buffers
- **Approximately 200 hour battery life**
  - Powered by four 1.5V AA batteries
- **Clear display**
  - Dot matrix display with multifunction virtual keys
- **Auto hold**
  - Automatically holds the first stable reading on the display
- **Calibration timeout**
  - Alerts when calibration is due at a specified interval
- **Connectivity**
  - PC connectivity via opto-isolated micro-USB with HI92000 software
- **GLP**
  - GLP data provides data from previous calibration to ensure Good Laboratory Practices are met
- **Intuitive keypad**
  - Important and often used functions such as GLP information, help, range, calibration, and backlight have a dedicated button
- **Supplied complete**
  - Each meter is supplied complete with sensor, calibration and cleaning solutions, beakers, PC software and connection cable, instruction manual, quick start guide, and batteries in a rugged, custom carrying case





# Meat pH Meter

designed for food professionals

Hanna foodcare pH meters are rugged and portable with the performance and features of a benchtop. Eight models are available in this series to measure food, milk, meat, yogurt, cheese, beer, wine, and soil. Each model is supplied with an application specific electrode and cleaning solutions. These waterproof meters comply to IP67 standards and can be easily operated with one hand.



## Backlit Graphic LCD Display

These meters feature a backlit graphic LCD with on-screen help. The graphic display allows for the use of virtual keys to provide for an intuitive user interface.

## Waterproof Protection

The meter is enclosed in an IP67 rated waterproof casing and can withstand immersion in water at a depth of 1 m for up to 30 minutes.



## Quick Connect Probe

Each meter features an application specific pH/temperature probe with a quick connect DIN connector to make attaching and removing the probe simple and easy.

## Calibration Timeout

Alerts when calibration is due at a specified interval.

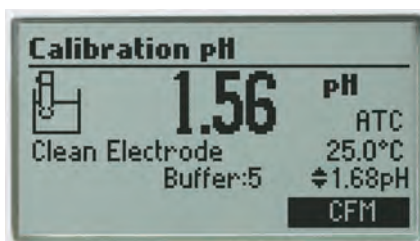

## pH Calibration

Choose from seven standard pH buffers and five custom values to obtain up to five point calibration and achieve high precision readings with a 0.001 pH resolution and a pH accuracy of  $\pm 0.002$ .

## Enhanced Calibration

An "out of calibration range" warning can be engaged to keep the user informed of the current calibration and help to avoid performing measurements that are out of the bracketed range.



## CAL Check™

Hanna's CAL Check maintains a history of past calibrations and monitors the pH electrode and buffers during subsequent calibrations for any signs of wide variances due to a dirty or broken electrode or contaminated pH buffers. During calibration, users are alerted to problems should they occur. After calibration, the electrode's overall condition is displayed as a percentage.



## GLP

Comprehensive GLP functions are directly accessible by pressing the GLP key. Calibration data including date, time, and calibration values are stored with logged data for retrieval at a later time.



## Data Logging

The log-on-demand feature allows users to store up to 200 samples that can later be transferred to a PC with the HI920015 USB cable and HI92000 software.

## Automatic Temperature Compensation

pH sensors incorporate a built-in temperature sensor in the tip of the electrode for a fast and accurate temperature compensated value.

## Intuitive Keypad

The fitted rubber keypad has dedicated keys for many important and often used functions. These meters also feature two virtual soft keys that navigate the user through setup and logging of data. The interface is intuitive for any user's level of experience.

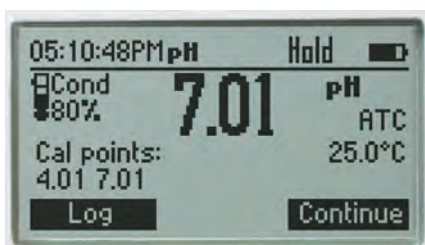

### Auto Hold

Pressing AutoEnd during measurement will automatically hold the first stable reading on the display.



### Dedicated Help Key

Contextual help is always available through a dedicated "HELP" key. Clear tutorial messages and directions are available on-screen to quickly and easily guide users through setup and calibration. The help information displayed is relative to the setting/option being viewed.



### Setup Screen

Our extensive setup screen features a host of configurable options such as time, date, temperature unit, and language for help screens and guides.



### PC Connectivity

Logged data can be transferred to a Windows compatible PC with the included HI920015 micro USB cable and HI92000 software.

## Long Battery Life

The display of the meter has a battery icon indicator to show the remaining power. The meter uses four 1.5V AA batteries that provide up to 200 hours of battery life.



## Supplied Complete in a Rugged Custom Carrying Case

Each meter is supplied complete with sensor, calibration and cleaning solutions, beakers, PC software and connection cable, instruction manual, quick start guide, and batteries in a rugged, custom carrying case. The inside compartment of the carrying case is thermoformed to securely hold and protect all of the components.

Specifications		HI98163
pH*	Range	-2.0 to 20.0 pH; -2.00 to 20.00 pH; -2.000 to 20.000 pH
	Resolution	0.1 pH; 0.01 pH; 0.001 pH
	Accuracy	±0.1 pH; ±0.01 pH; ±0.002 pH
	Calibration	up to five-point calibration, seven standard buffers available (1.68, 4.01, 6.86, 7.01, 9.18, 10.01, 12.45) and five custom buffers
	Temperature Compensation	automatic or manual from -20.0 to 120.0°C (-4.0 to 248.0°F)
mV	Range	±2000 mV
	Resolution	0.1 mV
	Accuracy	±0.2 mV
	Relative mV Offset Range	±2000 mV
Temperature*	Range	-20.0 to 120.0°C (-4.0 to 248.0°F)
	Resolution	0.1°C (0.1°F)
	Accuracy	±0.4°C (±0.8°F) (excluding probe error)
Additional Specifications	pH Probe	FC2323 PVDF body, pH electrode with internal temperature sensor, quick DIN connector and 1 m (3.3' cable)
	Slope Calibration	from 80 to 110%
	Log-on-demand	Up to 200 samples (100 pH, 100 mV)
	PC Connection	opto-isolated USB with HI92000 software and micro USB cable
	Input Impedance	10 <sup>12</sup> Ω
	Battery Type / Life	1.5V AA batteries (4) / approximately 200 hours of continuous use without backlight (50 hours with backlight)
	Auto-off	user selectable: 5, 10, 30, 60 min, disabled
	Environment	0 to 50°C (32 to 122°F); RH 100% IP67
	Dimensions / Weight	185 x 93 x 35.2 mm (7.3 x 3.6 x 1.4") / 400 g (14.2 oz.)
	Ordering Information	HI98163 is supplied with FC2323 pH electrode, FC099 meat piercing stainless steel blade, HI7004M pH 4.01 buffer solution (230 mL), HI7007M pH 7.01 buffer solution (230 mL), HI700630 electrode acid cleaning solution sachet for meat grease and fat deposits (2), 100 mL plastic beaker (2), HI92000 PC software, HI920015 micro USB cable, 1.5V AA batteries (4), quality certificate, and instruction manual in a hard carrying case with custom insert.
Accessories	HI710035 blue protective rubber boot	



- Optional shockproof silicon rubber boot
- Specially designed to protect your instrument from damage or impact

HI710035 Blue

\* Limits will be reduced to actual probe/sensor limits.

## pH / Temperature Probe for Meat

The FC2323 probe has been specially designed with a stainless steel blade tip for meat penetration.

### PVDF body

Polyvinylidene fluoride (PVDF) is a food grade plastic that is resistant to most chemicals and solvents, including sodium hypochlorite. It has high abrasion resistance, mechanical strength, and resistance to ultraviolet and nuclear radiation. PVDF is also resistant to fungal growth.

### Viscolene electrolyte

The viscolene electrolyte offers a hard gel interface between the inner electrode components and the sample being measured. The electrolyte is silver-free for use in food products and is maintenance-free.

### Stainless steel piercing blade

The FC099 (35mm; 1.38") stainless steel blade can be attached to the probe for easy meat penetration. Piercing into the meat will allow for the pH glass and reference junction to be in contact with the sample for a direct pH measurement without extensive sample preparation.

### Open junction reference

Clogging of the reference junction is a common challenge faced by food producers that measure pH in semi-solid products such as meat. The solids can easily clog the ceramic junction used with standard laboratory pH electrodes. The open junction design of the FC2323 resists clogging and continues to provide accurate, stable readings.

### Low temperature glass

The FC2323 electrode uses Low Temperature (LT) glass for the sensing bulb. The LT glass tip is a lower resistance glass formulation. As the temperature of the sensing glass decreases, the resistance of the LT glass will increase approaching that of standard glass at ambient temperatures. The FC2023 is suitable to use with samples that measure from 0 to 50°C.

### Built-in temperature sensor

A thermistor temperature sensor is in the tip of the indicating pH electrode. A temperature sensor should be as close as possible to the indicating pH bulb in order to compensate for variations in temperature.

### Conic tip shape

This design along with a piercing blade allows for the easy penetration into semisolids for the direct measurement of pH.



## Application Importance

In the meat production industry, the monitoring of pH is considered to be of the utmost importance due to its effect on the meat's quality factors including water binding capacity and shelf life. Upon slaughter, biochemical processes begin to break down the meat. Glycolysis begins post-mortem, converting glycogen to lactic acid, reducing the pH of the carcass. Depending on a number of factors such as type of animal and even breed, this decrease in pH can take anywhere from a single hour to many. It is vital to monitor pH during this phase as once the lowest pH value is reached, the pH will begin to slowly rise, indicating that decomposition has begun.

The pH value of meat influences its' water binding capacity which directly impacts consumer qualities such as tenderness and color. Lower pH values result in a lower water-binding capacity and lighter colors. Factors such as these can be important when considering how to efficiently produce meat products. For example, when producing dry sausages the meat must have a low water binding capacity so that it can dry evenly.

Depending on the type of the final product and the steps required to get there, pH values will vary throughout the meat processing industry. It is imperative, regardless of the final product, that pH be maintained at a low value to prevent bacterial spoilage and comply with food safety regulations. By monitoring pH values throughout the meat production process, you can ensure the creation of consistent and safe meat products.

Specifications	FC2323
Description	pre-amplified pH/temperature probe
Reference	single, Ag/AgCl
Junction	open
Electrolyte	viscolene
Max Pressure	0.1 bar
Range	pH: 0 to 12
Recommended Operating Temperature	0 to 50°C (32 to 122°F)
Glass Type	LT (low temperature)
Tip /Shape	conic (dia: 6 x 10 mm)
Temperature Sensor	yes
Amplifier	yes
Body Material	PVDF
Cable	coaxial; 1 m (3.3')
Connection	quick connect DIN

HI98164

## pH / Temperature Meter for Yogurt

HI98164 is a professional portable pH and temperature meter with a probe designed specifically for pH measurement in yogurt.

- **Waterproof**
  - IP67 rated waterproof, rugged enclosure
- **CAL Check™**
  - Alerts users to problems during calibration including dirty/broken electrode, contaminated buffer, and overall probe condition
- **Automatic or manual temperature compensation**
  - pH sensors incorporate a built-in temperature sensor
- **Calibration**
  - Up to a five-point calibration with seven standard buffers and five custom buffers
- **Approximately 200 hour battery life**
  - Powered by four 1.5V AA batteries
- **Clear display**
  - Dot matrix display with multifunction virtual keys
- **Auto hold**
  - Automatically holds the first stable reading on the display
- **Calibration timeout**
  - Alerts when calibration is due at a specified interval
- **Connectivity**
  - PC connectivity via opto-isolated micro-USB with HI92000 software
- **GLP**
  - GLP data provides data from previous calibration to ensure Good Laboratory Practices are met
- **Intuitive keypad**
  - Important and often used functions such as GLP information, help, range, calibration, and backlight have a dedicated button
- **Supplied complete**
  - Each meter is supplied complete with sensor, calibration and cleaning solutions, beakers, PC software and connection cable, instruction manual, quick start guide, and batteries in a rugged, custom carrying case



# Yogurt pH Meter

designed for food professionals

Hanna foodcare pH meters are rugged and portable with the performance and features of a benchtop. Eight models are available in this series to measure food, milk, meat, yogurt, cheese, beer, wine, and soil. Each model is supplied with an application specific electrode and cleaning solutions. These waterproof meters comply to IP67 standards and can be easily operated with one hand.



## Backlit Graphic LCD Display

These meters feature a backlit graphic LCD with on-screen help. The graphic display allows for the use of virtual keys to provide for an intuitive user interface.

## Waterproof Protection

The meter is enclosed in an IP67 rated waterproof casing and can withstand immersion in water at a depth of 1 m for up to 30 minutes.



## Quick Connect Probe

Each meter features an application specific pH/temperature probe with a quick connect DIN connector to make attaching and removing the probe simple and easy.

## Calibration Timeout

Alerts when calibration is due at a specified interval.

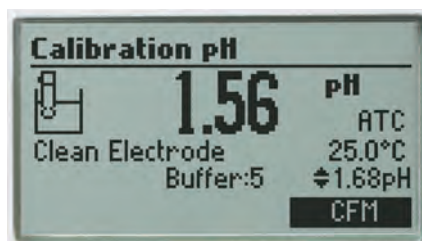

## pH Calibration

Choose from seven standard pH buffers and five custom values to obtain up to five point calibration and achieve high precision readings with a 0.001 pH resolution and a pH accuracy of  $\pm 0.002$ .

## Enhanced Calibration

An "out of calibration range" warning can be engaged to keep the user informed of the current calibration and help to avoid performing measurements that are out of the bracketed range.



## CAL Check™

Hanna's CAL Check maintains a history of past calibrations and monitors the pH electrode and buffers during subsequent calibrations for any signs of wide variances due to a dirty or broken electrode or contaminated pH buffers. During calibration, users are alerted to problems should they occur. After calibration, the electrode's overall condition is displayed as a percentage.



## GLP

Comprehensive GLP functions are directly accessible by pressing the GLP key. Calibration data, including date, time, and calibration values are stored with logged data for retrieval at a later time.



## Data Logging

The log-on-demand feature allows users to store up to 200 samples that can later be transferred to a PC with the HI920015 USB cable and HI92000 software.

## Automatic Temperature Compensation

pH sensors incorporate a built-in temperature sensor in the tip of the electrode for a fast and accurate temperature compensated value.

## Intuitive Keypad

The fitted rubber keypad has dedicated keys for many important and often used functions. These meters also feature two virtual soft keys that navigate the user through setup and logging of data. The interface is intuitive for any user's level of experience.

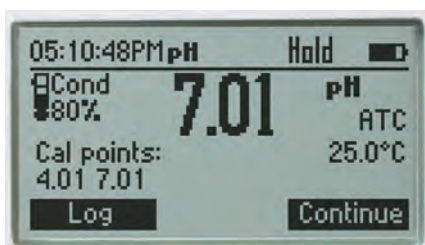

### Auto Hold

Pressing AutoEnd during measurement will automatically hold the first stable reading on the display.



### Dedicated Help Key

Contextual help is always available through a dedicated "HELP" key. Clear tutorial messages and directions are available on-screen to quickly and easily guide users through setup and calibration. The help information displayed is relative to the setting/option being viewed.



### Setup Screen

Our extensive setup screen features a host of configurable options such as time, date, temperature units, and language for help screens and guides.



### PC Connectivity

Logged data can be transferred to a Windows compatible PC with the included HI920015 micro USB cable and HI92000 software.

### Long Battery Life

The display of the meter has a battery icon indicator to show the remaining power. The meter uses four 1.5V AA batteries that provide up to 200 hours of battery life.



### Supplied Complete in a Rugged Custom Carrying Case

Each meter is supplied complete with sensor, calibration and cleaning solutions, beakers, PC software and connection cable, instruction manual, quick start guide, and batteries in a rugged, custom carrying case. The inside compartment of the carrying case is thermoformed to securely hold and protect all of the components.

Specifications	HI98164	
pH*	Range	-2.0 to 20.0 pH; -2.00 to 20.00 pH; -2.000 to 20.000 pH
	Resolution	0.1 pH; 0.01 pH; 0.001 pH
	Accuracy	±0.1 pH; ±0.01 pH; ±0.002 pH
	Calibration	up to five-point calibration, seven standard buffers available (1.68, 4.01, 6.86, 7.01, 9.18, 10.01, 12.45) and five custom buffers
	Temperature Compensation	automatic or manual from -20.0 to 120.0°C (-4.0 to 248.0°F)
mV	Range	±2000 mV
	Resolution	0.1 mV
	Accuracy	±0.2 mV
	Relative mV Offset Range	±2000 mV
Temperature*	Range	-20.0 to 120.0°C (-4.0 to 248.0°F)
	Resolution	0.1°C (0.1°F)
	Accuracy	±0.4°C (±0.8°F) (excluding probe error)
Additional Specifications	pH Probe	FC2133 glass body, pH electrode with internal temperature sensor, quick DIN connector and 1 m (3.3' cable)
	Slope Calibration	from 80 to 110%
	Log-on-demand	Up to 200 samples (100 pH, 100 mV)
	PC Connection	opto-isolated USB with HI92000 software and micro USB cable
	Input Impedance	10 <sup>12</sup> Ω
	Battery Type / Life	1.5V AA batteries (4) / approximately 200 hours of continuous use without backlight (50 hours with backlight)
	Auto-off	user selectable: 5, 10, 30, 60 min, disabled
	Environment	0 to 50°C (32 to 122°F); RH 100% IP67
	Dimensions / Weight	185 x 93 x 35.2 mm (7.3 x 3.6 x 1.4") / 400 g (14.2 oz.)
	Ordering Information	HI98164 is supplied with FC2133 pH electrode, HI7004M pH 4.01 buffer solution (230 mL), HI7007M pH 7.01 buffer solution (230 mL), HI700643 electrode cleaning and disinfection solution sachet for yogurt products (2), 100 mL plastic beaker (2), HI92000 PC software, HI920015 micro USB cable, 1.5V AA batteries (4), quality certificate, and instruction manual in a hard carrying case with custom insert.
Accessories	HI710035 blue protective rubber boot	



- Optional shockproof silicon rubber boot
- Specially designed to protect your instrument from damage or impact

HI710035 Blue

\* Limits will be reduced to actual probe/sensor limits.

## pH / Temperature Probe for Yogurt

The FC2133 pH electrode is rugged and easy to clean with a conical tip and built-in temperature sensor. The open junction design consists of a solid gel interface (viscolene) between the sample and internal Ag/AgCl reference. This interface not only prevents silver from entering the sample, but also makes it impermeable to clogging after measurements in semi-solid or viscous samples. The FC2133 electrode is designed to prevent the typical problems of clogging in viscous liquids, ensuring a fast response and stable reading.

### Glass body

The glass body of the FC2133 allows standards and samples to more quickly reach thermal equilibrium while also providing chemical resistance.

### Low temperature glass

The FC2133 electrode uses Low Temperature (LT) glass for the sensing bulb. The LT glass tip is a lower resistance glass formulation. As the temperature of the sensing glass decreases, the resistance of the LT glass will increase approaching that of standard glass at ambient temperatures. The FC2133 is suitable to use with samples that measure from 0 to 50°C.

### Viscolene electrolyte

The viscolene electrolyte offers a hard gel interface between the inner electrode components and the sample being measured. The electrolyte is silver-free for use in yogurt and is maintenance-free.

### Open junction reference

Clogging of the reference junction is a common challenge faced by yogurt producers as the milk solids and proteins can easily build up on the electrode. The open junction design of the FC2133 resists clogging and continues to provide accurate, stable readings.

### Conic tip shape

This design allows for penetration into semisolids and emulsions for the direct measurement of pH in yogurt products.

### Built-in temperature sensor

A thermistor temperature sensor is in the tip of the indicating pH electrode. A temperature sensor should be as close as possible to the indicating pH bulb in order to compensate for variations in temperature.



Specifications	FC2133
Description	pre-amplified pH / temperature probe
Reference	double, Ag/AgCl
Junction	open
Electrolyte	viscolene
Max Pressure	0.1 bar
Range	pH: 0 to 12
Recommended Operating Temperature	0 to 50°C (32 to 122°F)
Glass Type	LT (low temperature)
Tip /Shape	conic
Temperature Sensor	yes
Amplifier	yes
Body Material	glass
Cable	coaxial; 1 m (3.3')
Connection	quick connect DIN

## Application Importance

Monitoring pH is crucial in producing consistent, quality yogurt. Yogurt is made by the fermentation of milk with live bacterial cultures. Following pasteurization and compositional adjustment, milk is homogenized for a consistent texture, heated to the desired thickness, and cooled before inoculation. Most yogurt is inoculated with a starter culture consisting of *Lactobacillus bulgaricus* and *Streptococcus thermophilus*. Once the live culture is added, the mixture of milk and bacteria is incubated, allowing for fermentation of lactose to lactic acid. As lactic acid is produced, there is a correlating drop in pH. Due to the more acidic mixture, the casein protein in milk coagulates and precipitates out, thickening the milk into a yogurt-like texture.

Yogurt producers cease incubation once a specific pH level is reached. Most producers have a set point between pH 4.0 and 4.6 in which fermentation is stopped by rapid cooling. The amount of lactic acid present at this pH level is ideal for yogurt, giving it the characteristic tartness, aiding in thickening, and acting as a preservative against undesirable strains of bacteria.

By verifying that fermentation continues to a predetermined pH endpoint, yogurt producers can ensure their products remain consistent in terms of flavor, aroma, and texture. A deviation from the predetermined pH can lead to a reduced shelf life of yogurt or create a product that is too bitter or tart. Syneresis is the separation of liquid, in this case whey, from the milk solids; this can occur if fermentation is stopped too early or too late, resulting in yogurt that is respectively too alkaline or too acidic. Consumers expect yogurt to remain texturally consistent, so ensuring fermentation is stopped at the appropriate pH is vital to consumer perception.

## Foodcare

HI98165

### pH / Temperature Meter for Cheese

HI98165 is a professional portable pH and temperature meter with a probe designed specifically for pH measurement in cheese.

- **Waterproof**
  - IP67 rated waterproof, rugged enclosure
- **CAL Check™**
  - Alerts users to problems during calibration including dirty/broken electrode, contaminated buffer, and overall probe condition
- **Automatic or manual temperature compensation**
  - pH sensors incorporate a built-in temperature sensor
- **Calibration**
  - Up to a five-point calibration with seven standard buffers and five custom buffers
- **Approximately 200 hour battery life**
  - Powered by four 1.5V AA batteries
- **Clear display**
  - Dot matrix display with multifunction virtual keys
- **Auto hold**
  - Automatically holds the first stable reading on the display
- **Calibration timeout**
  - Alerts when calibration is due at a specified interval
- **Connectivity**
  - PC connectivity via opto-isolated micro-USB with HI92000 software
- **GLP**
  - GLP data provides data from previous calibration to ensure Good Laboratory Practices are met
- **Intuitive keypad**
  - Important and often used functions such as GLP information, help, range, calibration, and backlight have a dedicated button
- **Supplied complete**
  - Each meter is supplied complete with sensor, calibration and cleaning solutions, beakers, PC software and connection cable, instruction manual, quick start guide, and batteries in a rugged, custom carrying case



pH

portable



# Cheese pH Meter

designed for food professionals

Hanna foodcare pH meters are rugged and portable with the performance and features of a benchtop. Eight models are available in this series to measure food, milk, meat, yogurt, cheese, beer, wine, and soil. Each model is supplied with an application specific electrode and cleaning solutions. These waterproof meters comply to IP67 standards and can be easily operated with one hand.



## Backlit Graphic LCD Display

These meters feature a backlit graphic LCD with on-screen help. The graphic display allows for the use of virtual keys to provide for an intuitive user interface.

## Waterproof Protection

The meter is enclosed in an IP67 rated waterproof casing and can withstand immersion in water at a depth of 1 m for up to 30 minutes.



## Quick Connect Probe

Each meter features an application specific pH/temperature probe with a quick connect DIN connector to make attaching and removing the probe simple and easy.

## Calibration Timeout

Alerts when calibration is due at a specified interval.

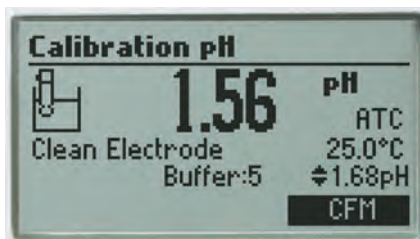

## pH Calibration

Choose from seven standard pH buffers and five custom values to obtain up to five point calibration and achieve high precision readings with a 0.001 pH resolution and a pH accuracy of  $\pm 0.002$ .

## Enhanced Calibration

An "out of calibration range" warning can be engaged to keep the user informed of the current calibration and help to avoid performing measurements that are out of the bracketed range.

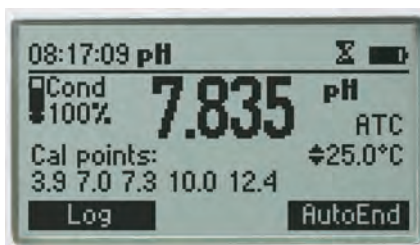

## CAL Check™

Hanna's CAL Check maintains a history of past calibrations and monitors the pH electrode and buffers during subsequent calibrations for any signs of wide variances due to a dirty or broken electrode or contaminated pH buffers. During calibration, users are alerted to problems should they occur. After calibration, the electrode's overall condition is displayed as a percentage.

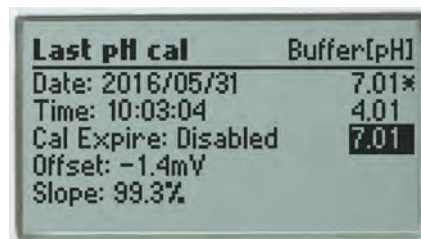

## GLP

Comprehensive GLP functions are directly accessible by pressing the GLP key. Calibration data, including date, time, and calibration values are stored with logged data for retrieval at a later time.



## Data Logging

The log-on-demand feature allows users to store up to 200 samples that can later be transferred to a PC with the HI920015 USB cable and HI92000 software.

## Automatic Temperature Compensation

pH sensors incorporate a built-in temperature sensor in the tip of the electrode for a fast and accurate temperature compensated value.

## Intuitive Keypad

The fitted rubber keypad has dedicated keys for many important and often used functions. These meters also feature two virtual soft keys that navigate the user through setup and logging of data. The interface is intuitive for any user's level of experience.

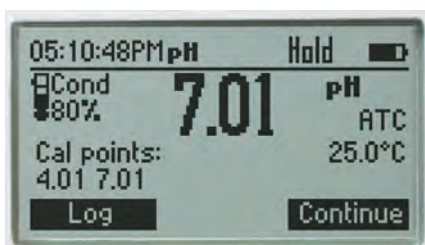

### Auto Hold

Pressing AutoEnd during measurement will automatically hold the first stable reading on the display.



### Dedicated Help Key

Contextual help is always available through a dedicated "HELP" key. Clear tutorial messages and directions are available on-screen to quickly and easily guide users through setup and calibration. The help information displayed is relative to the setting/option being viewed.



### Setup Screen

Our extensive setup screen features a host of configurable options such as time, date, temperature units, and language for help screens and guides.



### PC Connectivity

Logged data can be transferred to a Windows compatible PC with the included HI920015 micro USB cable and HI92000 software.

### Long Battery Life

The display of the meter has a battery icon indicator to show the remaining power. The meter uses four 1.5V AA batteries that provide up to 200 hours of battery life.



### Supplied Complete in a Rugged Custom Carrying Case

Each meter is supplied complete with sensor, calibration and cleaning solutions, beakers, PC software and connection cable, instruction manual, quick start guide, and batteries in a rugged, custom carrying case. The inside compartment of the carrying case is thermoformed to securely hold and protect all of the components.

Specifications	HI98165	
pH*	Range	-2.0 to 20.0 pH; -2.00 to 20.00 pH; -2.000 to 20.000 pH
	Resolution	0.1 pH; 0.01 pH; 0.001 pH
	Accuracy	±0.1 pH; ±0.01 pH; ±0.002 pH
	Calibration	up to five-point calibration, seven standard buffers available (1.68, 4.01, 6.86, 7.01, 9.18, 10.01, 12.45) and five custom buffers
	Temperature Compensation	automatic or manual from -20.0 to 120.0°C (-4.0 to 248.0°F)
mV	Range	±2000 mV
	Resolution	0.1 mV
	Accuracy	±0.2 mV
	Relative mV Offset Range	±2000 mV
Temperature*	Range	-20.0 to 120.0 °C (-4.0 to 248.0°F)
	Resolution	0.1°C (0.1°F)
	Accuracy	±0.4°C (±0.8°F) (excluding probe error)
Additional Specifications	pH Probe	FC2423 pre-amplified pH and temperature probe with titanium sheath, pH electrode with internal temperature sensor, quick DIN connector and 1 m (3.3' cable)
	Slope Calibration	from 80 to 110%
	Log-on-demand	Up to 200 samples (100 pH, 100 mV)
	PC Connection	opto-isolated USB with HI92000 software and micro USB cable
	Input Impedance	10 <sup>12</sup> Ω
	Battery Type / Life	1.5V AA batteries (4) / approximately 200 hours of continuous use without backlight (50 hours with backlight)
	Auto-off	user selectable: 5, 10, 30, 60 min, disabled
	Environment	0 to 50°C (32 to 122°F); RH 100% IP67
	Dimensions / Weight	185 x 93 x 35.2 mm (7.3 x 3.6 x 1.4") / 400 g (14.2 oz.)
	Ordering Information	<b>HI98165</b> is supplied with FC2423 pH electrode, HI7004M pH 4.01 buffer solution (230 mL), HI7007M pH 7.01 buffer solution (230 mL), HI700642 electrode cleaning solution sachet for cheese residues (2), 100 mL plastic beaker (2), HI92000 PC software, HI920015 micro USB cable, 1.5V AA batteries (4), quality certificate, and instruction manual in a hard carrying case with custom insert.
Accessories	<b>HI710035</b> blue protective rubber boot	
	<b>HI720165</b> Replacement carrying case for HI98165	



- **Optional shockproof silicon rubber boot**
  - Specially designed to protect your instrument from damage or impact

**HI710035** Blue

\* Limits will be reduced to actual probe/sensor limits.

# pH / Temperature Probe for Cheese

FC2423 electrode has a titanium sheath and conical tip to ensure quick, easy measurements, and fast response. FC2423 pH electrode features a built-in temperature sensor and is ideal for measurements in semi-solid samples such as cheeses.

## Low temperature glass

The FC2423 electrode uses Low Temperature (LT) glass for the sensing bulb. The LT glass tip is a lower resistance glass formulation. As the temperature of the sensing glass decreases, the resistance of the LT glass will increase approaching that of standard glass at ambient temperatures. The FC2423 is suitable to use with samples that measure from 0 to 50°C.

## Titanium body

The titanium body offers durability in the production facility and can withstand chloride concentrations that cause corrosion in other types of alloys.

## Viscolene electrolyte

The viscolene electrolyte offers a hard gel interface between the inner electrode components and the sample being measured. The electrolyte is silver-free for use in cheese products and is maintenance-free.

## Built-in temperature sensor

A thermistor temperature sensor is in the tip of the indicating pH electrode. A temperature sensor should be as close as possible to the indicating pH bulb in order to compensate for variations in temperature.

## Conic tip shape

This design allows for penetration into solids, semi solids, and emulsions for the direct measurement of pH in cheese products.



Specifications	FC2423
Description	pre-amplified pH / temperature probe
Reference	single, Ag/AgCl
Junction	open
Electrolyte	viscolene
Max Pressure	0.1 bar
Range	pH: 0 to 12
Recommended Operating Temperature	0 to 50°C (32 to 122°F)
Glass Type	LT (low temperature)
Tip / Shape	conic
Temperature Sensor	yes
Amplifier	yes
Body Material	titanium
Cable	coaxial; 1 m (3.3')
Connection	quick connect DIN

## Application Importance

pH is an essential measurement throughout the entire cheesemaking process. From the initial measurements of incoming milk to the final measurements of ripened cheese, pH is the most important parameter for cheese quality and safety control.

Acidification of milk begins with the addition of bacterial culture and rennet. The bacteria consume lactose and create lactic acid as a byproduct of fermentation, lowering the pH of the milk. Once the milk reaches a particular pH, the rennet is added. The enzymes in rennet help to speed up curdling and create a firmer substance. For cheesemakers that dilute their rennet, the pH of the dilution water is also critical; water that is near pH 7 or higher can deactivate the rennet, causing problems with coagulation.

Once the curds are cut, stirred, and cooked, the liquid whey must be drained. The pH of whey at draining directly affects the composition and texture of the final cheese product. Whey that has a relatively high pH contributes to higher levels of calcium and phosphate and results in a stronger curd. Typical pH levels at draining can vary depending on the type of cheese; for example, Swiss cheese is drained between pH 6.3 and 6.5 while Cheddar cheese is drained between pH 6.0 and 6.2.

The next stages of milling and salting are affected by pH as well. During milling, curds are cut into smaller pieces to prepare the cheese for salting. Curds with a lower pH at milling result in a harder cheese. A low pH will also result in higher salt absorption during the salting stage.

When curds are pressed into a final, solid form, the pH directly affects how well the curds fuse together. If the pH is too high during pressing, the curds will not bind together as well and the final cheese will have a more open texture.

During brining, the cheese soaks up salt from the brine solution and loses excess moisture. The pH of the brine solution should be close to the pH of the cheese, ensuring equilibrium of ions like calcium and hydrogen. If there is an imbalance during brining, the final product can have rind defects, discoloration, a weakened texture, and a shorter shelf life.

Cheeses must fall within a narrow pH range to provide an optimal environment for microbial and enzymatic processes that occur during ripening. Bacterial cultures used in ripening are responsible for characteristics like the holes in Swiss cheese, the white mold on Brie rinds, and the aroma of Limburger cheese. A deviation from the ideal pH is not only detrimental to the ecology of the bacteria, but also to the cheese structure. Higher pH levels can result in cheeses that are more elastic while lower pH levels can cause brittleness.

HI98167

## pH / Temperature Meter for Beer

The HI98167 is a rugged, waterproof, portable pH meter that measures pH and temperature during the brewing process. This meter is supplied with a specialized titanium body pH electrode with a built in temperature sensor that is ideal for measuring the pH of mash, cooled wort, and of the finished product.

- **Waterproof**
  - IP67 rated waterproof, rugged enclosure
- **CAL Check™**
  - Alerts users to problems during calibration including dirty/broken electrode, contaminated buffer, and overall probe condition
- **Automatic or manual temperature compensation**
  - pH sensors incorporate a built-in temperature sensor
- **Calibration**
  - Up to a five-point calibration with seven standard buffers and five custom buffers
- **Approximately 200 hour battery life**
  - Powered by four 1.5V AA batteries
- **Clear display**
  - Dot matrix display with multifunction virtual keys
- **Auto hold**
  - Automatically holds the first stable reading on the display
- **Calibration timeout**
  - Alerts when calibration is due at a specified interval
- **Connectivity**
  - PC connectivity via opto-isolated micro-USB with HI92000 software
- **GLP**
  - GLP data provides data from previous calibration to ensure Good Laboratory Practices are met
- **Intuitive keypad**
  - Important and often used functions such as GLP information, help, range, calibration and backlight have a dedicated button
- **Supplied complete**
  - Each meter is supplied complete with sensor, calibration and cleaning solutions, beakers, PC software and connection cable, instruction manual, quick start guide, and batteries in a rugged, custom carrying case



pH

portable

# Beer pH Meter

designed for beer making professionals

Hanna foocare pH meters are rugged and portable with the performance and features of a benchtop. Eight models are available in this series to measure food, milk, meat, yogurt, cheese, beer, wine, and soil. Each model is supplied with an application specific electrode and cleaning solutions. These waterproof meters comply to IP67 standards and can be easily operated with one hand.



## Backlit Graphic LCD Display

These meters feature a backlit graphic LCD with on-screen help. The graphic display allows for the use of virtual keys to provide for an intuitive user interface.

## Waterproof Protection

The meter is enclosed in an IP67 rated waterproof casing and can withstand immersion in water at a depth of 1 m for up to 30 minutes.



## Quick Connect Probe

Each meter features an application specific pH/temperature probe with a quick connect DIN connector to make attaching and removing the probe simple and easy.

## Calibration Timeout

Alerts when calibration is due at a specified interval.

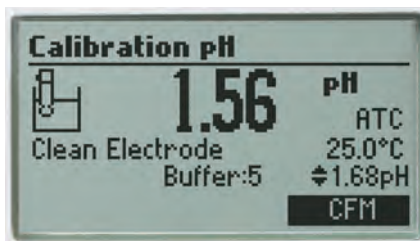

## pH Calibration

Choose from seven standard pH buffers and five custom values to obtain up to five point calibration and achieve high precision readings with a 0.001 pH resolution and a pH accuracy of  $\pm 0.002$ .

## Enhanced Calibration

An "out of calibration range" warning can be engaged to keep the user informed of the current calibration and help to avoid performing measurements that are out of the bracketed range.

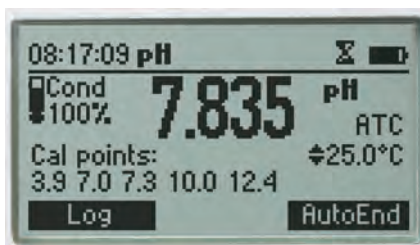

## CAL Check™

Hanna's CAL Check maintains a history of past calibrations and monitors the pH electrode and buffers during subsequent calibrations for any signs of wide variances due to a dirty or broken electrode or contaminated pH buffers. During calibration, users are alerted to problems should they occur. After calibration, the electrode's overall condition is displayed as a percentage.

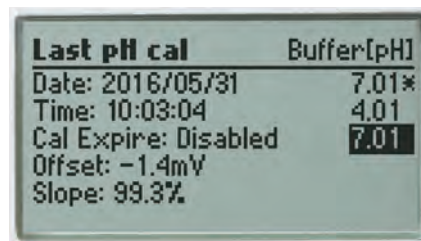

## GLP

Comprehensive GLP functions are directly accessible by pressing the GLP key. Calibration data, including date, time, and calibration values are stored with logged data for retrieval at a later time.



## Data Logging

The log-on-demand feature allows users to store up to 200 samples that can later be transferred to a PC with the HI920015 USB cable and HI92000 software.

## Automatic Temperature Compensation

pH sensors incorporate a built-in temperature sensor in the tip of the electrode for a fast and accurate temperature compensated value.

## Intuitive Keypad

The fitted rubber keypad has dedicated keys for many important and often used functions. These meters also feature two virtual soft keys that navigate the user through setup and logging of data. The interface is intuitive for any user's level of experience.

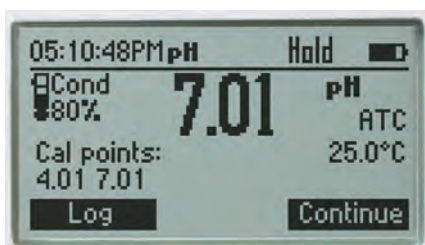

### Auto Hold

Pressing AutoEnd during measurement will automatically hold the first stable reading on the display.



### Dedicated Help Key

Contextual help is always available through a dedicated "HELP" key. Clear tutorial messages and directions are available on-screen to quickly and easily guide users through setup and calibration. The help information displayed is relative to the setting/option being viewed.



### Setup Screen

Our extensive setup screen features a host of configurable options such as time, date, temperature units, and language for help screens and guides.



### PC Connectivity

Logged data can be transferred to a Windows compatible PC with the included HI920015 micro USB cable and HI92000 software.

### Long Battery Life

The display of the meter has a battery icon indicator to show the remaining power. The meter uses four 1.5V AA batteries that provide up to 200 hours of battery life.



### Supplied Complete in a Rugged Custom Carrying Case

Each meter is supplied complete with sensor, calibration and cleaning solutions, beakers, PC software and connection cable, instruction manual, quick start guide, and batteries in a rugged, custom carrying case. The inside compartment of the carrying case is thermoformed to securely hold and protect all of the components.

Specifications	HI98167	
pH*	Range	-2.0 to 20.0 pH; -2.00 to 20.00 pH; -2.000 to 20.000 pH
	Resolution	0.1 pH; 0.01 pH; 0.001 pH
	Accuracy	±0.1 pH; ±0.01 pH; ±0.002 pH
	Calibration	up to five-point calibration, seven standard buffers available (1.68, 4.01, 6.86, 7.01, 9.18, 10.01, 12.45) and five custom buffers
	Temperature Compensation	automatic or manual from -20.0 to 120.0°C (-4.0 to 248.0°F)
mV	Range	±2000 mV
	Resolution	0.1 mV
	Accuracy	±0.2 mV
	Relative mV Offset Range	±2000 mV
Temperature*	Range	-20.0 to 120.0 °C (-4.0 to 248.0°F)
	Resolution	0.1°C (0.1°F)
	Accuracy	±0.4°C (±0.8°F) (excluding probe error)
Additional Specifications	pH Probe	FC2143 Titanium body, flat tip, preamplified pH electrode with internal temperature sensor, quick DIN connector and 1 m (3.3' cable)
	Slope Calibration	from 80 to 110%
	Log-on-demand	Up to 200 samples (100 pH, 100 mV)
	PC Connection	opto-isolated USB with HI92000 software and micro USB cable
	Input Impedance	10 <sup>12</sup> Ω
	Battery Type / Life	1.5V AA batteries (4) / approximately 200 hours of continuous use without backlight (50 hours with backlight)
	Auto-off	user selectable: 5, 10, 30, 60 min, disabled
	Environment	0 to 50°C (32 to 122°F); RH 100% IP67
	Dimensions / Weight	185 x 93 x 35.2 mm (7.3 x 3.6 x 1.4") / 400 g (14.2 oz.)
	Ordering Information	HI98167 is supplied with FC2143 pH electrode, HI7004M pH 4.01 buffer solution (230 mL), HI7007M pH 7.01 buffer solution (230 mL), HI700682 Electrode cleaning solution sachets for brewing deposits (2), 100 mL plastic beaker (2), HI92000 PC software, HI920015 micro USB cable, 1.5V AA batteries (4), instruction manual, and quality certificate in a HI720161 hard carrying case with custom insert.
Accessories	HI710035 blue protective rubber boot	



- Optional shockproof silicon rubber boot
- Specially designed to protect your instrument from damage or impact

HI710035 Blue

\* Limits will be reduced to actual probe/sensor limits.

FC2143

## pH / Temperature Probe for Beer

The FC2143 pH electrode is a flat tip pH sensor made with specialized glass to provide a long life when measuring temperatures up to 80°C. A built in temperature sensor compensates for temperature variations. The probe has a built in amplifier and a titanium body that acts as a matching pin to reduce noise as a result from the effect that humidity has on probe connection to the meter. The FC2143 connects to the HI98167 with a quick-connect, waterproof DIN connector, allowing for a secure, non-threaded attachment.

### Titanium Body

A pH measurement is a very sensitive voltage measurement that is susceptible to interference. To reduce this susceptibility the titanium body serves as a matching pin. A matching pin is a differential measurement technique used to eliminate electrical noise in the measurement system.

### Flat Tip pH Sensor

The flat tip sensor allows for easy cleaning of the pH sensing surface as solids from mash and cooled wort collect on the surface.

### Quick Connect DIN Connector

This secure waterproof connector allows for a single cable to be used for both pH and temperature measurements.

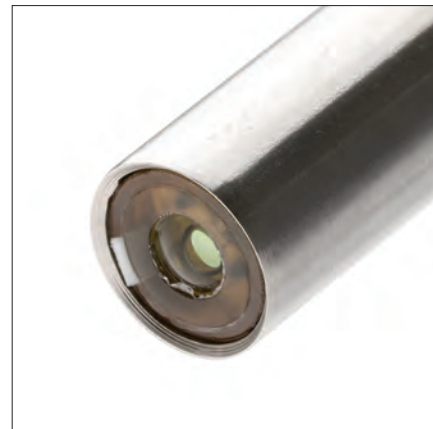

## Application Importance

The measurement of pH during the beer making process is important due to the effect it has on enzymatic activity in the mash, yeast activity in fermentation, and the incorporation of flavoring components. Monitoring and controlling the pH allows for a consistent flavor profile and ensures a stable product. The brewer is faced with a number of challenges when measuring pH. The mash has a high content of semi-solids and sugars are formed from the conversion of starch by enzymatic activity. Both can pose problems, including coating the glass and clogging the junction. The mash and cooled wort after boiling are typically above room temperature, which leads to the degradation of the sensitive glass. To overcome these challenges the HI98167 beer pH meter is supplied with a uniquely design titanium body pH electrode.

Specifications	FC2143
Description	pH electrode
Reference	single, Ag/AgCl
Junction	cloth
Electrolyte	gel
Max Pressure	3 bar
Range	pH: 0 to 12
Recommended Operating Temperature	0 to 80°C (32 to 176°F)
Glass Type	LT (low temperature)
Tip /Shape	flat
Temperature Sensor	yes
Amplifier	yes
Body Material	titanium with HT glass sensor
Cable	coaxial; 1 m (3.3')
Connection	quick connect DIN

## Foodcare

HI98169

### pH / Temperature Meter for Wine

HI98169 is a rugged, waterproof, portable pH meter that measures pH and temperature of must in winemaking. This meter is supplied with a specialized pH probe that features an open junction with Clogging Prevention System (CPS™) technology.

- **Waterproof**
  - IP67 rated waterproof, rugged enclosure
- **CAL Check™**
  - Alerts users to problems during calibration including dirty/broken electrode, contaminated buffer and overall probe condition
- **Automatic or manual temperature compensation**
  - pH sensors incorporate a built-in temperature sensor
- **Calibration**
  - Up to a five-point calibration with seven standard buffers and five custom buffers
- **Approximately 200 hour battery life**
  - Powered by four 1.5V AA batteries
- **Clear display**
  - Dot matrix display with multifunction virtual keys
- **Auto hold**
  - Automatically holds the first stable reading on the display
- **Calibration timeout**
  - Alerts when calibration is due at a specified interval
- **Connectivity**
  - PC connectivity via opto-isolated micro-USB with HI92000 software
- **GLP**
  - GLP data provides data from previous calibration to ensure Good Laboratory Practices are met
- **Intuitive keypad**
  - Important and often used functions such as GLP information, help, range, calibration and backlight have a dedicated button
- **Supplied complete**
  - Each meter is supplied complete with sensor, calibration and cleaning solutions, beakers, PC software and connection cable, instruction manual, quick start guide, and batteries in a rugged, custom carrying case



pH

portable



# Wine pH Meter

designed for wine making professionals

Hanna foodcare pH meters are rugged and portable with the performance and features of a benchtop. Eight models are available in this series to measure food, milk, meat, yogurt, cheese, beer, wine, and soil. Each model is supplied with an application specific electrode and cleaning solutions. These waterproof meters comply to IP67 standards and can be easily operated with one hand.



## Backlit Graphic LCD Display

These meters feature a backlit graphic LCD with on-screen help. The graphic display allows for the use of virtual keys to provide for an intuitive user interface.

## Waterproof Protection

The meter is enclosed in an IP67 rated waterproof casing and can withstand immersion in water at a depth of 1 m for up to 30 minutes.



## Quick Connect Probe

Each meter features an application specific pH/temperature probe with a quick connect DIN connector to make attaching and removing the probe simple and easy.

## Calibration Timeout

Alerts when calibration is due at a specified interval.

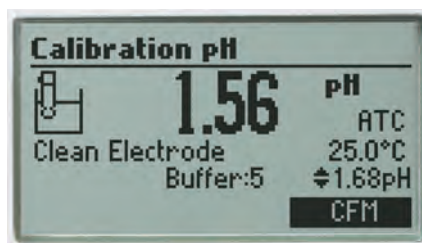

## pH Calibration

Choose from seven standard pH buffers and five custom values to obtain up to five point calibration and achieve high precision readings with a 0.001 pH resolution and a pH accuracy of  $\pm 0.002$ .

## Enhanced Calibration

An "out of calibration range" warning can be engaged to keep the user informed of the current calibration and help to avoid performing measurements that are out of the bracketed range.



## CAL Check™

Hanna's CAL Check maintains a history of past calibrations and monitors the pH electrode and buffers during subsequent calibrations for any signs of wide variances due to a dirty or broken electrode or contaminated pH buffers. During calibration, users are alerted to problems should they occur. After calibration, the electrode's overall condition is displayed as a percentage.

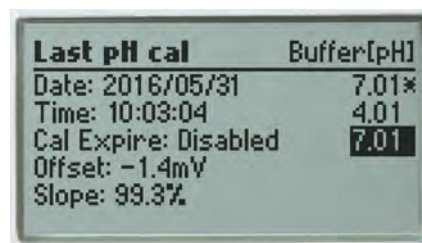

## GLP

Comprehensive GLP functions are directly accessible by pressing the GLP key. Calibration data, including date, time, and calibration values are stored with logged data for retrieval at a later time.



## Data Logging

The log-on-demand feature allows users to store up to 200 samples that can later be transferred to a PC with the HI920015 USB cable and HI92000 software.

## Automatic Temperature Compensation

pH sensors incorporate a built-in temperature sensor in the tip of the electrode for a fast and accurate temperature compensated value.

## Intuitive Keypad

The fitted rubber keypad has dedicated keys for many important and often used functions. These meters also feature two virtual soft keys that navigate the user through setup and logging of data. The interface is intuitive for any user's level of experience.

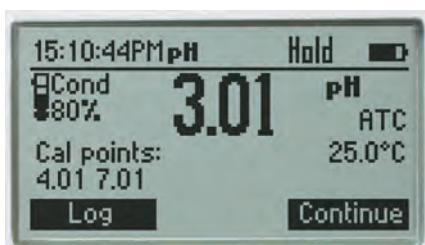

### Auto Hold

Pressing AutoEnd during measurement will automatically hold the first stable reading on the display.



### Dedicated Help Key

Contextual help is always available through a dedicated "HELP" key. Clear tutorial messages and directions are available on-screen to quickly and easily guide users through setup and calibration. The help information displayed is relative to the setting/option being viewed.



### Setup Screen

Our extensive setup screen features a host of configurable options such as time, date, temperature units, and language for help screens and guides.



### PC Connectivity

Logged data can be transferred to a Windows compatible PC with the included HI920015 micro USB cable and HI92000 software.

### Long Battery Life

The display of the meter has a battery icon indicator to show the remaining power. The meter uses four 1.5V AA batteries that provide up to 200 hours of battery life.



### Supplied Complete in a Rugged Custom Carrying Case

Each meter is supplied complete with sensor, calibration and cleaning solutions, beakers, PC software and connection cable, instruction manual, quick start guide, and batteries in a rugged, custom carrying case. The inside compartment of the carrying case is thermoformed to securely hold and protect all of the components.

Specifications	HI98169	
pH*	Range	-2.0 to 20.0 pH; -2.00 to 20.00 pH; -2.000 to 20.000 pH
	Resolution	0.1 pH; 0.01 pH; 0.001 pH
	Accuracy	±0.1 pH; ±0.01 pH; ±0.002 pH
	Calibration	up to five-point calibration, seven standard buffers available (1.68, 4.01, 6.86, 7.01, 9.18, 10.01, 12.45) and five custom buffers
	Temperature Compensation	automatic or manual from -20.0 to 120.0°C (-4.0 to 248.0°F)
mV	Range	±2000 mV
	Resolution	0.1 mV
	Accuracy	±0.2 mV
	Relative mV Offset Range	±2000 mV
Temperature*	Range	-20.0 to 120.0 °C (-4.0 to 248.0°F)
	Resolution	0.1°C (0.1°F)
	Accuracy	±0.4°C (±0.8°F) (excluding probe error)
Additional Specifications	pH Probe	FC10483 preamplified pH and temperature probe with flat tip, DIN connector and 1 m (3.3') cable
	Slope Calibration	from 80 to 110%
	Log-on-demand	Up to 200 samples (100 pH, 100 mV)
	PC Connection	opto-isolated USB with HI92000 software and micro USB cable
	Input Impedance	10 <sup>12</sup> Ω
	Battery Type / Life	1.5V AA batteries (4) / approximately 200 hours of continuous use without backlight (50 hours with backlight)
	Auto-off	user selectable: 5, 10, 30, 60 min, disabled
	Environment	0 to 50°C (32 to 122°F); RH 100% IP67
	Dimensions / Weight	185 x 93 x 35.2 mm (7.3 x 3.6 x 1.4") / 400 g (14.2 oz)
	Ordering Information	<b>HI98169</b> is supplied with FC10483 pH electrode, pH 3.00 buffer solution sachets (2), pH 7.01 buffer solution sachets (2), HI700635 Cleaning solution for wine deposits sachet, HI700636 cleaning solution for wine stains sachet, 100 mL plastic beaker (2), HI920015 micro USB cable, 1.5V AA batteries (4), instruction manual, guidebook for winemakers, and quality certificate in a HI720169 hard carrying case with custom insert.
Accessories	<b>HI710035</b> blue protective rubber boot	

## FC10483 pH electrode

- PE sleeve
- Refillable pH electrode
- Clogging prevention system (CPS™)

The HI98169 portable pH meter for wine uses the glass body FC10483 pH electrode with Hanna's unique Clogging Prevention System (CPS™). This electrode provides a fast stable response and resists clogging. The electrolyte solution in the electrode is refillable.

An integral part of any pH electrode is the reference junction. The reference junction is a part of the electrode that allows for the flow of ions located in the reference cell into the sample being measured. The ions provide for an electrical connection between the reference electrode and the indicating electrode. A standard pH electrode will use a single ceramic junction; however, the CPS™ (Clogging Prevention System) is an innovation in electrode technology. Conventional pH electrodes use ceramic junctions that clog quickly when used in wine. When the junction is clogged, the electrode does not function. CPS™ technology utilizes the porousness of ground glass coupled with a PE sleeve to prevent clogging of the junction. The ground glass allows proper flow of the liquid, while the PE sleeve repels dirt. As a result, pH electrodes with CPS™ stay fresh up to 20 times longer than conventional electrodes.

To optimize the flow from the electrode the refill cap should be unscrewed so that it is open. This allows for positive head pressure to be created allowing for the electrolyte to drain more easily from the reference electrode.



pH

portable

### The Importance of pH in Wine Making

The pH of wine is important to determine because it will affect the quality of the final product in terms of taste, color, oxidation, chemical stability and other factors. Generally in winemaking, the higher the pH reading, the lower amount of acidity in the wine. Three important factors in determining the pH of wine include the ratio of malic acid to tartaric acid, the amount of potassium, and the total amount of acid present.

Most wines optimally have a pH between 2.9 and 4.0, with values differing based on the type of wine. Values above pH 4.0 indicate that the wine may spoil quickly and be chemically unstable. Lower pH values allow the wine to stay fresher for a longer period and retain its original color and flavor. High pH wine is more likely to breed bacteria and become unsuitable to drink.

For finished white wines, the ideal pH is between pH 3.00 and pH 3.30, while the final pH for red wine is ideally between pH 3.40 and pH 3.50. The optimal pH before the fermentation process is between pH 2.9 and pH 4.0. The pH of wine therefore not only affects the color of wine, but also the oxidation, yeast fermentation, protein stability, and bacterial growth and fermentation.

Specifications	FC10483
Description	pH electrode
Reference	double, Ag/AgCl
Junction	CPS™
Electrolyte	KCl 3.5M
Max Pressure	0.1 bar
Range	pH: 0 to 12
Recommended Operating Temperature	-5 to 60°C (23 to 140°F)
Glass Type	LT (low temperature)
Tip /Shape	Dome (dia: 8 mm)
Temperature Sensor	yes
Amplifier	yes
Body Material	glass
Cable	coaxial; 1 m (3.3')
Connection	quick connect DIN

HI98168

## pH / Temperature Meter for Soil

The HI98168 is a rugged, waterproof, portable pH meter that allows for the direct measure of soil pH. This meter is supplied with a specialized pH electrode that has a rugged conical tip for insertion in soil.

- **Waterproof**
  - IP67 rated waterproof, rugged enclosure
- **CAL Check™**
  - Alerts users to problems during calibration including dirty/broken electrode, contaminated buffer, and overall probe condition
- **Automatic or manual temperature compensation**
  - pH sensors incorporate a built-in temperature sensor
- **Calibration**
  - Up to a five-point calibration with seven standard buffers and five custom buffers
- **Approximately 200 hour battery life**
  - Powered by four 1.5V AA batteries
- **Clear display**
  - Dot matrix display with multifunction virtual keys
- **Auto hold**
  - Automatically holds the first stable reading on the display
- **Calibration timeout**
  - Alerts when calibration is due at a specified interval
- **Connectivity**
  - PC connectivity via opto-isolated micro-USB with HI92000 software
- **GLP**
  - GLP data provides data from previous calibration to ensure Good Laboratory Practices are met
- **Intuitive keypad**
  - Important and often used functions such as GLP information, help, range, calibration, and backlight have a dedicated button
- **Supplied complete**
  - Each meter is supplied complete with sensor, calibration and cleaning solutions, beakers, PC software and connection cable, instruction manual, quick start guide, and batteries in a rugged, custom carrying case



# Soil pH Meter

designed for agriculture professionals

Hanna 98 series quality pH meters are rugged and portable with the performance and features of a benchtop. Seven models are available in this series to measure food, milk, meat, yogurt, cheese, beer, wine, and soil. Each model is supplied with an application specific electrode and cleaning solutions. These waterproof meters comply to IP67 standards and can be easily operated with one hand.



## Backlit Graphic LCD Display

These meters feature a backlit graphic LCD with on-screen help. The graphic display allows for the use of virtual keys to provide for an intuitive user interface.

## Waterproof Protection

The meter is enclosed in an IP67 rated waterproof casing and can withstand immersion in water at a depth of 1 m for up to 30 minutes.



## Quick Connect Probe

Each meter features an application specific pH/temperature probe with a quick connect DIN connector to make attaching and removing the probe simple and easy.

## Calibration Timeout

Alerts when calibration is due at a specified interval.

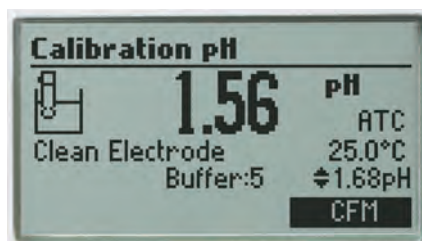

## pH Calibration

Choose from seven standard pH buffers and five custom values to obtain up to five point calibration and achieve high precision readings with a 0.001 pH resolution and a pH accuracy of  $\pm 0.002$ .

## Enhanced Calibration

An "out of calibration range" warning can be engaged to keep the user informed of the current calibration and help to avoid performing measurements that are out of the bracketed range.

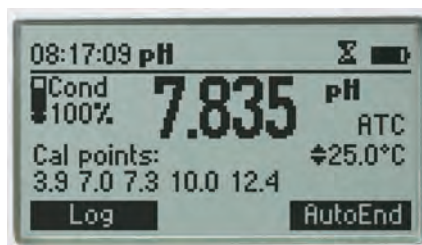

## CAL Check™

Hanna's CAL Check maintains a history of past calibrations and monitors the pH electrode and buffers during subsequent calibrations for any signs of wide variances due to a dirty or broken electrode or contaminated pH buffers. During calibration, users are alerted to problems should they occur. After calibration, the electrode's overall condition is displayed as a percentage.



## GLP

Comprehensive GLP functions are directly accessible by pressing the GLP key. Calibration data, including date, time, and calibration values are stored with logged data for retrieval at a later time.



## Data Logging

The log-on-demand feature allows users to store up to 200 samples that can later be transferred to a PC with the HI920015 USB cable and HI92000 software.

## Automatic Temperature Compensation

pH sensors incorporate a built-in temperature sensor in the tip of the electrode for a fast and accurate temperature compensated value.

## Intuitive Keypad

The fitted rubber keypad has dedicated keys for many important and often used functions. These meters also feature two virtual soft keys that navigate the user through setup and logging of data. The interface is intuitive for any user's level of experience.

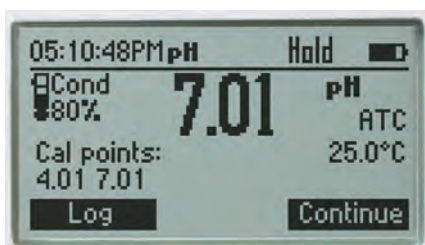

### Auto Hold

Pressing AutoEnd during measurement will automatically hold the first stable reading on the display.



### Dedicated Help Key

Contextual help is always available through a dedicated "HELP" key. Clear tutorial messages and directions are available on-screen to quickly and easily guide users through setup and calibration. The help information displayed is relative to the setting/option being viewed.



### Setup Screen

Our extensive setup screen features a host of configurable options such as time, date, temperature units and language for help screens and guides.



### PC Connectivity

Logged data can be transferred to a Windows compatible PC with the included HI920015 micro USB cable and HI92000 software.

### Long Battery Life

The display of the meter has a battery icon indicator to show the remaining power. The meter uses four 1.5V AA batteries that provide up to 200 hours of battery life.



### Supplied Complete in a Rugged Custom Carrying Case

Each meter is supplied complete with sensor, calibration and cleaning solutions, beakers, PC software and connection cable, instruction manual, quick start guide and batteries in a rugged, custom carrying case. The inside compartment of the carrying case is thermoformed to securely hold and protect all of the components.

Specifications	HI98168	
pH*	Range	-2.0 to 20.0 pH; -2.00 to 20.00 pH; -2.000 to 20.000 pH
	Resolution	0.1 pH; 0.01 pH; 0.001 pH
	Accuracy	±0.1 pH; ±0.01 pH; ±0.002 pH
	Calibration	up to five-point calibration, seven standard buffers available (1.68, 4.01, 6.86, 7.01, 9.18, 10.01, 12.45) and five custom buffers
	Temperature Compensation	automatic or manual from -20.0 to 120.0°C (-4.0 to 248.0°F)
mV	Range	±2000 mV
	Resolution	0.1 mV
	Accuracy	±0.2 mV
	Relative mV Offset Range	±2000 mV
Temperature*	Range	-20.0 to 120.0 °C (-4.0 to 248.0°F)
	Resolution	0.1°C (0.1°F)
	Accuracy	±0.4°C (±0.8°F) (excluding probe error)
Additional Specifications	pH Probe	HI12923 Glass body, conical tip, refillable pH electrode with internal temperature sensor, quick DIN connector and 1 m (3.3' cable)
	Slope Calibration	from 80 to 110%
	Log-on-demand	Up to 200 samples (100 pH, 100 mV)
	PC Connection	opto-isolated USB with HI92000 software and micro USB cable
	Input Impedance	10 <sup>12</sup> Ω
	Battery Type / Life	1.5V AA batteries (4) / approximately 200 hours of continuous use without backlight (50 hours with backlight)
	Auto-off	user selectable: 5, 10, 30, 60 min, disabled
	Environment	0 to 50°C (32 to 122°F); RH 100% IP67
	Dimensions / Weight	185 x 93 x 35.2 mm (7.3 x 3.6 x 1.4") / 400 g (14.2 oz.)
	Ordering Information	<b>HI98168</b> is supplied with HI12923 pH electrode, HI721319 ground auger, HI7004M pH 4.01 buffer solution (230 mL), HI7007M pH 7.01 buffer solution (230 mL), HI700663 Cleaning solution sachet for soil deposits, HI700664 Cleaning solution for humus deposits, HI7051M Soil Test Solution (230 mL), 100 mL plastic beaker (2), HI92000 PC software, HI920015 micro USB cable, 1.5V AA batteries (4), instruction manual, and quality certificate in a HI720161 hard carrying case with custom insert.



- Optional shockproof silicon rubber boot
- Specially designed to protect your instrument from damage or impact

**HI710035** Blue

HI12923

## pH / Temperature Probe for Soil

The HI12923 pH electrode that is supplied with the HI98168 is uniquely designed with a conical tip and a triple ceramic junction for improved performance in soils that have a low moisture content. The probe has a built in amplifier to reduce noise from humidity that can effect the probe connection to the meter. The HI12923 connects to the HI98168 with a quick-connect, waterproof DIN connector, allowing for a secure, non-threaded attachment.

### Refillable

As electrolyte is lost over time it can be replenished to extend the life of the electrode.

### Triple ceramic junction

The outer reference has three ceramic frits that allow electrolyte to flow at a high rate from the inside of the probe to the outside. A higher flow rate allows for a pH measurement of soil with low moisture.

### Conical Tip

The conical tip is made of durable low temperature glass and allows for direct measurement in soils. In the case any rocks are present an auger is provided to make a hole for the probe.

### Quick Connect DIN Connector

This secure waterproof connector allows for a single cable to be used for both pH and temperature measurements.



Specifications	HI12923
Description	pH electrode
Reference	single, Ag/AgCl
Junction	ceramic, triple / 40-50 µL/h
Electrolyte	KCl 3.5M + AgCl
Max Pressure	0.1 bar
Range	pH: 0 to 12
Recommended Operating Temperature	-5 to 70°C (23 to 158°F) - LT
Glass Type	LT (low temperature)
Tip /Shape	conic (12 x 12 mm)
Temperature Sensor	yes
Amplifier	yes
Body Material	glass
Cable	coaxial; 1 m (3.3')
Connection	quick connect DIN

## Application Importance

The measurement of pH in agricultural activities is very important due to the influence it has on the growth of the plant. Soil can be acid, neutral or alkaline, according to its pH value. Most plants prefer a pH range from 5.5 to 7.5; but some species prefer more acid or alkaline soils. Nevertheless, every plant requires a particular range of pH for optimum growth.

2

pH

portable

## 99 Series Portable Waterproof Meters

For scientists and professionals who require precision in the field or on the production floor, Hanna's 99 Series meters are durable, water-proof handhelds that deliver accurate results. It's the application-specific design you love with an all-new rugged construction to give you years of flawless measurements.

### Features

- **Large LCD**
  - A multilevel display provides at-a-glance readings of your most important numbers from any angle.
- **User-friendly Design**
  - With only two buttons, meter operation could not be simpler. Two buttons allow you to quickly adjust settings, select the measurement range, and choose calibration buffer sets.
- **Application Specific Probe**
  - Your measurements require detailed attention; so should your electrodes. Your probe has been carefully designed to meet the demands of your industry from body materials to junction type. Get top performance with a meter made for you.
- **Probe Condition**
  - An on-screen indicator provides visual confirmation that your probe is working at its best.
- **Durable IP67 waterproof casing**
  - Designed to withstand the knocks, drops, and spills of real life, the new IP67 body ensures top performance in any environment. These meters are protected against dust and water intrusion from any direction.



- **Watertight Connection**
  - A Quick Connect DIN connector makes attaching and removing the probe simple and easy. The rubber coating protects the cable and creates a sealed connection for added reliability.



- **HOLD button**
  - Freezes the reading on the display



- **Selectable temperature unit (°C or °F)**



- **Battery life indication, low battery detection and Auto-off function**
- **Automatic pH calibration at one or two points within two memorized buffer sets (standard or NIST)**
- **On-screen calibration tags**
- **Electrode condition indicator**
- **mV of pH measurement for electrode check**







Shown with: **HI710028**  
Silicon rubber boot, orange

Shown with: **HI710029**  
Silicon rubber boot, blue

- |   |  |  |
|---|--|--|
| <b>1</b> Three level display                          | <b>5</b> Selectable temperature unit, °C or °F | <b>9</b> HOLD button to freeze readings on the display |
| <b>2</b> Two level display                            | <b>6</b> electrode condition indicator         | <b>10</b> Quick Connect DIN connector                  |
| <b>3</b> Calibration tags                             | <b>7</b> Stability indicator                   | <b>11</b> HI710028 Silicon rubber boot, orange         |
| <b>4</b> Automatic temperature compensation indicator | <b>8</b> Power and MODE button                 | <b>12</b> HI710029 Silicon rubber boot, blue           |

HI991001 · HI991003

## pH/pH-mV/ORP and Temperature Meters

- Simultaneous pH, ORP, and temperature measurements on a large three-line LCD display (HI991003)
- Simultaneous pH and temperature measurements on a large dual-line LCD display (HI991001)
- User-friendly two button design
- Application specific probe
- Durable IP67 waterproof casing
- Watertight probe connection
- Probe condition indicator
- Automatic pH calibration at one or two points within two memorized buffer sets (standard or NIST)
- On-screen calibration tags
- mV measurement for electrode check
- Selectable temperature unit (°C or °F)
- Auto-off function
- Battery life indication and low battery detection

The HI991003 is a light weight, portable pH/ORP/temperature meter for pH and ORP measurements encountered in recreational waters (swimming pools and spas), plating baths, water treatment, manufacturing, and environmental testing applications. The meter is supplied with the HI12973 rugged probe protected with a titanium body specially designed for use on this meter.

HI991001 is a durable, portable, pH and temperature meter used for most pH measurements encountered in manufacturing and environmental testing protocols. The meter is provided with the HI12963 rugged titanium bodied electrode with built-in temperature sensor for temperature compensated pH and temperature readings.

- **Optional shockproof silicon rubber boot**
- Specially designed to protect your instrument from damage or impact

**HI710028** Orange  
**HI710029** Blue  
**HI710030** Green



Specifications	HI991001	HI991003	
pH	Range*	-2.00 to 16.00 pH / -2.0 to 16.0 pH	
	Resolution	0.01 pH / 0.1 pH	
	Accuracy (@25°C/77°F)	±0.02 pH / ±0.1 pH	
	Calibration	Automatic, one or two-point selectable bufferset standard: 4.01; 7.01; 10.01 or NIST: 4.01; 6.86; 9.18	
ORP	Range*	– ±1999 mV	
	Resolution	– 1 mV	
	Accuracy (@25°C/77°F)	– ±2 mV	
pH-mV	Range*	±825 mV ±825 mV	
	Resolution	1 mV 1 mV	
	Accuracy (@25°C/77°F)	±1 mV ±1 mV	
Temperature	Range*	-5.0 to 105.0°C/23.0 to 221.0°F	
	Resolution	0.1°C/0.1°F	
	Accuracy (@25°C/77°F)	±0.5°C up to 60°C; ±1.0°C outside; ±1.0°F up to 140°F; ±2.0°F outside	
Additional Specifications	Temperature Compensation	automatic, from -5.0 to 105.0°C (23.0 to 221.0°F)	
	Probe (included)	HI12963 preamplified pH and temperature probe with titanium body, DIN connector and 1 m (3.3') cable	HI12973 preamplified pH/ORP with internal temperature sensor, DIN connector and 1 m (3.3') cable
	Battery type / life	1.5V AAA (3) approx. 1400 hours of continuous use	
	Auto-Off	user selectable: after 8 min, 60 min, or disabled	
	Environment	0 to 50°C (32 to 122°F); RH max. 100%	
	Meter Dimensions	154 x 63 x 30 mm (6.1 x 2.5 x 1.2")	
	Meter Mass (with batteries)	196 g (6.91 oz.)	
	Case Ingress Protection Rating	IP67	
	Ordering Information	<p><b>HI991001</b> is supplied with HI12963 pH/temperature probe with titanium body and Quick Connect DIN connector with 1m (3.3') cable, pH 4.01 and 7.01 Buffer sachets, HI700601 electrode cleaning solution sachet (2), 100 mL beaker, 1.5V AAA batteries (3), calibration certificate of meter, calibration certificate of probe, instruction manual, and rugged carrying case.</p> <p><b>HI991003</b> is supplied with HI12973 pH/ORP/temperature probe with titanium body and Quick Connect DIN connector with 1m (3.3') cable, pH 4.01 and 7.01 Buffer sachets, HI700601 electrode cleaning solution sachet (2), 100 mL beaker, 1.5V AAA batteries (3), calibration certificate of meter, calibration certificate of probe, instruction manual, and HI710142 rugged carrying case.</p>	

\* HI12963 and HI12973 is limited to be used from 0 to 13 pH and from 0 to 80 °C temperature (32 to 176 °F).

HI99121

## Direct Soil pH Meter

with Measurement Kit

- Simultaneous pH and temperature measurements on a large dual-line LCD display
- User-friendly two button design
- Application specific probe
- Durable IP67 waterproof casing
- Watertight probe connection
- Probe condition indicator
- Automatic pH calibration at one or two points within two memorized buffer sets (standard or NIST)
- On-screen calibration tags
- mV measurement for electrode check
- Selectable temperature unit (°C or °F)
- Auto-off function
- Battery life indication and low battery detection
- Soil preparation solution
  - For higher degrees of accuracy, or for stony ground where the electrode may be damaged, use the included HI7051M soil preparation solution



### Specifications

HI99121

pH	Range*	-2.00 to 16.00 pH / -2.0 to 16.0 pH
	Resolution	0.01 pH / 0.1 pH
	Accuracy (@25°C/77°F)	±0.02 pH / ±0.1 pH
	Calibration	Automatic, one or two-point selectable bufferset standard: 4.01; 7.01; 10.01 or NIST: 4.01; 6.86; 9.18
pH-mV	Range*	±825 mV
	Resolution	1 mV
	Accuracy (@25°C/77°F)	±1 mV
Temperature	Range*	-5.0 to 105.0°C; 23.0 to 221.0°F
	Resolution	0.1°C; 0.1°F
	Accuracy(@25°C/77°F)	±0.5°C (up to 60°C), ±1.0°C (outside); ±1.0°F (up to 140°F), ±2.0°F (outside)
Additional Specifications	Temperature Compensation	automatic, from -5.0 to 105.0°C (23.0 to 221.0°F)
	Probe (included)	HI12923 glass body, pre-amplified pH electrode for soil measurement with internal temperature sensor, DIN connector and 1 m (3.3') cable
	Battery Type / Life	1.5V AAA (3) approx. 1400 hours of continuous use
	Auto-off	user selectable: after 8 min, 60 min, or disabled
	Environment	0 to 50°C (32 to 122°F); RH max. 100%
	Meter Dimensions	154 x 63 x 30 mm (6.1 x 2.5 x 1.2")
	Meter Mass (with batteries)	196 g (6.91 oz.)
	Case Ingress Protection Rating	IP67
Ordering Information	<p><b>HI99121</b> is supplied with HI12923 pH/temperature probe with glass body and Quick Connect DIN connector with 1m (3.3') cable, pH 4.01 and 7.01 Buffer sachets, HI700663 electrode cleaning solution sachet for soil deposits, HI700664 electrode cleaning solution sachet for humus deposits, HI7051M soil preparation solution, HI721319 ground auger, 100 mL beaker, 1.5V AAA batteries (3), calibration certificate of meter, calibration certificate of probe, instruction manual and HI710142 rugged carrying case.</p>	

The HI99121 is the perfect portable pH meter for soil testing. With the HI99121 and HI12923 direct soil pre-amplified pH and temperature probe, users can test both the pH of soil directly or after preparation of a soil slurry with deionized water.

The HI12923 features a conical, rugged tip that can be directly used in soil. A plastic auger is supplied to perforate and loosen the soil prior to sensor measurement. Use this tool to prevent scratching the pH sensitive glass on nutrient crystals or small pebbles.



- Optional shockproof silicon rubber boot
  - Specially designed to protect your instrument from damage or impact

**HI710028** Orange  
**HI710029** Blue  
**HI710030** Green

\* the HI12923 is limited to be used from 0-12 pH and from -5 to 70 °C temperature (23 to 158°F).

HI99131

## Portable pH Meter

for Plating Baths

- Simultaneous pH and temperature measurements on a large dual-line LCD display
- User-friendly two button design
- Application specific probe
- Durable IP67 waterproof casing
- Watertight probe connection
- Probe condition indicator
- Automatic pH calibration at one or two points within two memorized buffer sets (standard or NIST)
- On-screen calibration tags
- mV measurement for electrode check
- Selectable temperature unit (°C or °F)
- Auto-off function
- Battery life indication and low battery detection

Plating Baths can vary from acid to neutral to alkaline with many different chemical formulations used. The common necessity is the fast and accurate measurement of pH to ensure that additives and chemicals are working properly to provide even and consistent plating.

The HI99131 portable pH meter and HI629113 pH electrode are specially designed for pH measurements in plating baths.

The titanium electrode body acts like a Faraday cage, and allows stable readings even in samples where strong electrical fields are involved.

Moreover, a built-in temperature sensor allows simultaneous temperature compensated pH and temperature readings and a pH sensor preamplifier provides measurements impervious to noise and electrical interferences.

- Optional shockproof silicon rubber boot
- Specially designed to protect your instrument from damage or impact

**HI710028** Orange  
**HI710029** Blue  
**HI710030** Green



### Specifications

### HI99131

pH	Range*	-2.00 to 16.00 pH / -2.0 to 16.0 pH
	Resolution	0.01 pH / 0.1 pH
	Accuracy (@25°C/77°F)	±0.02 pH / ±0.1 pH
	Calibration	Automatic, one or two-point selectable bufferset standard: 4.01; 7.01; 10.01 or NIST: 4.01; 6.86; 9.18
pH-mV	Range*	±825 mV
	Resolution	1 mV
	Accuracy (@25°C/77°F)	±1 mV
Temperature	Range*	-5.0 to 105.0°C; 23.0 to 221.0°F
	Resolution	0.1°C; 0.1°F
	Accuracy (@25°C/77°F)	±0.5°C (up to 60°C), ±1.0°C (outside); ±1.0°F (up to 140°F), ±2.0°F (outside)
Additional Specifications	Temperature Compensation	automatic, from -5.0 to 105.0°C (23.0 to 221.0°F)
	Probe (included)	HI629113 preamplified pH probe with built-in temperature sensor and titanium cage working as matching pin, DIN connector with 1m (3.3') cable
	Battery Type / Life	1.5V AAA (3) approx. 1400 hours of continuous use
	Auto-off	user selectable: after 8 min, 60 min, or disabled
	Environment	0 to 50°C (32 to 122°F); RH max. 100%
	Meter Dimensions	154 x 63 x 30 mm (6.1 x 2.5 x 1.2")
	Meter Mass (with batteries)	196 g (6.91 oz.)
Case Ingress Protection Rating	IP67	
Ordering Information	<b>HI99131</b> is supplied with HI629113 preamplified pH probe with built-in temperature sensor and titanium body, Quick Connect DIN connector with 1m (3.3') cable, pH 4.01 and 7.01 Buffer sachets, HI700601 electrode cleaning solution sachets (2), 100 mL beaker, 1.5V AAA batteries (3), calibration certificate of meter, calibration certificate of probe, instruction manual, and HI710142 rugged carrying case.	

\* the HI629113 is limited to be used from 0 to 13 pH and from 0 to 80 °C temperature (32 to 176 °F).



HI99141

## Portable pH Meter

for Boiler and Cooling Towers

- Simultaneous pH and temperature measurements on a large dual-line LCD display
- User-friendly two button design
- Application specific probe
- Durable IP67 waterproof casing
- Watertight probe connection
- Probe condition indicator
- Automatic pH calibration at one or two points within two memorized buffer sets (standard or NIST)
- On-screen calibration tags
- mV measurement for electrode check
- Selectable temperature unit (°C or °F)
- Auto-off function
- Battery life indication and low battery detection

The HI99141 pH meter is a portable, lightweight meter with two button operation that is simple to use. It is delivered with a rugged pH electrode protected by a titanium body that is perfect for the pH measurement of treated boiler, feed water, and steam condensate.

HI729113 is a rugged double junction pH electrode with a flat pH sensor and titanium body. The electrode has a peripheral Teflon® junction for maximum surface contact and flat pH tip is easy to clean and prevents solids from collecting on the sensor. Chemicals used to minimize scale, corrosion and foaming require an optimum pH. Measuring and controlling water quality helps minimize these effects.

A built-in temperature sensor allows simultaneous temperature compensated pH and temperature readings and a built-in pH sensor preamplifier provides measurements impervious to noise and electrical interferences.

- Optional shockproof silicon rubber boot
- Specially designed to protect your instrument from damage or impact

HI710028 Orange  
HI710029 Blue  
HI710030 Green



### Specifications

HI99141

pH	Range*	-2.00 to 16.00 pH / -2.0 to 16.0 pH
	Resolution	0.01 pH / 0.1 pH
	Accuracy (@25°C/77°F)	±0.02 pH / ±0.1 pH
	Calibration	Automatic, one or two-point selectable bufferset standard: 4.01; 7.01; 10.01 or NIST: 4.01; 6.86; 9.18
pH-mV	Range*	±825 mV
	Resolution	1 mV
	Accuracy (@25°C/77°F)	±1 mV
Temperature	Range*	-5.0 to 105.0°C; 23.0 to 221.0°F
	Resolution	0.1°C; 0.1°F
	Accuracy (@25°C/77°F)	±0.5°C (up to 60°C), ±1.0°C (outside); ±1.0°F (up to 140°F), ±2.0°F (outside)
Additional Specifications	Temperature Compensation	automatic, from -5.0 to 105.0°C (23.0 to 221.0°F)
	Probe (included)	HI729113 preamplified pH probe with built-in temperature sensor and titanium cage working as matching pin, DIN connector with 1m (3.3') cable
	Battery Type / Life	1.5V AAA (3) approx. 1400 hours of continuous use
	Auto-off	user selectable: after 8 min, 60 min or disabled
	Environment	0 to 50°C (32 to 122°F); RH max. 100%
	Meter Dimensions	154 x 63 x 30 mm (6.1 x 2.5 x 1.2")
	Meter Mass (with batteries)	196 g (6.91 oz.)
	Case Ingress Protection Rating	IP67
Ordering Information	<p><b>HI99141</b> is supplied with HI729113 preamplified pH probe with built-in temperature sensor and matching pin, Quick Connect DIN connector with 1m (3.3') cable, pH 4.01 and 7.01 buffer sachets, HI700601 electrode cleaning solution sachets (2), 100 mL beaker, 1.5V AAA batteries (3), calibration certificate of meter, calibration certificate of probe, instruction manual, and HI710142 rugged carrying case.</p>	

\* the HI729113 is limited to be used from 0 to 13 pH and from 0 to 80°C temperature (32 to 176°F).

# Portable pH Meter

for Leather and Paper

- Simultaneous pH and temperature measurements on a large dual-line LCD display
- User-friendly two button design
- Application specific probe
- Durable IP67 waterproof casing
- Watertight probe connection
- Probe condition indicator
- Automatic pH calibration at one or two points within two memorized buffer sets (standard or NIST)
- On-screen calibration tags
- mV measurement for electrode check
- Selectable temperature unit (°C or °F)
- Auto-off function
- Battery life indication and low battery detection



HI99171 is a light weight, portable pH meter supplied with a specially designed pH electrode intended for the direct determination of pH on flat surfaces, such as leather or paper.

The HI99171 portable pH meter together with a HI14143 combination pH electrode (when immersed in a drop of water on the surface of the sample), can determine the pH of the surface with high accuracy and repeatability without the requirement of sample destruction.

During production of cartons and paper used for food packaging, pH measurements provide a useful gauge of product compatibility. pH of a paper is usually considered one of the most reliable indices of the permanence of a paper. Conservators of historical documents (some of which are very valuable or irreplaceable) require a convenient non-destructive method to determine pH.

Leather technicians rely on a pH determination to optimize dyes, coating, and softening agents in order to preserve the fiber structure and prevent damage to leather. Leather is acidic. Its pH is measured at between 4.5 and 5.0. Surface pH measurements provide a non-destructive means to meet specifications and optimize product quality.

## Specifications

## HI99171

pH	Range*	-2.00 to 16.00 pH / -2.0 to 16.0 pH	
	Resolution	0.01 pH / 0.1 pH	
	Accuracy (@25°C/77°F)	±0.02 pH / ±0.1 pH	
	Calibration	Automatic, one or two-point selectable bufferset standard: 4.01; 7.01; 10.01 or NIST: 4.01; 6.86; 9.18	
pH-mV	Range*	±825 mV	
	Resolution	1 mV	
	Accuracy (@25°C/77°F)	±1 mV	
Temperature	Range*	-5.0 to 105.0°C; 23.0 to 221.0°F	
	Resolution	0.1°C; 0.1°F	
	Accuracy (@25°C/77°F)	±0.5°C (up to 60°C), ±1.0°C (outside); ±1.0°F (up to 140°F), ±2.0°F (outside)	
Additional Specifications	Temperature Compensation	automatic, from -5.0 to 105.0°C (23.0 to 221.0°F)	
	Probe (included)	HI14143 preamplified pH and temperature probe with flat tip, DIN connector, and 1 m (3.3') cable	
	Battery Type / Life	1.5V AAA (3) approx. 1400 hours of continuous use	
	Auto-off	user selectable: after 8 min, 60 min, or disabled	
	Environment	0 to 50°C (32 to 122°F); RH max. 100%	
	Meter Dimensions	154 x 63 x 30 mm (6.1 x 2.5 x 1.2")	
	Meter Mass (with batteries)	196 g (6.91 oz.)	
	Case Ingress Protection Rating	IP67	
	Ordering Information	<p><b>HI99171</b> is supplied with HI14143 pH/temperature probe with flat tip and Quick Connect DIN connector with 1m (3.3') cable, pH 4.01 and 7.01 buffer sachets, HI700680 cleaning solution for ink stains sachets (2), HI70960 conductive electrolyte solution for pH measurement (30 mL), 100 mL beaker, 1.5V AAA batteries (3), calibration certificate of meter, calibration certificate of probe, instruction manual, and HI710142 rugged carrying case.</p>	

\* the HI14143 is limited to be used from 0 to 12 pH and from 0 to 50 °C temperature (32 to 122 °F).

## Foodcare

HI99162

### pH / Temperature Meter for Milk

with Application Specific Probe

- Simultaneous pH and temperature measurements on a large dual-line LCD display
- User-friendly two button design
- Application specific probe
- Durable IP67 waterproof casing
- Watertight probe connection
- Probe condition indicator
- Automatic pH calibration at one or two points within two memorized buffer sets (standard or NIST)
- On-screen calibration tags
- mV measurement for electrode check
- Selectable temperature unit (°C or °F)
- Auto-off function
- Battery life indication and low battery detection



#### Specifications

HI99162

pH	Range*	-2.00 to 16.00 pH / -2.0 to 16.0 pH
	Resolution	0.01 pH / 0.1 pH
	Accuracy (@25°C/77°F)	±0.02 pH / ±0.1 pH
pH-mV	Range*	±825 mV
	Resolution	1 mV
	Accuracy (@25°C/77°F)	±1 mV
Temperature	Range*	-5.0 to 105.0°C; 23.0 to 221.0°F
	Resolution	0.1°C; 0.1°F
	Accuracy (@25°C/77°F)	±0.5°C (up to 60°C), ±1.0°C (outside); ±1.0°F (up to 140°F), ±2.0°F (outside)
Additional Specifications	Temperature Compensation	automatic, from -5.0 to 105.0°C (23.0 to 221.0°F)
	Probe (included)	FC1013 preamplified pH and temperature probe, DIN connector and 1 m (3.3') cable
	Battery Type / Life	1.5V AAA (3) approx. 1400 hours of continuous use
	Auto-off	user selectable: after 8 min, 60 min or disabled
	Environment	0 to 50°C (32 to 122°F); RH max. 100%
	Meter Dimensions	154 x 63 x 30 mm (6.1 x 2.5 x 1.2")
	Meter Mass (with batteries)	196 g (6.91 oz.)
	Case Ingress Protection Rating	IP67
Ordering Information	<b>HI99162</b> is supplied with FC1013 preamplified pH/temperature probe with Quick Connect DIN connector and 1 m (3.3') cable, pH 4.01 and 7.01 buffer sachets, HI700640 electrode cleaning solution sachet for milk deposits (2), 100 mL beaker, 1.5V AAA batteries (3), calibration certificate of meter, calibration certificate of probe, instruction manual, and HI710142 rugged carrying case.	

\* the FC1013 is limited to be used from 0 to 13 pH and from 0 to 80 °C temperature (32 to 176 °F).

HI99162 is a portable pH and temperature meter designed specifically for pH measurement in milk. The measurement of pH in milk is important in testing for impurities, spoilage, and signs of infection. Fresh milk has a pH value close to pH 6.7. When the pH value of milk falls below pH 6.7, it typically indicates spoilage by bacterial degradation. Milk with pH values higher than pH 6.7 potentially indicate that milk may have come from cows with a mastitis infection.

The FC1013 pH electrode has a built-in temperature sensor for simultaneous temperature compensated pH and temperature readings, and also contains a pH sensor preamplifier to provide measurements impervious to noise and electrical interferences.

FC1013 electrode has a PVDF body, double junction reference with refillable bridge electrolyte and ceramic junction.

The HI99162 and FC1013 provide measurements where your milk is processed to optimize operations.

pH

portable

## Foodcare

HI99164

### pH / Temperature Meter for Yogurt

with Application Specific Probe

- Simultaneous pH and temperature measurements on a large dual-line LCD display
- User-friendly two button design
- Application specific probe
- Durable IP67 waterproof casing
- Watertight probe connection
- Probe condition indicator
- Automatic pH calibration at one or two points within two memorized buffer sets (standard or NIST)
- On-screen calibration tags
- mV measurement for electrode check
- Selectable temperature unit (°C or °F)
- Auto-off function
- Battery life indication and low battery detection

HI99164 is a portable pH and temperature meter designed specifically for pH measurement in yogurt.

Monitoring pH is crucial in producing consistent, quality yogurt. Yogurt is made by fermentation of milk with live bacterial cultures. Once milk is pasteurized, live culture is added and the mixture of milk and bacteria is incubated. Yogurt producers cease incubation once a specific pH level is reached. By verifying that fermentation continues to a predetermined pH endpoint, yogurt producers can ensure their products remain consistent in terms of flavor, aroma, and texture.

The FC2133 pH electrode is rugged and easy to clean with a conical tip and built-in temperature sensor. The open junction design consists of a solid gel interface (viscolene) between the sample and internal Ag/AgCl reference. This interface not only prevents silver from entering the sample, but also makes it impermeable to clogging after measurements in semi-solid or viscous samples. FC2133 electrode is designed to prevent the typical problems of clogging in viscous liquids, ensuring a fast response and stable reading.



- Optional shockproof silicon rubber boot
- Specially designed to protect your instrument from damage or impact

HI710028 Orange  
HI710029 Blue  
HI710030 Green

#### Specifications

HI99164

pH	Range*	-2.00 to 16.00 pH / -2.0 to 16.0 pH
	Resolution	0.01 pH / 0.1 pH
	Accuracy (@25°C/77°F)	±0.02 pH / ±0.1 pH
	Calibration	Automatic, one or two-point selectable bufferset standard: 4.01; 7.01; 10.01 or NIST: 4.01; 6.86; 9.18
pH-mV	Range*	±825 mV
	Resolution	1 mV
	Accuracy (@25°C/77°F)	±1 mV
Temperature	Range*	-5.0 to 105.0°C; 23.0 to 221.0°F
	Resolution	0.1°C; 0.1°F
	Accuracy (@25°C/77°F)	±0.5°C (up to 60°C), ±1.0°C (outside); ±1.0°F (up to 140°F), ±2.0°F (outside)
Additional Specifications	Temperature Compensation	automatic, from -5.0 to 105.0°C (23.0 to 221.0°F)
	Probe (included)	FC2133 preamplified pH and temperature probe, DIN connector, and 1 m (3.3') cable
	Battery Type / Life	1.5V AAA (3) approx. 1400 hours of continuous use
	Auto-off	user selectable: after 8 min, 60 min, or disabled
	Environment	0 to 50°C (32 to 122°F); RH max. 100%
	Meter Dimensions	154 x 63 x 30 mm (6.1 x 2.5 x 1.2")
	Meter Mass (with batteries)	196 g (6.91 oz.)
	Case Ingress Protection Rating	IP67
Ordering Information	<p><b>HI99164</b> is supplied with FC2133 pH/temperature probe and Quick Connect DIN connector with 1m (3.3') cable, pH 4.01 and 7.01 buffer sachets, HI700643 cleaning solution sachets for yogurt deposits (2), 100 mL beaker, 1.5V AAA batteries (3), calibration certificate of meter, calibration certificate of probe, instruction manual, and HI710142 rugged carrying case.</p>	

\* the FC2133 is limited to be used from 0 to 12 pH and from 0 to 50°C temperature (32 to 122°F).



## Foodcare

HI99165

# pH / Temperature Meter for Cheese

with Application Specific Probe

- Simultaneous pH and temperature measurements on a large dual-line LCD display
- User-friendly two button design
- Application specific probe
- Durable IP67 waterproof casing
- Watertight probe connection
- Probe condition indicator
- Automatic pH calibration at one or two points within two memorized buffer sets (standard or NIST)
- On-screen calibration tags
- mV measurement for electrode check
- Selectable temperature unit (°C or °F)
- Auto-off function
- Battery life indication and low battery detection



### Specifications

HI99165

pH	Range*	-2.00 to 16.00 pH / -2.0 to 16.0 pH
	Resolution	0.01 pH / 0.1 pH
	Accuracy (@25°C/77°F)	±0.02 pH / ±0.1 pH
	Calibration	Automatic, one or two-point selectable bufferset standard: 4.01; 7.01; 10.01 or NIST: 4.01; 6.86; 9.18
pH-mV	Range*	±825 mV
	Resolution	1 mV
	Accuracy (@25°C/77°F)	±1 mV
Temperature	Range*	-5.0 to 105.0°C; 23.0 to 221.0°F
	Resolution	0.1°C; 0.1°F
	Accuracy (@25°C/77°F)	±0.5°C (up to 60°C), ±1.0°C (outside); ±1.0°F (up to 140°F), ±2.0°F (outside)
Additional Specifications	Temperature Compensation	automatic, from -5.0 to 105.0°C (23.0 to 221.0°F)
	Probe (included)	FC2423 preamplified pH and temperature probe, DIN connector, and 1 m (3.3') cable
	Battery Type / Life	1.5V AAA (3) approx. 1400 hours of continuous use
	Auto-off	user selectable: after 8 min, 60 min, or disabled
	Environment	0 to 50°C (32 to 122°F); RH max. 100%
	Meter Dimensions	154 x 63 x 30 mm (6.1 x 2.5 x 1.2")
	Meter Mass (with batteries)	196 g (6.91 oz.)
	Case Ingress Protection Rating	IP67
Ordering Information	<p><b>HI99165</b> is supplied with FC2423 preamplified pH/temperature probe with Quick Connect DIN connector and 1 m (3.3') cable, pH 4.01 and 7.01 buffer sachets, HI700642 cleaning solution for cheese deposits (2), 100 mL beaker, 1.5V AAA batteries (3), calibration certificate of meter, calibration certificate of probe, instruction manual, and HI710142 rugged carrying case.</p>	

\* the FC2423 is limited to be used from 0 to 12 pH and from 0 to 50°C temperature (32 to 122°F).

Throughout the cheese making process, pH measurement is perhaps the most important cheese making management tool. It is an essential parameter in achieving the desired characteristics, quality, and shelf-life of the finished product.

The HI99165 is a waterproof portable pH and temperature meter designed for pH measurement in cheese.

The FC2423 is a penetration style pH electrode with a conical sensing tip and features an easy to clean, stainless steel sheath and single junction gel filled reference with a free diffusion sleeve style reference junction. The electrode is designed for penetration into solids and emulsions for direct measurement of pH in cheese products.

- Optional shockproof silicon rubber boot
- Specially designed to protect your instrument from damage or impact

HI710028 Orange  
HI710029 Blue  
HI710030 Green



## Foodcare

HI99161

### Portable pH Meter

for yogurt, cheese, and semi-solids

- Simultaneous pH and temperature measurements on a large dual-line LCD display
- User-friendly two button design
- Application specific probe
- Durable IP67 waterproof casing
- Watertight probe connection
- Probe condition indicator
- Automatic pH calibration at one or two points within two memorized buffer sets (standard or NIST)
- On-screen calibration tags
- mV measurement for electrode check
- Selectable temperature unit (°C or °F)
- Auto-off function
- Battery life indication and low battery detection



The HI99161 is a portable, lightweight meter with two button operation that is simple to use. It is designed specifically for use in yogurt, cheese, and semi-solids.

The meter is supplied with the FC2023 pH electrode specially designed for use in the food sector.

The FC2023 is a penetration style pH electrode with a conical sensing tip and features an easy to clean, PVDF body and double junction gel filled reference with a free diffusion sleeve style reference junction. The electrode is ideal for measurements in semisolid foods such as processed meats, soft cheeses, soups, sauces, condiments, jams, jellies, dough, ice cream and sushi rice.



- **Optional shockproof silicon rubber boot**
- Specially designed to protect your instrument from damage or impact

HI710028 Orange  
HI710029 Blue  
HI710030 Green

#### Specifications

#### HI99161

pH	Range*	-2.00 to 16.00 pH / -2.0 to 16.0 pH
	Resolution	0.01 pH / 0.1 pH
	Accuracy (@25°C/77°F)	±0.02 pH / ±0.1 pH
pH-mV	Range*	±825 mV
	Resolution	1 mV
	Accuracy (@25°C/77°F)	±1 mV
Temperature	Range*	-5.0 to 105.0°C; 23.0 to 221.0°F
	Resolution	0.1°C; 0.1°F
	Accuracy (@25°C/77°F)	±0.5°C (up to 60°C), ±1.0°C (outside); ±1.0°F (up to 140°F), ±2.0°F (outside)
Additional Specifications	Temperature Compensation	automatic, from -5.0 to 105.0°C (23.0 to 221.0°F)
	Probe (included)	FC2023 preamplified pH/temperature probe with DIN connector, and 1 m (3.3') cable
	Battery Type / Life	1.5V AAA (3) approx. 1400 hours of continuous use
	Auto-off	user selectable: after 8 min, 60 min, or disabled
	Environment	0 to 50°C (32 to 122°F); RH max. 100%
	Meter Dimensions	154 x 63 x 30 mm (6.1 x 2.5 x 1.2")
	Meter Mass (with batteries)	196 g (6.91 oz.)
Case Ingress Protection Rating	IP67	
Ordering Information	<p><b>HI99161</b> is supplied with FC2023 preamplified pH/temperature probe with conical tip, Quick Connect DIN connector and 1 m (3.3') cable, pH 4.01 and 7.01 buffer sachets, HI700601 electrode cleaning solution sachets (2), 100 mL beaker, 1.5V AAA batteries (3), calibration certificate of meter, calibration certificate of probe, instruction manual, and HI710142 rugged carrying case.</p>	

\* the FC2023 is limited to be used from 0 to 12 pH and from 0 to 50°C temperature (32 to 122°F).

HI99163

## Portable pH Meter

and Sensor for Meat

- Simultaneous pH and temperature measurements on a large dual-line LCD display
- User-friendly two button design
- Application specific probe
- Durable IP67 waterproof casing
- Watertight probe connection
- Probe condition indicator
- Automatic pH calibration at one or two points within two memorized buffer sets (standard or NIST)
- On-screen calibration tags
- mV measurement for electrode check
- Selectable temperature unit (°C or °F)
- Auto-off function
- Battery life indication and low battery detection



### Specifications

HI99163

pH	Range*	-2.00 to 16.00 pH / -2.0 to 16.0 pH
	Resolution	0.01 pH / 0.1 pH
	Accuracy (@25°C/77°F)	±0.02 pH / ±0.1 pH
	Calibration	Automatic, one or two-point selectable bufferset standard: 4.01; 7.01; 10.01 or NIST: 4.01; 6.86; 9.18
pH-mV	Range*	±825 mV
	Resolution	1 mV
	Accuracy (@25°C/77°F)	±1 mV
Temperature	Range*	-5.0 to 105.0°C; 23.0 to 221.0°F
	Resolution	0.1°C; 0.1°F
	Accuracy (@25°C/77°F)	±0.5°C (up to 60°C), ±1.0°C (outside); ±1.0°F (up to 140°F), ±2.0°F (outside)
Additional Specifications	Temperature Compensation	automatic, from -5.0 to 105.0°C (23.0 to 221.0°F)
	Probe (included)	FC2323 amplified pH/temperature probe with stainless steel blade, DIN connector, and 1 m (3.3') cable
	Battery Type / Life	1.5V AAA (3) approx. 1400 hours of continuous use
	Auto-off	user selectable: after 8 min, 60 min, or disabled
	Environment	0 to 50°C (32 to 122°F); RH max. 100%
	Meter Dimensions	154 x 63 x 30 mm (6.1 x 2.5 x 1.2")
	Meter Mass (with batteries)	196 g (6.91 oz.)
	Case Ingress Protection Rating	IP67

### Ordering Information

**HI99163** is supplied with FC2323 amplified pH/temperature probe with stainless steel blade, Quick Connect DIN connector and 1 m (3.3') cable, pH 4.01 and 7.01 buffer sachets, HI700630 grease and fats acid cleaning solution sachets (2), 100 mL beaker, 1.5V AAA batteries (3), calibration certificate of meter, calibration certificate of probe, instruction manual, and HI710142 rugged carrying case.

A reliable pH measurement is an important factor in meat processing. pH affects many quality factors including color, grading, tenderness, texture, and process characteristics. A direct measurement of muscle pH, deep in the muscle is the best way to determine pH.

HI99163 is a portable pH and temperature meter with a special probe, dedicated to the measurement of pH in meat processing. The meter works at cold store operating temperatures to 0°C (32°F).

The FC2323 probe has been specially designed for meat processing and comes with a removable stainless steel lance for meat/muscle penetration. The FC2323 is a penetration style pH electrode with a conical sensing tip and features an easy to clean, PVDF body and single junction gel filled reference with a free diffusion sleeve style reference junction.

A pH sensor preamplifier provides measurements impervious to noise and electrical interferences often experienced at cold temperatures with conventional pH equipment.

\* the FC2323 is limited to be used from 0 to 12 pH and from 0 to 50°C temperature (32 to 122°F).

# Foodcare

HI99192

## Portable pH Meter

for Drinking Water

- Simultaneous pH and temperature measurements on a large dual-line LCD display
- User-friendly two button design
- Application specific probe
- Durable IP67 waterproof casing
- Watertight probe connection
- Probe condition indicator
- Automatic pH calibration at one or two points within two memorized buffer sets (standard or NIST)
- On-screen calibration tags
- mV measurement for electrode check
- Selectable temperature unit (°C or °F)
- Auto-off function
- Battery life indication and low battery detection



- Optional shockproof silicon rubber boot
- Specially designed to protect your instrument from damage or impact

HI710028 Orange  
 HI710029 Blue  
 HI710030 Green

HI99192 is a portable, lightweight pH meter that is supplied with a FC2153 pH electrode designed specifically for measuring the pH of potable waters.

The pair are ideal for on-site spot checks of drinking water. The pH of potable water is fundamental to ensure safe water quality. If the pH is too low, drinking water will be corrosive to the distribution system and water pipes in homes. If it is too high, it can reduce the effectiveness of disinfectants. The pH of water also influences aesthetic or cosmetic properties including taste, odor, and clarity. Most public water operations maintain pH between 6.5 and 8.5.

The HI99192 together with the FC2153 pH electrode solves all the problems found with standard pH systems. This specialized electrode offers numerous features that improve pH testing in drinking water. The spherical pH bulb features a low resistance pH glass that responds quickly to the sample (even at cold temperatures). It also has a refillable single junction Ag/AgCl reference that is used with a KCl electrolyte and has three ceramic junctions to ensure continuity and provide quick and reproducible measurements (even in low ionic strength waters).

### Specifications

### HI99192

pH	Range*	-2.00 to 16.00 pH / -2.0 to 16.0 pH
	Resolution	0.01 pH / 0.1 pH
	Accuracy (@25°C/77°F)	±0.02 pH / ±0.1 pH
pH-mV	Range*	±825 mV
	Resolution	1 mV
	Accuracy (@25°C/77°F)	±1 mV
Temperature	Range*	-5.0 to 105.0°C; 23.0 to 221.0°F
	Resolution	0.1°C; 0.1°F
	Accuracy (@25°C/77°F)	±0.5°C (up to 60°C), ±1.0°C (outside); ±1.0°F (up to 140°F), ±2.0°F (outside)
Additional Specifications	Temperature Compensation	automatic, from -5.0 to 105.0°C (23.0 to 221.0°F)
	Probe (included)	FC2153 pH electrode with internal temperature sensor, with DIN connector, and 1 m (3.3') cable
	Battery Type / Life	1.5V AAA (3) approx. 1400 hours of continuous use
	Auto-off	user selectable: after 8 min, 60 min, or disabled
	Environment	0 to 50°C (32 to 122°F); RH max. 100%
	Meter Dimensions	154 x 63 x 30 mm (6.1 x 2.5 x 1.2")
	Meter Mass (with batteries)	196 g (6.91 oz.)
	Case Ingress Protection Rating	IP67
Ordering Information	<p><b>HI99192</b> is supplied with FC2153 pH electrode with internal temperature sensor, with Quick Connect DIN connector and 1 m (3.3') cable, pH 4.01 and 7.01 buffer sachets, HI700601 general electrode cleaning solution sachets (2), 100 mL beaker, 1.5V AAA batteries (3), calibration certificate of meter, calibration certificate of probe, instruction manual, and HI710142 rugged carrying case.</p>	

\* the FC2153 is limited to be used from 0 to 12 pH and from 0 to 70 °C temperature (32 to 158 °F).



## FC2153 Amplified pH Electrode

- Built-in temperature sensor
  - For automatic compensation of temperature variations
- Refillable pH electrode
- Amplified electrode
  - For fast, stable response that is immune to electrical noise due to humidity
- Triple ceramic junction design

The HI99192 drinking water pH meter uses the glass body FC2153 amplified pH electrode. The amplified electrode provides a fast stable response that is immune to electrical noise due to humidity. The electrode contains an internal temperature probe to allow for automatic compensation for any variances in temperature. The electrolyte solution in the electrode is refillable.

An integral part of any pH electrode is the reference junction. The reference junction allows for the flow of ions located in the reference cell into the sample being measured. The ions provide for an electrical connection between the reference electrode and the indicating electrode. A standard pH electrode will use a single ceramic junction that allows for 15 to 20  $\mu\text{L}/\text{hour}$  of electrolyte to flow. The FC2153 has three ceramic junctions providing for 40 to 50  $\mu\text{L}/\text{hour}$  of electrolyte to flow. This increased flow provides a greater continuity between the reference electrode and the indicating electrode, making it suitable for water with low ionic strength. To optimize the flow from the electrode, the refill cap should be unscrewed; this allows for positive head pressure to be created, allowing for the electrolyte to flow more easily into the sample.

### The pH of Drinking Water

The pH of drinking water is a vital measurement. If the pH is too low, or acidic, the water will be corrosive to the distribution system and water pipes in homes. The pH of water also influences other properties including taste, odor, clarity, and efficiency of disinfection. In the United States, the pH of water is determined by a pH meter according to EPA method 150.1 and Standard Methods 4500-H.

Most drinking water plants use surface water (lakes, rivers, and streams) or groundwater as their point source. Surface water is typically lower in mineral content, which results in lower EC/TDS readings. Groundwater that has percolated through limestone, dolomite, or gypsum will have a relatively higher mineral content. Depending on location, there are sources of groundwater that can be very low in mineral content.

Measuring the pH of water that is low in minerals can be difficult. The lower the mineral content the less conductive the water will be. Low conductivity water presents a challenge since the pH meter is an electrochemical system that relies on the solution being measured to be conductive. The HI99192 uses the FC2153 amplified pH electrode. The FC2153 has three ceramic junctions in the outer reference cell that allows for pH measurement in low conductivity solutions.

\* Limits will be reduced to actual sensor limits

## Foodcare

HI99151

# Portable pH Meter

for Beer Analysis

- Simultaneous pH and temperature measurements on a large dual-line LCD display
- User-friendly two button design
- Application specific probe
- Durable IP67 waterproof casing
- Watertight probe connection
- Probe condition indicator
- Automatic pH calibration at one or two points within two memorized buffer sets (standard or NIST)
- On-screen calibration tags
- mV measurement for electrode check
- Selectable temperature unit (°C or °F)
- Auto-off function
- Battery life indication and low battery detection



HI99151 is a portable, microprocessor-based pH and temperature meter specifically designed for beer brewing.

It is supplied with the FC2143 rugged double junction pH electrode with a flat pH sensor profile, cloth reference junction, and titanium body perfect for brewing operations.

There are no crevices to collect solids and the pH and temperature specifications are pertinent to most brewing operations.

Together, they are versatile tools for measuring the pH in brewing operations such as mashing and wort separations, measuring the pH of the cooled wort boil, checking the fermentation pH, and checking the finished or conditioned beer.



- Optional shockproof silicon rubber boot
  - Specially designed to protect your instrument from damage or impact

HI710028 Orange

HI710029 Blue

HI710030 Green

### Specifications

### HI99151

pH	Range*	-2.00 to 16.00 pH / -2.0 to 16.0 pH
	Resolution	0.01 pH / 0.1 pH
	Accuracy (@25°C/77°F)	±0.02 pH / ±0.1 pH
pH-mV	Range*	±825 mV
	Resolution	1 mV
	Accuracy (@25°C/77°F)	±1 mV
Temperature	Range*	-5.0 to 105.0°C; 23.0 to 221.0°F
	Resolution	0.1°C; 0.1°F
	Accuracy (@25°C/77°F)	±0.5°C (up to 60°C), ±1.0°C (outside); ±1.0°F (up to 140°F), ±2.0°F (outside)
Additional Specifications	Temperature Compensation	automatic, from -5.0 to 105.0°C (23.0 to 221.0°F)
	Probe (included)	FC2143 preamplified pH/temperature probe with DIN connector, and 1 m (3.3') cable, titanium body
	Battery Type / Life	1.5V AAA (3) approx. 1400 hours of continuous use
	Auto-off	user selectable: after 8 min, 60 min, or disabled
	Environment	0 to 50°C (32 to 122°F); RH max. 100%
	Meter Dimensions	154 x 63 x 30 mm (6.1 x 2.5 x 1.2")
	Meter Mass (with batteries)	196 g (6.91 oz.)
Case Ingress Protection Rating	IP67	
Ordering Information	<p><b>HI99151</b> is supplied with FC2143 preamplified pH/temperature probe with Quick Connect DIN connector and 1 m (3.3') cable, pH 4.01 and 7.01 buffer sachets, HI700682 electrode cleaning solution for brewing deposits sachets (2), 100 mL beaker, 1.5V AAA batteries (3), calibration certificate of meter, calibration certificate of probe, instruction manual, and HI710142 rugged carrying case.</p>	

\* the FC2143 is limited to be used from 0 to 12 pH and from 0 to 80°C temperature (32 to 176°F)

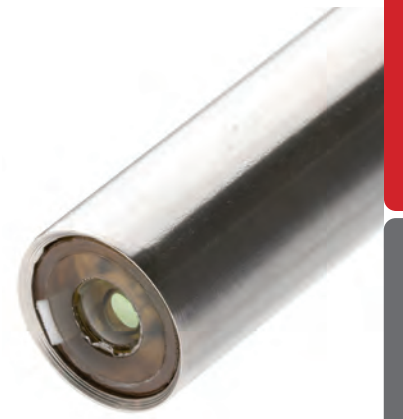

## FC2143 Amplified pH Electrode

- **Amplified electrode**
  - Provides a fast, stable response that is immune to electrical noise due to static discharge
- **Maintenance free gel filled electrode**
  - No fill solution required
- **Highly durable titanium body**
- **Low temperature glass**

The HI99151 beer pH meter uses the titanium bodied FC2143 amplified pH electrode with built-in temperature sensor. The amplified electrode provides a fast, stable response that is immune to electrical noise due to static discharge. The body of the electrode is made from titanium, which provides an unbreakable structure.

### The Effects of pH in Brewing

In the brewing process, the enzymes required to convert starch into sugar are pH-sensitive, with an optimal pH of 5.2 to 5.6. Different compounds are used to adjust the pH including phosphoric acid, lactic acid, and gypsum.

Wort clarity and break formation are also affected by pH. Protein coagulation occurs during wort boiling, where the optimum pH is around pH 4.9, though a common boil pH is pH 5.2. A pH that is too high will not only inhibit coagulation, but also promote browning due to the interaction of amino acids and reducing sugars.

Hop utilization during the wort boil is also affected by pH; as pH increases, the solubility of hop resins increase. A high pH also increases the release of tannins, resulting in a harsher taste, and tends to favor elevated microbial activity.

# Foodcare

HI99111

## Portable pH Meter

for Wine Analysis

- Simultaneous pH and temperature measurements on a large dual-line LCD display
- User-friendly two button design
- Application specific probe
- Durable IP67 waterproof casing
- Watertight probe connection
- Probe condition indicator
- Automatic pH calibration at one or two points within two memorized buffer sets (standard or NIST)
- On-screen calibration tags
- mV measurement for electrode check
- Selectable temperature unit (°C or °F)
- Auto-off function
- Battery life indication and low battery detection



HI99111 is a portable, microprocessor-based pH and temperature meter. Main features include: extended pH and temperature ranges; waterproof and compact casing; large dual-line display; low battery detection; automatic pH calibration at one or two points within two memorized buffer sets (standard or NIST); selectable temperature unit (°C or °F).

The FC10483 pH probe features an open junction with Clogging Prevention System (CPSTM) technology, has a built-in temperature sensor for simultaneous temperature compensated pH and temperature readings, and also contains a pH sensor preamplifier to provide measurements impervious to noise and electrical interferences.

- Optional shockproof silicon rubber boot
- Specially designed to protect your instrument from damage or impact

HI710028 Orange  
HI710029 Blue  
HI710030 Green



### Specifications

### HI99111

pH	Range*	-2.00 to 16.00 pH / -2.0 to 16.0 pH
	Resolution	0.01 pH / 0.1 pH
	Accuracy (@25°C/77°F)	±0.02 pH / ±0.1 pH
pH-mV	Range*	±825 mV
	Resolution	1 mV
	Accuracy (@25°C/77°F)	±1 mV
Temperature	Range*	-5.0 to 105.0°C; 23.0 to 221.0°F
	Resolution	0.1°C; 0.1°F
	Accuracy (@25°C/77°F)	±0.5°C (up to 60°C), ±1.0°C (outside); ±1.0°F (up to 140°F), ±2.0°F (outside)
Additional Specifications	Temperature Compensation	automatic, from -5.0 to 105.0°C (23.0 to 221.0°F)
	Probe (included)	FC10483 preamplified pH and temperature probe with a flat tip, DIN connector, and 1 m (3.3') cable
	Battery Type / Life	1.5V AAA (3) approx. 1400 hours of continuous use
	Auto-off	user selectable: after 8 min, 60 min, or disabled
	Environment	0 to 50°C (32 to 122°F); RH max. 100%
	Meter Dimensions	154 x 63 x 30 mm (6.1 x 2.5 x 1.2")
	Meter Mass (with batteries)	196 g (6.91 oz.)
Case Ingress Protection Rating	IP67	
Ordering Information	<p><b>HI99111</b> is supplied with FC10483 pH/temperature probe with flat tip and Quick Connect DIN connector with 1m (3.3') cable, pH 3.00 and 7.01 buffer sachets, HI700635 Cleaning solution for wine deposits sachets (2), HI700636 Cleaning solution for wine stains (2), 100 mL beaker, 1.5V AAA batteries (3), calibration certificate of meter, calibration certificate of probe, instruction manual, and HI710142 rugged carrying case.</p>	

\* the FC10483 is limited to be used from 0 to 12 pH and from 0 to 80°C temperature (32 to 176 °F).





## FC10483 pH electrode

- PE sleeve for cleaning
- Refillable pH electrode
- Clogging prevention system (CPS™)

The HI99111 portable pH meter for wine uses the glass body FC10483 pH electrode with Hanna's unique Clogging Prevention System (CPS™). This electrode provides a fast stable response and resists clogging. The electrolyte solution in the electrode is refillable.

An integral part of any pH electrode is the reference junction. The reference junction allows for the flow of ions located in the reference cell into the sample being measured. The ions provide for an electrical connection between the reference electrode and the indicating electrode. A standard pH electrode will use a single ceramic junction; however, the CPS™ (Clogging Prevention System) is an innovation in electrode technology. Conventional pH electrodes use ceramic junctions that clog quickly when used in wine. When the junction is clogged, the electrode does not function. CPS™ technology utilizes the porousness of ground glass coupled with a PE sleeve to prevent clogging of the junction. The ground glass allows proper flow of the liquid, while the PE sleeve repels dirt. As a result, pH electrodes with CPS™ stay fresh up to 20 times longer than conventional electrodes.

To optimize the flow from the electrode the refill cap should be unscrewed so that it is open. This allows for positive head pressure to be created allowing for the electrolyte to drain more easily from the reference electrode.

### The Importance of pH in Wine Making

The pH of wine is important to determine because it will affect the quality of the final product in terms of taste, color, oxidation, chemical stability, and other factors. Generally in winemaking, the higher the pH reading, the lower amount of acidity in the wine. Three important factors in determining the pH of wine include the ratio of malic acid to tartaric acid, the amount of potassium, and the total amount of acid present.

Most wines optimally have a pH between 2.9 and 4.0, with values differing based on the type of wine. Values above pH 4.0 indicate that the wine may spoil quickly and be chemically unstable. Lower pH values allow the wine to stay fresher for a longer period and retain its original color and flavor. High pH wine is more likely to breed bacteria and become unsuitable to drink.

For finished white wines, the ideal pH is between pH 3.00 and pH 3.30, while the final pH for red wine is ideally between pH 3.40 and pH 3.50. The optimal pH before the fermentation process is between pH 2.9 and pH 4.0. The pH of wine therefore not only affects the color of wine, but also the oxidation, yeast fermentation, protein stability, and bacterial growth and fermentation.

# Portable pH Meter

for Skin and Scalp

- Simultaneous pH and temperature measurements on a large dual-line LCD display
- User-friendly two button design
- Application specific probe
- Durable IP67 waterproof casing
- Watertight probe connection
- Probe condition indicator
- Automatic pH calibration at one or two points within two memorized buffer sets (standard or NIST)
- On-screen calibration tags
- mV measurement for electrode check
- Selectable temperature unit (°C or °F)
- Auto-off function
- Battery life indication and low battery detection



HI99181 is a light weight, portable, pH, and temperature meter supplied with a specially designed pH electrode intended for the direct determination of pH on skin and scalp.

Researchers monitoring the compatibility between skin and cosmetics or pharmaceuticals use pH as essential marker of compatibility. The skin mantle has an acidic pH, ranging from pH 4 to 6. The acidic pH is a deterrent toward harmful microbes, pollution, and toxins. Age, genetics, sweat, and moisture can alter the pH of skin. Products are constantly created to restore the pH balance of skin and a reliable pH measurement of skin provides the scientific metrics.

The HI99181 portable pH meter together with a HI14143/50 combination pH electrode (when immersed in a drop of water on the skin surface), can determine the pH of the skin with high accuracy and repeatability.

The HI14143/50 probe offers numerous features that improve pH testing for skin measurements. The flat tip of the HI14143/50 provides optimal contact between the sample and the sensor.



- **Optional shockproof silicon rubber boot**
  - Specially designed to protect your instrument from damage or impact

HI710028 Orange  
HI710029 Blue  
HI710030 Green

## Specifications

## HI99181

pH	Range*	-2.00 to 16.00 pH / -2.0 to 16.0 pH
	Resolution	0.01 pH / 0.1 pH
	Accuracy (@25°C/77°F)	±0.02 pH / ±0.1 pH
pH-mV	Calibration	Automatic, one or two-point selectable bufferset standard: 4.01; 7.01; 10.01 or NIST: 4.01; 6.86; 9.18
	Range*	±825 mV
	Resolution	1 mV
Temperature	Accuracy (@25°C/77°F)	±1 mV
	Range*	-5.0 to 105.0°C; 23.0 to 221.0°F
	Resolution	0.1°C; 0.1°F
Additional Specifications	Accuracy (@25°C/77°F)	±0.5°C (up to 60°C), ±1.0°C (outside); ±1.0°F (up to 140°F), ±2.0°F (outside)
	Temperature Compensation	automatic, from -5.0 to 105.0°C (23.0 to 221.0°F)
	Probe (included)	HI14143/50 preamplified pH and temperature probe with flat tip 50 mm-long body, DIN connector, and 1 m (3.3') cable
Ordering Information	Battery Type / Life	1.5V AAA (3) approx. 1400 hours of continuous use
	Auto-off	user selectable: after 8 min, 60 min, or disabled
	Environment	0 to 50°C (32 to 122°F); RH max. 100%
	Meter Dimensions	154 x 63 x 30 mm (6.1 x 2.5 x 1.2")
	Meter Mass (with batteries)	196 g (6.91 oz.)
	Case Ingress Protection Rating	IP67
<b>Ordering Information</b>		<b>HI99181</b> is supplied with HI14143/50 pH/temperature probe with flat tip, 50 mm-long body, Quick Connect DIN connector and 1m (3.3') cable, pH 4.01 and 7.01 buffer sachets, HI700620 cleaning and disinfection solution sachet for skin residuals, HI700621 cleaning solution sachet for skin grease and sebum, 100 mL beaker, 1.5V AAA batteries (3), calibration certificate of meter, calibration certificate of probe, instruction manual, and HI710142 rugged carrying case.

\* the HI14143/50 is limited to be used from 0 to 12 pH and from 0 to 50 °C temperature (32 to 122 °F).

HI8424

## General Purpose pH/mV Meter

- Automatic Temperature Compensation (ATC)
- Waterproof
  - Compact, heavy-duty, and waterproof protected casing
- Two-point calibration
  - Automatic one or two-point calibration
- HOLD function
  - Holds stabilized pH value on LCD
- Battery indicator
  - Low battery indicator

The HI8424 is a highly accurate, portable pH/mV meter. It is one of the most popular pH meters on the market. This instrument is able to perform pH, mV, and temperature measurements with a high degree of accuracy and fast response.

Calibration is automatic at one or two points, with three memorized buffer values (pH 4.01, pH 7.01 and pH 10.01). Once the instrument has been calibrated, the buffer values used during calibration are displayed with tags on the LCD. This feature keeps users informed of the current calibration and helps to avoid taking measurements that are out of range.

Users can exchange the pH probe for an ORP probe to obtain ORP readings in the mV range. The HI8424 also offers measurements in °C and °F and has an auto-off feature to preserve battery life.



### Specifications

### HI8424

pH*	Range	-2.00 to 16.00 pH
	Resolution	0.01 pH
	Accuracy	±0.01 pH
	Calibration	one or two-point, three standard buffers available (4.01, 7.01, 10.01)
	Temperature Compensation	automatic from -20.0 to 120.0°C (-4.0 to 248.0°F) or manual without temperature probe
mV	Range	±699.9 mV; ±1999 mV
	Resolution	0.1 mV; 1 mV
	Accuracy	±0.2 mV; ±1 mV
Temperature*	Range	-20.0 to 120.0°C; -4.0 to 248.0°F
	Resolution	0.1°C; 0.1°F
	Accuracy	±0.4°C; ±0.8°F
Additional Specifications	pH Electrode	HI1230B PEI body pH electrode with BNC connector and 1 m (3.3') cable (included)
	Temperature Probe	HI7662 stainless steel temperatures probe with 1 m (3.3') cable (included)
	Slope / Offset Calibration	from 75 to 110% / ±1 pH
	Input Impedance	10 <sup>12</sup> Ohm
	Battery Type / Life	9V / approximately 150 hours of continuous use
	Auto-off	after 20 minutes of non-use (can be disabled)
	Environment	0 to 50°C (32 to 122°F); RH max 100%
	Dimensions / Weight	164 x 76 x 45 mm (6.5 x 3.0 x 1.8") / 180 g (6.3 oz.)
Ordering Information	<b>HI8424</b> is supplied with HI1230B pH electrode, HI7662 temperature probe, HI70004 pH 4.01 buffer solution sachet, HI70007 pH 7.01 buffer solution sachet, HI700601 electrode cleaning solution sachets (2), battery, protective case, and instructions.	
Accessories	<b>HI710015</b> blue shockproof rubber boot	

\* Limits will be reduced to actual sensor limits

# Analog pH/mV Meters

- Automatic Temperature Compensation (ATC)
- Two-point Calibration
- Water-resistant
  - Compact, heavy-duty casing
- Battery indicator
  - Low battery indicator
- Auto shut-off

The HI83141-1 and HI8314-1 are portable pH/mV meters designed to be accurate, reliable and easy to use.

The HI8314-1 uses the HI1217-1 pre-amplified pH electrode with built-in internal temperature sensor.

The HI83141-1 uses the HI1230B pH electrode and HI7669-1 temperature probe using separate connections.

Manual calibration is performed at one or two points by adjusting the trimmers on the front panel. Capable of measuring pH/mV and temperature, these meters are great for field work, providing one meter for multiple uses.

This instrument is ideal for applications that require a custom calibration point. Manual calibration can be extremely useful in order to achieve better accuracy.

These instruments can also be used for ORP measurements with the optional probes below:

HI83141-1: **HI3131B**

HI8314-1: **HI3618D-1**



Specifications	HI83141-1	HI8314-1	
pH*	Range	0.00 to 14.00 pH	0.00 to 14.00 pH
	Resolution	0.01 pH	0.01 pH
	Accuracy	±0.01 pH	±0.01 pH
	Calibration	manual, two-point, via trimmers	
	Temperature Compensation	automatic, 0 to 70°C (32 to 158 °F)	
mV	Range	±1999 mV	±1999 mV
	Resolution	1 mV	1 mV
	Accuracy	±1 mV	±1 mV
Temperature*	Range	0.0 to 100.0°C; 32.0 to 212.0°F	0.1°C; 0.1°F
	Resolution	0.1°C; 0.1°F	0.1°C; 0.1°F
	Accuracy	±0.4°C; ±0.8F (excluding probe error)	
Additional Specifications	pH Electrode	HI1230B PEI body pH electrode with BNC connector and 1 m (3.3') cable (included)	HI1217-1 PEI body, pre-amplified pH electrode with internal temperature sensor, DIN connector, and 1 m cable (included)
	Temperature Probe	HI7669-1 stainless steel temperature probe, BNC connector (included)	-
	Slope / Offset Calibration	from 80 to 110% / ±1 pH	
	Battery Type / Life	9V / approximately 450 hours of continuous use	
	Auto Shut-Off	after 8 minutes of non-use	
	Environment	0 to 50°C (32 to 122°F); RH max 95% non-condensing	
	Dimensions	145 x 80 x 36 mm (5.7 x 3.1 x 1.4")	
	Weight	230 g (8.1 oz.)	
	Ordering Information	<p><b>HI83141-1</b> is supplied with HI1230B pH electrode and HI7662 temperature probe, HI70004 pH 4.01 buffer solution sachet, HI70007 pH 7.01 buffer solution sachet, HI700601 electrode cleaning solution sachets (2), calibration screwdriver, battery, protective case, and instructions.</p> <p><b>HI8314-1</b> is supplied with HI1217-1 pH electrode, HI70004 pH 4.01 buffer solution sachet, HI70007 pH 7.01 buffer solution sachet, HI700601 electrode cleaning solution sachets (2), calibration screwdriver, battery, protective case, and instructions.</p>	
	Accessories	<p><b>HI710007</b> blue shockproof rubber boot</p> <p><b>HI710008</b> orange shockproof rubber boot</p>	

\* Limits will be reduced to actual sensor limits

HI931001 · HI9310014

## pH/mV Precision Simulators

- Simulate pH or ORP sensors to troubleshoot your meter
- Simulate temperature
- Provided with universal BNC connector

Sometimes it is difficult to recognize whether a particular malfunction is due to the meter or the electrode. By simply connecting HI931001 or HI9310014 (Pool Line) to your meter's input socket and turning the dials, pH readings can be simulated from 0 to 14 pH in 0.01 steps. The output signals all correspond to pH values at 25°C.

For the mV range, these meters can simulate output from -1000 to +1000 mV in 1 mV steps.



*Pool  
Line*

Specifications	HI931001	HI9310014
pH*	Range	0.00 to 14.00 pH
	Resolution	0.01 pH
	Accuracy	±0.01 pH
mV	Range	-1000 to 1000 mV
	Resolution	1 mV
	Accuracy	±1 mV
Additional Specifications	Impedance Test	-
	Temperature Compensation	all output values are simulated at 25°C
	Battery Type / Life	9V / approximately 500 hours of use
	Weight	320 g (11.3 oz.)
	Environment	0 to 50°C (32 to 122°F); RH max 95%
	Dimensions	185 x 82 x 53 mm (7.3 x 3.2 x 2.1")
Ordering Information	HI931001, and HI9310014 are supplied with HI7858/1 BNC/BNC coaxial cable	
Accessories	HI710009 Blue shockproof rubber boot	

\* Limits will be reduced to actual sensor limits

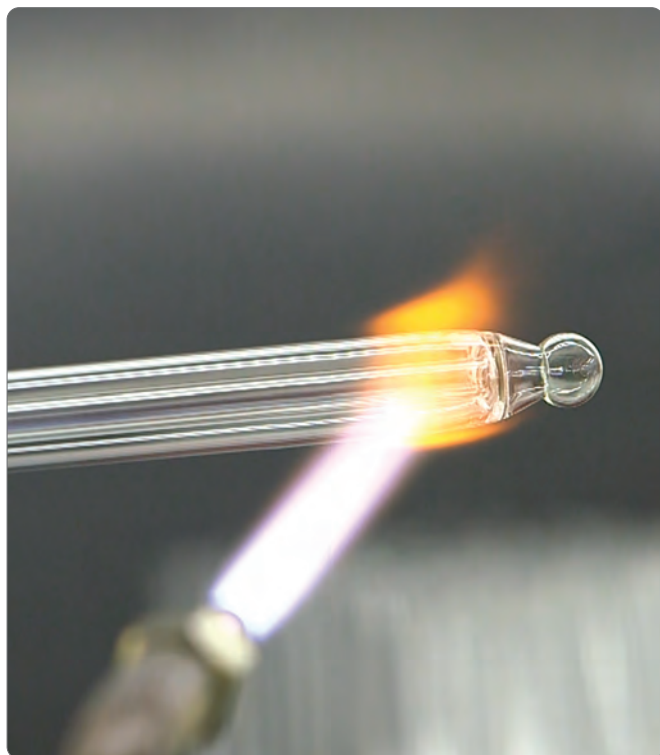

## At the Forefront of Electrode Technology

Hanna is the largest family-owned manufacturer of scientific analytical instrumentation, and a major European producer of electrodes. Hanna has helped propel the field of sensor technology with its innovative methodology. The Hanna line of pH electrodes is produced in state of the art manufacturing facilities, and is available with glass or thermal plastic bodies.

In 1981, Hanna developed its own formulation for sensing glass with the help of the Experimental Institute for Glass in Murano Italy. From that point forward, the company has continued to offer these premium pH sensing glass electrodes that cannot be imitated. While other companies have reduced their offerings, Hanna has continued to expand their electrode line to support a multitude of specific applications. An extensive variety of cleaning and maintenance solutions are also available to keep electrodes at peak performance.

### pH Electrode Manufacturing

Other electrode producers use the continuous fusion technique in crucibles with induction furnaces. In this practice, the glass is exposed to the fusion temperature for hours, where it is difficult to retain the quality of the product due to the evaporation of some of its components. Hanna uses glass blowing technology typical of the Murano masters, with sensitive glass sticks fused in controlled batches. Only this technique, which exposes the sensitive glass to the high fusion temperature for a matter of seconds, can guarantee the consistency and quality of the pH half-cell.

## pH Theory and Measurement

The most common pH measurement system utilizes glass pH electrodes. The system consists of a pH sensor (whose voltage varies proportionately to the hydrogen ion activity of the solution), a reference electrode (which provides a stable and constant reference voltage), a conductive measurement solution, and a special meter to measure and display the pH.

The pH sensor incorporates a thin membrane of hydrogen-sensitive glass blown on the end of an inert glass tube. This tube is filled with a buffered electrolyte and an Ag/AgCl wire. This system is called a pH half-cell.

A complementary system produces a constant voltage; it also contains a Ag/AgCl wire and an electrolyte (often a KCl solution saturated with AgCl). A small "filter", often a porous ceramic component, connects this tube to the external sample. This system is called a reference half-cell.

The meter measures the voltage difference between the pH half-cell and the reference half cell in DC millivolts. The measurement is read by the meter and displayed in either mV or pH units. The mV response by a pH electrode follows the Nernst Equation:

$$E^{obs} = E^c + \ln(10)(RT / nF)(\log[a_{H^+}])$$

- $E^{obs}$  = Observed potential
- $E^c$  = Reference potential including other stable and fixed potentials
- $a_{H^+}$  = The hydrogen ion activity
- $T$  = Temperature in Kelvin ( $C^\circ + 273.15$ )
- $n$  = Valence of the ion measured (1)
- $F$  = Faraday's constant ( $9.6485 \times 10^4$ )
- $R$  = Gas constant ( $8.31432J / KMol$ )

From this equation one can see that if the temperature (T) changes, the term  $\ln(10)RT / nF$  known as the slope factor, will change also. The table below illustrates the change in slope factor for changes in temperature.

Temperature (°C)	Slope Factor (mV/pH)
05	55.18
10	56.18
15	57.18
20	58.17
25	59.16
30	60.15
35	61.14

### How Temperature Affects Solution pH

Samples change pH as a function of temperature due to changes in ion dissociation; as temperature increases, ion activity also increases. An example of this is pH buffers, whose well-characterized values are published on the buffer bottles. With very pure water, a change of ~1.3 pH is observed between 0 and 100°C. This example shows that even a neutral solution can have a large temperature coefficient. All samples have a temperature coefficient that is variable for actual samples. Changes in pH due to the sample temperature coefficient are not compensated for. There is, however, an exception to this; because buffers are well-characterized, they are compensated for during calibration on intelligent pH meters. The buffers will display a 25°C value during calibration but will change after the calibration to read their actual pH at the temperature of measurement.

## pH Measuring System

### pH Electrode

The sensor half-cell of an electrochemical cell is typically composed of a special glass membrane that responds to a hydrogen ion concentration.

### Reference Electrode

The half-cell of an electrochemical cell that supplies a stable voltage that is known, constant, and completely insensitive to the measurement solution. Changes in voltages generated from the pH sensor are measured versus this electrode's voltage.

### High Input Impedance Meter

The measurement device that processes the voltage from the electrochemical cell and converts it into a meaningful measurement unit (pH). The measurement is done with virtually zero current flow to prevent polarization of the electrodes. Modern pH meters also may provide sensor diagnostics, automatic buffer recognition, calibration reminders and user prompts.

### Chemical pH Buffers

Buffers are stable, well-characterized standards used for calibration. Two or more pH buffers that bracket the sample pH range are suggested for the most accurate results.

### Thermometer or Temperature Probe

A temperature measurement is desired during calibration and measurement to make adjustments to the Nernst slope factor. An auxiliary or built-in temperature probe ensures both calibration and measurement are automatically temperature compensated, thus eliminating error.

### Magnetic Stirrer

Used in a laboratory setting, a magnetic stirrer together with magnetic stir bars continually agitate the buffer and/or samples to keep them homogenous, eliminating temperature or sample gradients.



## Electrode Design

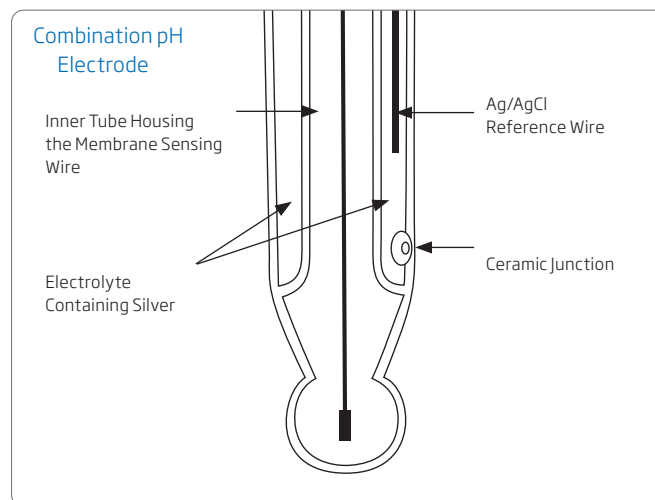
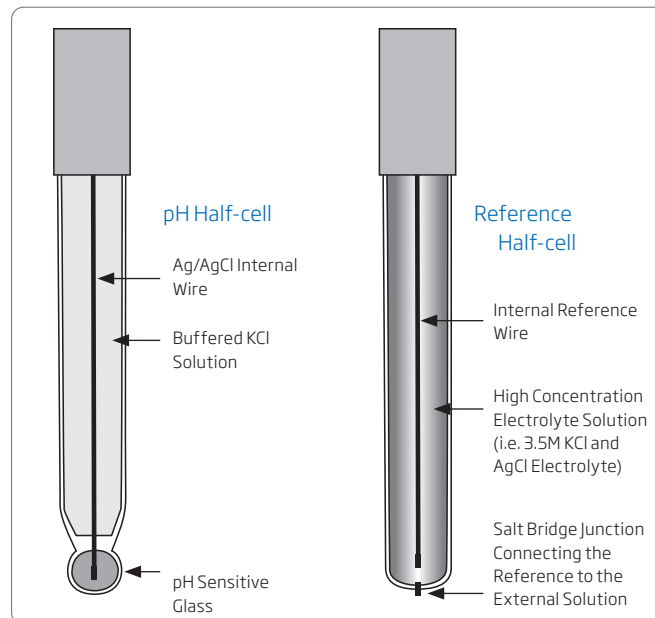

### Half-cells vs. Combination pH electrodes

Until the 1970s, it was a common practice to offer two half cells separately, a glass pH sensor and a reference electrode. Today it is more common to use a single combined electrode that has both sensing and reference components. Reference electrodes still enjoy use in other electrochemical techniques and their use is often preferred with ion selective electrodes (ISE) half-cells.

## Single Junction vs. Double Junction

Conventional electrodes are normally single junction. As depicted by the figure below, these electrodes have only a single junction, which serves to put the reference electrode system in contact with the sample. Under adverse conditions, such as high pressure, high temperature, highly acidic or alkaline solutions etc., the positive flow of the electrolyte through the junction is often reversed resulting in the ingress of sample solution into the reference compartment. If this is left unchecked, the reference electrode can become contaminated, leading to complete electrode failure. Another potential problem with single junction electrodes is the clogging of the junction due to AgCl precipitation. AgCl is less soluble in the sample than the reference electrolyte solution. Therefore, when the electrolyte solution makes contact with the sample, some AgCl will precipitate on the external face of the junction. The result is drift readings obtained from the sensor.

Hanna's double junction system, as the name implies, has two junctions, only one of which is in contact with the sample as shown in the figure below. Under adverse conditions, the same tendency of sample ingress is possible. However, as the reference electrode system is separated physically from the intermediate electrolyte area, the contamination of the electrode is minimized. The likelihood of clogging of the junction is also reduced with a double junction electrode since the outer reference cell uses a fill solution that is "silver-free." Since there is no silver present, no precipitate can form to clog the junction.

*Single junction electrodes use a fill solution such as the HI7071 that contains 3.5M KCl + AgCl, while double junction electrodes typically use HI7082 that contains 3.5M KCl.*

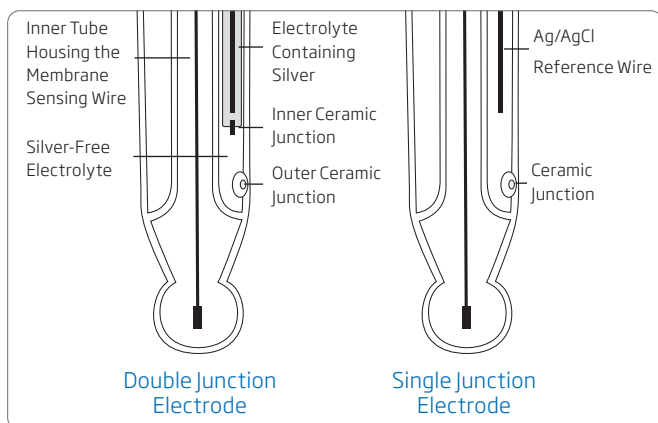

## Types of Junctions:

### Porous Ceramic

Normally used in electrodes with glass bodies because ceramic with the correct expansion coefficient is easily welded to glass. Ceramic is available with different porosities and diameters. It may also be referred to as a diaphragm.



### Porous PTFE (Polytetrafluoroethylene)

Porous PTFE is a hydrophobic material that is available with different porosities. Because of its chemical resistance, PTFE is widely used in industrial applications.

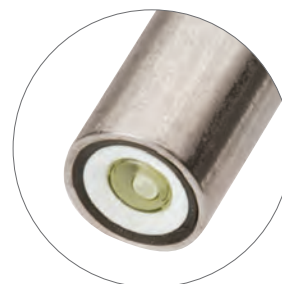

### Fiber Wick

This type of junction is often used on plastic bodied electrodes with gel electrolytes.

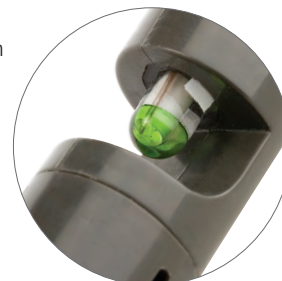

### Open Junction

This type of junction is often found in foodcare pH electrodes and is filled with a special gel which comes into direct contact with the solution to be measured. An advantage of an open junction is low contact resistance and low clogging potential.

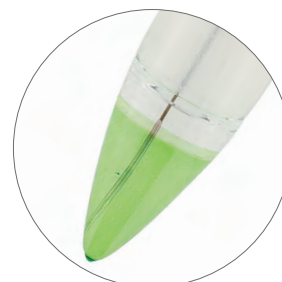

### Cone Style

This style junction is also renewable. As the sleeve or collar is moved, fresh fill solution cleans out the junction with fresh electrolyte. This has a higher flow rate than a ceramic type and is often specified for ISE measurements.

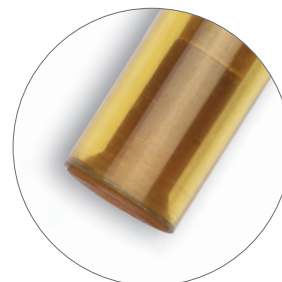

*Other types of junctions include:*

### Capillary Junction

This type of junction can be made with smooth or frosted glass. The advantage of a capillary junction is a fast flow rate and an open channel. It is typically used with thickened electrolytes.

### Open Platinum

This style junction is made by partially sealing fine Pt wires through the stem glass, creating a leakage path. These have high flow rates.

### Fiberglass

This style junction is very similar to a fiber wick. The junction is typically renewable and may have a high flow rate depending on strand number in the bundle.



## Four Different pH Sensitive Glass Formulations

Application driven design has influenced our offering of pH glass formulations. Hanna has selected the best glass compositions possible for each sensor to ensure the most accurate measurements in a given application. The characteristics of the sensitive glass used in the manufacture of pH electrodes are extremely important in determining how the electrode will respond. Characteristics of pH glass include workability (what shapes can be made with a certain glass composition), impedance of the glass (influenced by shape and thickness), pH range, alkaline error, acid error, hydrofluoric acid resistance and abrasion resistance.

Hanna utilizes four different types of pH sensitive glass to cover the vast number of applications. For instance, some electrodes with low impedance glass are particularly suited at performing measurements in solutions with low conductivity or cold solutions. As a general rule, the pH of glass impedance doubles for every 10°C (50°F) drop in temperature. Very high impedance results in a very noisy, erratic signal that is prone to errors in measurement. Hanna offers low temperature (LT) glass, a low impedance glass for these applications. At elevated temperatures, glass can dissolve readily, shortening the life and performance of the sensor. Hanna offers high temperature (HT) glass for these applications.

### GP Glass

Hanna's general purpose (GP) hydrogen sensitive glass provides the best response over the entire pH range and can be used for a wide range of applications. Great results are obtained with a sphere geometry with a diameter of 9.5 mm (0.37"), achieving a system with 100 MΩ impedance. The GP glass is also used on smaller diameter spheres. As the diameter of the sphere is reduced, the system impedance increases. The response time then increases from the usual 2 seconds for the 9.5 mm (0.37") sphere to about 6 seconds with a 3 mm (0.12") sphere. The color of the GP glass is green.

### LT Glass

Due to low impedance, LT glass is used on flat and conical shaped membranes, as well as sensors used at cold temperatures. If an electrode has very high impedance, the measurement response will be sluggish, and a voltage drop causing error can occur. At temperatures below -8°C (17°F) the internal buffer may freeze and expand, causing the mechanical destruction of the sensor. This glass has a more limited pH range, and is colored dark green.

### HT Glass

Designed for extended use at elevated temperature, the impedance of HT glass has a temperature coefficient of about 14.3% per degree Celsius. HT sensitive glass has an impedance of 400 MΩ at approximately 25°C (77°F). At extremely high temperatures the impedance drops significantly; HT glass makes it possible to obtain accurate, high temperature pH measurements for extended periods of time at 90°C (194°F) and for several weeks at 100°C (212°F). At room temperature, the response time may increase so additional time for equilibration in buffers should be allowed. The color of HT glass is clear.

### HF Glass

Hydrofluoric acid can dissolve glass rapidly. Hanna uses HF resistant glass for aggressive applications that have fluoride ions. Electrodes manufactured with this glass live ten times longer than electrodes made with standard pH glass formulations (from 10 days to 100 days). The alkaline error is very high for this glass, so it is not suited for pH measurements above pH 10. The recommended pH range with this glass is from 2 to 10 pH and for samples with less than 2 g/L fluoride.

### Different Shaped Membranes (Tips)

The pH membranes used as the sensor on pH electrodes can be fabricated with different shaped membranes; spherical, conical, and flat tips are used in Hanna's products. For analysis of small samples, microelectrodes are also available.

A **spherical tip** is recommended for general use in aqueous or liquid solutions and provides a wide surface of contact with the sample.

A **conical tip** is recommended for semi-solid products, emulsions, cheese, meat, and food in general.

A **flat tip** is recommended for direct surface measurement on skin, leather, paper, etc.



Spherical

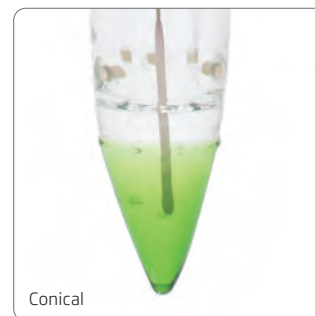

Conical

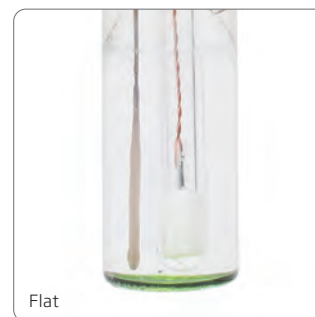

Flat

### Body Material

Combination pH electrodes are often made entirely of glass. The bodies of these electrodes are lead free glass, which is not pH sensitive. All glass electrodes are ideal for routine laboratory work because they respond quickly to temperature changes, are easily cleaned, and are compatible with organic solvents. However, in the hands of some, glass can be very breakable.

The electrode body can be made less fragile by incorporating an outer body made from a thermoplastic. Hanna uses PEI resin, PVDF and PP as examples of materials utilized for outer body construction. Some industrial sensors utilize additional materials such as PVC and/or titanium, the space age metal. A titanium body increases immunity to electrostatic and magnetic fields and features strong corrosion resistance, even in seawater. Our titanium bodied electrodes' outer casing also serves as a matching pin.

## Matching Pin

A matching pin is a differential measurement technique used to eliminate ground loops and common mode perturbations for a measurement system. In a system without a matching pin, electrical currents in the sample can affect the reference half cell voltage that is connected via the liquid junction with the sample. In this case, the reference electrode picks up the electromagnetic fields and the measurement of the pH is altered. The matching pin isolates these current/magnetic fields from the reference electrode. Hanna manufactures a number of models with the matching pin design for safe precise pH measurements.

## Types of Connectors

Most Hanna meters accept pH electrodes with one of the connectors listed below.

*The BNC connector is the most versatile since it can be used with any meter that utilizes BNC, regardless of brand.*

DIN, 3.5 mm, Screw, and T-type connections are generally proprietary to the meters they are supplied with. Screw and T-Type connectors attach directly to the meter.

Even though both Screw and T-type connectors attach directly to the meter, they can also be made interchangeable with other meters by using Hanna BNC extension cables.



## Water Conductivity and pH Measurement

pH is the measurement of hydrogen ion activity. Ultrapure water is the perfect solvent and readily dissolves many things. The pH glass surface can actually become dehydrated if stored or used in deionized or distilled water as ions are leached from the sensing surface. pH electrodes require ions in a solution, preferably with a conductivity of or exceeding 200  $\mu\text{S}/\text{cm}$  to function properly.

*In the case of low conductivity samples that are below 200  $\mu\text{S}/\text{cm}$ , we suggest the use of specific electrodes, such as the HI1053 which has LT glass suitable for low temperatures. This pH electrode has a triple ceramic junction that allows a higher flow rate of reference electrolyte to help provide electrical conductivity.*

## Alkaline Error

Alkaline error exists in high pH solutions when the hydrogen ions in the gel layer are partially or completely substituted with alkali ions; the resulting pH displayed is lower than it actually should be.

The difference between the theoretical and measured pH is called the alkaline error. Sodium ions are typically the ions that are responsible, but potassium and lithium ions can also contribute to this error. In earlier glass compositions, the alkaline error was seen to start at 9 pH. Newer glass formulations and ones especially formulated to minimize this error now exhibit an error starting at 12 or 13 pH.

To solve the problem of alkaline error, Hanna's high temperature (HT) glass minimizes alkali error in highly alkaline solutions. The tables below show the alkaline error that exists with Hanna glass types at ambient temperatures:

### Alkaline Error with 0.1 M Sodium

pH	GP	HT	LT	HF
10.0				
10.5				0.06
11.0				0.15
11.5			0.05	0.22
12.0	0.01		0.18	0.30
12.5	0.11	0.05	0.28	
13.0	0.23	0.11	0.35	
13.5	0.35	0.16	0.45	
14.0	0.48	0.20	0.54	

### Alkaline Error with 1.0 M Sodium

pH	GP	HT	LT	HF
10.0			0.01	0.25
10.5			0.14	0.25
11.0	0.02		0.30	0.48
11.5	0.11	0.01	0.46	0.71
12.0	0.21	0.06	0.62	
12.5	0.32	0.11	0.79	
13.0	0.43	0.15		
13.5	0.45	0.21		
14.0	0.65	0.27		

## Calibration

### pH Electrode Preparation Procedure

A clean, conditioned Hanna pH electrode will provide the best measurements possible. When using a new electrode, remove the protective bulb cap and inspect the electrode.

*As water may have evaporated during shipping or storage, salt crystals may be found in and around the protective cap or on the pH bulb, this is normal.*

Rinse off with water. During transport, air bubbles may have formed inside the glass bulb. Shake down the electrode as you would with a spirit filled thermometer. Condition the sensing tip; soak the pH bulb and junction in HI70300 storage solution for at least one hour or longer. If possible, an overnight soak is best. This will hydrate a dehydrated glass sensor and thoroughly wet a dried reference junction.

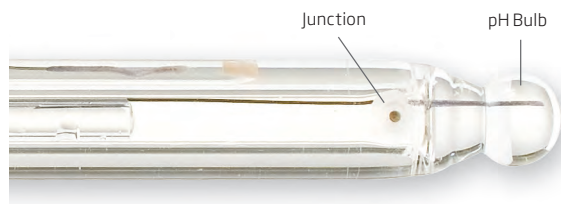

### Rinse Electrode with Purified Water

Prior to placing the electrode in calibration solution, it should be thoroughly rinsed with clean, purified water to prevent any contamination to the pH buffer. The electrode should always be rinsed with purified water after placing it in any solution.

### Use Fresh pH Buffer for Calibration

The calibration of the pH electrode is only as good as the buffer used. Once a bottle of buffer is open, it should be discarded after six months of use. To prevent cross-contamination, never pour buffer back into the bottle. If the same buffer is to be used for multiple calibrations, it is better to pour a small amount of buffer in a separate container that can be sealed. If using a separate container, the buffer should be changed frequently (i.e. daily, weekly).

*It is important to note that pH buffers at higher values (i.e. pH 10.01) are less stable than lower values, this is due to atmospheric CO<sub>2</sub> diffusing into the buffer, forming carbonic acid. If the buffer is old, the actual value might be less than stated on the bottle, resulting in a low slope.*

### Open Reference Fill Cap on Refillable Electrodes

If using a refillable pH electrode, the fill cap should be removed prior to calibration and measurement. Removing the cap creates positive head pressure in the reference cell allowing for higher flow rate of electrolyte through the outer junction. A higher flow rate will result in a faster and more stable reading.

### Submerge Electrode Past Junction

It is critical that the junction of the electrode be completely submerged in the pH buffer or sample. Failure to do so will result in erratic readings.



### Use a Magnetic Stirrer

For benchtop meters, it is beneficial to use a magnetic stirrer. A magnetic stirrer will ensure that the pH buffer or sample is homogenous. The movement of the solution will also increase the response time of the electrode in the solution.

### One-point Calibration

For one-point calibration it is important to calibrate the pH electrode in pH 7.0. This calibration determines the offset value. The mV value at pH 7.00 ideally should be 0.0.

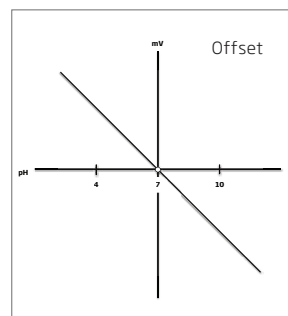

### Multiple-point Calibration

For improved accuracy it is recommended to calibrate a minimum of two points. The second point determines the slope of the line. It is important to use buffers that bracket the expected value of the sample to be tested. For example, if the expected value is pH 8, the electrode should be calibrated using pH 7.01 and pH 10.01 buffer.

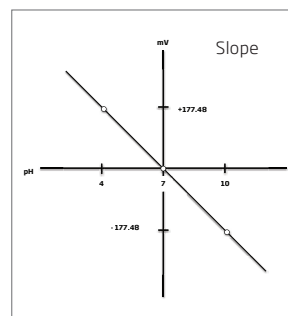

### Electrode Fill Solutions

The electrolyte level in refillable electrodes should be checked before performing any calibration. If the level is low (1 cm or 1/2" below fill hole), refill with the proper electrolyte solution to ensure the optimum electrode performance. This simple maintenance step helps guarantee adequate head pressure to promote efficient and precise reading.

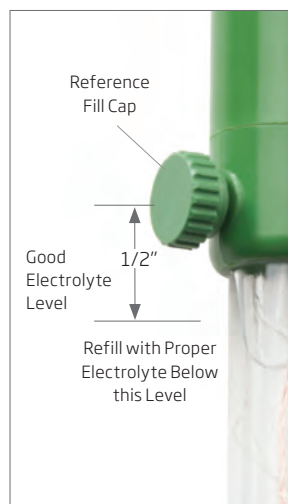

*Always use the appropriate fill solution for your pH electrode. Typically single junction pH electrodes use the HI7071 electrolyte solution (3.5M KCl + AgCl) while double junction pH electrodes use HI7082 electrolyte solution (3.5M KCl).*

## Maintenance and Storage

### General Maintenance Tips

Periodically check the offset and slope characteristic of the pH electrode.

If your meter does not have GLP (Good Laboratory Practice) capability to display this information, see below on how to use the mV function of a pH meter to determine offset and slope characteristics. A probe should have an offset (pH 7.01) voltage of  $\pm 30$  mV. Values outside this range could indicate that an electrode needs to be cleaned or the reference fill solution is contaminated. A probe should have a slope greater than 85% (50 mV/pH @ 25°C). Many Hanna meters will alert the user if the offset exceeds  $\pm 8.0$  mV or if the slope is less than 94%.

*If it is not possible to check offset and slope of the electrode with your meter, it is recommended to change the pH electrode yearly to ensure that accurate readings are obtained.*

How to calculate offset and slope

- Must have a pH meter that can be placed in mV mode
- Must use fresh buffers

The procedure below is based on calibration buffers at 25°C. At this temperature the theoretical 100% slope is 59.16 mV/pH change from pH 7.0. A pH electrode in calibration buffer at 50°C will generate 64 mV/pH, while at 0°C the response will be 54 mV/pH.

**Step 1** Measure mV of pH 7.01 buffer and record value

**Step 2** Measure mV value of pH 4.01 buffer and record value

**Step 3** Calculate the absolute mV difference  
(pH 4.01 value - pH 7.01 value)

Examples:

**Electrode 1** pH 7.01 = -15 mV  
pH 4.01 = +160 mV  
Absolute mV difference is  $+160 \text{ mV} - (-15 \text{ mV}) = +175 \text{ mV}$

**Electrode 2** pH 7.01 = +15 mV  
pH 4.01 = +160 mV  
Absolute mV difference is  $+160 \text{ mV} - (+15 \text{ mV}) = +145 \text{ mV}$

At 25°C pH 7.01 (offset) =  $\pm 30$  mV.

The absolute mV difference should be 150 mV (85% slope) to 186 mV (105% slope).

**Conclusion:** Electrode 1 is working properly while electrode 2 has an unacceptable slope. Try cleaning and if possible replace fill solution. If slope is still low then replace the pH electrode.

*Important note: A pH 7.01 mV value outside  $\pm 30$  mV is an indicator of a build up/coating on the pH bulb. The electrode should be cleaned.*

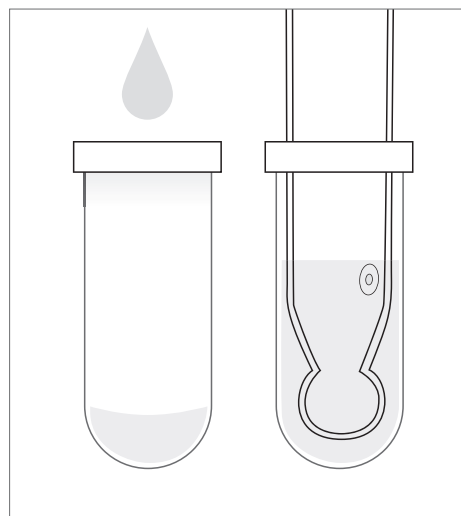

### Electrode Storage Solutions

To minimize junction clogging and ensure fast response time, always keep the glass bulb and the junction of your pH electrode hydrated. For benchtop meters used in the lab pour a small amount of the HI70300 storage solution in a small beaker and lower the electrode into it making sure that the junction is covered. For portable meters, store the electrode with a few drops of HI70300 storage solution in the protective cap.

Storage solutions are designed to keep the pH electrode hydrated while minimizing growth on the electrode from bacteria and algae. Placing a probe in water will result in a growth on the electrode that might not be visible to the naked eye. This growth will affect the performance and accuracy. To minimize growth it is recommended to use pH 4 buffer if storage solution is not available. Solutions with lower pH values can inhibit growth. If pH 4 buffer is not available, it is advisable to use pH 7 buffer.

**Never store a pH electrode in purified water as it will dehydrate the bulb.** The concentration of the fill solution is 3.5M KCl. The reference cell with this concentration generates a specific voltage. Placing a probe in purified water will have an osmotic effect causing water to move into the reference cell. There will also be a higher rate of diffusion of electrolyte from the reference cell into the water due to a concentration gradient. Both will result in a different reference electrolyte concentration, which will result in a change in the reference potential. If using a non-refillable probe in which the reference electrolyte cannot be changed, storage in purified water may result in premature failure and ultimately replacement of the electrode.

Inspect the electrode for any scratches or cracks on the bulb or stem.  
If any are present, replace the electrode.

## Electrode Cleaning

### Cleaning Procedure

The most common cause for pH measurement inaccuracies is an unclean or improperly cleaned electrode. This is very important to note, because during calibration, the instrument assumes that the electrode is clean and that the standardization curve created during the calibration process will remain a valid reference until the next calibration. pH meters on the market today will allow an offset voltage of approximately  $\pm 60$  mV. The deviation from 0 mV is not unusual but ideally should be no greater than  $\pm 30$  mV. The calibration process compensates for the change in offset voltage.

Calibrating a meter with a dirty electrode will result in inaccurate readings. If the mV offset continues to deviate with a properly cleaned electrode, it is a good indication that the electrode may need to be replaced.

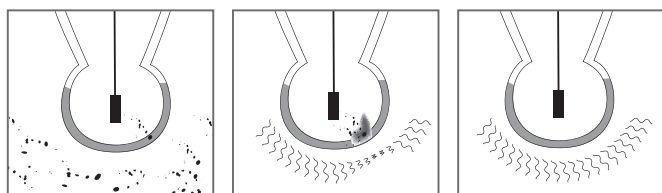

In time, particles during routine measurement can contaminate the sensor tip. Mishandled and aged solutions can also be affected.

Your meter can still be calibrated even if the electrode sensor tip is not properly cleaned before calibration. If the contamination dissipates, the calibration is no longer valid and the readings are inaccurate.

A proper cleaning and fresh solution ensures the whole surface of the sensor tip is reading correctly, ensuring an accurate calibration.

### General Cleaning

Soak in Hanna HI7061 General Cleaning Solution for approximately 30 minutes to dissolve mineral deposits and other general coatings.

### Protein Coating

Soak in Hanna HI7073 Protein Cleaning Solution for 15 minutes to enzymatically dissolve deposits from protein sources.

### Inorganic Soak

Soak in Hanna HI7074 Inorganic Cleaning Solution for 15 minutes. This cleaner is especially effective at removal of precipitates caused by reaction with the silver in the filling solution that may form on a ceramic junction.

### Oil and Grease Rinse

Oil and grease removal require the correct chemicals to solubilize the coating, but are mild enough to leave the electrode unaffected. Use Hanna HI7077 Oil and Fat Cleaning Solution.

*After performing any of the cleaning procedures, rinse the electrode thoroughly with purified water and then soak the electrode in HI70300 or HI80300 storage solution for at least 1 hour before taking measurements.*

## Troubleshooting

### Drifting/Erratic Readings

Potential problems include:

**Build up on glass electrode** - Clean electrode

**Clogged junction** - Depending on the material clogging the electrode, use application specific cleaning solutions. It may be possible to dissolve in high purity water or place in an acid such as 0.1M HCl or 0.1M HNO<sub>3</sub> at elevated temperature (50°C) for about an hour to clear the clog.

*If the junction is constantly clogging due to measuring in semi solids or viscous samples, use a pH electrode that has an open junction design or cloth junction.*

**Low conductivity solution** - Use an electrode that has a high flow rate or add high purity KCl to sample to increase EC.

**Electrode is not properly hydrated** - Soak in storage solution for at least 1 hour, if not longer.

### Frozen pH Reading

**Broken electrode** - Possible short between internal pH electrode and reference. pH meter displays the same value when placed in different buffers. The electrode should then be replaced.

### Inaccurate Reading:

**Improper calibration** - Make sure that pH electrode was rinsed with purified water between buffers to prevent cross-contamination and the electrode is at thermal equilibrium with the buffer.

Check offset and slope of electrode. Offset mV value in pH 7.0 should be  $\pm 30$  mV; if outside of this range, try cleaning the electrode. Slope (difference in mV from pH 7.0 to pH 4.0) must be greater than 150 mV (85%). If the slope is less than 85% then use fresh buffers, change fill solution, and clean electrode. If the slope cannot be increased to an acceptable value, replace electrode.

**Important note:** *A low slope can be due to a bad buffer. If calibrating to pH 7 and 10, it is possible that pH 10 buffer is no longer valid. pH 10 buffer is susceptible to diffusion of CO<sub>2</sub> from the air. When this happens, the pH 10 buffer will have a lower pH value and result in a low slope percentage value. Tracking the mV values of the buffer by writing the value on the bottle when opened is a way to have a reference point of a good buffer.*

*85% slope is the absolute threshold of an acceptable slope percentage. There are industries that require a slope of 90% or higher.*

## pH Electrodes

Designed and Manufactured by Hanna

**Calibrating and measuring at different temperatures**—Either use a meter that has automatic temperature compensation or calibrate and measure at same temperature. Note that the buffer pH at various temperatures is noted on the bottle.

**Measuring at high pH (>pH 10.0) introduces alkaline error**—Use a pH electrode that has HT glass to minimize alkaline error.

**Calibration with an electrode that was not clean**—Any coating that comes off the electrode during use will alter the electrode characteristic, resulting in the calibration being no longer valid.

**Electrical noise interference can interfere with obtaining an accurate pH measurement**—Noise from rectifiers in plating baths, motors or pumps can interfere with the high impedance measuring circuit.

### pH Electrode has a Short Life Span (< 6 months)

Elevated temperatures reduce the life span of pH electrodes. At room temperature (25°C) a pH electrode will typically last 1 to 2 years. A general rule is that for every 25°C increase the electrode life will decrease by ½. Temperature cycling has the most detrimental effect.

Operating Temperature	Average Lifespan
25°C	1 to 2 years
50°C	6 to 12 months
75°C	3 to 6 months
100°C	<1 month

*If measuring samples at temperatures greater than 50 °C, use a pH electrode with high temperature (HT) glass such as the HI1043.*

**Storing a pH electrode in purified water will shorten the life span of pH electrode**—If using a refillable pH electrode, replace fill solution; if using a gel-filled electrode, the electrode will have to be replaced. Store in storage solution.

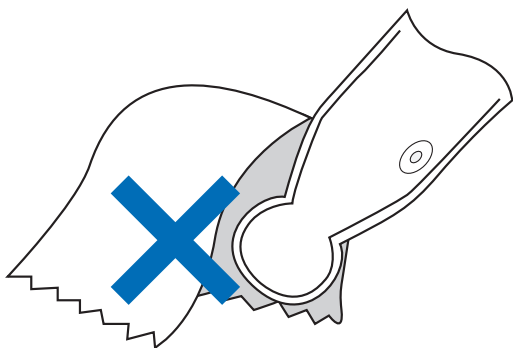

**Wiping a pH electrode with tissue will harm an electrode**—It is important to blot a pH electrode. Wiping the electrode can produce a static charge on the sensor that will destabilize the measurement thus requiring additional time before stable measurements can be obtained.

*Solutions with hydrofluoric acid will dissolve the glass at a pH less than pH 5. Use electrodes with HF resistant glass. The HI1143 will resist HF up to 2 g/L @ pH 2 and temperatures less than 60°C.*

## ORP Theory and Applications

### ORP (Oxidation Reduction Potential)

Similar to the manner in which acidic or alkaline solutions are quantified by pH measurements, solutions can also be graded as oxidizing or reducing based on measurements of ORP (sometimes called "redox").

When an oxidizing and/or reducing agent is dissolved into an aqueous sample, they may react with materials present and produce a voltage, or electromotive force (EMF), that is related to the ratio of oxidized to reduce species in the sample. An electron exchange can develop between this solution and an inert metal sensor immersed in the solution, and the voltage can be measured (when compared to a reference electrode) with a pH/mV meter. This type of measurement is known as redox or ORP. The units of measurement are in mV. At a glance, an ORP electrode may look very similar to a pH electrode. Like a combination pH electrode, both the sensor and the reference are housed in a common body.

The scale of measurement may be positive (indicating oxidizing potential) or negative (indicating reducing). It should be noted that when zero mV is observed, it is really an oxidizing situation because the reference voltage (~200 mV for an Ag/AgCl with KCl electrolyte) is included in the observed mV value. In some cases the user may wish to offset the reading to remove the reference contribution. The mV is then said to be approaching the absolute mV scale that references a SHE (standard hydrogen electrode). This type of calibration is called relative mV calibration.

An ORP sensor must be chemically inert; it cannot be oxidized or reduced itself. It must also have the proper surface characteristics to promote rapid electron exchange, a property known as high exchange current density. Two noble metals have proven to work well for this purpose: pure platinum and pure gold are both used in the construction of ORP sensors.

The platinum sensor is often preferred because it is mechanically simpler and safer to produce. Platinum can be welded to glass and has the same thermal coefficient. Sensors made of gold cannot be welded to the glass and are often placed in plastic supports applied to the glass or plastic tube by means of tiny elastomeric bungs. The gold or platinum sensor signal is carried through the electrode body, and together with the reference signal is conducted to the measurement meter via a coaxial cable with BNC connector.

An ORP system does not have a high impedance source (like a pH bulb), but is a potentiometric device that produces a voltage. It also uses similar cables, connectors, and calibration solutions. For this reason, a high impedance electronic meter (pH) with many user friendly features are a benefit for this measurement also.

Because of the close relationship between pH and ORP, there is a scale that takes into account the ratio (mV) ORP/pH, the rH scale. The rH range varies from 0 to 42, where the extreme values represent the reducing effect of an atmosphere of pure hydrogen (rH=0) and to the oxidizing effect of an atmosphere of pure oxygen (rH=42), respectively.

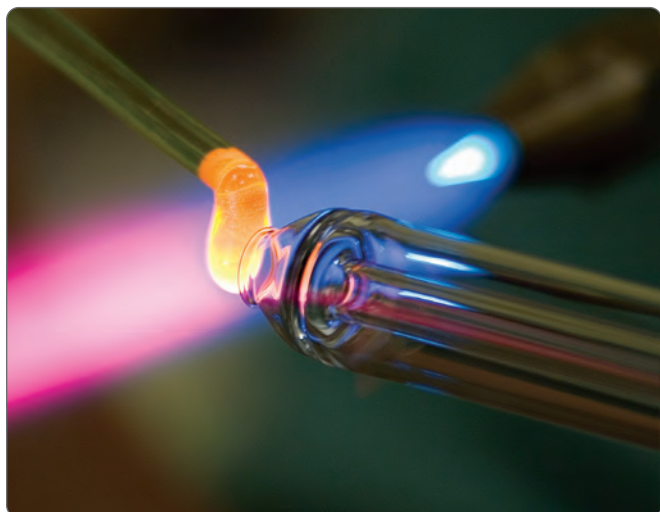

The formula for obtaining the rH value is as follows:

$$rH = \frac{mV}{0.0992 (273.15 + T_c)} - 2 \text{ pH}$$

In this equation, where T is the temperature (°C) of the sample, mV is the ORP (mV) reading, and pH is the pH value of the sample.

The rH scale is not used in the instruments available on the market. A direct mV reading from the electrode is preferred, within the  $\pm 2000$  mV range, without compensation/correlation with the pH/temperature value.

## ORP Applications

ORP measurements are based on the potential difference measured between the platinum or gold electrode and a reference electrode. The identical reference system utilized for the pH electrode (Ag/AgCl) is also used for redox measurements.

Redox electrodes are used to monitor many chemical processes particularly those involving reversible reactions. Common applications include the following:

### Industrial Wastewater Treatment

The redox systems used in water treatment are the reduction of chromates and oxidation of cyanides. Waste hexavalent chromium is reduced to trivalent chromium by the addition of sodium bisulfite or sulphur dioxide. In the case of cyanide, chlorine or sodium hypochlorite is used to oxidize the cyanide, followed by the hydrolysis of cyanate to ammonia and carbon dioxide.

### Water Sanitation

ORP measurements are being increasingly used as an effective measure of the sanitizing activity in pool, spa, and potable water. The kill time of E. coli bacteria in water depends on the ORP value. ORP is a reliable indicator of bacteriological water quality. Water having an ORP value equal to or higher than 650 mV are well within accepted sanitization levels for pool and spa waters.

## Electrode Feature Guide: A Quick Glance

### CAL Check™ System

When used in tandem with a Hanna CAL Check meter, our CAL Check equipped electrodes allow users to be informed if they have performed a proper calibration. In the event of a dirty or broken electrode or contaminated buffer solution, the system alerts the user to either check the electrode, replace the buffer solution, or both. The system also reminds users when the instrument should be recalibrated.

### Smart Electrodes

With models that feature our SMART circuitry, an exclusive microchip embedded inside the electrode retains the calibration data and assigns an identity code to the host unit. As soon as the electrode is connected to a pH meter in the SMART series, it is recognized and its characteristics retrieved. The meter then uses the accessed calibration data as a reference for future measurements. Once each SMART electrode is calibrated, these electrodes can be used in succession without requiring new calibration. Hanna's SMART electrodes help eliminate errors and save time when working with more than one electrode.

### Pre-amplified Electrodes

Pre-amplifiers are encapsulated in many of Hanna's pH electrodes. The pre-amplifier converts the high impedance signal from the pH glass to a low impedance signal; this allows the user to use long runs of sensor cable with ordinary connectors without noise or voltage drops that result in erroneous measurements.

### Clogging Prevention System (CPS™)

Conventional pH electrodes use ceramic junctions that may clog quickly when used in biological samples, such as wine or must. When the junction is blocked, the entire electrode will not function properly. Electrodes that feature CPS technology utilize a ground glass/PE sleeve junction which controls a steady, predictable flow of fill solution, thus keeping the junction open. The hydrophobic property of PE sleeve repels wetness and coatings.

### Sensor Check™ for edge® Meters

When used with Hanna's electrodes equipped with a matching pin, edge constantly checks the impedance of the pH measuring electrode to notify the user, in real-time, in the event of glass breakage. During calibration, Sensor Check also verifies the state of the junction.

### Titanium Casings

Our electrodes that feature titanium bodies offer durability and shielding that is required in many industrial applications.

## pH Electrode Application Guides

## Abbreviation Guide

Spheric (S)	Glass (G)
Dome (D)	Plastic (P)
Conic (C)	Metal (M)
Flat (F)	

Application	Recommended Electrodes	Tip Shape	Body Material	Single Reference	Double Reference	Cloth Junction	Ceramic Junction	Open Junction	Viscolene Electrolyte	Gel Electrolyte	KCl 3.5M Electrolyte	KCl 3.5M + AgCl Electrolyte	Refillable	SMART	Temperature Sensor	Amplifier	Pressure (Bar)	Page
Acids, Strong	HI1043(B)(P)	S	G	•	•						•	•					0.1	2.154
	HI10430*	S	G	•	•						•	•	•	•	•	•	0.1	2.161
Alkaline, Strong	HI2111B (half-cell) + HI5311	S	G	•	•						•						0.1	2.171, 2.172
Aquariums	HI1332(B)(P)(D)	S	P	•	•						•	•					0.1	2.160
Bases, Strong	HI1043(B)(P)	S	G	•	•						•	•					0.1	2.154
	HI10430*	S	G	•	•						•	•	•	•	•	•	0.1	2.161
Beer	FC2143	F	M	•	•				•						•	•	3	2.166
	HI1131(B)(P)(Y)	S	G	•	•						•	•					0.1	2.155
	HI11313	S	G	•	•						•	•	•	•	•	•	0.1	2.155
	HI11310*	S	G	•	•						•	•	•	•	•	•	0.1	2.161
	HI11311*	S	G	•	•						•	•	•	•	•	•	0.1	2.161
Biotechnology (< 100 µl)	HI1083(B)(P)	S	G	•				•	•								0.1	2.154
Boilers and Cooling Towers	HI729113	F	M	•			PTFE			Polymer					•	•	3	2.170
Cheese	FC200B/D	C	P	•				•	•								0.1	2.164
	FC2423, FC2423-1	C	M	•			•	•							•	•	0.1	2.167
	FC240B	C	M	•				•	•								0.1	2.165
	FC2023, FC2053	C	P	•				•	•					•	•	•	0.1	2.166
Chemicals	HI1332(B)(P)(D)	S	P	•	•						•	•					0.1	2.160
Conductivity, Low	HI10430*	S	G	•	•						•	•	•	•	•	•	0.1	2.161
	HI1053(B)(P)	C	G	•	•						•	•					0.1	2.154
	HI10530*	C	G	•	•						•	•	•	•	•	•	0.1	2.161
	HI10533	C	G	•	•						•	•	•	•	•	•	0.1	2.154
Conductivity, High	HI1043(B)(P)	S	G	•	•					•	•						0.1	2.154
Creams	FC210B	C	G	•				•	•								0.1	2.164
	FC220B	S	G	•			•				•	•					0.1	2.165
	FC911B	S	P	•	•					•	•				•		0.1	2.166
Dairy (general use)	HI2031B	C	G	•	•						•	•					0.1	2.157
	FC100B	S	P	•	•						•	•					0.1	2.164
	FC1013	S	P	•	•						•	•	•	•	•	•	0.1	2.164
Emulsions	HI1053(B)(P)	C	G	•	•						•	•					0.1	2.154
	HI10530*	C	G	•	•						•	•	•	•	•	•	0.1	2.161
	HI10533	C	G	•	•						•	•	•	•	•	•	0.1	2.154
	HI1413B	F	G	•				•	•								0.1	2.168
	HI14143	F	G	•				•	•						•	•	0.1	2.168
Fats and Creams	HI1053B, HI1053P	C	G	•	•						•	•					0.1	2.154
	HI10530*	C	G	•	•						•	•	•	•	•	•	0.1	2.161
	HI10533	C	G	•	•						•	•	•	•	•	•	0.1	2.154
Flasks	HI1331B	S	G	•	•						•	•					0.1	2.156
Fluoride, Samples with	HI1143B	S	G	•	•						•	•					0.1	2.156
Food Industry (General Use)	FC100B	S	P	•	•						•	•					0.1	2.164
	FC911B	S	P	•	•						•	•					0.1	2.166
Food, Semi-solid	FC2023, FC2053	C	P	•				•	•					•	•	•	0.1	2.166, 2.166
	FC200(B)(D)	C	P	•				•	•								0.1	2.164

\*edge® specific electrode



### Abbreviation Guide

Spheric (S)	Glass (G)
Dome (D)	Plastic (P)
Conic (C)	Metal (M)
Flat (F)	

Tip Shape	Body Material	Single Reference	Double Reference	Cloth Junction	Ceramic Junction	Open Junction	Viscolene Electrolyte	Gel Electrolyte	KCl 3.5M Electrolyte	KCl 3.5M + AgCl Electrolyte	Refillable	SMART	Temperature Sensor	Amplifier	Pressure (Bar)
-----------	---------------	------------------	------------------	----------------	------------------	---------------	-----------------------	-----------------	----------------------	-----------------------------	------------	-------	--------------------	-----------	----------------

Application	Recommended Electrodes	Tip Shape	Body Material	Single Reference	Double Reference	Cloth Junction	Ceramic Junction	Open Junction	Viscolene Electrolyte	Gel Electrolyte	KCl 3.5M Electrolyte	KCl 3.5M + AgCl Electrolyte	Refillable	SMART	Temperature Sensor	Amplifier	Pressure (Bar)	Page
Fruits	FC200(B)(D)	C	P	•				•		•							0.1	2.164
	FC2023, FC2053	C	P		•			•	•					•	•	•	0.1	2.166, 2.166
Fruit Juices, Organic	FC220B	S	G	•			•				•	•					0.1	2.165
	FC911B	S	P		•		•				•		•			•	0.1	2.166
Frozen, Semi	FC230B	C	P	•				•	•								0.1	2.165
Ham and Sausages	FC200(B)(D)	C	P	•				•		•							0.1	2.164
	FC2023, FC2053	C	P		•			•	•					•	•	•	0.1	2.166
	FC230B	C	P	•				•	•								0.1	2.165
Humidity, High	FC911B	S	P		•		•				•	•				•	0.1	2.166
Hydrocarbons	HI1043(B)(P)	S	G		•		•				•		•				0.1	2.154
	HI10430*	S	G		•		•				•		•	•	•	•	0.1	2.161
Laboratory (General Use)	HI1131(B)(P)(Y)	S	G		•		•				•		•				0.1	2.155
	HI11313	S	G		•		•				•		•	•	•	•	0.1	2.155
	HI1230(B)(Y)	S	P		•		•			•							2	2.156
	HI12303	S	P		•		•			•			•	•	•	•	2	2.156
	HI1217-1, HI1291D	S	P	•			•			•					•	•	2	2.159, 2.159
	HI11310*	S	G		•		•				•		•	•	•	•	0.1	2.161
	HI11311*	S	G		•		•				•		•	•	•	•	0.1	2.161
	HI12300*	S	P		•		•			•			•	•	•	•	2	2.163
	HI12301*	S	P		•		•			•			•	•	•	•	2	2.163
	HI1110B	S	G	•			•			•							0.1	2.156
HI11103	S	G	•			•			•				•	•	•	0.1	2.156	
Leather	HI1413B	F	G	•				•	•								0.1	2.168
	HI14143	F	G	•				•	•						•	•	0.1	2.168
Meats	FC230B	C	P	•				•	•								0.1	2.165
	FC400B	C	P		•			•	•								0.1	2.165
	FC2323	C	P	•				•	•						•	•	0.1	2.167
	FC2023, FC2053	C	P		•			•	•					•	•	•	0.1	2.166, 2.166
	FC2320*	C	P	•				•	•					•	•	•	0.1	2.162
Milk	FC100B	S	P		•		•				•	•					0.1	2.164
	FC1013	S	P		•		•				•	•			•	•	0.1	2.164
	FC260B (half-cell)	S	G															2.171
Monitoring, Continuous	HI1135B	S	G		•		•				•	•					3	2.155
Must in Winemaking	HI1048(B)(P)(Y), HI1048B/50	D	G		•			•			•	•					0.1	2.166
	FC10483	D	G		•			•			•	•			•	•	0.1	2.166
	HI10480*	D	G		•			•			•	•	•	•	•	•	0.1	2.162
NMR Tubes	HI1093(B)(P)	S	G	•			•	•									0.1	2.155
Paints	HI1043(B)(P)	S	G		•		•				•	•					0.1	2.154
	HI10430*	S	G		•		•				•	•	•	•	•	•	0.1	2.161
Paper	HI1413B	F	G	•				•	•								0.1	2.168
	HI14143	F	G	•				•	•						•	•	0.1	2.168
Photographic Chemicals	HI1230(B)(Y)	S	P		•		•			•				•	•	•	2	2.156
	HI12303	S	P		•		•			•				•	•	•	2	2.156
Plating Baths	HI629113	F	M				PTFE			Polymer							3	2.170
Quality Control	HI1332(B)(P)(D)	S	P		•		•				•	•					0.1	2.160
	FC240B	C	M	•				•		•							0.1	2.165

\*edge® specific electrode

## pH Electrode Application Guides

Spheric (S)  
Dome (D)  
Conic (C)  
Flat (F)

Glass (G)  
Plastic (P)  
Metal (M)

Application	Recommended Electrodes	Tip Shape	Body Material	Single Reference	Double Reference	Cloth Junction	Ceramic Junction	Open Junction	Viscolene Electrolyte	Gel Electrolyte	KCl 3.5M Electrolyte	KCl 3.5M + AgCl Electrolyte	Refillable	SMART	Temperature Sensor	Amplifier	Pressure (Bar)	Page
Sauces	FC220B	S	G	•			•				•	•					0.1	2.165
	FC911B	S	P		•		•				•	•					0.1	2.166
Seawater	HI1043(B)(P)	S	G		•		•				•	•					0.1	2.154
	HI10430*	S	G		•		•				•	•	•	•	•	•	0.1	2.161
Semi-solid Products	HI1053(B)(P)	C	G		•		•				•	•					0.1	2.154
	HI10530*	C	G		•		•				•	•	•	•	•	•	0.1	2.161
	HI10533	C	G		•		•				•	•	•	•	•	•	0.1	2.154
	FC200(B)(D)	C	P	•				•	•								0.1	2.164
	HI2031B	C	G		•		•				•	•					0.1	2.157
Skin, Scalp	HI1413B	F	G					•	•								0.1	2.168
	HI14143/50	F	G					•	•						•	•	0.1	2.168
Soil, Direct	HI12923	C	G		•		•				•	•			•	•	0.1	2.168
	HI12943**	C	G		•		•				•	•			•	•	0.1	2.169
Soil Solution	HI1053(B)(P)	C	G		•		•				•	•					0.1	2.154
	HI10530*	C	G		•		•				•	•	•	•	•	•	0.1	2.161
	HI10533	C	G		•		•				•	•	•	•	•	•	0.1	2.154
	HI1230(B)(Y)	S	P		•		•		•								2	2.156
	HI12923	C	G		•		•				•	•			•	•	0.1	2.168
	HI12943**	C	G		•		•				•	•			•	•	0.1	2.169
Solvents	HI1043(B)(P)	S	G		•		•				•	•					0.1	2.154
	HI10430*	S	G		•		•				•	•	•	•	•	•	0.1	2.161
Surface Measurements	HI1413B	F	G					•	•								0.1	2.168
	HI14143	F	G					•	•						•	•	0.1	2.168
	HI14140*	F	G					•	•					•	•	•	0.1	2.162
Swimming Pools	HI12973	C	M			•			•					•	•	3	2.169	
Titrations, Non Aqueous	HI1049B	D	G		•			•			•	•					0.1	2.168
	HI1151B	S	G		•		•				•	•					0.1	2.155
Tris Buffer	HI1043(B)(P)	S	G		•		•				•	•					0.1	2.154
	HI10430*	S	G		•		•				•	•	•	•	•	•	0.1	2.161
	HI1144B	S	G		•		•				•	•					0.1	2.157
	HI1343B	S	P		•		•				•	•					0.1	2.157
Vials and Test Tubes	HI1330(B)(P)	S	G		•		•				•	•					0.1	2.157
Wastewater	HI12963	S	M		•		•				•	•			•	•	3	2.169
	HI12973	C	M		•		•			•					•	•	3	2.169
Water, High Purity	HI1053B, HI1053P	C	G		•		•				•	•					0.1	2.154
	HI10530*	C	G		•		•				•	•	•	•	•	•	0.1	2.161
	HI10533	C	G		•		•				•	•	•	•	•	•	0.1	2.154
Water, Municipal	HI12973	C	M		•		•			•				•	•	3	2.169	
Water, Potable	HI1053(B)(P)	C	G		•		•				•	•					0.1	2.154
	HI10530*	C	G		•		•				•	•	•	•	•	•	0.1	2.161
	HI10533	C	G		•		•				•	•	•	•	•	•	0.1	2.154
	FC2153	S	G		•		•				•	•			•	•	0.1	2.169
Water Treatment	HI12973	C	M		•		•			•				•	•	3	2.169	
Yogurt	FC200(B)(D)	C	P		•			•	•								0.1	2.164
	FC210B	C	G		•			•	•								0.1	2.164
	FC2133	C	G		•			•	•						•	•	0.1	2.167
	FC2023, FC2053	C	P		•			•	•					•	•	•	0.1	2.166. 2.166
	FC2100*	C	G		•			•	•					•	•	•	0.1	2.162
	FC2020*	C	P		•			•	•					•	•	•	0.1	2.162

\*edge® specific electrode; \*\*HI9814 GroLine® portable meter specific electrode

# ORP Electrode Application Guides

## Abbreviation Guide

Platinum (Pt)  
Gold (Au)

Glass (G)  
Plastic (P)

Application	Recommended Electrodes	Sensor	Body Material	Single Reference	Double Reference	Cloth Junction	Ceramic Junction	Open Junction	Gel Electrolyte	KCl 3.5M Electrolyte	KCl 3.5M + AgCl Electrolyte	Refillable	SMART	Temperature Sensor	Amplifier	Pressure (Bar)	Page
Field	HI36203	Pt	P	•			•		•							2	2.160
Laboratory (General Use)	HI3131B	Pt	G	•			•				•	•				0.1	2.158
	HI3618D, HI36183	Pt	G	•			•				•	•		•	•	0.1	2.158
	HI36180*	Pt	G		•		•				•	•	•	•	•	0.1	2.163
	HI36200*	Pt	P	•			•		•				•	•	•	2	2.163
Must in Winemaking	HI3149B	Pt	G		•			•		•						0.1	2.158
Oxidants	HI4430B	Au	P	•			•		•							2	2.160
Ozone	HI4430B	Au	P	•			•		•							2	2.160
Quality Control	HI3230B	Pt	P	•			•		•							2	2.160
Titration, ORP	HI3131B	Pt	G	•			•				•	•				0.1	2.158
Water, Municipal	HI3230B	Pt	P	•			•		•							2	2.160
Must in Winemaking	HI3148B	Pt	G		•			•		•			•			0.1	2.167

\*edge® specific electrode

# Half-Cell and Reference Electrode Application Guides

## Abbreviation Guide

Spheric (S)  
Cylindric (C)  
Platinum (Pt)  
Gold (Au)

Glass (G)  
Plastic (P)

Application	Recommended Electrodes	pH Half Cell	ORP Half Cell	Reference	Tip Shape	Body Material	Single Reference	Double Reference	PE Sleeve Junction	Ceramic Junction	KCl 3.5M Electrolyte	Pressure (Bar)	Page
Laboratory (General Use)	HI2111B			•		S	G						2.171
	HI2112B			•		S	P						2.171
	HI3133B		•			Pt	G						2.171
	HI5412			•		G	•			•	•	0.1	2.172
Milk	HI5311			•		G		•		•	•	0.1	2.172
	FC260B		•			S	G						2.171
Remote Filling	HI5314			•		G		•		•	•	3	2.172
	HI5414			•		G	•			•	•	3	2.172
Strong Alkaline Solutions	HI2111B			•		S	G						2.171
Suspended Solids	HI5413			•		G	•		•	•	•	0.1	2.173
	HI5312			•		G		•	•	•	•	0.1	2.173
	HI5313			•		P	•			•		0.1	2.173
Titration, Argentometric	HI5110B			•		C	G						2.171
Titrations, General	HI5412			•		G	•			•	•	0.1	2.172
	HI5311			•		G		•		•	•	0.1	2.172
	HI5312			•		G		•	•	•	•	0.1	2.173
Titration, Potentiometric	HI5313			•		P	•			•		0.1	2.173
	HI3133B		•			Pt	G						2.171



Code	HI1043[ ]	HI1053[ ]	HI10533	HI1083[ ]
Description	refillable, combination pH electrode w/ double junction	refillable, combination pH electrode w/ conical tip	refillable, combination pH electrode w/ conical tip	combination pH electrode w/micro bulb for small samples
Reference	double, Ag/AgCl	double, Ag/AgCl	double, Ag/AgCl	double, Ag/AgCl
Junction / Flow Rate	ceramic, double / 30-40 µL/h	ceramic, triple / 40-50 µL/h	ceramic, triple / 40-50 µL/h	open
Electrolyte	KCl 3.5M	KCl 3.5M	KCl 3.5M	viscolene
Max Pressure	0.1 bar	0.1 bar	0.1 bar	0.1 bar
Range	pH: 0 to 14	pH: 0 to 12	pH: 0 to 12	pH: 0 to 12
Recommended Operating Temp.	0 to 100°C (32 to 212°F)	-5 to 70°C (23 to 158°F)	-5 to 70°C (23 to 158°F)	0 to 50°C (32 to 122°F)
Glass Type	HT (high temperature)	LT (low temperature)	LT (low temperature)	GP (general purpose)
Tip/Shape	spheric (dia: 9.5 mm)	conic (12 x 12 mm)	conic (12 x 12 mm)	spheric (dia: 3 mm)
Temperature Sensor	no	no	yes	no
Amplifier	no	no	yes	no
Body Material	glass - HT	glass - LT	glass - LT	glass - GP
Cable	coaxial; 1 m (3.3')	coaxial; 1 m (3.3')	coaxial; 1 m (3.3')	coaxial; 1 m (3.3')
Recommended Use	hydrocarbons, paints, solvents, sea water, strong acids and bases, high conductivity samples, tris buffer	fats and creams, high purity water, soil samples, potable water, semi-solid products, low conductivity solutions, emulsions	fats and creams, high purity water, soil samples, potable water, semi-solid products, low conductivity solutions, emulsions	biotechnology, samples < 100 µL
Connection	<b>HI1043B</b> BNC <b>HI1043P</b> BNC + pin*	<b>HI1053B</b> BNC <b>HI1053P</b> BNC + pin*	<b>HI10533</b> Quick Connect DIN	<b>HI1083B</b> BNC <b>HI1083P</b> BNC + pin*

\* For pH meters with CAL Check™ system

\* For pH meters with CAL Check system

\* For pH meters with CAL Check system



Code	HI1093B	HI1131[ ]	HI1151B	HI1135B
Description	combination pH electrode w/ extended length and micro bulb	refillable, combination pH electrode	refillable, combination pH electrode	refillable, combination pH electrode w/ side arm construction and fast flow rate
Reference	single, Ag/AgCl	double, Ag/AgCl	double, Ag/AgCl	double, Ag/AgCl
Junction / Flow Rate	open	ceramic, single / 15-20 µL/h	ceramic, single / 15-20 µL/h	ceramic, double / 30-40 µL/h
Electrolyte	viscolene	KCl 3.5M	-	KCl 3.5M
Max Pressure	0.1 bar	0.1 bar	0.1 bar	3 bar with back pressure
Range	pH: 0 to 14	pH: 0 to 14	pH: 0 to 13	pH: 0 to 14
Recommended Operating Temp.	0 to 50°C (32 to 122°F)	0 to 100°C (32 to 212°F)	0 to 100°C (32 to 212°F)	0 to 100°C (32 to 212°F)
Glass Type	GP (general purpose)	HT (high temperature)	HT (high temperature)	HT (high temperature)
Tip /Shape	spheric (dia: 3 mm)	spheric (dia: 9.5 mm)	spheric (dia: 9.5 mm)	spheric (dia: 9.5 mm)
Temperature Sensor	no	DIN and BNC + RCA model only	no	no
Amplifier	no	DIN model only	no	no
Body Material	glass - GP	glass	glass	glass
Cable	coaxial; 1 m (3.3')	coaxial; 1 m (3.3')	coaxial; 1 m (3.3')	coaxial; 1 m (3.3')
Recommended Use	NMR tubes	laboratory general purpose, beer	non-aqueous titration	continuous monitoring with remote filling
Connection	<b>HI1093B</b> BNC <b>HI1093P</b> BNC + pin*	<b>HI1131B</b> BNC <b>HI1131P</b> BNC + pin* <b>HI11313</b> Quick Connect DIN <b>HI1131Y</b> BNC + RCA***	<b>HI1151B</b> BNC	<b>HI1135B</b> BNC

\* For pH meters with CAL Check™ system

\* For pH meters with CAL Check™ system  
\*\*\* Thermistor with RCA connector

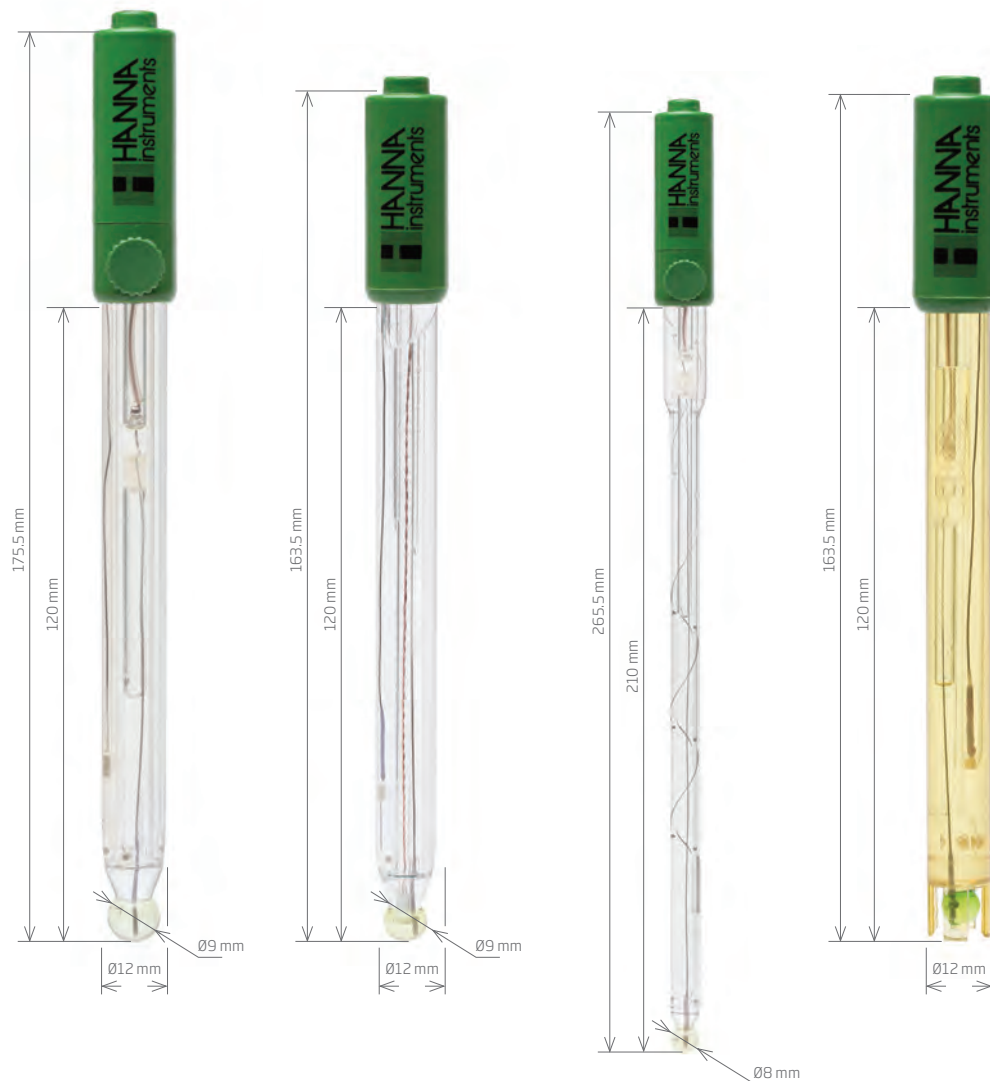

Code	HI1143B	HI1110 [ ]	HI1331B	HI1230 [ ]
Description	refillable, combination pH electrode for fluoride applications	combination pH electrode	combination pH electrode	combination pH electrode
Reference	double, Ag/AgCl	single, Ag/AgCl	single, Ag/AgCl	double, Ag/AgCl
Junction / Flow Rate	ceramic, single / 15-20 µL/h	ceramic, single / 15-20 µL/h	ceramic, single / 15-20 µL/h	ceramic, single / 15-20 µL/h
Electrolyte	KCl 3.5M	gel	KCl 3.5M + AgCl	gel
Max Pressure	0.1 bar	0.1 bar	0.1 bar	2 bar
Range	pH: 0 to 10	pH: 0 to 13	pH: 0 to 13	pH: 0 to 12
Recommended Operating Temp.	-5 to 60°C (23 to 140°F) – HF	0 to 80°C (32 to 176°F) – GP	0 to 70°C (32 to 158°F) – GP	-5 to 70°C (23 to 158°F) – LT
Glass Type	HF (hydrofluoric acid resistant)	GP (general purpose)	GP (general purpose)	LT (low temperature)
Tip/Shape	spheric (dia: 9.5 mm)	spheric (dia: 9.5 mm)	spheric (dia: 7.5 mm)	spheric (dia: 7.5 mm)
Temperature Sensor	no	DIN model only	no	DIN and BNC + RCA model only
Amplifier	no	DIN model only	no	DIN model only
Body Material	glass	glass	glass	PEI
Cable	coaxial; 1 m (3.3')	coaxial; 1 m (3.3')	coaxial; 1 m (3.3')	coaxial; 1 m (3.3')
Recommended Use	samples with fluoride (max 2 g/L @ pH 2 and temperature < 60°C)	general purpose	specific for flasks	field applications, soil solution, photographic chemicals, laboratory (general use)
Connection	<b>HI1143B</b> BNC	<b>HI1110B</b> BNC <b>HI11103</b> Quick Connect DIN	<b>HI1331B</b> BNC	<b>HI1230B</b> BNC <b>HI12303</b> Quick Connect DIN <b>HI1230Y</b> BNC + RCA***

\*\*\* Thermistor with RCA connector



pH

electrodes

Code	HI1144B	HI1330[ ]	HI1343B	HI2031B
Description	refillable, combination pH electrode with calomel references	refillable, combination pH electrode	combination pH electrode	refillable, conical tip combination pH electrode
Reference	single, Hg/Hg <sub>2</sub> Cl <sub>2</sub>	single, Ag/AgCl	single, Hg/Hg <sub>2</sub> Cl <sub>2</sub>	single, Ag/AgCl
Junction / Flow Rate	ceramic / 15-20 µL/h	ceramic, single / 15-20 µL/h	ceramic, single / 15-20 µL/h	ceramic, single / 15-20 µL/h
Electrolyte	KCl 3.5M	KCl 3.5M + AgCl	KCl 3.5M	KCl 3.5M + AgCl
Max Pressure	0.1 bar	0.1 bar	0.1 bar	0.1 bar
Range	pH: 0 to 14	pH: 0 to 12	pH: 0 to 14	pH: 0 to 12
Recommended Operating Temp.	0 to 60°C (32 to 140°F) - HT	-5 to 70°C (23 to 158°F) - LT	0 to 60°C (32 to 140°F) - HT	-5 to 70°C (23 to 158°F) - LT
Glass Type	HT (high temperature)	LT (low temperature)	HT (high temperature)	LT (low temperature)
Tip / Shape	spheric (dia: 9.5 mm)	spheric (dia: 5 mm)	spheric (dia: 7.5 mm)	conic (6 x 10 mm)
Temperature Sensor	no	no	no	no
Amplifier	no	no	no	no
Body Material	glass	glass	PEI	glass
Cable	coaxial; 1 m (3.3')	coaxial; 1 m (3.3')	coaxial; 1 m (3.3')	coaxial; 1 m (3.3')
Recommended Use	tris buffer	specific for vials and test tubes	specific for Tris buffer	dairy and semi-solid products
Connection	<b>HI1144B</b> BNC	<b>HI1330B</b> BNC <b>HI1330P</b> BNC + pin*	<b>HI1343B</b> BNC	<b>HI2031B</b> BNC

\* For pH meters with CAL Check™ system



## pH Electrode Protective Sleeves

The Hanna pH electrode protective sleeve helps to prevent accidental damage to the glass bulb from stirrers, accidentally dropping electrodes into a beaker/vessel, and general field use. Designed to be used with Hanna 12 mm DIA glass spherical and conical tip electrodes including the 12 mm electrodes on certain HALO®, HALO2 and HI9810XX models. This sleeve also works with 12 mm DIA half cells, reference electrodes and FC300B ISE. Please make sure the probe junction is not obscured by the sleeve when taking measurements. Not for short or long term storage: Please remove the protective sleeve and use the cap originally supplied with your electrode filled with the appropriate amount of storage solution when storing.

- Ideal for electrode protection out in the field
- Helps protect the electrode against accidental drops and strikes
- Allows electrode protection without interfering with measurements

Code	HI3131B	HI3149B	HI3618D/HI36183
Description	refillable combination ORP electrode	ORP electrode	ORP combination electrode
Reference	single, Ag/AgCl	double, Ag/AgCl	single, Ag/AgCl
Junction / Flow Rate	ceramic, single / 15-20 µL/h	CPS™	ceramic, single / 15-20 µL/h
Electrolyte	KCl 3.5M + AgCl	KCl 3.5M	KCl 3.5M + AgCl
Max Pressure	0.1 bar	0.1 bar	0.1 bar
Range	ORP: ±2000 mV	ORP: ±2000 mV	ORP: ±2000 mV
Recommended Operating Temp.	-5 to 70°C (23 to 158°F)	-5 to 60°C (23 to 140°F)	-5 to 70°C (23 to 158°F)
Glass Type	-	-	-
Tip/Shape	platinum pin	platinum ring	platinum pin
Temperature Sensor	no	no	yes
Amplifier	no	no	yes
Body Material	glass	glass	glass
Cable	coaxial; 1 m (3.3')	coaxial; 1 m (3.3')	5-pole; 1 m (3.3')
Recommended Use	laboratory general use, ORP titrations	non-aqueous titrations	laboratory
Connection	<b>HI3131B</b> BNC	<b>HI3149B</b> BNC	<b>HI36183</b> Quick Connect DIN <b>HI3618D-1</b> DIN**

\*\* Recommended for use with HI8314-1 pH meter

### Specifications

<b>Length</b>	40 mm
<b>Material</b>	PEI

### Ordering Information

**HI740244** Green pH electrode protective sleeve (3 pcs).  
**HI740245** White pH electrode protective sleeve (3 pcs).





Code	HI1217-1	HI1291D
Description	pH electrode	pH electrode
Reference	single, Ag/AgCl	single, Ag/AgCl
Junction / Flow Rate	ceramic, single	ceramic, single
Electrolyte	gel	gel
Max Pressure	2 bar	2 bar
Range	pH: 0 to 13	pH: 0 to 12
Recommended Operating Temp.	0 to 70°C (32 to 158°F)	0 to 70°C (32 to 158°F)
Glass Type	GP (general purpose)	GP (general purpose)
Tip / Shape	spheric (dia: 5.0 mm)	spheric (dia: 5.0 mm)
Temperature Sensor	yes	yes
Amplifier	yes	yes
Body Material	PEI	PEI
Cable	coaxial; 1 m (3.3')	coaxial; 1 m (3.3')
Recommended Use	general purpose	general purpose, education, laboratory
Connection	<b>HI1217-1</b> DIN**	<b>HI1291D</b> DIN**

\*\* Recommended for use with HI8314-1 pH meter

\*\* Recommended for use with HI207 and HI208 pH meters

## Tips for the Most Accurate Measurements

### Keep Electrode Hydrated

Ideally, pH electrodes should be kept in a storage solution when not in use. Placing the electrode in a small glass filled with storage solution is suitable. An option for pocket meters is to place a small piece of sponge into the meter's cap and pour storage solution into the cap to wet the sponge. Pouring off any excess solution beforehand, the cap can then be placed on the meter.

If a storage solution is not available the next best option is to use pH 4.01 buffer (pH 7.01 is also suitable to a lesser extent).

### Clean Electrodes Before Use

Clean the junction of your electrodes once a day or at least once a week to prevent junction clogging and to maintain accuracy. Immerse the electrode in the proper cleaning solution for at least 15 to 20 minutes. Hanna offers a wide range of cleaning solutions for general purpose and specific applications.

### Replace Electrodes Once a Year

If your electrode takes too long to stabilize a reading, or readings fluctuate wildly, it is most likely time to replace the electrode. The typical life span of any pH electrode is from 6 months to 1.5 years.

### Additional Tips

- Calibration and storage solutions should be changed regularly (i.e. monthly).
- Calibrate the meter often if a high degree of accuracy is required.
- Remember that the calibration is as only as good the buffer being used (i.e. old or contaminated buffer may not have the same value on the label).
- Single-use calibration sachets, as opposed to bottles, ensure that your buffer solution is always fresh.
- If the meter takes an unusually long time to get a stable reading, the junction may be clogged.
- Rinse the probe with purified water after each use.

# 2 Rugged pH and ORP Electrodes

pH

electrodes



Code	HI1332[ ]	HI3230B	HI36203	HI4430B
Description	pH electrode	gel-filled, combination ORP electrode w/ platinum contact	ORP probe	gel-filled, combination ORP electrode w/ gold contact
Reference	double, Ag/AgCl	single, Ag/AgCl	single, Ag/AgCl	single, Ag/AgCl
Junction / Flow Rate	ceramic, single / 15-20 µL/h	ceramic, single	ceramic, single	ceramic, single
Electrolyte	KCl 3.5M	gel	gel	gel
Max Pressure	0.1 bar	2 bar	2 bar	2 bar
Range	pH: 0 to 13	ORP: ±2000 mV	ORP: ±2000 mV	ORP: ±2000 mV
Recommended Operating Temp.	0 to 70°C (32 to 158°F) - GP	-5 to 70°C (23 to 158°F)	-5 to 70°C (23 to 158°F)	-5 to 70°C (23 to 158°F)
Glass type	GP (general purpose)	-	-	-
Tip /Shape	spheric (dia: 7.5 mm)	platinum pin	platinum pin	gold pin
Temperature Sensor	no	no	yes	no
Amplifier	no	no	yes	no
Body Material	PEI	PEI	PEI	PEI
Cable	coaxial; 1 m (3.3')	coaxial; 1 m (3.3')	coaxial; 1 m (3.3')	coaxial; 1 m (3.3')
Recommended Use	chemicals, field applications, quality control, aquariums	municipal water, quality control	field applications	oxidants, ozone
Connection	<b>HI1332B</b> BNC <b>HI1332P</b> BNC + pin* <b>HI1332D</b> DIN	<b>HI3230B</b> BNC	<b>HI36203</b> Quick Connect DIN	<b>HI4430B</b> BNC

\* For pH meters with CAL Check™ system

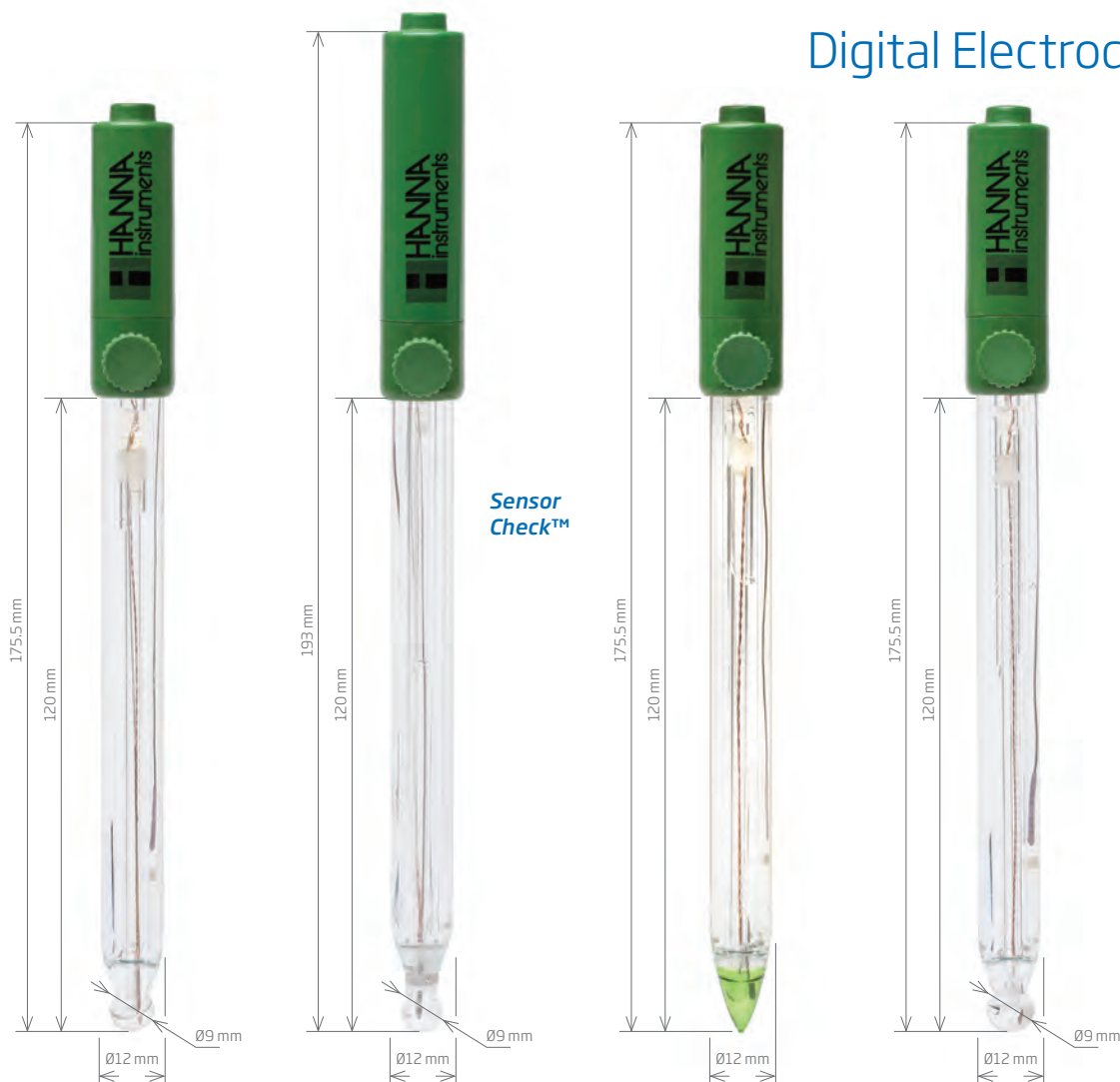

pH

electrodes

Code	HI11310	HI11311	HI10530	HI10430
Description	refillable, combination, digital pH electrode	refillable, combination, digital pH electrode w/ Sensor Check™	refillable, combination, digital pH electrode with conical tip	refillable, combination, digital pH electrode with double junction
Reference	double, Ag/AgCl	double, Ag/AgCl	double, Ag/AgCl	double, Ag/AgCl
Junction	ceramic, single / 15-20 µL/h	ceramic, single / 15-20 µL/h	ceramic, triple / 40-50 µL/h	ceramic, triple / 40-50 µL/h
Electrolyte	KCl 3.5M	KCl 3.5M	KCl 3.5M	KCl 3.5M
Max Pressure	0.1 bar	0.1 bar	0.1 bar	0.1 bar
Range	pH: 0 to 14	pH: 0 to 14	pH: 0 to 12	pH: 0 to 13
Recommended Operating Temp.	0 to 100°C (32 to 212°F)	0 to 100°C (32 to 212°F)	-5 to 70°C (23 to 158°F)	0 to 100°C (32 to 212°F)
Glass Type	HT (high temperature)	HT (high temperature)	LT (low temperature)	HT (high temperature)
Tip /Shape	spheric (dia: 9.5 mm)	spheric (dia: 9.5 mm)	conic (12 x 12 mm)	spheric (dia: 9.5 mm)
Temperature Sensor	yes	yes	yes	yes
Matching Pin	no	yes	no	no
Amplifier	yes	yes	yes	yes
Body Material	glass	glass	glass	glass
Cable	1 m (3.3')	1 m (3.3')	1 m (3.3')	1 m (3.3')
Recommended Use	laboratory general purpose, beer	laboratory general purpose, beer	fats and creams, high purity water, soil samples, potable water, semi-solid products, low conductivity solutions, emulsions	hydrocarbons, paints, solvents, sea water, strong acids and bases, high conductivity samples, tris buffer
Connection	<b>HI11310</b> 3.5 mm connector	<b>HI11311</b> 3.5 mm connector	<b>HI10530</b> 3.5 mm connector	<b>HI10430</b> 3.5 mm connector

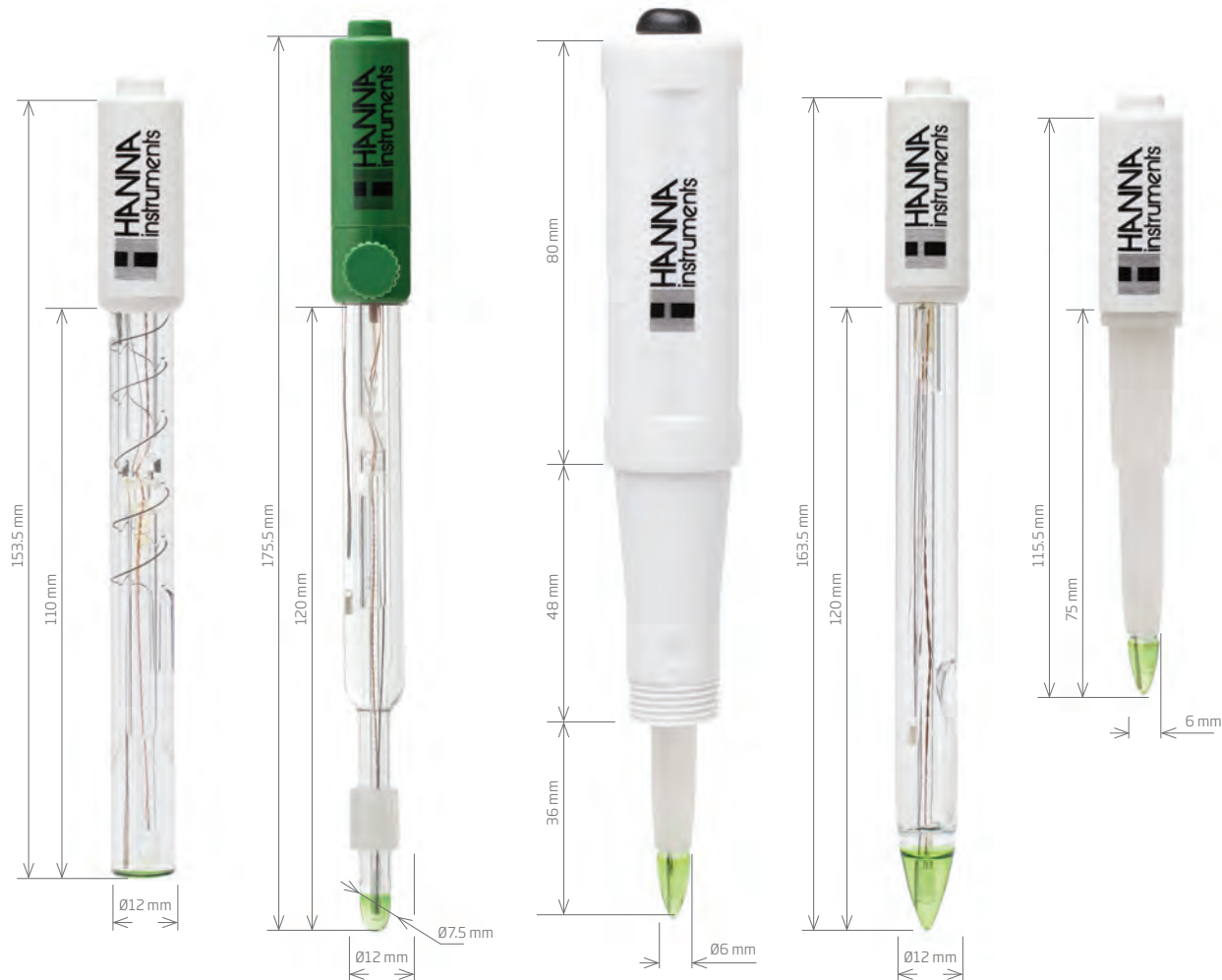

Code	HI14140	HI10480	FC2320	FC2100	FC2020
Description	digital pH electrode	refillable, digital pH electrode w/ CPS™ (clogging prevention system)	digital pH electrode	digital pH electrode	digital pH Electrode
Reference	single, Ag/AgCl	double, Ag/AgCl	double, Ag/AgCl	double, Ag/AgCl	double, Ag/AgCl
Junction	open	CPS™	open	open	open
Electrolyte	viscolene	KCl 3.5M	viscolene	viscolene	viscolene
Max Pressure	0.1 bar	0.1 bar	0.1 bar	0.1 bar	0.1 bar
Range	pH: 0 to 12	pH: 0 to 12	pH: 0 to 12	pH: 0 to 12	pH: 0 to 12
Recommended Operating Temp.	0 to 50°C (32 to 122°F)	-5 to 60°C (23 to 140°F)	0 to 60°C (32 to 140°F)	0 to 60°C (32 to 140°F)	0 to 60°C (32 to 140°F)
Glass Type	LT (low temperature)	LT (low temperature)	LT (low temperature)	LT (low temperature)	LT (low temperature)
Tip /Shape	flat	dome (dia: 8 mm)	conic (6 x 10 mm)	conic (12 x 12 mm)	conic (6 x 10 mm)
Temperature Sensor	yes	yes	yes	yes	yes
Matching Pin	no	no	no	no	no
Amplifier	yes	yes	yes	yes	yes
Body Material	glass	glass	PVDF	glass	PVDF
Cable	1 m (3.3')	1 m (3.3')	1 m (3.3')	1 m (3.3')	1 m (3.3')
Recommended Use	surfaces	application specific purpose, must in winemaking	application specific purpose, meat	application specific purpose, yogurt	application specific purpose, yogurt, cheese
Connection	<b>HI14140</b> 3.5 mm connector	<b>HI10480</b> 3.5 mm connector	<b>FC2320</b> 3.5 mm connector	<b>FC2100</b> 3.5 mm connector	<b>FC2020</b> 3.5 mm connector

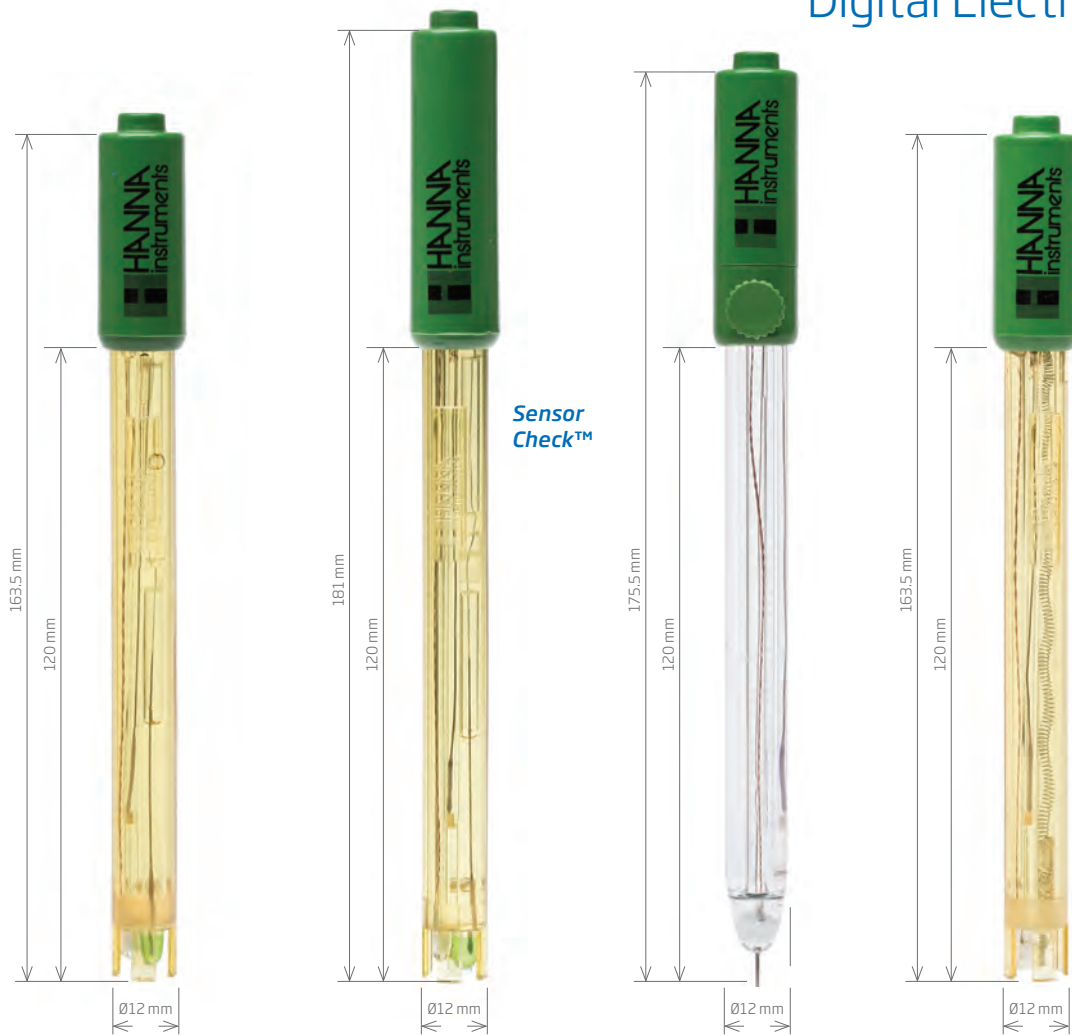

pH

electrodes

Code	HI12300	HI12301	HI36180	HI36200
Description	combination, digital pH electrode	combination, digital pH electrode	refillable, ORP digital probe	ORP digital probe
Reference	double, Ag/AgCl	double, Ag/AgCl	double, Ag/AgCl	single, Ag/AgCl
Junction / Flow Rate	ceramic, single / 15-20 µL/h	ceramic, single / 15-20 µL/h	ceramic, single / 15-20 µL/h	ceramic, single
Electrolyte	gel	gel	KCl 3.5M + AgCl	gel
Max Pressure	2 bar	2 bar	0.1 bar	2 bar
Range	pH: 0 to 12	pH: 0 to 12	ORP: ±2000 mV	ORP: ±2000 mV
Recommended Operating Temp.	-5 to 70°C (23 to 158°F)	-5 to 70°C (23 to 158°F)	-5 to 100°C (23 to 212°F)	-5 to 70°C (23 to 158°F)
Glass Type	LT (low temperature)	LT (low temperature)	-	-
Tip /Shape	spheric (dia: 7.5 mm)	spheric (dia: 7.5 mm)	platinum pin	platinum pin
Temperature Sensor	yes	yes	yes	yes
Matching Pin	no	yes	no	no
Amplifier	yes	yes	yes	yes
Body Material	PEI	PEI	glass	PEI
Cable	1 m (3.3')	1 m (3.3')	1 m (3.3')	1 m (3.3')
Recommended Use	field applications	field applications	laboratory general purpose	field applications
Connection	<b>HI12300</b> 3.5 mm connector	<b>HI12301</b> 3.5 mm connector	<b>HI36180</b> 3.5 mm connector	<b>HI36200</b> 3.5 mm connector

# 2 Electrodes for the Food Industry

pH

electrodes



Code	FC100B	FC1013	FC200[ ]	FC210B
Description	pH electrode	preamplified pH/temperature probe	pH electrode	pH electrode
Reference	double, Ag/AgCl	double, Ag/AgCl	single, Ag/AgCl	double, Ag/AgCl
Junction / Flow Rate	ceramic, single / 15-20 µL/h	ceramic, single / 15-20 µL/h	open	open
Electrolyte	KCl 3.5M	KCl 3.5M	viscolene	viscolene
Max Pressure	0.1 bar	0.1 bar	0.1 bar	0.1 bar
Range	pH: 0 to 13	pH: 0 to 13	pH: 0 to 12	pH: 0 to 12
Recommended Operating Temp.	0 to 70°C (32 to 158°F)	0 to 70°C (32 to 158°F)	0 to 50°C (32 to 122°F)	0 to 60°C (32 to 140°F)
Glass Type	GP (general purpose)	GP (general purpose)	LT (low temperature)	LT (low temperature)
Tip /Shape	spheric (dia: 7.5 mm)	spheric (dia: 7.5 mm)	conic (6 x 10 mm)	conic (12 x 12 mm)
Temperature Sensor	no	yes	no	no
Amplifier	no	yes	no	no
Body Material	PVDF	PVDF	PVDF	glass
Cable	coaxial; 1 m (3.3')	coaxial; 1 m (3.3')	coaxial; 1 m (3.3')	coaxial; 1 m (3.3')
Recommended Use	food industry (general use), milk	food industry (general use), milk	penetration, yogurt, cheese, semi-solid foods, fruits, ham and sausages	yogurt, creams
Connection	<b>FC100B</b> BNC	<b>FC1013</b> Quick Connect DIN*	<b>FC200B</b> BNC <b>FC200D</b> DIN	<b>FC210B</b> BNC

\* Recommended for use with HI98162 and HI99162 pH meters

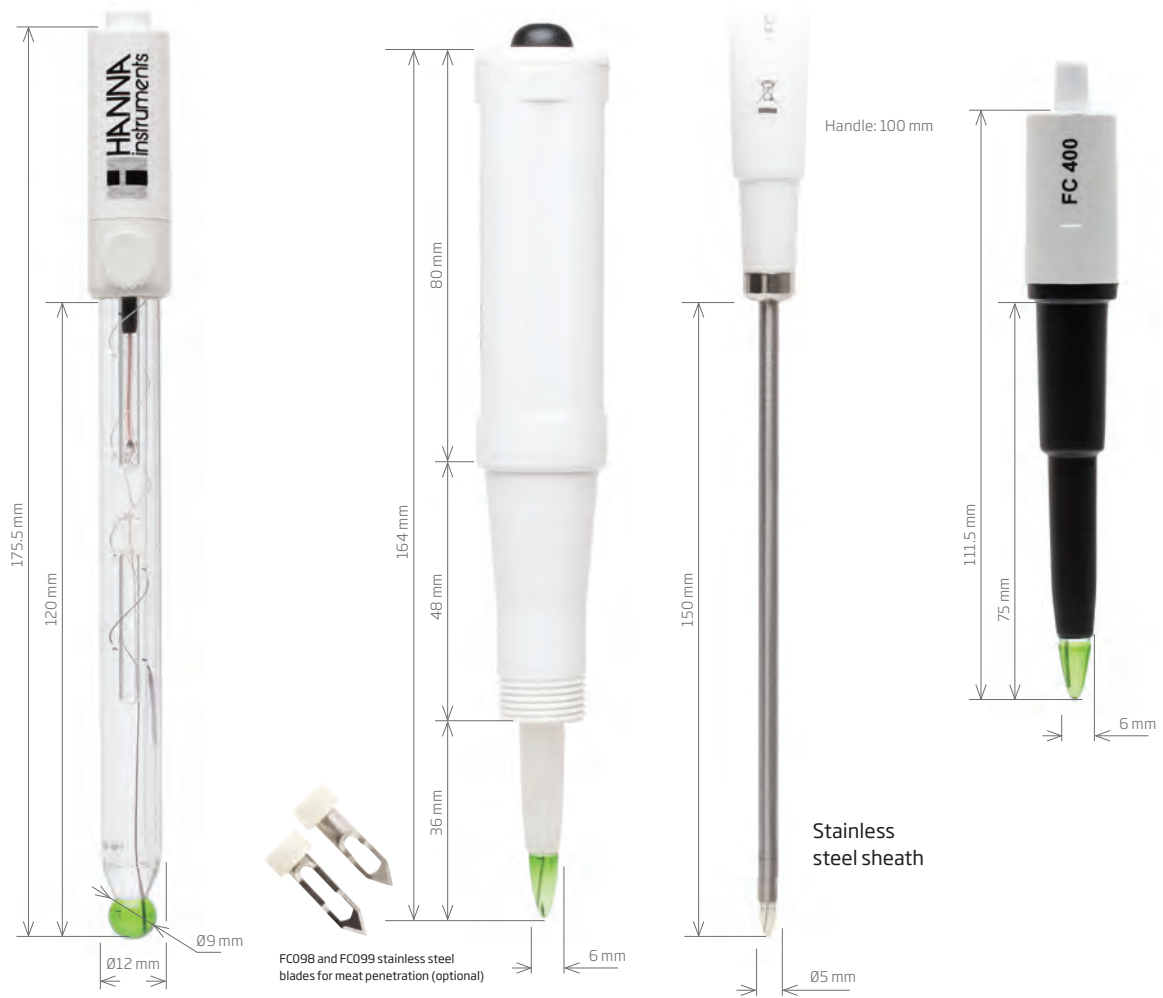

Code	FC220B	FC230B	FC240B	FC400B
Description	pH electrode	combination pH electrode with PVDF outer body	combination pH electrode with stainless steel sheath	pH electrode
Reference	single, Ag/AgCl	single, Ag/AgCl	single, Ag/AgCl	double, Ag/AgCl
Junction / Flow Rate	ceramic, triple / 40-50 µL/h	open	open	open
Electrolyte	KCl 3.5M + AgCl	viscolene	gel	viscolene
Max Pressure	0.1 bar	0.1 bar	0.1 bar	0.1 bar
Range	pH: 0 to 12	pH: 0 to 12	pH: 0 to 13	pH: 0 to 12
Recommended Operating Temp.	-5 to 70°C (23 to 158°F)	0 to 50°C (32 to 122°F)	0 to 50°C (32 to 122°F)	0 to 60°C (32 to 140°F)
Glass Type	LT (low temperature)	LT (low temperature)	GP (general purpose)	LT (low temperature)
Tip /Shape	spheric (dia: 9.5 mm)	conic (6 x 10 mm)	conic (3 x 5 mm)	conic (6 x 10 mm)
Temperature Sensor	no	no	no	no
Amplifier	no	no	no	no
Body Material	glass	PVDF	titanium	PVDF
Cable	coaxial; 1 m (3.3')	coaxial; 1 m (3.3')	coaxial; 1 m (3.3')	coaxial; 1 m (3.3')
Recommended Use	creams, fruit juices, sauces	meat, semi frozen products	penetration, cheese, quality control	penetration, meat
Connection	<b>FC220B</b> BNC	<b>FC230B</b> BNC	<b>FC240B</b> BNC	<b>FC400B</b> BNC

# 2 Electrodes for the Food Industry

pH

electrodes

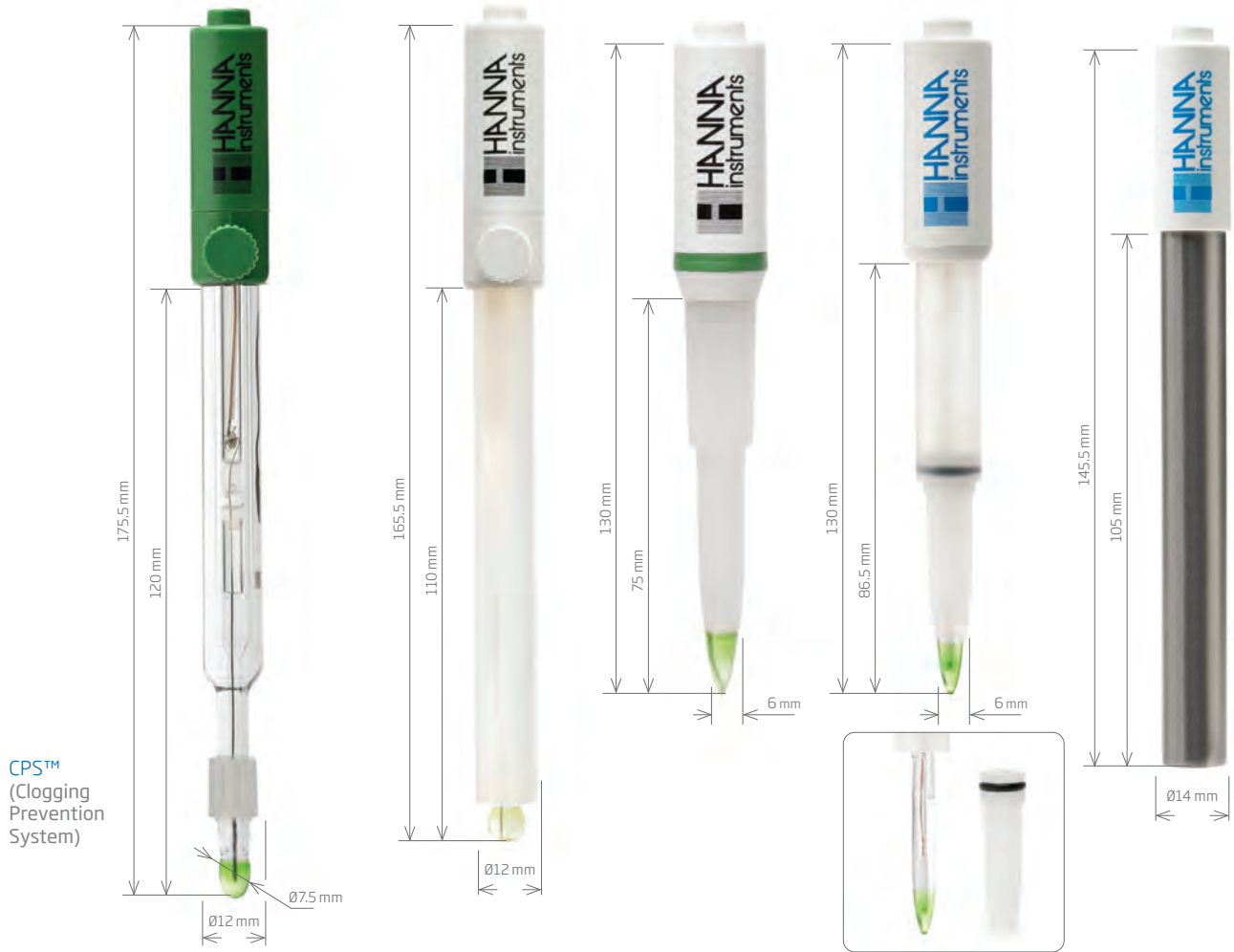

Code	HI1048[ ] • FC10483	FC911	FC2023	FC2053	FC2143
Description	pH electrode with CPS™ (Clogging Prevention System)	pH electrode	pH electrode	pH electrode	pH electrode
Reference	double, Ag/AgCl	double, Ag/AgCl	double, Ag/AgCl	double, Ag/AgCl	single, Ag/AgCl
Junction / Flow Rate	CPS™	ceramic, single / 15-20 µL/H	open	open	cloth
Electrolyte	KCl 3.5M	KCl 3.5M	viscolene	gel	gel
Max Pressure	0.1 bar	0.1 bar	0.1 bar	0.1 bar	3 bar
Range	pH: 0 to 12	pH: 0 to 13	pH: 0 to 12	pH: 0 to 12	pH: 0 to 12
Recommended Operating Temp.	-5 to 60°C (23 to 140°F)	0 to 70°C (32 to 158°F)	0 to 60°C (32 to 140°F)	0 to 60°C (32 to 140°F)	0 to 80°C (32 to 176°F)
Glass Type	LT (low temperature)	GP (general purpose)	LT (low temperature)	LT (low temperature)	LT (low temperature)
Tip / Shape	dome (dia: 8 mm)	spheric (dia: 7.5 mm)	conic (6 x 10 mm)	conic (6 x 10 mm)	flat
Temperature Sensor	DIN and BNC + RCA model only	no	yes	yes	yes
Amplifier	DIN model only	yes	yes	yes	yes
Body Material	glass	PVDF	PVDF	PVDF	titanium with HT glass sensor
Cable	coaxial; 1 m (3.3')	coaxial; 1 m (3.3')	7-pole; 1 m (3.3')	7-pole; 1 m (3.3')	7-pole; 1 m (3.3')
Recommended Use	must in winemaking	creams, fruit juices, sauces, high humidity	yogurt, cheese, meat, semi-solid foods, fruits, ham and sausages	yogurt, cheese, meat, semi-solid foods, fruits, ham and sausages	beer
Connection	<b>HI1048B</b> BNC <b>HI1048B/50</b> BNC (4 m (1.3') cable) <b>HI1048P</b> BNC + pin* <b>FC10483</b> Quick Connect DIN** <b>HI1048Y</b> BNC + RCA***	<b>FC911B</b> BNC	<b>FC2023</b> Quick Connect DIN *	<b>FC2053</b> Quick Connect DIN *	<b>FC2143</b> Quick Connect DIN *

\* For pH meters with CAL Check™ system  
\*\* Recommended for use with HI99111 pH meter  
\*\*\* Thermistor with RCA connector

\* Recommended for use with HI98161 and HI99161 pH meters

\* Recommended for use with HI98161 pH meter

\* Recommended for use with HI98151 pH meter





pH

electrodes

Code	FC2323	HI3148B	FC2133	FC2423	FC2423-1
Description	pH electrode	ORP electrode	pre-amplified pH / temperature probe	pre-amplified pH / temperature probe	pre-amplified pH / temperature probe
Reference	single, Ag/AgCl	double, Ag/AgCl	double	single	single
Junction	open	CPS™	open	open	open
Electrolyte	viscolene	KCl 3.5M	viscolene	viscolene	viscolene
Max Pressure	0.1 bar	0.1 bar	0.1 bar	0.1 bar	0.1 bar
Range	pH: 0 to 12	ORP: ±2000 mV	pH: 0 to 12	pH: 0 to 12	pH: 0 to 12
Recommended Operating Temp.	0 to 50°C (32 to 122°F) - LT	-5 to 60°C (23 to 140°F)	0 to 60°C (32 to 140°F)	0 to 50°C (32 to 122°F)	0 to 50°C (32 to 122°F)
Glass type	LT (low temperature)	-	LT (low temperature)	LT (low temperature)	LT (low temperature)
Tip/Shape	conic (6 x 10 mm)	platinum ring	conic	conic (6 x 8 mm)	conic
Temperature Sensor	yes	no	yes	yes	yes
Amplifier	yes	no	yes	yes	yes
Body Material	PVDF	glass	glass	titanium	titanium
Cable	7-pole; 1 m (3.3')	coaxial; 1 m (3.3')	coaxial; 1 m (3.3')	coaxial; 1 m (3.3')	coaxial; 1 m (3.3')
Recommended Use	meat	must in winemaking	yogurt	penetration, cheese	penetration, cheese
Connection	<b>FC2323</b> Quick Connect DIN*	<b>HI3148B</b> BNC <b>HI3148B/50</b> BNC (.4 m (1.3') cable)	<b>FC2133</b> Quick Connect DIN*	<b>FC2423</b> Quick Connect DIN*	<b>FC2423-1</b> Quick Connect DIN*

\* Recommended for use with HI98163 and HI99163 pH meters

\* Recommended for use with HI98164 and HI99164 pH meter

\* Recommended for use with HI98165 and HI99165 pH meter

# 2 Electrodes for Specific Analysis

pH

electrodes



Code	HI1049B	HI1413B	HI14143	HI14143/50	HI12923
Description	pH electrode with CPS™ (Clogging Prevention System)	pH electrode	pH electrode	pH electrode	pH electrode
Reference	double, Ag/AgCl	single, Ag/AgCl	single, Ag/AgCl	single, Ag/AgCl	single, Ag/AgCl
Junction	CPS™	open	open	open	ceramic, triple / 40-50 µL/h
Electrolyte	KCl 3.5M	viscolene	viscolene	viscolene	KCl 3.5M + AgCl
Max Pressure	0.1 bar	0.1 bar	0.1 bar	0.1 bar	0.1 bar
Range	pH: 0 to 12	pH: 0 to 12	pH: 0 to 12	pH: 0 to 12	pH: 0 to 12
Recommended Operating Temp.	0 to 60°C (32 to 140°F)	0 to 50°C (32 to 122°F)	0 to 50°C (32 to 122°F)	0 to 50°C (32 to 122°F)	-5 to 70°C (23 to 158°F)
Glass Type	LT (low temperature)	LT (low temperature)	LT (low temperature)	LT (low temperature)	LT (low temperature)
Tip /Shape	dome (dia: 8 mm)	flat	flat	flat	conic (12 x 12 mm)
Temperature Sensor	no	no	yes	yes	yes
Amplifier	no	no	yes	yes	yes
Body Material	glass	glass	glass	glass	glass
Cable	coaxial; 1 m (3.3')	coaxial; 1 m (3.3')	7-pole; 1 m (3.3')	7-pole; 1 m (3.3')	7-pole; 1 m (3.3')
Recommended Use	non-aqueous titrations	surface, skin, leather, paper, emulsions	surface, leather, paper, emulsions	skin, scalp	direct soil pH measurement, soil solution
Connection	<b>HI1049B</b> BNC	<b>HI1413B</b> BNC	<b>HI14143</b> Quick Connect DIN*	<b>HI14143/50</b> Quick Connect DIN*	<b>HI12923</b> Quick Connect DIN*

\* Recommended for use with HI99171 pH meter

\* Recommended for use with HI99181 pH meter

\* Recommended for use with HI99121 pH meter



pH

electrodes

Code	HI12943	FC2153	HI12963	HI12973
Description	pH electrode	pH electrode	pH electrode	pH/ORP electrode
Reference	single, Ag/AgCl	single, Ag/AgCl	single, Ag/AgCl	single, Ag/AgCl
Junction	ceramic, triple / 40-50 $\mu$ L/h	ceramic, triple	cloth	cloth
Electrolyte	KCl 3.5M + AgCl	KCl 3.5M + AgCl	gel	gel
Max Pressure	0.1 bar	0.1 bar	3 bar	3 bar
Range	pH: 0 to 12	pH: 0 to 12	pH: 0 to 13	pH: 0 to 13; ORP
Recommended Operating Temp.	-5 to 70°C (23 to 158°F)	-5 to 70°C (23 to 158°F)	0 to 70°C (32 to 158°F)	0 to 70°C (32 to 158°F)
Glass Type	LT (low temperature)	LT (low temperature)	GP (general purpose)	GP (general purpose)
Tip /Shape	conic (12 x 12 mm)	spheric (dia: 9.5 mm)	spheric (dia: 5 mm)	pH: conic (3 mm); ORP: platinum sensor
Temperature Sensor	yes	yes	yes	yes
Amplifier	yes	yes	yes	yes
Body Material	glass	glass	titanium	titanium
Cable	7-pole; 1 m (3.3')	coaxial; 1 m (3.3')	7-pole; 1 m (3.3')	7-pole; 1 m (3.3')
Recommended Use	direct soil, soilless media, soil solution	drinking water	wastewater	wastewater, municipal water, water treatment, swimming pools
Connection	<b>HI12943</b> Quick Connect DIN*	<b>FC2153</b> DIN*	<b>HI12963</b> Quick Connect DIN*	<b>HI12973</b> Quick Connect DIN*

\* Only for use with HI9814  
GroLine® multiparameter meter

\* Recommended for use with HI99192  
pH meter

\* Recommended for use with  
HI98190 and HI991001 pH meter

\* Recommended for use with HI991003 pH  
meter

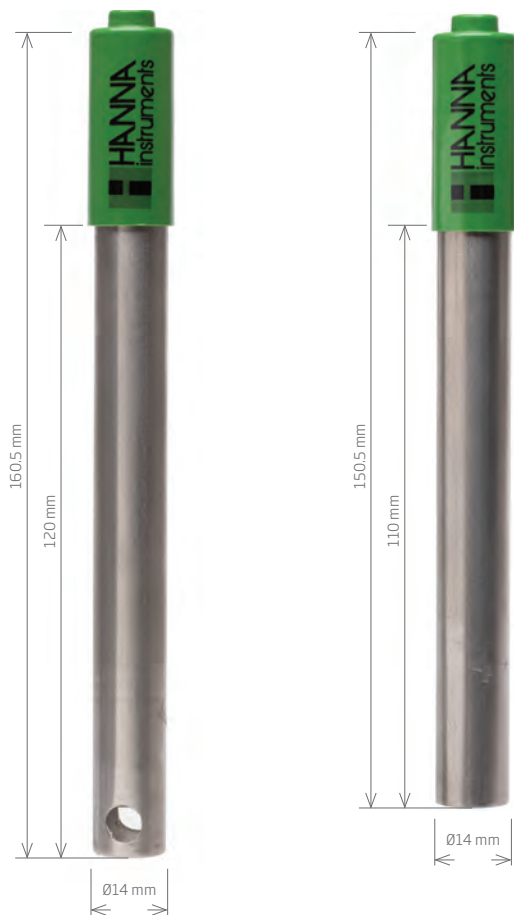

## Electrode Extension Cables

### Screw Type to BNC Cables / Connectors

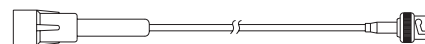

#### Description

3.0 mm (0.12") cable with screw type and BNC connectors

Part #	Cable Length
HI7855/1	1 m (3.3')
HI7855/3	3 m (9.9')
HI7855/5	5 m (16.5')
HI7855/10	10 m (33')
HI7855/15	15 m (49.5')

### BNC to BNC Cables / Connectors

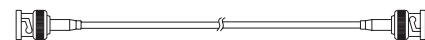

#### Description

3.0 mm (0.12") cable with BNC connectors

Part #	Cable Length
HI7858/1	1 m (3.3')
HI7858/5	5 m (16.5')
HI7858/10	10 m (33')

Code	HI629113	HI729113 [ ]
Description	pH electrode	pH electrode
Reference	double, Ag/AgCl	double, Ag/AgCl
Junction	PTFE	PTFE
Electrolyte	polymer	polymer
Max Pressure	3 bar	3 bar
Range	pH: 0 to 13	pH: 0 to 13
Recommended Operating Temp.	0 to 80°C (32 to 176°F)	0 to 80°C (32 to 176°F)
Glass Type	GP (general purpose)	GP (general purpose)
Tip / Shape	flat	flat
Temperature Sensor	yes	yes
Amplifier	yes	yes
Body Material	titanium body working as matching pin	
Cable	7-pole; 1 m (3.3')	7-pole; 1 m (3.3')
Recommended Use	plating baths	cooling towers, boilers
Connection	<b>HI629113</b> Quick Connect DIN*	<b>HI729113</b> Quick Connect DIN** <b>HI72911B</b> BNC + phono†

\* Recommended for use with HI99131 pH meter

\*\* Recommended for use with HI99141 pH meter  
† Recommended for use with HI98191 pH meter

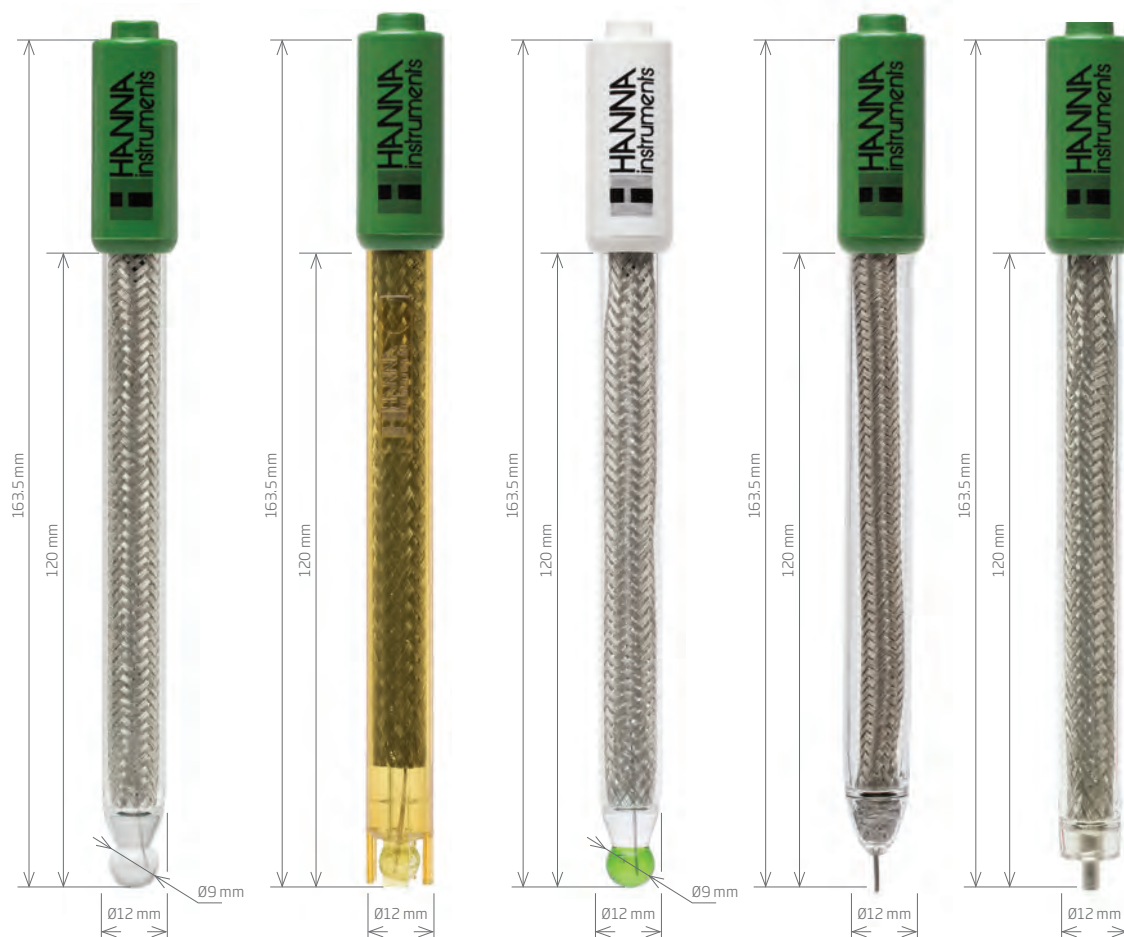

pH

electrodes

Code	HI2111B	HI2112B	FC260B	HI3133B	HI5110B
Description	pH half-cell	pH half-cell	pH half-cell	ORP half-cell	ORP half-cell
Half Cell	-	-	-	platinum	Ag
Range	pH: 0 to 14	pH: 0 to 13	pH: 0 to 12	mV	mV
Recommended Operating Temp.	0 to 100°C (32 to 212°F)	0 to 70°C (32 to 158°F)	-5 to 80°C (23 to 176°F)	-5 to 100°C (23 to 212°F)	0 to 70°C (32 to 158°F)
Glass Type	HT (high temperature)	GP (general purpose)	LT (low temperature)		
Tip /Shape	spheric (dia: 9.5 mm)	spheric (dia: 7.5 mm)	spheric (dia: 9.5 mm)	platinum pin	cylindric (dia: 3 mm)
Body Material	glass	PEI	glass	glass	glass
Cable	coaxial	coaxial	coaxial	coaxial	coaxial
Recommended Use	general purpose, strong alkaline solutions	general purpose	milk	general purpose, potentiometric titration	argentometric titration
Connection	<b>HI2111B</b> BNC	<b>HI2112B</b> BNC	<b>FC260B</b> BNC	<b>HI3133B</b> BNC	<b>HI5110B</b> BNC



Code	HI5412	HI5311	HI5314	HI5414
Description	reference electrode	reference electrode	reference electrode	reference electrode
Reference	single, Hg/Hg <sub>2</sub> Cl <sub>2</sub>	double, Ag/AgCl	double, Ag/AgCl	single, Hg/Hg <sub>2</sub> Cl <sub>2</sub>
Junction / Flow Rate	ceramic, single / 15-20 µL/h	ceramic, single / 15-20 µL/h	ceramic, double	ceramic, double
Electrolyte	KCl 3.5M	KCl 3.5M	KCl 3.5M	KCl 3.5M
Max Pressure	0.1 bar	0.1 bar	3 bar with back pressure	3 bar with back pressure
Recommended Operating Temp.	-5 to 60°C (23 to 140°F)	-5 to 100°C (23 to 212°F)	-5 to 100°C (23 to 212°F)	-5 to 60°C (23 to 140°F)
Body Material	glass	glass	glass	glass
Cable	1 m (3.3')	1 m (3.3')	1 m (3.3')	1 m (3.3')
Recommended Use	general purpose, titrations	general purpose, titrations	measurements with remote filling	measurements with remote filling
Connection	<b>HI5412</b> 4 mm banana	<b>HI5311</b> 4 mm banana	<b>HI5314</b> 4 mm banana	<b>HI5414</b> 4 mm banana



### High pressure or high concentration of contaminants

Because of the special electrode recharge system of the HI5314 and HI5414, it is possible to connect an outside container. This will increase the amount of electrolyte of the reference half cell and thus, the pressure inside the electrode. By so doing, the junction has the ability to work in high pressure environments without the danger of implosion.



Code	HI5413	HI5312	HI5313
Description	reference electrode	reference electrode	reference electrode
Reference	single, Hg/Hg <sub>2</sub> Cl <sub>2</sub>	double, Ag/AgCl	single, Ag/AgCl
Junction / Flow Rate	PE sleeve	PE sleeve	ceramic
Electrolyte	KCl 3.5M	KCl 3.5M	gel (KCl 1M + AgCl)
Max Pressure	0.1 bar	0.1 bar	0.1 bar
Recommended Operating Temp.	-5 to 60°C (23 to 140°F)	0 to 60°C (32 to 140°F)	-5 to 60°C (23 to 140°F)
Body Material	glass	glass	PEI
Cable	1 m (3.3')	1 m (3.3')	1 m (3.3')
Recommended Use	samples with suspended solids	titrations, samples with suspended solids	titrations, samples with suspended solids
Connection	<b>HI5413</b> 4 mm banana	<b>HI5312</b> 4 mm banana	<b>HI5313</b> 4 mm banana

### Hanna seal of freshness

Our air-tight bottle with tamper-proof seal of freshness ensures quality.



### Table of Reference Temperatures

All calibration solution bottles are provided with a label presenting a reference table of the relationship between pH or conductivity values and temperature.

### Ready-made Solutions

Buffer solutions that can be prepared in small batches from capsules, tablets or powders, are called “fresh” because they are prepared at the time of use. They are considered to be, but are not very precise. The quality of buffer solutions produced depends on many factors including the quantity and quality of the chemicals and distilled water used in production. Other important factors are the temperature and the instruments used to prepare them.

**Hanna buffer solutions are checked carefully, in an aseptic environment with the highest precision reference instruments, and are calibrated to NIST Standards.**

Hanna solutions are more convenient than the so-called “fresh” solutions. The main standard buffer solutions produced by Hanna are available in bottles or in sealed sachets, complete with or without a certificate of analysis.

The following pages show the series of calibration solutions in the various types of packages that will satisfy every application need, while always guaranteeing a highly accurate buffer.



### Certified Solutions

For those operators who request it, we provide standard solutions complete with certificate of analysis. These certificates are prepared in accordance with NIST standards to avoid any possible error in determining the actual pH value. The certificate shows the date of production, batch number and expiration date.

### Safety Data Sheets

Download Safety Data Sheets (SDS) from our website at: [www.hannainst.com](http://www.hannainst.com).



### Calibration and Cleaning Solutions

The fundamental use of calibration and cleaning solutions is to correctly maintain electrode operation to assure accurate and reproducible readings. Often, readings are not correct because the sensors have not been properly handled. Using Hanna's wide range of solutions will help guarantee proper cleaning and calibration of electrodes and probes for maximum performance.



### Sachets are Practical, Safe and Ready-to-Use

Single-use sachets are quick and easy to use. Each sealed, opaque sachet holds just the right amount of solution. Every time your instrument and probe is maintained using Hanna sachets, it is like using a newly opened bottle of solution.

A wide range of pH, conductivity, TDS, and cleaning solutions are available.

### Table of Reference Temperatures

A label presenting a reference table of the relationship between pH or conductivity values and temperature is printed on all calibration solution sachets.



## Step 1: Cleaning

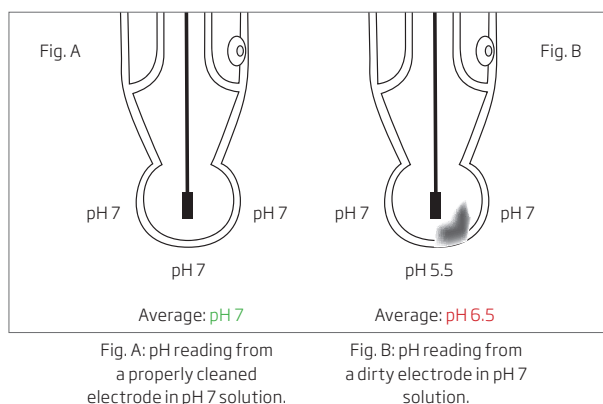

### Just because you can't see contamination doesn't mean it isn't there.

An electrode generates a voltage of the average hydrogen ion concentration from the surface area outside the pH bulb tip. Fig. A above shows that the clean electrode is submersed in pH 7 from all areas of the bulb surface.

When an electrode becomes dirty from use or neglect, the contaminated surface contributes to a voltage offset based on the surface area exposed to buffer as seen in Fig. B. Now the pH meter is mistakenly reading pH 6.5 instead of the actual pH 7.

Always clean your electrode before calibration. If a dirty electrode is used for calibration, all subsequent measurements will be in error.

### A dirty electrode can contaminate solutions.

Always use fresh solutions with each calibration. Buffer solutions can be contaminated by dirty electrodes as in Fig. C. Always clean your electrode before each calibration and measurement, and always use fresh solutions.

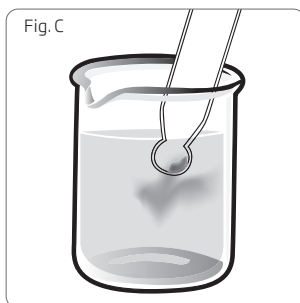

Contamination can take time to work its way around the beaker. If you notice fluctuations in your readings, it may be time to calibrate with fresh solutions.

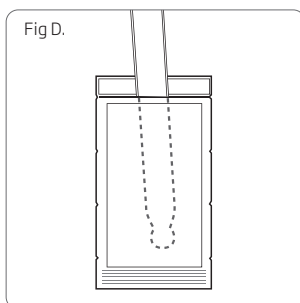

### Fresh Every Time

Hanna single-use sachets are a great way to ensure your solution is always fresh. Fig. D shows just how easy it is to tear open the packet and insert the electrode. These opaque sachets are also the ideal size for testers.

## pH Cleaning Procedure

Hanna manufactures a full complement of cleaning solutions formulated to address general and specific cleaning needs.

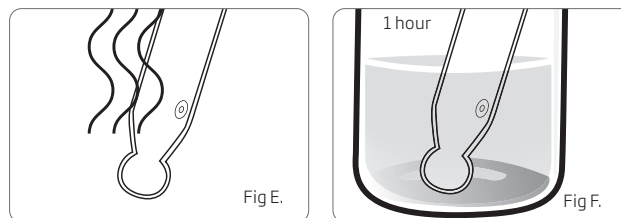

**IMPORTANT:** After performing any of the cleaning procedures, rinse the electrode thoroughly with purified water (Fig. E) and soak the electrode in HI70300 or HI80300 Storage Solution for at least 1 hour before taking measurements (Fig. F).

## General Cleaning

Soak in Hanna HI7061 or HI8061 General Cleaning Solution for approximately 30 minutes to dissolve mineral deposits and other general coatings.

## Protein Coating

Soak in Hanna HI7073 or HI8073 Protein Cleaning Solution for 15 minutes to enzymatically dissolve deposits from protein sources.

## Inorganic Soak

Soak in Hanna HI7074 Inorganic Cleaning Solution for 15 minutes. This cleaner is especially effective at removal of precipitates caused by reaction with the silver in the filling solution that may form in a ceramic junction.

## Oil and Grease Rinse

Oil and grease removal require the correct chemicals to solubilize the coating, but mild enough to leave the electrode unaffected. Use Hanna HI7077 or HI8077 Oil and Fat Cleaning Solution.

## Step 2: Calibration

### Calibration only counts when using fresh solutions and properly cleaned electrodes.

A pH electrode that is properly manufactured and kept clean will retain its measuring integrity for a long time. As a result of many factors such as age, use, poor maintenance, or improper handling, any electrode will lose its integrity in time.

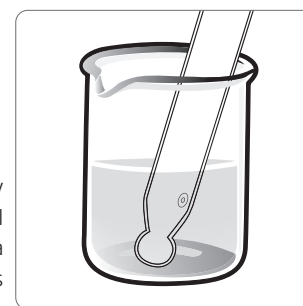

Routine maintenance will ensure accurate readings while extending the life of your electrode.

## pH and ORP Solutions

A proper calibration restores the ability of an electrode to take accurate measurements. The most common cause for pH measurement inaccuracies is an unclean or improperly cleaned electrode. This is very important to note because during calibration, the instrument assumes that the electrode is clean and that the standardization curve created during the calibration process will remain a valid reference until the next calibration. pH meters on the market today will allow an offset of approximately  $\pm 60$  mV while Hanna only allows an offset of approximately  $\pm 30$  mV. An offset voltage is the mV at 7.00 pH. The deviation from 0 mV is not unusual, in fact it represents the true characteristics of a normal pH electrode.

An offset can be compensated for by calibrating a pH meter with a properly cleaned electrode. Calibrating a meter with a dirty electrode will only compound the problem. An mV offset that continues to deviate with a properly cleaned electrode is a good indication that the electrode may need to be replaced.

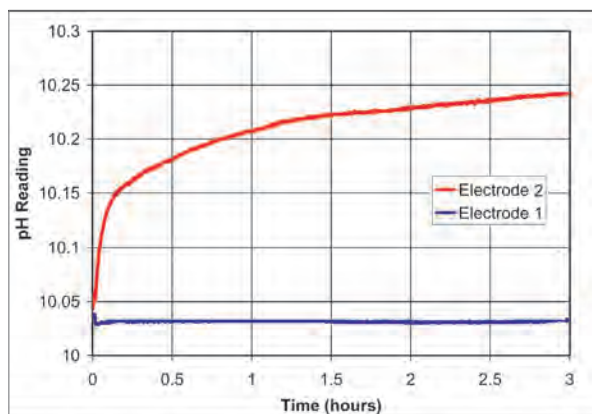

Fig G.

Electrode 1 has been properly cleaned before calibration.  
Electrode 2 has not been properly cleaned.

### Electrode readings may vary with insufficient cleanings.

Fig. G (above) shows that the pH measured by a dirty electrode changes over a short period of time, resulting from the residue on the pH electrode bulb. The resulting pH measurements, based upon the calibration of a coated electrode, will then be incorrect.

Conventional pH meters do not warn the user when a pH electrode is dirty or when a solution may be contaminated. A common example of this occurs just after calibrating the instrument; the pH electrode is immersed into the pH 7 buffer and the reading is lower than expected (pH 6.8 or 6.9 instead of pH 7). Hanna meters that feature our exclusive CAL Check™ electrode diagnostics automatically alert the user of any potential electrode or solution problems during calibration.

### Precision Solutions

Hanna's wide range of solutions will help guarantee correct cleaning and calibration of electrodes and probes for maximum performance. Our solutions have been manufactured with your application in mind.

## Step 3: Maintenance

### Measurement

Always calibrate the electrode and pH meter together before making measurements. Rinse the pH electrode sensor tip with deionized or distilled water. For a faster response, and to avoid cross-contamination of the samples, rinse the electrode tip with a few drops of the solution to be tested. Before taking measurements submerge the pH sensor tip and reference junction ( $\sim 3$  cm /  $1\frac{1}{4}$ " ) in the stirred sample.

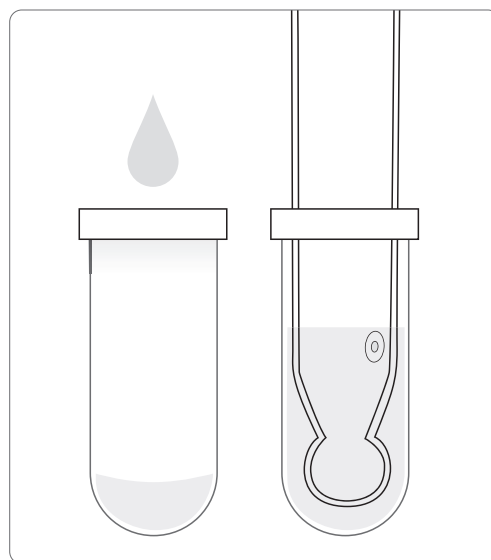

Fig H

### Storage

To ensure an optimum response time, the glass sensor tip and the reference junction of the pH electrode should be kept moist and not be allowed to dry out.

Replace the solution in the protective cap with a few drops of HI70300 or HI80300 Storage Solution or, in its absence, with pH 4 or pH 7 buffer (Fig H).

*NOTE: Never store the electrode in distilled or deionized water.*



### Inspect

Inspect and clean the electrode on a regular schedule to ensure the electrode will be ready when you need it. Coatings and reactions from samples result in decreased efficiency and longer response times.



HI5000 Series

## pH Technical Calibration Solutions

- Supplied with Certificate of Analysis
- Accuracy of  $\pm 0.01$  pH @ 25°C
- Safety Data Sheets
  - Safety data sheets for all Hanna solutions are available at [hannainst.com](http://hannainst.com) or upon request.
- Expiration date
  - The production batch number, expiration date, and temperature correlation table are reported on all Hanna calibration solutions.
- NIST traceability
  - Standardized using a meter and specially designed multi-reference probe. Reported values are traceable to NIST Standard Reference Materials (SRMs).
- Air-tight bottles
  - Air-tight bottle with tamper-proof seal of freshness to ensure quality.
- Single use sachets
  - opaque packaging prevents oxidation from UV light that could alter the value. Every sachet is as fresh as the day it was packaged.

### Technical Solutions ( $\pm 0.01$ pH) for Each Point of the pH Scale

To obtain precise and valid pH measurements, the pH meter and electrode must be calibrated at a minimum of two different points, close to the value of the sample to be tested. For this type of calibration, Hanna offers technical solutions for each point of the pH scale.

This complete scale of buffer solutions offers a higher degree of accuracy for pH measurements in specific areas of application, as in monitoring the pH of must and wine. This line includes twenty solutions starting from a value of pH 1.00 up to pH 13.00 with an accuracy of  $\pm 0.01$  pH, thus covering every point of the pH scale.

These solutions are dedicated to applications that require extremely accurate pH monitoring, and come with a certificate of analysis prepared by comparison against NIST standards.

Also available are solution bottles that are colored according to a given standard calibration value: HI5004-R (Red), HI5007-G (Green) and HI5010-V (Violet).

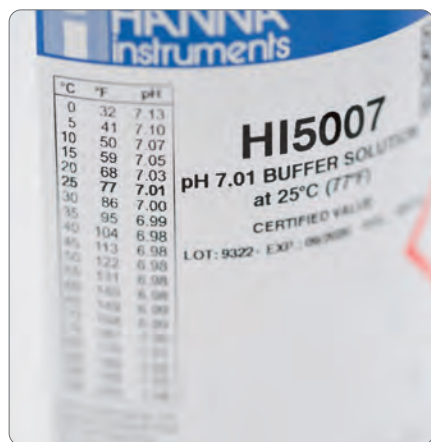

## Table of Reference Temperatures

HI5000 calibration solutions are provided with a label presenting a reference table of the relationship between pH or conductivity values and temperature.



## Bottles

pH Value @25°C	Code	Package	Certificate of Analysis
1.00	HI5001	500 mL	•
1.68	HI5016	500 mL	•
2.00	HI5002	500 mL	•
2.00	HI5002-01	1 L	•
3.00	HI5003	500 mL	•
4.01	HI5004	500 mL	•
4.01	HI5004-01	1 L	•
4.01	HI5004-R	500 mL (color coded solution)	•
4.01	HI5004-R08	1 G (3.78 L) (2) (color coded solution)	•
5.00	HI5005	500 mL	•
5.00	HI5005-01	1 L	•
6.00	HI5006	500 mL	•
6.86	HI5068	500 mL	•
7.01	HI5007	500 mL	•
7.01	HI5007-01	1 L	•
7.01	HI5007-G	500 mL (color coded solution)	•
7.01	HI5007-G08	1 G (3.78 L) (2) (color coded solution)	•
7.41	HI5074	500 mL	•
8.00	HI5008	500 mL	•
8.00	HI5008-01	1 L	•
9.00	HI5009	500 mL	•
9.18	HI5091	500 mL	•
10.01	HI5010	500 mL	•
10.01	HI5010-01	1 L	•
10.01	HI5010-V	500 mL (color coded solution)	•
10.01	HI5010-V08	1 G (3.78 L) (2) (color coded solution)	•
11.00	HI5011	500 mL	•
12.00	HI5012	500 mL	•
12.45	HI5124	500 mL	•
13.00	HI5013	500 mL	•

## Sachets

pH Value @25°C	Code	Package	Certificate of Analysis
1.00	HI50001-02	20 mL (25)	•
1.68	HI50016-02	20 mL (25)	•
2.00	HI50002-02	20 mL (25)	•
3.00	HI50003-02	20 mL (25)	•
4.01	HI50004-02	20 mL (25)	•
5.00	HI50005-02	20 mL (25)	•
6.86	HI50068-02	20 mL (25)	•
7.01	HI50007-02	20 mL (25)	•
9.00	HI50009-02	20 mL (25)	•
9.18	HI50091-02	20 mL (25)	•
10.01	HI50010-02	20 mL (25)	•
11.00	HI50011-02	20 mL (25)	•
12.00	HI50012-02	20 mL (25)	•
12.45	HI50124-02	20 mL (25)	•
13.00	HI50013-02	20 mL (25)	•

## Hanna Combination Kits in Bottles

Use our combination kits for easy ordering and reordering.

Code	Solutions (pH Value @25°C)	Bottle	Certificate of Analysis
HI54710	pH 4.01, pH 7.01, pH 10.01	500 mL (3)	•
HI54710-10	pH 4.01, pH 7.01, pH 10.01, HI70300L	500 mL (4)	•
HI54710-11	pH 4.01, pH 7.01, pH 10.01, HI70300L, HI7061L	500 mL (5)	•

## HI6000 Series

## ±0.002 pH Millesimal Calibration Solutions

- Supplied with Certificate of Analysis
- Accuracy of ±0.002 pH @ 25°C
- Safety Data Sheets
  - Safety data sheets for all Hanna solutions are available at hannainst.com or upon request.
- Expiration date
  - The production batch number, expiration date, and temperature correlation table are reported on all Hanna calibration solutions.
- NIST traceability
  - Standardized using a meter and specially designed multi-reference probe. Reported values are traceable to NIST Standard Reference Materials (SRMs).
- Air-tight bottles
  - Air-tight bottle with tamper-proof seal of freshness to ensure quality.
- Single use sachets
  - Opaque packaging prevents oxidation from UV light that could alter the value. Every sachet is as fresh as the day it was packaged.
- Opaque bottles
  - Prevents any oxidation from UV light that could alter the buffer value.



## Bottles

pH Value @25°C	Code	Package	Certificate of Analysis
1.000	HI6001	500 mL	•
1.679	HI6016	500 mL	•
2.000	HI6002	500 mL	•
3.000	HI6003	500 mL	•
4.010	HI6004	500 mL	•
4.010	HI6004-01	1 L	•
6.000	HI6006	500 mL	•
6.862	HI6068	500 mL	•
7.010	HI6007	500 mL	•
7.010	HI6007-01	1 L	•
7.413	HI6074	500 mL	•
8.000	HI6008	500 mL	•
9.000	HI6009	500 mL	•
9.177	HI6091	500 mL	•
10.010	HI6010	500 mL	•
10.010	HI6010-01	1 L	•
11.000	HI6011	500 mL	•
12.000	HI6012	500 mL	•
12.450	HI6124	500 mL	•
13.000	HI6013	500 mL	•

## Sachets

pH Value @25°C	Code	Package	Certificate of Analysis
1.000	HI60001-02	20 mL (25)	•
1.679	HI60016-02	20 mL (25)	•
2.000	HI60002-02	20 mL (25)	•
4.010	HI60004-02	20 mL (25)	•
7.010	HI60007-02	20 mL (25)	•
10.010	HI60010-02	20 mL (25)	•

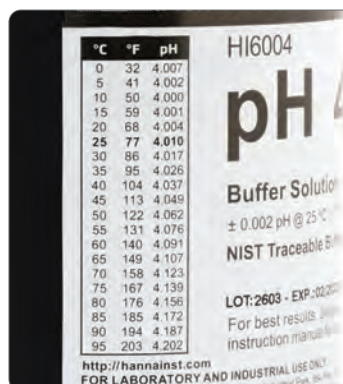

## Table of Reference Temperatures

HI6000 calibration solutions are provided with a label presenting a reference table of the relationship between pH or conductivity values and temperature.

## Quick Cal

### pH/EC Quick Cal Calibration Solution

Quick Cal is for use with Hanna's GroLine® pH and/or EC/TDS meters. Using the Quick Cal function found in compatible meters allows for single-point calibration for pH and/or conductivity sensors.

- Calibration solution for GroLine pH and EC/TDS meters
- pH calibration buffer value of pH 6.86
- EC calibration standard value of 5,000  $\mu\text{S}/\text{cm}$  (5.00 mS/cm)
- Safety Data Sheets
  - Safety data sheets for all Hanna solutions are available at [hannainst.com](http://hannainst.com) or upon request.
- Expiration date
  - The production batch number, expiration date, and temperature correlation table are reported on all Hanna calibration solutions.
- NIST traceability
  - Standardized using a pH meter calibrated by means of two standard solutions prepared from NIST standard reference materials. A conductivity meter and probe calibrated against NIST primary standard solutions or primary standard solutions prepared following NIST guidelines.



- Air-tight bottles
  - Air-tight bottle with tamper-proof seal of freshness to ensure quality.
- Single use sachets
  - Opaque packaging prevents oxidation from UV light that could alter the value. Every sachet is as fresh as the day it was packaged.

#### Quick Cal pH/EC Bottles

Code	Size	Certificate of Analysis
HI5036-050	500 mL (GroLine)	•
HI5036-023	230 mL (GroLine)	•
HI5036-012	120 mL (GroLine)	•

#### Quick Cal pH/EC Sachets

Code	Size	Certificate of Analysis
HI50036P	20 mL sachets, 25 pcs. (GroLine)	•

# pH Buffer Solutions

- **Safety Data Sheets**
  - Safety data sheets for all Hanna solutions are available at [hannainst.com](http://hannainst.com) or upon request.
- **Expiration date**
  - The production batch number, expiration date, and temperature correlation table are reported on all Hanna calibration solutions.
- **NIST traceability**
  - Standardized using a pH meter calibrated by means of two standard solutions prepared from NIST standard reference materials.



- **Air-tight bottles**
  - Air-tight bottle with tamper-proof seal of freshness to ensure quality.
- **Single use sachets**
  - Opaque packaging prevents oxidation from UV light that could alter the value. Every sachet is as fresh as the day it was packaged.
- **FDA compliant bottles (HI80xx)**
  - Hanna solutions are offered in opaque bottles that meet FDA requirements.

## 4.01 pH Buffer Solution

This buffer value is widely used in water purification plants, in the food industry, and wherever the pH is expected to be slightly acidic.



## 4.01 pH @ 25°C - Bottles

Code	Size	FDA Bottle	Certificate of Analysis
HI7004/1G	1 G (3.78 L) (color coded solution)		on request
HI7004/1L	1 L (color coded solution)		on request
HI7004L	500 mL		on request
HI7004L/C	500 mL		•
HI7004C	500 mL (color coded solution)		on request
HI7004M	230 mL		on request
HI7004-050	500 mL (GroLine®)		•
HI7004-023	230 mL (GroLine)		•
HI7004-012	120 mL (GroLine)		•
HI8004L	500 mL	•	•
HI8004L/C	500 mL	•	•

## 4.01 pH @ 25°C - Sachets

Code	Size	Package	Certificate of Analysis
HI70004C	20 mL	25 pcs.	•
HI70004G	20 mL (GroLine)	25 pcs.	•
HI70004P	20 mL	25 pcs.	
HI700044P	20 mL (Pool Line)	25 pcs.	

## 4.01 and 7.01 pH @ 25°C - Sachets

Code	Size	Package	Certificate of Analysis
HI77400C	20 mL	10 pcs., 5 ea	•
HI77400P	20 mL	10 pcs., 5 ea	



# pH Buffer Solutions

- Safety Data Sheets
  - Safety data sheets for all Hanna solutions are available at [hannainst.com](http://hannainst.com) or upon request.
- Expiration date
  - The production batch number, expiration date, and temperature correlation table are reported on all Hanna calibration solutions.
- NIST traceability
  - Standardized using a pH meter calibrated by means of two standard solutions prepared from NIST standard reference materials.



## 7.01 pH @ 25°C - Bottles

Code	Size	FDA Bottle	Certificate of Analysis
HI70071G	1 G (3.78 L) (color coded solution)		on request
HI70071L	1 L (color coded solution)		on request
HI7007C	500 mL (color coded solution)		on request
HI7007L	500 mL		on request
HI7007L/C	500 mL		•
HI7007M	230 mL		on request
HI7007-050	500 mL (GroLine®)		•
HI7007-023	230 mL (GroLine)		•
HI7007-012	120 mL (GroLine)		•
HI8007L	500 mL	•	•
HI8007L/C	500 mL	•	•

## 7.01 pH @ 25°C, and Combination Packs - Sachets

Code	Value	Size	Package	Certificate of Analysis
HI70007C	7.01 pH	20 mL	25 pcs.	•
HI70007G	7.01 pH (GroLine)	20 mL	25 pcs.	•
HI70007P	7.01 pH	20 mL	25 pcs.	
HI700074P	7.01 pH (Pool Line)	20 mL	25 pcs.	
HI77700P	7.01 pH	20 mL	10 pcs.	
HI770710C	10.01 & 7.01 pH	20 mL	10 pcs., 5 ea	•
HI770710P	10.01 & 7.01 pH	20 mL	10 pcs., 5 ea	
HI77100C	1413 µS/cm & 7.01 pH	20 mL	20 pcs., 10 ea	•
HI77100P	1413 µS/cm & 7.01 pH	20 mL	20 pcs., 10 ea	
HI77200P	1500 mg/L (ppm) & 7.01 pH	20 mL	20 pcs., 10 ea	
HI77400P	4.01 & 7.01 pH	20 mL	10 pcs., 5 ea	

- Air-tight bottles
  - Air-tight bottle with tamper-proof seal of freshness to ensure quality.
- Single use sachets
  - Opaque packaging prevents oxidation from UV light that could alter the value. Every sachet is as fresh as the day it was packaged.
- FDA compliant bottles (HI80xx)
  - Hanna solutions are offered in opaque, bottles that meet FDA requirements.

## 7.01 pH Buffer Solution

pH 7.01 is the most widely used among all buffer solutions. For this reason we have prepared it in a wider variety of sizes to meet application demand.



# pH Buffer Solutions

- **Safety Data Sheets**
  - Safety data sheets for all Hanna solutions are available at [hannainst.com](http://hannainst.com) or upon request.
- **Expiration date**
  - The production batch number, expiration date, and temperature correlation table are reported on all Hanna calibration solutions.
- **NIST traceability**
  - Standardized using a pH meter calibrated by means of two standard solutions prepared from NIST standard reference materials.



- **Air-tight bottles**
  - Air-tight bottle with tamper-proof seal of freshness to ensure quality.
- **Single use sachets**
  - Opaque packaging prevents oxidation from UV light that could alter the value. Every sachet is as fresh as the day it was packaged.
- **FDA compliant bottles (HI80xx)**
  - Hanna solutions are offered in opaque bottles that meet FDA requirements.

## 10.01 pH Buffer Solution

pH 10.01 solution is commonly used to calibrate equipment used for analyzing basic samples. pH 10.01 buffer solution is available in various sizes to best fit your needs.



## 10.01 pH @ 25°C - Bottles

Code	Size	FDA Bottle	Certificate of Analysis
HI7010/1G	1 G (3.78 L) (color coded bottle)		on request
HI7010/1L	1 L (color coded bottle)		on request
HI7010L	500 mL		on request
HI7010C	500 mL (color coded solution)		on request
HI7010L/C	500 mL		•
HI7010M	230 mL		on request
HI7010-050	500 mL (GroLine®)		•
HI7010-023	230 mL (GroLine)		•
HI7010-012	120 mL (GroLine)		•
HI8010L	500 mL	•	•
HI8010L/C	500 mL	•	•

## 10.01 pH @ 25°C, and Combination Packs - Sachets

Code	pH Value	Size	Package	Certificate of Analysis
HI70010C	10.01	20 mL	25 pcs.	•
HI70010P	10.01	20 mL	25 pcs.	•
HI770710C	10.01 & 7.01	20 mL	10 pcs., 5 ea	•
HI770710P	10.01 & 7.01	20 mL	10 pcs., 5 ea	•

## 1.68 pH @ 25°C - Bottles

Code	Size	Certificate of Analysis
HI7001L	500 mL	on request
HI7001M	250 mL	on request

## 6.00 pH @ 25°C - Bottle

Code	Size	Package
HI70060M	230 mL	bottle

## 6.86 pH @ 25°C - Bottles

Code	Size	FDA Bottle	Certificate of Analysis
HI7006/1G	1 G (3.78 L)		on request
HI7006/1L	1 L		on request
HI7006L	500 mL		on request
HI7006L/C	500 mL		•
HI7006M	250 mL		on request
HI8006L	500 mL	•	•
HI8006L/C	500 mL	•	•

## 6.86 pH @ 25°C - Sachets

Code	Size	Package	Certificate of Analysis
HI70006C	20 mL	25 pcs.	•
HI70006P	20 mL	25 pcs.	

## 8.20 pH @ 25°C - Bottle

Code	Size	Package
HI70082M	230 mL	bottle

## 8.30 pH @ 25°C - Bottle

Code	Size	Package
HI70083M	230 mL	bottle

## 9.18 pH @ 25°C - Bottles

Code	Size	FDA Bottle	Certificate of Analysis
HI7009/1G	1 G (3.78 L)		on request
HI7009/1L	1 L		on request
HI7009L	500 mL		on request
HI7009L/C	500 mL		•
HI7009M	250 mL		on request
HI8009L/C	500 mL	•	•
HI8009L	500 mL	•	•

## 9.18 pH @ 25°C - Sachets

Code	Size	Package	Certificate of Analysis
HI70009C	20 mL	25 pcs.	•
HI70009P	20 mL	25 pcs.	

# pH Buffer Solutions

- **Safety Data Sheets**
  - Safety data sheets for all Hanna solutions are available at [hannainst.com](http://hannainst.com) or upon request.
- **Expiration date**
  - The production batch number, expiration date, and temperature correlation table are reported on all Hanna calibration solutions.
- **NIST traceability**
  - Standardized using a pH meter calibrated by means of two standard solutions prepared from NIST standard reference materials.
- **Air-tight bottles**
  - Air-tight bottle with tamper-proof seal of freshness to ensure quality.
- **Single use sachets**
  - Opaque packaging prevents oxidation from UV light that could alter the value. Every sachet is as fresh as the day it was packaged.
- **FDA compliant bottles (HI80xx)**
  - Hanna solutions are offered in opaque bottles that meet FDA requirements.

## 1.68 pH Buffer Solution

Plating bath samples, food samples, and waste samples are often acidic in nature. To increase accuracy of your measurement at lower pH values, it is important to calibrate your electrode and meter at the appropriate pH. pH 1.68 buffer solution allows you to calibrate your measurement system in the acidic pH range and bracket your samples by using a second value at 4.01 pH or near 7.01 pH.

## 6.86 pH Buffer Solution

Many of our portable and benchtop instruments may now be calibrated with both pH 6.86 or pH 7.01 buffers.

## 8.20 and 8.30 pH Buffer Solution

To increase accuracy of your measurement, 8.20 and 8.30 pH buffer solution are available.

## 9.18 pH Buffer Solution

To increase measurement accuracy in an alkaline environment, it is important to calibrate your electrode and meter in that pH range and to preferably bracket your sample values. Hanna offers both pH 9.18 buffer and pH 10.01 buffer to fulfill this requirement.

## ORP and Sample Preparation Solutions

- **Safety Data Sheets**
  - Safety data sheets for all Hanna solutions are available at [hannainst.com](http://hannainst.com) or upon request.
- **Expiration date**
  - The production batch number and expiration date are reported on all Hanna calibration solutions.
- **Air-tight bottles**
  - Air-tight bottle with tamper-proof seal of freshness to ensure quality.

### ORP Test and Pretreatment Solutions

ORP standard solutions allows users to test the precision of ORP electrodes. For example, by immersing the electrode in HI7021 solution, the reading should be at 240 mV (@25°C/77°F).

If the reading is outside the indicated interval, clean and condition your ORP electrode in Hanna pretreatment solution.

Use HI7092 for oxidizing or HI7091 for reducing pretreatment.

### Soil Sample Preparation Solution

HI7051 Soil Sample Preparation Solution is an electrolyte solution used in the measurement of soil pH. The pH of soil is most commonly measured as either a water slurry or electrolyte slurry, where a set ratio of soil:solvent (solvent is water or electrolyte solution) is chosen; common ratios used for soil pH are 1:1, 1:2, or 1:5, where more solvent than soil is used when soils-to-be-analyzed contain high amounts of organic matter or clay. Use of an electrolyte solution is usually preferred as it is less affected by soil electrolyte concentration and provides a more consistent measurement for soils whose salt content may fluctuate as a result of seasonal conditions or crop residues.

Using the HI7051 solution prior to taking a measurement provides for a more accurate pH reading of soil samples.



#### ORP Test and Pretreatment Solution Bottles

Code	Description	Size	Certificate of Analysis
HI7021L	240 mV ORP solution for platinum and gold electrodes	500 mL	on request
HI7021M	240 mV ORP solution for platinum and gold electrodes	230 mL	on request
HI7022L	470 mV ORP solution for platinum and gold electrodes	500 mL	on request
HI70224L	470 mV ORP solution for platinum and gold electrodes	500 mL (Pool Line)	on request
HI7022M	470 mV ORP solution for platinum and gold electrodes	230 mL	on request
HI7091L	reducing pretreatment solution (2 components)	500 mL + 14g (set)	
HI7092L	oxidizing pretreatment solution for ORP electrodes	500 mL	
HI7092M	oxidizing pretreatment solution for ORP electrodes	250 mL	

#### ORP Test and Pretreatment Solution Sachets

Code	Description	Size	Package	Certificate of Analysis
HI70022P	470 mV ORP solution for platinum and gold electrodes	20 mL	25 pcs.	•
HI700224P	470 mV ORP solution for platinum and gold electrodes	20 mL (Pool Line)	25 pcs.	•

#### Sample Preparation Solution Bottles

Code	Description	Size
HI7051M	soil sample preparation solution	230 mL
HI7051L	soil sample preparation solution	500 mL
HI70960	preparation solution for solid or semi-solid samples	30 mL



## Electrode Storage Solutions

- Designed for storing any pH or ORP electrode
- Special formulation
  - Special formulation to minimize microbial growth and osmotic/diffusion effects between the solution and inner reference electrolyte
- Expiration date
  - The production batch number and expiration date are reported on all Hanna calibration solutions.



- Air-tight bottles
  - Air-tight bottle with tamper-proof seal of freshness to ensure quality.
- Single use sachets
  - Opaque packaging prevents oxidation from UV light that could alter the value. Every sachet is as fresh as the day it was packaged.
- FDA compliant bottles (HI803xx)
  - Hanna solutions are offered in opaque bottles that meet FDA requirements.

HI70300 is a storage solution prepared with reagent grade chemicals that can be used to ensure optimum performance of your pH and ORP electrodes.

To ensure an optimum response time, the glass sensor tip and the reference junction of the pH electrode should be kept moist and not be allowed to dry out when not in use.

Placing the pH electrode in a small glass filled with storage solution or replacing the solution in the protective cap is a suitable way to store the electrode. Storage solution should also be used to rehydrate the electrode after a cleaning procedure by soaking for at least one hour before taking measurements.



### Electrode Storage Solutions

Code	Description	Package
HI70300L	storage solution for pH and ORP electrodes	500 mL bottle
HI703004L	storage solution for pH and ORP electrodes (Pool Line)	500 mL bottle
HI70300P	storage solution for pH and ORP electrodes	20 mL sachet (25)
HI7003004P	storage solution for pH and ORP electrodes (Pool Line)	20 mL sachet (25)
HI70300M	storage solution for pH and ORP electrodes	230 mL bottle
HI70300S	storage solution for pH and ORP electrodes	30 mL bottle
HI70300G	storage solution for pH and ORP electrodes (GroLine®)	20 mL sachet (25)
HI70300-050	storage solution for pH and ORP electrodes (GroLine)	500 mL bottle
HI70300-023	storage solution for pH and ORP electrodes (GroLine)	230 mL bottle
HI70300-012	storage solution for pH and ORP electrodes (GroLine)	120 mL bottle
HI80300L	storage solution for pH and ORP electrodes	500 mL FDA bottle
HI80300M	storage solution for pH and ORP electrodes	250 mL FDA bottle
HI5300-12	storage solution for pH and ORP electrodes	120 mL bottle



## Electrode Cleaning Solutions for a Top Performing Sensor

- **Expiration date**
  - The production batch number and expiration date are reported on all Hanna calibration solutions.
- **Air-tight bottles**
  - Air-tight bottle with tamper-proof seal of freshness to ensure quality.
- **Single use sachets**
  - Opaque packaging prevents oxidation from UV light that could alter the value. Every sachet is as fresh as the day it was packaged.
- **FDA compliant bottles (HI80xx)**
  - Hanna solutions are offered in opaque bottles that meet FDA requirements.

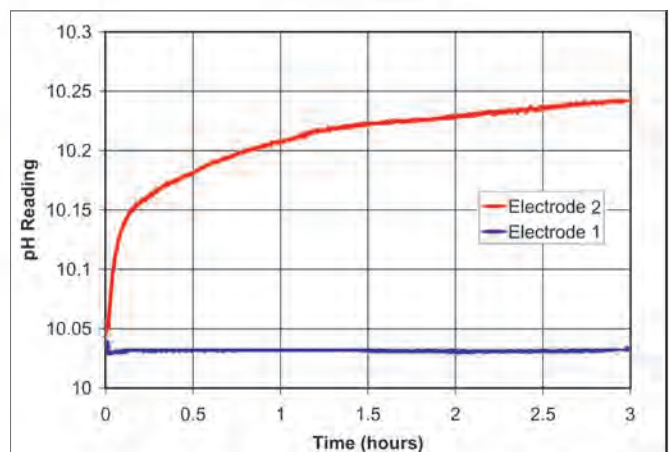

Electrode 1 has been properly cleaned before calibration.  
Electrode 2 has not been properly cleaned.

Electrodes can become dirty from use and will produce inaccurate results even as they read correctly in a pH buffer. Hanna's cleaning solutions eliminate impurities and residues that are left on electrode surfaces when immersed in samples during measurement and stored incorrectly. Hanna suggests cleaning the bulb and junction of your electrode on a regular basis to ensure that the probe is always clean and prevent any clogging of the junction.

## General Use Electrode Cleaning Solutions - Bottles

Code	Application	Package
HI7061M	general purpose	230 mL bottle
HI7061L	general purpose	500 mL bottle
HI70614L	general purpose (Pool Line)	500 mL bottle
HI7061-050	general purpose (GroLine®)	500 mL bottle
HI7061-023	general purpose (GroLine)	230 mL bottle
HI7061-012	general purpose (GroLine)	120 mL bottle
HI7073L	proteins	500 mL bottle
HI7073M	proteins	250 mL bottle
HI7074L	inorganic substances	500 mL bottle
HI7074M	inorganic substances	250 mL bottle
HI7077L	oil and fats	500 mL bottle
HI7077M	oil and fats	250 mL bottle
HI70774L	pools and spas (Pool Line)	500 mL bottle
HI8061L	general purpose	500 mL FDA bottle
HI8073L	proteins	500 mL FDA bottle
HI8077L	oil and fats	500 mL FDA bottle



## Specific Electrode Cleaning Solutions - Bottles

Code	Description	Size
HI70621L	cleaning Solution for skin grease and sebum (Cosmetic Industry)	500 mL
HI70630L	acid cleaning solution for meat grease and fats (food industry)	500 mL
HI70631L	alkaline cleaning solution for meat grease and fats (food industry)	500 mL
HI70632L	cleaning and disinfection solution for blood products	500 mL
HI70635L	cleaning solution for wine deposits (winemaking)	500 mL
HI70636L	cleaning solution for wine stains (winemaking)	500 mL
HI70640L	cleaning solution for milk deposits (food industry)	500 mL
HI70641L	cleaning and disinfection solution for dairy products (food industry)	500 mL
HI70642L	cleaning solution for cheese deposits (food industry)	500 mL
HI70643L	cleaning and disinfection solution for yogurt products (food industry)	500 mL
HI70663L	cleaning solution for soil deposits (agriculture)	500 mL
HI70664L	cleaning solution for humus deposits (agriculture)	500 mL
HI70670L	cleaning solution for salt deposits (industrial processes)	500 mL
HI70671L	cleaning and disinfection solution for algae, fungi and bacteria (industrial processes)	500 mL
HI70681L	cleaning solution for ink stains	500 mL
HI70682L	cleaning solution for brewing deposits	500 mL



## General Use Electrode Cleaning Solutions - Sachets

Code	Application	Package
HI70000P	rinsing	20 mL sachet (25)
HI700601P	general purpose	20 mL sachet (25)
HI7006014P	general purpose (Pool Line)	20 mL sachet (25)
HI70061G	general purpose (GroLine)	20 mL sachet (25)

## Specific Electrode Cleaning Solutions - Sachets

Code	Description	Qty/Size
HI700620P	cleaning Solution for skin residuals	20 mL (25)
HI700621P	cleaning Solution for skin grease and sebum (Cosmetic Industry)	20 mL (25)
HI700630P	acid cleaning solution for meat grease and fats (food industry)	20 mL (25)
HI700635P	cleaning solution for wine deposits (winemaking)	20 mL (25)
HI700636P	cleaning solution for wine stains (winemaking)	20 mL (25)
HI700640P	cleaning solution for milk deposits (food industry)	20 mL (25)
HI700641P	cleaning and disinfection solution for dairy products (food industry)	20 mL (25)
HI700642P	cleaning solution for cheese deposits (food industry)	20 mL (25)
HI700643P	cleaning and disinfection solution for yogurt products (food industry)	20 mL (25)
HI700661P	general purpose cleaning solution for agriculture	20 mL (25)
HI700663P	cleaning solution for soil deposits (agriculture)	20 mL (25)
HI700664P	cleaning solution for humus deposits (agriculture)	20 mL (25)
HI700670P	cleaning solution for salt deposits (industrial processes)	20 mL (25)
HI700671P	cleaning and disinfection solution for algae, fungi and bacteria (industrial processes)	20 mL (25)
HI700680P	cleaning solution for cellulose deposits	20 mL (25)
HI700682P	cleaning solution for beer and wort (beermaking)	20 mL (25)
HI700683P	cleaning solution for sushi rice deposits	20 mL (25)
HI700684P	cleaning solution for bread and dough deposits	20 mL (25)
HI700685P	cleaning solution for chocolate deposits	20 mL (25)

## Electrode Fill Solutions

- **Expiration date**
  - The production batch number and expiration date are reported on all Hanna calibration solutions.



- **Air-tight bottles**
  - Air-tight bottle with tamper-proof seal of freshness to ensure quality.
- **FDA compliant bottles (HI80xx)**
  - Hanna solutions are offered in opaque bottles that meet FDA requirements.

The electrolyte level in refillable electrodes should be checked before performing any measurements. If the level is low, refill with the proper electrolyte solution to ensure optimum performance. This simple maintenance helps guarantee adequate head pressure to promote the flow of reference electrolyte into the sample being measured.



### Electrode Fill Solutions

Code	Description	Package
HI7071	3.5M KCl with AgCl reference electrolyte	30 mL bottle (4)
HI7071M	3.5M KCl with AgCl reference electrolyte	250 mL bottle
HI7071L	3.5M KCl with AgCl reference electrolyte	500 mL bottle
HI7072	1M potassium nitrate electrode fill solution	30 mL bottle (4)
HI7072L	1M potassium nitrate electrode fill solution	500 mL bottle
HI7075	1.7M potassium nitrate, 0.7M potassium chloride electrode fill solution	30 mL bottle (4)
HI7076	1M sodium chloride electrode fill solution	30 mL bottle (4)
HI7078	0.5M ammonium sulfate electrode fill solution	30 mL bottle (4)
HI7082	3.5M KCl reference electrolyte for double junction electrodes	30 mL bottle (4)
HI7082M	3.5M KCl reference electrolyte for double junction electrodes	250 mL bottle
HI7082L	3.5M KCl reference electrolyte for double junction electrodes	460 mL bottle
HI8071	3.5M KCl with AgCl reference electrolyte	30 mL FDA bottle (4)
HI8082	3.5M KCl reference electrolyte for double junction	30 mL FDA bottle (4)
HI8093	1M KCl with AgCl reference electrolyte	30 mL FDA bottle (4)
HI9071	gelled bridge electrolyte for FC2053 pH electrode and HI981030 GroLine® pH tester	30 mL bottle

### Accessories

Code	Description
HI740155P	Capillary Pipette for Electrode refilling (20 pcs)







Introduction..... 3.2  
 Comparison Guides..... 3.4  
 Sensor Reference Chart.....3.5

Benchtop .....3.6

Portable.....3.16  
 pH/ORP/ISE ..... 3.16  
 Pool Line ..... 3.20

Sensors..... 3.22

Solutions and  
 Accessories .....3.28

## Three Methods of Analysis

Potentiometric ion analyses with ion-selective electrodes (ISEs) are performed by use of one of three methods, each entailing its own advantages: direct potentiometry, incremental methods, and potentiometric titration. Hanna offers a solution for each of these methods.

### Direct Potentiometry

Direct potentiometry is a widely used method of performing ion analysis with ISEs. This method is highly effective when the user must quickly measure large batches of samples at varying concentrations. Our direct reading meters, such as the HI98191, display concentration of the unknown sample by a direct reading after calibration of the instrument with two or more standards; ionic strength adjustments are made to both samples and standards. In some applications, quick and reliable measurements can be made on-site without taking samples back to the laboratory.

### Incremental Methods

Incremental methods are useful techniques used to determine ion concentration in samples whose constituents are variable or concentrated. Incremental methods have some inherent advantages over direct potentiometry. The techniques can reduce errors from variables such as temperature, viscosity, pH or ionic strength. The electrodes remain immersed throughout the process, thus reducing sample carry over and possible liquid junction changes in the reference. Known addition, known subtraction, analyte addition, and analyte subtraction methods are four of these incremental techniques. All four techniques involve adding a standard to the sample, or sample to the standard; the meter then calculates the ion concentration of the sample.

### Potentiometric Titration

A potentiometric titration can increase the precision of ISE measurements and also the number of ionic species that can be determined. ISEs are commonly used as indicators for the titrant or sample species to follow the progress of a precipitation or complexometric titration. A small change in reactant addition corresponds to a large change in electrode potential at the stoichiometric endpoint. An example of a precipitation titration is the determination of chloride using silver nitrate. A silver ISE can be used to follow this titration. A complexometric titration is used for the determination of calcium. A calcium solution is titrated with the complexing agent, EDTA. During the titration there is a gradual decrease in the free  $\text{Ca}^{2+}$  ion concentration as more EDTA is added. The endpoint corresponds to the point at which all of the  $\text{Ca}^{2+}$  is complexed. The progress of this titration can be monitored using a calcium ISE.

## Ion Selective Electrode Types

Hanna's ISEs can be grouped into three general categories based upon construction.

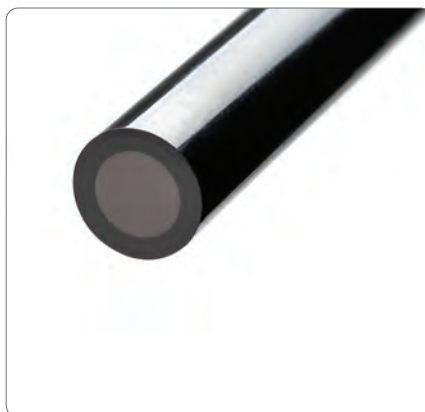

### Solid-state

Solid-state electrodes are available as both single half-cells or as combination electrodes complete with reference electrode. These electrodes incorporate a solid sensing surface made of compressed silver halides or solid crystalline material. Hanna's offering includes sensors for the determination of bromide, cadmium, chloride, cupric, cyanide, fluoride, iodide, lead and silver ions. Rugged, solid body construction ensures a long life.

Theory: A solid-state electrode develops a voltage due to ion-exchange occurring between the sample and the inorganic membrane. An equilibrium mechanism occurs due to the very limited solubility of the membrane material in the sample.



### Liquid Membrane

Liquid membrane electrodes are available as single half-cells or as combination electrodes complete with reference electrode. The sensing surfaces of these electrodes are comprised of a homogeneous polymer matrix containing organic ion exchangers that are selective for the determined ion. These sensors incorporate easily replaceable membrane modules and are available for measurements of nitrate, potassium and calcium.

Theory: The potassium electrode was one of the earliest liquid membrane sensors developed. The membrane is usually in the form of a thin disc of PVC impregnated with the antibiotic valinomycin. The exchanger, also known as an ionophore, is a ring structure that fits potassium ions inside, functioning as a lock and key mechanism. This type of membrane is not as rugged as the solid-state type so they are designed for easy replacement of the sensing module.



### Gas Membrane

Gas sensors are combination electrodes that detect dissolved gases in a solution. No external reference is required for these electrodes. The sensing element is separated from the sample solution by a gas permeable membrane. Hanna's offering of gas membrane ISEs include ammonia and carbon dioxide.

**Theory:** A gas sensor works due to the partial pressure of the measured gas in solution. The dissolved gas in the sample diffuses into the membrane and changes the pH in a thin film of unbuffered electrolyte on the surface of the internal pH sensor. Diffusion continues until the partial pressure of the sample and the thin film of electrolyte are the same. The pH change is proportional to the dissolved gas in the sample.

## Reference and Combination Electrodes

Hanna's reference electrode is used with our half-cell ISE sensors to provide accurate and repeatable measurements. Hanna's combination electrodes incorporate the measuring electrode with the reference, making them ideal for field measurements.



### Reference

Reference electrodes are used to provide a stable voltage and electrolytic contact to measure a voltage gradient across a measurement membrane. Hanna has designed an easy to use, durable, double junction, quick-fill, sleeve-style reference electrode with a cone style junction to work with the ISE family of sensors. The design forms the liquid junction with the test solution at the tip of the junction cone, producing a highly stable reference electrode with reasonable, low flow rates. The model HI5315 is a silver/silver chloride half-cell with a permanent gel-filled internal cell. The outer fill solution is easily replaceable and serves as a buffer zone between the internal chloride ion-containing gel and the sample solution. Hanna offers a complete line of silver-free fill solutions to optimize your ion measurement. A fast responding liquid junction, excellent reproducibility, and ease of use will mark this reference as your "best" in the lab.

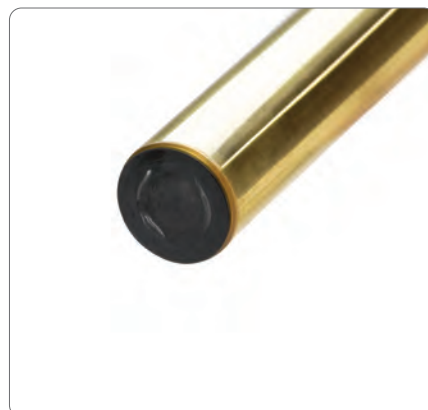

### Combination

Combination electrodes include a sensor and reference electrode within one electrode body. Our combination ISEs provide the same selectivity and response as our ISE half-cells, but include our superior double junction reference in the same electrode body. Combination solid-state electrodes have a built-in solid-state sensor and quick refillable reference electrode. Our liquid membrane and fluoride combination electrodes have replaceable module construction and the Hanna double junction reference stability.

## Benchtop Meters

	pH Range	ISE Range	ORP Range/Relative mV	EC/TDS/Salinity Range	Resistivity Range	Temperature Range	(D)irect/(I)ncremental Measurement	ISE Calibration Points	ISE Buffers: Standard/Custom	pH CAL Check™	Temperature Compensation: (A)utomatic or (M)anual	GLP	(A)uto, (L)og on demand and Auto(E)nd Data Logging	HOLD	Predefined ISE electrode	Built-in Dot Matrix Printer	PC Connection	On-screen Help, Tutorial and Multi-language	Application Designed	Page
HI5522	•	•	•	•	•	°C/°F	D,I	5	8/5	•	A/M	•	A, L, E	•	•	USB	•	research	3.6	
HI5222	•	•	•			°C/°F	D,I	5	8/5	•	A/M	•	A, L, E	•	•	USB	•	research	3.12	

## Portable Meters

	pH Range	ISE Range	ORP Range/Relative mV	EC/TDS/Salinity Range	Resistivity Range	Temperature Range	(D)irect/(I)ncremental Measurement	ISE Calibration Points	ISE: Standard/Custom	pH CAL Check	Temperature Compensation: (A)utomatic or (M)anual	GLP	(A)uto, (L)og on demand and Auto(E)nd Data Logging	HOLD	Predefined ISE electrode	PC Connection	On-screen Help, Tutorial and Multi-language	Application Designed	Page
HI981914	•	•	•			°C/°F	D	5	7/5	•	A/M	•	A, L, E	•	•	USB	•	Pool Line	3.20
HI98191	•	•	•			°C/°F	D	5	7/5	•	A/M	•	A, L, E	•	•	USB	•	universal	3.16

# Ion Selective Sensors and Accessories Reference Chart

Electrode	Type	Half-Cell	Combination	Ionic Strength Adjusters (ISA) 500 mL bottle	Silver Free Reference Fill Solutions (4) 30 mL bottles	ISE Standards 1, 500 mL bottle	ISE Standards 2, 500 mL bottle	ISE Standards 3, 500 mL bottle	Other
Ammonia	gas	–	HI4101	HI4001-00	HI4001-40	HI4001-01 0.1 M	HI4001-02 100 mg/L (ppm)	HI4001-03 1000 mg/L (ppm)	HI4000-52 replacement cap HI4001-51 membrane kit HI4000-51 replacement pH internal and cap for ammonia HI4001-45 conditioning solution HI4000-47 4 and 7 pH buffers with chloride ions background HI740159 plastic tweezers
Bromide	solid	HI4002	HI4102	HI4000-00	HI7072, 1 M KNO <sub>3</sub>	HI4002-01, 0.1 M			HI4000-70 polishing strip
Cadmium	solid	HI4003	HI4103	HI4000-00	HI7072, 1 M KNO <sub>3</sub>	HI4003-01 0.1 M			HI4000-70 polishing strip
Calcium	polymer membrane	HI4004	HI4104	HI4004-00	HI7082, 3.5 M KCl	HI4004-01, 0.1 M			HI4004-51 module HI4104-51 module for combination HI4004-45 conditioning solution
Carbon Dioxide	gas	–	HI4105	HI4005-00	HI4005-40	HI4005-01, 0.1 M	HI4005-03, 1000 mg/L (ppm) CO <sub>2</sub> as CaCO <sub>3</sub>		HI4000-54 replacement pH internal and cap for CO <sub>2</sub> HI4005-53 CO <sub>2</sub> membrane kit (3 pack) HI4000-47 4 and 7 pH buffers with chloride background HI4005-45 conditioning solution HI740159 plastic tweezers
Chloride	solid	HI4007	HI4107	HI4000-00	HI7072, 1 M KNO <sub>3</sub>	HI4007-01, 0.1 M	HI4007-02, 100 mg/L (ppm)	HI4007-03, 1000 mg/L (ppm)	HI4000-70 polishing strip
Cupric	solid	HI4008	HI4108	HI4000-00	HI7072, 1 M KNO <sub>3</sub>	HI4008-01, 0.1 M			HI4000-70 polishing strip
Cyanide	solid	HI4009	HI4109	HI4001-00	HI7072, 1 M KNO <sub>3</sub>				HI4000-70 polishing strip
Fluoride	solid	HI4010	HI4110	HI4010-00 HI4010-05 HI4010-06 HI4010-30, TISAB II, 1 ppm TISAB II, 10 ppm TISAB II	HI7075, 1 M KNO <sub>3</sub> , 0.7 M KCl	HI4010-01, 0.1 M	HI4010-02, 100 mg/L (ppm)	HI4010-03, 1000 mg/L (ppm)	HI4010-11 1 ppm with TISAB II HI4010-12 2 ppm with TISAB II HI4010-10 10 ppm with TISAB II HI4110-51 module for combination HI4010-30 fluoride measurement kit
Iodide	solid	HI4011	HI4111	HI4000-00	HI7072, 1 M KNO <sub>3</sub>	HI4011-01, 0.1 M			HI4000-70 polishing strip
Lead/ Sulfate	solid	HI4012	HI4112	HI4012-00	HI7072, 1 M KNO <sub>3</sub>	HI4012-01, lead, 0.1 M HI4012-21 sulfate, 0.1 M			HI4000-70 polishing strip
Nitrate	polymer membrane	HI4013	HI4113	HI4013-00	HI7078, (NH <sub>4</sub> ) <sub>2</sub> SO <sub>4</sub> 0.5 M	HI4013-01, 0.1 M	HI4013-02, 100 mg/L (ppm) nitrate-nitrogen	HI4013-03, 1000 mg/L (ppm) nitrate-nitrogen	HI4013-51 module HI4013-53 module (3 pack) HI4113-51 module for combination HI4113-53 module for combination (3 pack) HI4013-06 interferent suppressant ISA
Potassium	polymer membrane	HI4014	HI4114	HI4014-00	HI7076, 1 M NaCl	HI4014-01, 0.1 M			HI4014-51 module HI4114-51 module for combination
Silver/ Sulfide	solid	HI4015	HI4115	HI4000-00 (Ag <sup>+</sup> ) HI4015-00 (S <sup>2-</sup> )	HI7072, 1 M KNO <sub>3</sub>	HI4015-01, 0.1 M Ag <sup>+</sup>			HI4000-70 polishing strip
Sodium	–	FC300		HI4016-00	HI7079, 2 M NH <sub>4</sub> Cl + AgCl	HI4016-01, 0.1 M	HI4016-02, 100 mg/L (ppm)	HI4016-03, 1000 mg/L (ppm)	HI4016-10, 10 mg/L (ppm) HI4016-45 storage solution HI4016-46 conditioning solution
Reference		HI5315			HI7072, 1 M KNO <sub>3</sub> HI7076, 1 M NaCl HI7078, (NH <sub>4</sub> ) <sub>2</sub> SO <sub>4</sub> HI7082, 3.5 M KCl HI7075, 1.7 M KNO <sub>3</sub> , 0.7 M KCl				

## Research Grade Meter

pH/ORP/ISE and EC/TDS/Resistivity/Salinity  
and Temperature



The HI5522 is an advanced research grade benchtop pH/ORP/ISE and EC/TDS/Salinity/Resistivity meter that is completely customizable with a large color LCD, capacitive touch keys, and USB port for computer connectivity.

The HI5522 is a two-channel meter that allows for simultaneous measure of pH, ORP, or ISE on one channel and EC, TDS, Salinity, or Resistivity on the other. Channel one has a BNC connection for use with the expansive line of pH, ORP, and ISE electrodes that Hanna Instruments offers. The meter is supplied with the HI1131B glass body, double junction, combination pH electrode that operates over a wide temperature range from 0 to 100°C. All readings are automatically compensated for temperature variations with the separate HI7662-T temperature probe or from the built-in temperature sensor of the conductivity probe on Channel two. The HI5522 is supplied with the HI76312 four-ring conductivity probe that operates over a wide range

from 0.000  $\mu\text{S}/\text{cm}$  to 1000.0  $\text{mS}/\text{cm}^*$ . The meter can be set to auto-ranging in which the meter chooses the appropriate conductivity range from seven ranges or fixed range in which the meter will only display reading in  $\mu\text{S}/\text{cm}$  or  $\text{mS}/\text{cm}$ . All readings are automatically compensated for temperature variations with a built in temperature sensor. The temperature correction coefficient is adjustable from 0.00 to 10.00  $\%/^{\circ}\text{C}$ .

As a pH meter the HI5522 can be calibrated up to five points with a choice of eight pre-programmed buffers or five custom buffers. The HI5522 features Hanna's exclusive CAL Check™ to alert the user of potential problems during the pH calibration process. Indicators displayed during calibration include "Electrode Dirty/Broken" and "Buffer Contaminated." The overall probe condition based on the offset and slope characteristic of the electrode is displayed as a percentage after calibration is complete.

In ISE mode the HI5522 can be calibrated up to five points with a choice of five fixed standards or five user defined in any concentration unit. The calibration data including date, time, standards used and slope can be viewed at any time along with the current measurement by selecting the Good Laboratory Practice (GLP) display option.

As an EC/TDS/Salinity/Resistivity meter the HI5522 can be calibrated up to four points with a choice of six pre-programmed conductivity standards or user defined custom standards. Resistivity, TDS, Practical Salinity (PSU) and Natural Seawater Scale are calibrated through conductivity. The % NaCl is calibrated to single point with the HI7037 salinity standard. The calibration data including date, time, and standards used, offset and cell factor can be accessed at any time

along with the current measurement by selecting the Good Laboratory Practice (GLP) display option.

For the measurement of high purity water used in pharmaceutical manufacturing, the HI5522 is programmed with the three stages of the USP <645> method. Once a stage is met a report is generated and can be saved. Up to 200 reports can be stored and transferred to a Windows® compatible computer using the supplied USB cable and software.

Three selectable logging modes are available: automatic, manual and AutoHold logging. Up to 100,000 data points can be recorded in 100 lots with 50,000 records max/lot on each channel and exported to a computer for data review and storage.

## Customizable User Interface

The user interface of the HI5522 allows the user to show measurements in various modes: basic measurement with or without GLP information, real-time graphing, and logging data. Calibration stability criteria can be adjusted from fast, moderate, and accurate. Programmable alarm limits can be set to inside or outside allowable limits.

## Color Graphic LCD

The HI5522 features a color graphic LCD with on-screen help, graphic, and custom color configurations. The display allows for real-time graphing and the use of virtual keys provide for an intuitive user interface.

## Capacitive Touch

The HI5522 features sensitive capacitive touch buttons for accurate keystrokes when navigating menus and screens. There are four dedicated keys that are used for routine operations including calibration and switching measurement modes and four virtual keys that change based upon use. The capacitive touch technology ensures the buttons never get clogged with sample residue.

## Four Ring Conductivity Probe

All readings are performed with the HI76312 four-ring conductivity probe that has a built in temperature sensor for automatic temperature correction. The four rings are made with platinum and the body of the electrode is made of Polyetherimide (PEI) plastic that is resistant to many harsh chemicals. The four-ring design allows for this probe to be used over a wide range of measurements.

## Choice of Calibration

Automatic buffer recognition, semiautomatic, and direct manual entry pH calibration options are available for calibrating up to five points, from a selection of eight standard buffers and up to five custom buffers. For the conductivity channel the calibration can be set to automatic standard recognition or user entry along with a choice of single or multi-point. Calibration can be performed up to four points when multi-point is selected.

## CAL Check™

CAL Check alerts users to potential problems during the calibration of the pH electrode. Indicators include "Electrode Dirty/Broken," "Buffer Contaminated," electrode response time and the overall probe condition as a percentage that is based on the offset and slope characteristics.

## GLP Data

HI5522 includes a GLP feature that allows users to view calibration data and calibration expiration information at the touch of a key. Calibration data include date, time, standards used for calibration.

## ISE Measurement with Choice of Concentration Units

The HI5522 allows for calibration and readings in choice of concentration units. The choices of concentration units include ppt, g/L, mg/mL, ppm, mg/L, µg/L, ppb, µg/L, mg/mL, M, mol/L, mmol/L, %w/v and a user-defined unit.

## ISE Measurement with Incremental Methods

The known addition, known subtraction, analyte addition, and analyte subtraction incremental methods are pre-programmed into the HI5522. Simply follow the on screen guided procedure and the meter will perform the calculation automatically allowing for a higher level of accuracy to be obtained as compared to a direct ISE measurement.

## Data Logging

Three selectable logging modes are available on the HI5522: automatic, manual, and AutoHold logging. Automatic and manual logs up to 100 lots with 50,000 records max/lot, with up to 100,000 total data points. Automatic logging features the option to save data according to sampling period and interval.

## Data Transfer

Data can be transferred to a PC with USB cable and HI92000 software (both sold separately).

## Contextual Help

Contextual help is always available through a dedicated "HELP" key. Clear tutorial messages and directions are available on-screen to quickly and easily guide users through setup and calibration. The help information displayed is relative to the setting/option being viewed.

## pH and EC Features

### pH CAL Check™

Proper calibration of the pH electrode system is critical in order to achieve reliable results. Hanna's exclusive CAL Check system includes several features to help users reach that goal.

- Each time a pH calibration is performed, the instrument compares the new calibration with the previous one. When this comparison indicates a significant difference, the message alerts the user to either clean the electrode, check the buffer or both.
- When measurements are taken too far from the calibration points, the instrument will warn the user with a message on the LCD.
- The condition of the pH electrode after calibration is shown on the display, as well as the date and time.
- To avoid taking readings with old calibrations, the instrument automatically reminds the user when the calibration has expired.

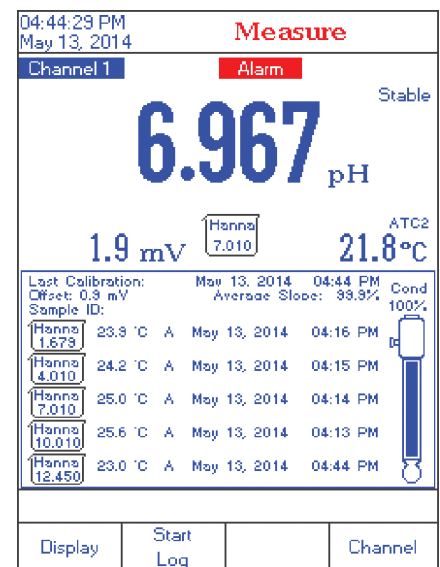
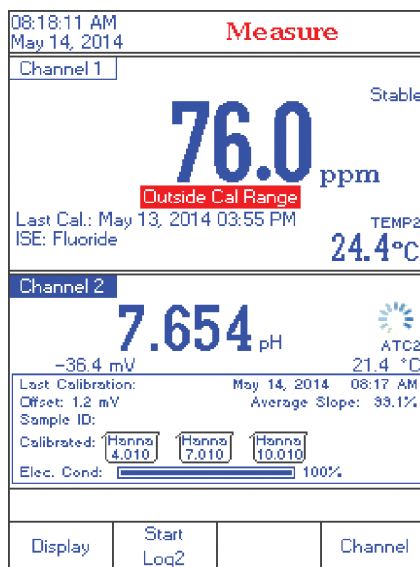
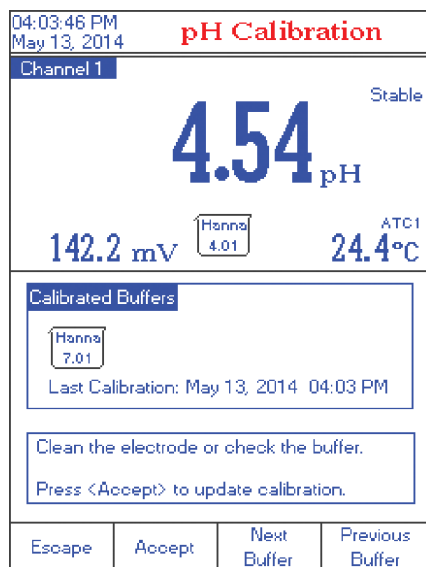

### EC USP Mode

Hanna's HI5522 and HI5521 together with EC probes can be used for conductivity measurements required to prepare water for injection (WFI) according to USP <645>.

The instruments give clear instructions on how to perform each stage and automatically check that the temperature, conductivity and stability are within USP limits.

Comprehensive results are shown on a single screen at the end of the test. Up to 200 reports can be saved for future recall.

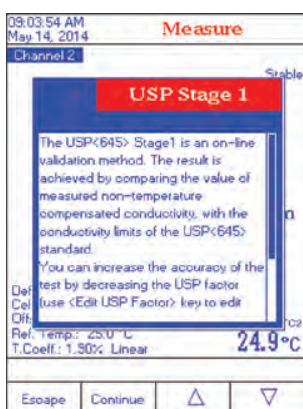



## ISE Features

### ISE Incremental Methods

Ion concentration determinations with ISEs can be made faster and easier using the streamlined incremental methods.

Incremental methods involve adding a standard to a sample or sample to a standard and detecting the mV change that occurs due to the addition, and this difference determines the concentration. Historically the user would use mathematical equations to determine the ion concentration of the sample; the HI5522, sample concentrations are calculated automatically and then logged into an ISE method report; up to 200 reports can be saved for future recall. The entire process can be repeated on multiple samples without reentering sets of parameters. Reports can be printed using HI92000 PC software.

Incremental method techniques can reduce errors from variables such as temperature, viscosity, pH or ionic strength. The electrodes remain immersed throughout the process, thus reducing measurement time as well as eliminating sample carry over and its associated errors.

Known Addition, Known Subtraction, Analyte Addition, and Analyte Subtraction methods are standard method choices provided by the HI5522.

08:05:39 AM May 14, 2014		Known Subtraction	
Channel 1		14.8 mV	Stable TEMP1 22.4 °C
First Step First Reading			
Manual Edit			
Sample Vol.	100.000	mL	
ISA Vol.	2.000	mL	
Std. Vol.	10.000	mL	
Std. Conc.	100	ppm	
Stoich. Factor	1.0		
then press <Continue>.			
Escape	Edit	Next	Previous

#### First Step

The first step in performing an incremental method analysis is to enter the required parameters including sample, ISA and standard volumes, as well as standard concentration and stoichiometric factor.

When repeating the analysis on another sample, the parameters do not need to be reentered.

08:09:43 AM May 14, 2014		Known Addition	
Channel 1		10.5 mV	Stable TEMP1 21.7 °C
First Step First Reading			
Second Step Second Reading			
Sample Volume:	100.000	mL	
ISA Buffer Vol. :	2.000	mL	
Reagent Volume:	2.000	mL	
Reagent Conc.:	1000	ppm	
Press <Read> to memorize the current reading and to pass to the next method step.			
Escape	Read		

#### Sequence of Readings

Once the variables are entered, the user is guided step-by-step through the measurement process.

The initial mV measurement is made before the addition; next is the addition, followed by the second mV measurement.

08:11:14 AM May 14, 2014		ISE Results	
Channel 1		35.9 ppm	
Sample ID:			
Calculated Slope:	100.1 %		
Reading 1:	10.5 mV		
Reading 2:	-0.4 mV		
Sample Volume:	100.000	mL	
Reagent Volume:	2.000	mL	
ISA Volume:	2.000	mL	
Reagent Conc.:	1000	ppm	
Press <Direct Measure> to return in main measurement panel. Press <Save> to log the current results.			
Direct Measure	Save	Edit	Start KA

#### Results

The results are automatically calculated and shown together with all the parameters used.

At this time, results can be saved into an ISE Methods Report and printed using the HI92000 PC software.



- **Low Profile**
  - HI5522 features a low profile with an ideal viewing angle

## Additional Features by Screen

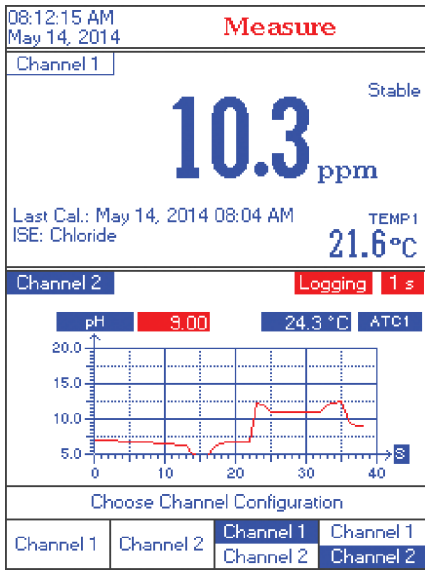

Channel Configuration

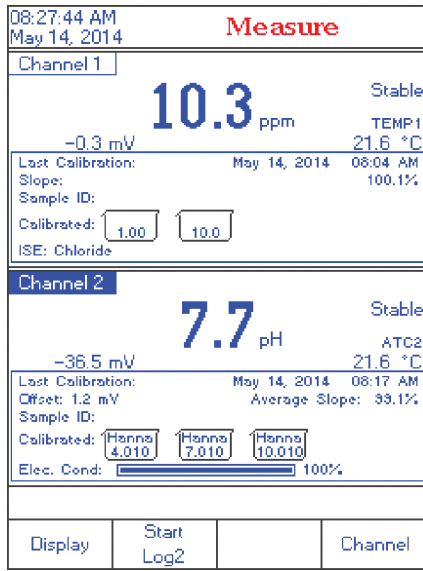

Good Laboratory Practices

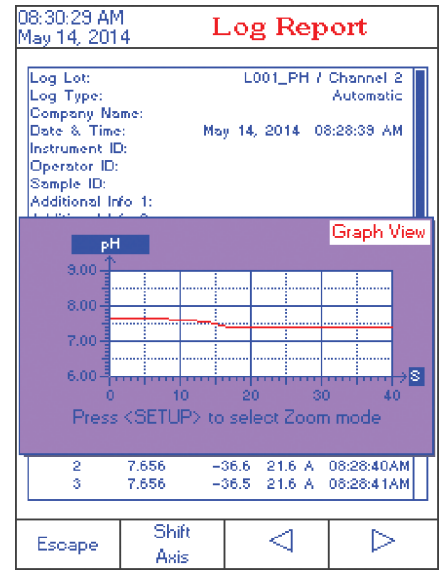

Log Recall

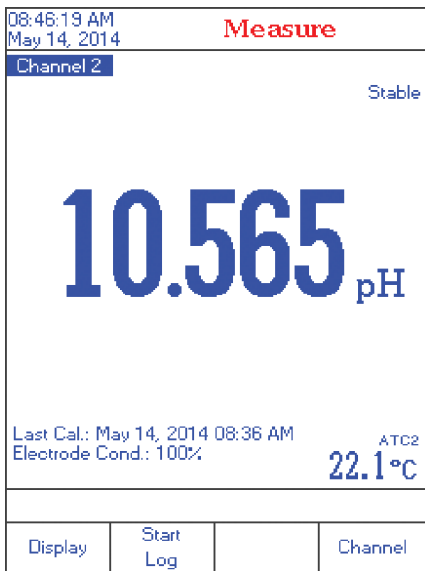

Basic Display

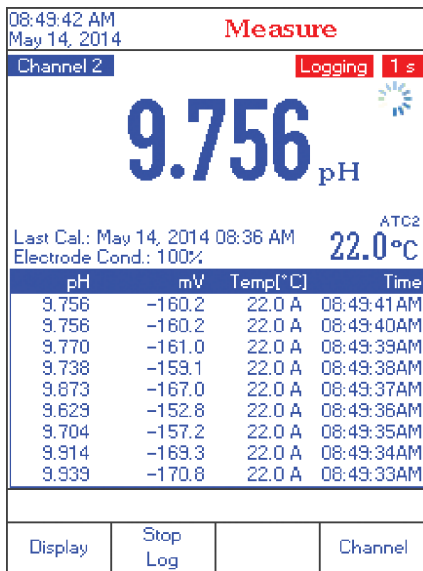

Real-Time Logging

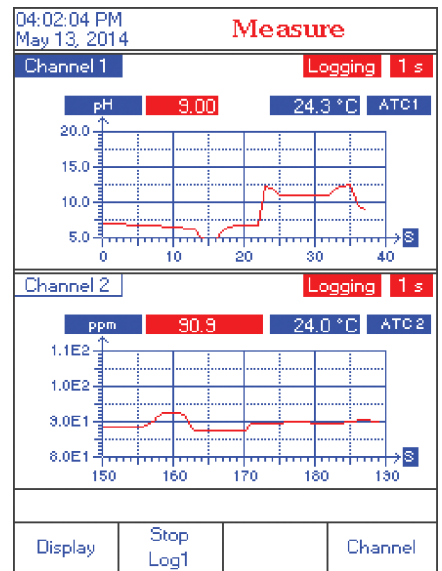

Simultaneous Dual Channel Graphing



### Dual Channels

The two measurement channels of the HI5522 are galvanically isolated to eliminate noise and instability.

In ISE mode, this instrument provides a choice of several incremental methods. Communication is via opto-isolated USB.

Specifications	HI5522	
pH	Range	-2.0 to 20.0 pH; -2.00 to 20.00; -2.000 to 20.000 pH
	Resolution	0.1 pH; 0.01 pH; 0.001 pH
	Accuracy	±0.1 pH; ±0.01 pH; ±0.002 pH ±1 LSD
	Calibration	automatic, up to five-point calibration, eight standard buffers available (1.68, 3.00, 4.01, 6.86, 7.01, 9.18, 10.01, 12.45), and five custom buffers
	Temperature Compensation	automatic or manual from -20.0 to 120.0°C/-4.0 to 248.0°F/253.15 to 393.15K
mV	Range	±2000 mV
	Resolution	0.1 mV
	Accuracy	±0.2 mV ±1 LSD
ISE	Range	1 x 10 <sup>-6</sup> to 9.99 x 10 <sup>10</sup> concentration
	Resolution	1; 0.1; 0.01; 0.001 concentration
	Accuracy	±0.5% (monovalent ions); ±1% (divalent ions)
	Calibration	automatic, up to five-point calibration, five fixed standard solutions available for each measurement unit, and five user defined standards
Temperature**	Range	-20.0 to 120°C; -4.0 to 248.0°F; 253.15 to 393.15K
	Resolution	0.1°C; 0.1°F; 0.1K
	Accuracy	±0.2°C; ±0.4°F; ±0.2K (without probe)
EC	Range	0.000 to 9.999 µS/cm; 10.00 to 99.99 µS/cm; 100.0 to 999.9 µS/cm; 1.000 to 9.999 mS/cm; 10.00 to 99.99 mS/cm; 100.0 to 1000.0 mS/cm absolute EC*
	Resolution	0.001 µS/cm; 0.01 µS/cm; 0.1 µS/cm; 0.001 mS/cm; 0.01 mS/cm; 0.1 mS/cm
	Accuracy	±1% of reading (±0.01 µS/cm)
	Cell Constant	0.0500 to 200.00
	Cell Type	4-pole cell
	Calibration	automatic standard recognition, user standard single point / multi-point calibration
	Calibration Reminder	yes
	Temperature Coefficient	0.00 to 10.00 %/°C
	Temperature Compensation	disabled, linear and non-linear (natural water)
	Reference Temperature	5.0 to 30.0°C
	Profiles	up to 10, 5 each channel
	USP Compliant	yes
	TDS	Range
Resolution		0.001 ppm; 0.01 ppm; 0.1 ppm; 0.001 ppt; 0.01 ppt; 0.1 ppt
Accuracy		±1% of reading (±0.01 ppm)
Resistivity	Range	1.0 to 99.9 Ω•cm; 100 to 999 Ω•cm; 1.00 to 9.99 kΩ•cm; 10.0 to 99.9 kΩ•cm; 100 to 999 kΩ•cm; 1.00 to 9.99 MΩ•cm; 10.0 to 100.0 MΩ•cm
	Resolution	0.1 Ω•cm; 1 Ω•cm; 0.01 kΩ•cm; 0.1 kΩ•cm; 1 kΩ•cm; 0.01 MΩ•cm; 0.1 MΩ•cm
	Accuracy	±2% of reading (±1 Ω•cm)
Salinity	Range	practical scale: 0.00 to 42.00 psu; natural sea water scale: 0.00 to 80.00 ppt; percent scale: 0.0 to 400.0%
	Resolution	0.01 for practical scale/natural sea water scale; 0.1% for percent scale
	Accuracy	±1% of reading
	Calibration	percent scale—one point (with HI7037 standard); all others through EC
Additional Specifications	pH Electrode	HI1131B glass body pH electrode with BNC connector and 1 m (3.3') cable (included)
	EC Probe	HI76312 platinum, four-ring EC/TDS probe with and 1 m (3.3') cable (included)
	Temperature Probe	HI7662-W stainless steel temperature probe with 1 m (3.3') cable (included)
	Input Channel(s)	1 pH/ORP/ISE + 1 EC
	GLP	cell constant, reference temperature/coefficient, calibration points, cal time stamp, probe offset for conductivity
	Logging	<b>record:</b> Up to 100 lots, 50,000 records max/lot / maximum 100,000 data points/channel; <b>interval:</b> 14 selectable between 1 second and 180 minutes; <b>type:</b> automatic, manual, AutoHOLD; <b>additional:</b> 200 records USP; 200 records incremental methods
	PC Connection	USB
	Power Supply	12 VDC adapter (included)
	Environment	0 to 50°C (32 to 122°F; 273 to 323K) RH max 95% non-condensing
Dimensions / Weight	160 x 231 x 94 mm (6.3 x 9.1 x 3.7") / 1.2 kg (2.64 lbs.)	
Ordering Information	<b>HI5522-01</b> (115V) and <b>HI5522-02</b> (230V) are supplied with HI1131B pH electrode, HI76312 EC/TDS probe, HI7662-W temperature probe, pH 4.01 buffer solution sachet (2), pH 7.01 buffer solution sachet (2), pH 10.01 buffer solution sachet (2), 1413 µS/cm conductivity standard sachet (2), 12880 µS/cm conductivity standard sachet (2), HI700601 electrode cleaning solution sachet (2), HI7082 3.5M KCl electrolyte solution (30 mL), HI76404W electrode holder, 12 VDC adapter, capillary dropper pipette, quality certificate, quick start guide and instruction manual.	

(\*) Uncompensated conductivity (or TDS) is the conductivity (or TDS) value without temperature compensation.  
(\*\*) Reduced to actual probe limits

# Research Grade Meter

pH/ORP/ISE and Temperature



The HI5222 is an advanced research grade benchtop pH/mV/ISE dual channel meter that is completely customizable with a large color LCD, capacitive touch keys, and USB port for computer connectivity.

The HI5222 features two galvanically isolated BNC connections for use with the expansive line of pH, ISE and ORP electrodes that Hanna Instruments offers. The meter is supplied with the HI1131B glass body, double junction, combination pH electrode that operates over a wide range of temperature from 0 to 100°C. All readings are automatically compensated for temperature variations with the separate HI7662-T temperature probe that is included.

As a pH meter the HI5222 can be calibrated up to five points with eight pre-programmed buffers or five custom buffers. The HI5222 features Hanna's exclusive CAL Check™ to alert the user of potential problems during the pH calibration process. Indicators displayed

during calibration include "Electrode Dirty/Broken" and "Buffer Contaminated." The overall probe condition based on the offset and slope characteristic of the electrode is displayed as a percentage after calibration is complete.

As an ISE meter the HI5222 can be calibrated up to five points with a choice of seven fixed standards or five user defined in any concentration unit. The calibration data including date, time, standards used and slope can be viewed at any time along with the current measurement by selecting the Good Laboratory Practice (GLP) display option.

Three selectable logging modes are available: automatic, manual and AutoHold logging. Up to 100,000 data points per channel can be recorded in 100 lots, 50,000 records max/lot and exported to a computer for data review and storage.

## Customizable User Interface

The user interface of the HI5222 allows the user to show measurements in various modes: basic measurement with or without GLP information, real-time graphing, and logging data. Calibration stability criteria can be adjusted from fast, moderate, and accurate. Programmable alarm limits can be set to inside or outside allowable limits.

## Color Graphic LCD

The HI5222 features a color graphic LCD with on-screen help, graphic, and custom color configurations. The display allows for real-time graphing and the use of virtual keys provide for an intuitive user interface.

## Capacitive Touch

The HI5222 features sensitive capacitive touch buttons for accurate keystrokes when navigating menus and screens. There are four dedicated keys that are used for routine operations including calibration and switching measurement modes and four virtual keys that change based upon use. The capacitive touch technology ensures the buttons never get clogged with sample residue.

## Two Galvanically Isolated pH/ORP/ISE Channels

The HI5222 has two input channels that can be used for pH, ORP and ISE electrodes. Each input channel has connectors for BNC probes, reference probes and a temperature sensor. Each channel is galvanically isolated which

means that two measurement probes can be in the same solution at the same time and the voltages produced will not interfere with each other.

## Choice of Calibration

Automatic buffer recognition, semi automatic, and direct manual entry pH calibration options are available for calibrating up to five points, from a selection of eight standard buffers and up to five custom buffers.

## GLP Data

HI5222 includes a GLP Feature that allows users to view calibration data and calibration expiration information at the touch of a key. Calibration data include date, time, buffers used for calibration, and electrode offset and slope characteristics.

## CAL Check™

CAL Check alerts users to potential problems during the calibration of the pH electrode. Indicators include "Electrode Dirty/Broken," "Buffer Contaminated," electrode response time and the overall probe condition as a percentage that is based on the offset and slope characteristics.

## ISE Measurement with Choice of Concentration Units

The HI5222 allows for calibration and readings in choice of concentration units. The choices of concentration units include ppt, g/L, mg/mL, ppm, mg/L, µg/mL, ppb, µg/L, mg/mL, M, mol/L, mmol/L, %w/v and a user-defined unit.

## ISE Measurement with Incremental Methods

The known addition, known subtraction, analyte addition, and analyte subtraction incremental methods are pre-programmed into the HI5222. Simply follow the on screen guided procedure and the meter will perform the calculation automatically allowing for a higher level of accuracy to be obtained as compared to a direct ISE measurement.

## Data Logging

Three selectable logging modes are available on the HI5222: automatic, manual, and AutoHold logging. Automatic and manual logs up to 100 lots with 50,000 records max/lot with up to 100,000 total data points per channel. Automatic logging features the option to save data according to sampling period and interval.

## Data Transfer

Data can be transferred to a PC with USB cable and HI92000 software (both sold separately).

## Contextual Help

Contextual help is always available through a dedicated "HELP" key. Clear tutorial messages and directions are available on-screen to quickly and easily guide users through setup and calibration. The help information displayed is relative to the setting/option being viewed.

## CAL Check Screens

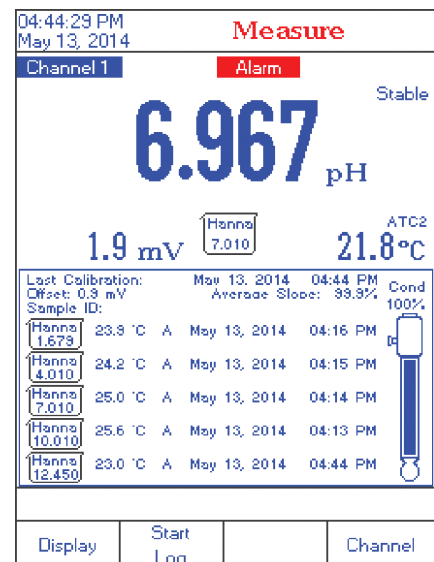
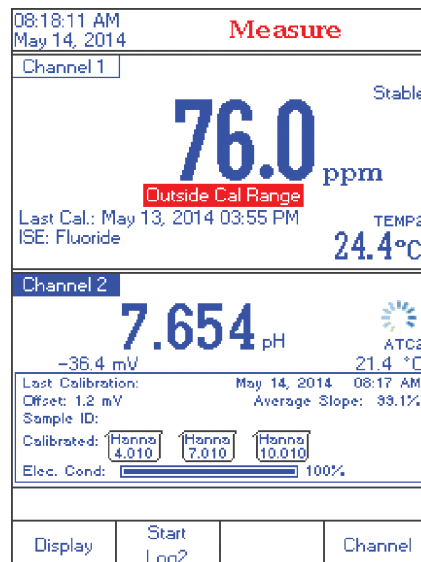
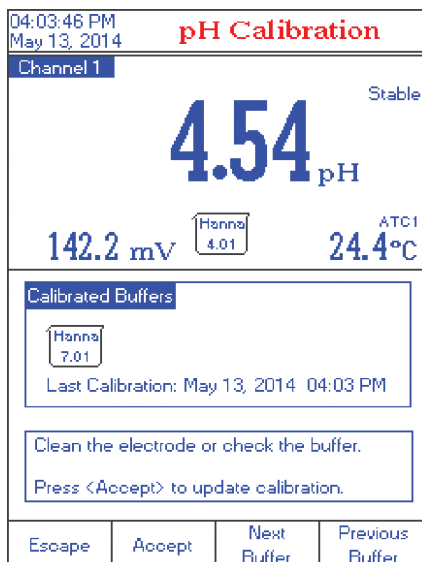

## Additional Features by Screen

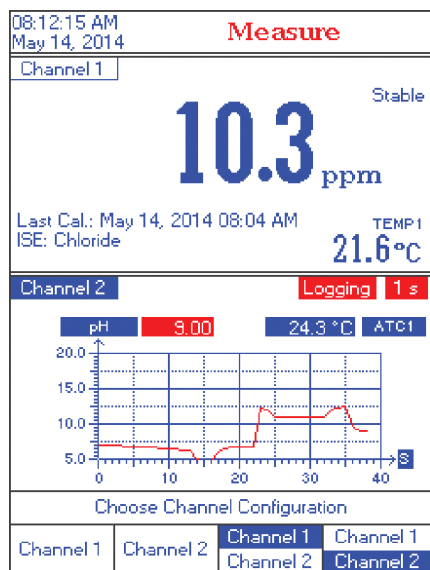

Channel Configuration

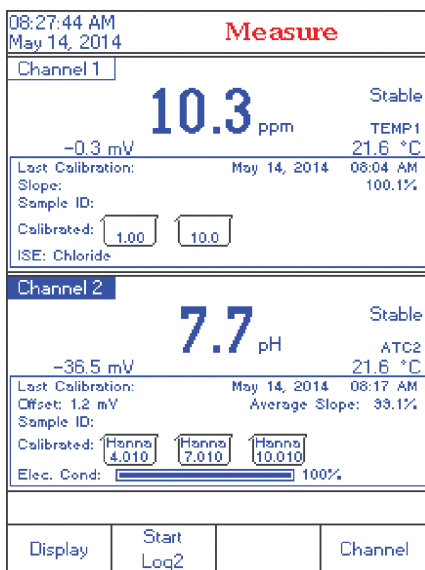

Good Laboratory Practices

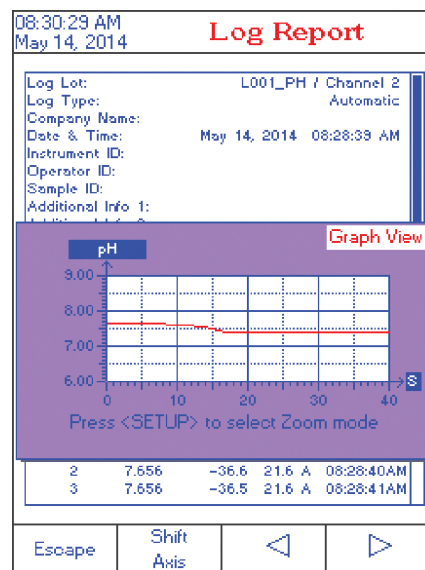

Log Recall

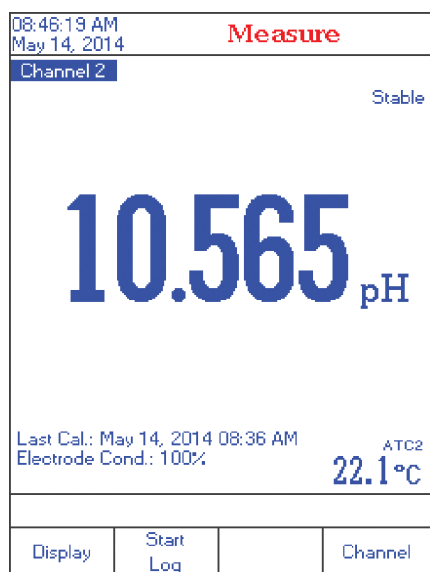

Basic Display

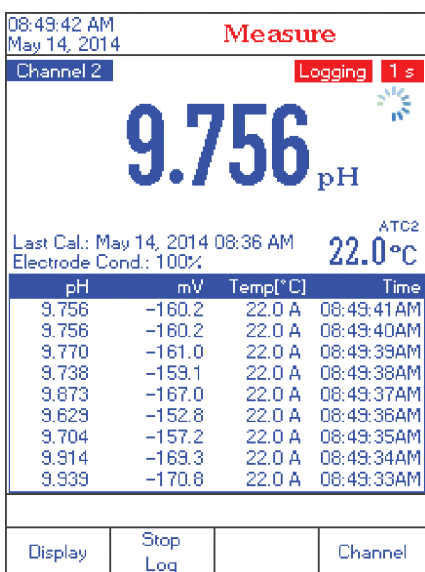

Real-Time Logging

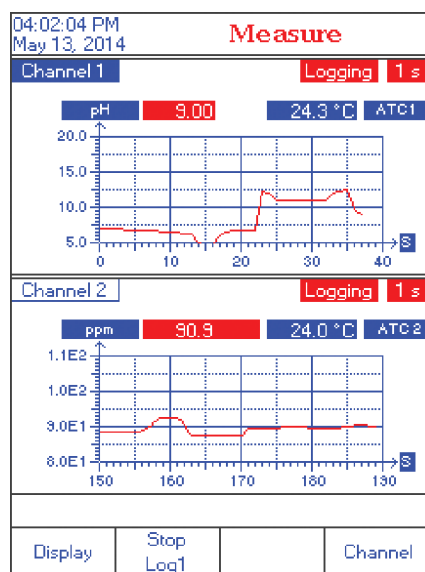

Simultaneous Dual Channel Graphing



## Dual Channels

The two measurement channels of the HI5222 are galvanically isolated to eliminate noise and instability.

In ISE mode, this instrument provides a choice of several incremental methods. Communication is via opto-isolated USB.



## Specifications

## HI5222

pH	Range	-2.0 to 20.0 pH; -2.00 to 20.00; -2.000 to 20.000 pH
	Resolution	0.1 pH; 0.01 pH; 0.001 pH
	Accuracy	±0.1 pH; ±0.01 pH; ±0.002 pH ±1 LSD
	Calibration	automatic, up to five point calibration, eight standard buffers available (1.68, 3.00, 4.01, 6.86, 7.01, 9.18, 10.01, 12.45), and five custom buffers
	Temperature Compensation	automatic or manual from -20.0 to 120.0°C/-4.0 to 248.0°F/253.15 to 393.15K
mV	Range	±2000 mV
	Resolution	0.1 mV
	Accuracy	±0.2 mV ±1 LSD
	Relative mV Offset Range	±2000 mV
ISE	Range	1 x 10 <sup>-6</sup> to 9.99 x 10 <sup>10</sup> concentration
	Resolution	1; 0.1; 0.01; 0.001 concentration
	Accuracy	±0.5% (monovalent ions); ±1% (divalent ions)
	Calibration	automatic, up to five-point calibration, seven fixed standard solutions available for each measurement unit, and five user defined standards
Temperature*	Range	-20.0 to 120°C; -4.0 to 248.0°F; 253.15 to 393.15K
	Resolution	0.1°C; 0.1°F; 0.1K
	Accuracy	±0.2°C; ±0.4°F; ±0.2K
Additional Specifications	pH Electrode	HI1131B glass body pH electrode with BNC connector and 1 m (3.3') cable (included)
	Temperature Probe	HI7662-W stainless steel temperature probe with 1 m (3.3') cable (included)
	Input Channel(s)	2 pH/ORP/ISE
	GLP	calibration points, calibration time stamp, probe offset, slope, date, time and buffers/standards used
	Logging	<b>record</b> : Up to 100 lots, 50,000 records max/lot / maximum 100,000 data points/channel; <b>interval</b> : 14 selectable between 1 second and 180 minutes; <b>type</b> : automatic, manual, AutoHOLD;
	Display	color graphic LCD 240x340 pixels
	PC Connection	USB
	Power Supply	12 VDC adapter (included)
	Environment	0 to 50°C (32 to 122°F; 273 to 323K) RH max 95% non-condensing
	Dimensions	160 x 231 x 94 mm (6.3 x 9.1 x 3.7")
Weight	1.2 kg (2.64 lbs.)	
Ordering Information	<b>HI5222-01</b> (115V) and <b>HI5222-02</b> (230V) are supplied with HI1131B pH electrode, HI7662-W temperature probe, pH 4.01 buffer solution sachet (2), pH 7.01 buffer solution sachet (2), HI700601 electrode cleaning solution sachet (2), HI7082 3.5M KCl electrolyte solution (30 mL), HI76404W electrode holder, 12 VDC adapter, capillary dropper pipette, quality certificate, quick start guide and instruction manual. <b>HI5222-03</b> includes the above without electrode.	

(\*) Reduced to actual probe limits

HI98191

# Professional Waterproof Meter

pH/ORP/ISE

- **ISE measurement units**
  - Extensive choice of units to display readings (ppm, ppt, g/L, µg/L, mg/L, M, mol/L, mmol/L, %, w/v, user)
- **Waterproof**
  - IP67 rated waterproof, rugged enclosure
- **CAL Check™**
  - Alerts users to problems during pH calibration including dirty/broken electrode, contaminated buffer and overall probe condition
- **Automatic or manual temperature compensation**
  - pH sensors incorporate a built-in temperature sensor
- **Calibration**
  - Up to a five-point pH calibration with seven standard buffers and five custom buffers available
- **Approximately 200 hour battery life**
  - Powered by (4) 1.5V AA batteries
- **Clear display**
  - Dot matrix display with multifunction virtual keys
- **AutoHold**
  - Automatically holds the first stable reading on the display
- **Calibration timeout**
  - Alerts when calibration is due at a specified interval
- **Connectivity**
  - PC connectivity via opto-isolated micro-USB with HI92000 software
- **GLP**
  - GLP data provides data from previous calibration to ensure Good Laboratory Practices are met
- **Intuitive keypad**
  - Most of the available options such as GLP information, help, range, calibration and backlight have a dedicated button
- **Supplied complete**
  - Each meter is supplied complete with sensor, calibration solution, beakers, PC software and connection cable, instruction manual, quick start guide and batteries in a rugged, custom carrying case.



## Designed for professionals

The HI98191 is a rugged, portable pH/ORP/ISE meter with the performance and features of a benchtop meter. Exchange out the pH probe for an ORP probe to obtain mV readings in the  $\pm 2000$  mV range. This professional, waterproof meter can easily be operated with one hand and complies with IP67 standards. The HI98191 is supplied with all necessary accessories to perform a pH/temperature measurement packaged into a durable carrying case.





### Backlit Graphic LCD Display

The HI98191 features a backlit graphic LCD with on-screen help. The graphic display allows for the use of virtual keys to provide for an intuitive user interface.

### Waterproof Protection

The meter is enclosed in an IP67 rated waterproof casing and can withstand immersion in water at a depth of 1 m for up to 30 minutes. The probe features an IP68 rating for continuous immersion in water.

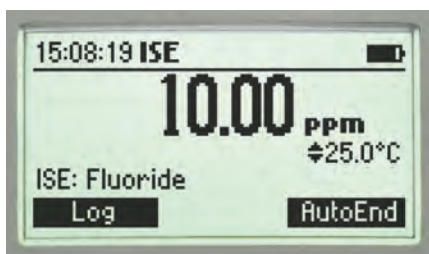

### ISE Sensors and Calibration

HI98191 has 17 different standard ISE sensors pre-programmed in the meter. Selecting the appropriate sensor will automatically update the ion charge for slope calibration and can be calibrated up to five points with the choice of seven standards and five custom standards (choice of units). This meter allows an extensive choice of measurement units (ppm, ppt, g/L, ppb, µg/L, mg/mL, M, mol/L, mmol/L, % w/v, user) and has an expanded measuring range of  $1.00 \times 10^{-7}$  to  $9.99 \times 10^{10}$ .

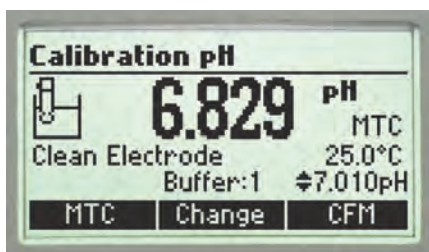

### pH Calibration

Choose from seven standard pH buffers and five custom pH buffers to obtain up to five point calibration and achieve high precision readings with a pH accuracy of  $\pm 0.002$  and up to  $\pm 0.001$  pH resolution.

### Enhanced Calibration

An "Out of Calibration Range" warning can be engaged to keep the user informed of the current calibration and help to avoid performing measurements that are out of range.

### CAL Check™

Hanna's CAL Check maintains a history of past calibrations and monitors the pH electrode and buffers during subsequent calibrations for any signs of wide variances due to a dirty or broken electrode or contaminated pH buffers. During calibration, users are alerted to problems should they occur. After calibration, the electrode's overall condition is displayed as a percentage.

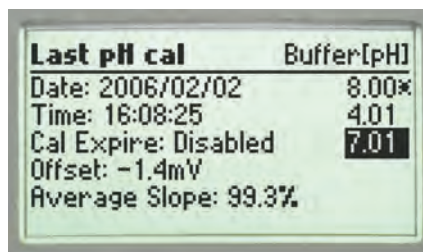

### GLP

Comprehensive GLP functions are directly accessible by pressing the GLP key. Calibration data, including date, time and calibration values are stored for retrieval at a later time.

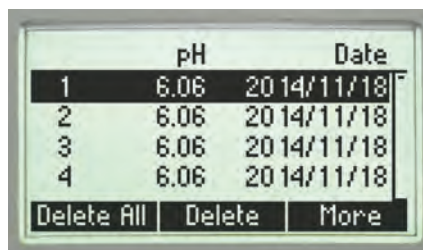

### Data Logging

The log-on-demand feature allows users to store up to 300 samples that can be later transferred to a PC with the HI920015 USB cable and HI92000 software.

### Intuitive Keypad

The fitted rubber keypad has dedicated keys for power, backlight, up/down arrows, help and alphanumeric characters. The meter also features two virtual soft keys that navigate the user through the configuration of each parameter, meter setup, and logging of data. The interface is intuitive for any user's level of experience.

### AutoHold

Pressing AutoHold during measurement will automatically hold the first stable reading on the display.

### Dedicated Help Key

Contextual help is always available through a dedicated "HELP" key. Clear tutorial messages and directions are available on-screen to quickly and easily guide users through setup and calibration. The help information displayed is relative to the setting/option being viewed.

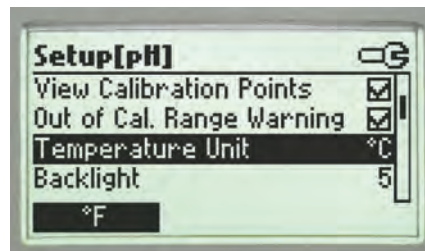

### Setup screen

Our extensive setup screen features a host of configurable options such as time, date, temperature units and language for help screens and guides.

### PC Connectivity

Logged data can be transferred to a Windows compatible PC with the included HI920015 micro USB cable and HI92000 software.

### Long Battery Life

The display of the meter has a battery icon indicator to show the remaining power. The meter uses four 1.5V AA batteries that provide up to 200 hours of battery life.



### Rugged Custom Carrying Case

The HI98191 meter, probe, and all accessories are supplied in the HI720191 rugged carrying case designed to provide years of use. The inside compartment of the carrying case is thermoformed to securely hold and protect all of the components.





## HI72911B pH Electrode

- Titanium body
  - Titanium construction provides an unbreakable structure and allows the transfer of heat to the internal temperature sensor for rapid temperature compensation
- Maintenance free, gel-filled electrode
  - No fill solution required

## Calibrate right in the case with custom beaker holders

## Next Level Ruggedness

- Optional shockproof silicon rubber boot
  - Specially designed to protect your instrument from damage or impact

**HI710034** Orange

### Specifications

### HI98191

pH*	Range	-2.0 to 20.0 pH; -2.00 to 20.00 pH; -2.000 to 20.000 pH
	Resolution	0.1 pH; 0.01 pH; 0.001 pH
	Accuracy	±0.1 pH; ±0.01 pH; ±0.002 pH
	Calibration	up to five-point calibration, seven standard buffers available (1.68, 4.01, 6.86, 7.01, 9.18, 10.01, 12.45) and five custom buffers
	Temperature Compensation	automatic or manual from -20.0 to 120.0°C (-4.0 to 248.0°F)
mV*	Range	±2000 mV
	Resolution	0.1 mV
	Accuracy	±0.2 mV
	Relative mV Offset Range	±2000 mV
ISE	Range	from 1.00 E <sup>-7</sup> to 9.99 E <sup>10</sup> concentration
	Resolution	3 digits 0.01; 0.1; 1; 10 concentration
	Accuracy	±0.5% of reading (monovalent ions), ±1% of reading (divalent ions)
	Calibration	up to five point calibration, six standard solutions available (0.1, 1, 10, 100, 1000, 10000 ppm)
Temperature*	Range	-20.0 to 120.0 °C (-4.0 to 248.0°F)
	Resolution	0.1°C (0.1°F)
	Accuracy	±0.4°C (±0.8°F) (excluding probe error)
Additional Specifications	pH Probe	HI72911B titanium body, pH electrode with internal temperature sensor, BNC connector and 1 m (3.3' cable)
	Slope Calibration	from 80 to 110%
	Log-on-demand	300 samples (100 each pH/mV/ISE range)
	PC Connection	opto-isolated USB with HI92000 software and micro USB cable
	Input Impedance	10 <sup>12</sup> Ω
	Battery Type / Life	1.5V AA batteries (4) / approximately 200 hours of continuous use without backlight (50 hours with backlight)
	Auto-off	user selectable: 5, 10, 30, 60 min, disabled
	Environment	0 to 50°C (32 to 122°F); RH 100% IP67
Dimensions / Weight	185 x 93 x 35.2 mm (7.3 x 3.6 x 1.4") / 400 g (14.2 oz.)	
Ordering Information	<p><b>HI98191</b> is supplied with HI72911B pH electrode, HI7004M pH 4.01 buffer solution (230 mL), HI7007M pH 7.01 buffer solution (230 mL), electrode cleaning solution sachet (2), 100 mL plastic beaker (2), HI92000 PC software, HI920015 micro USB cable, 1.5V AA batteries (4), quick start guide, quality certificate and instruction manual in an HI720191 rugged carrying case with custom insert.</p> <p><b>HI98191-03</b> includes the above without electrode.</p>	

\* Will be reduced to actual sensor limits

HI981914

# Professional Waterproof Meter

pH/ORP/ISE

- **ISE measurement units**
  - Extensive choice of units to display readings (ppm, ppt, g/L, µg/L, mg/L, M, mol/L, mmol/L, %, w/v, user)
- **Waterproof**
  - IP67 rated waterproof, rugged enclosure
- **CAL Check™**
  - Alerts users to problems during pH calibration including dirty/broken electrode, contaminated buffer and overall probe condition
- **Automatic or manual temperature compensation**
  - pH sensors incorporate a built-in temperature sensor
- **Calibration**
  - Up to a five-point pH calibration with seven standard buffers and five custom buffers available
- **Approximately 200 hour battery life**
  - Powered by (4) 1.5V AA batteries
- **Clear display**
  - Dot matrix display with multifunction virtual keys
- **AutoHold**
  - Automatically holds the first stable reading on the display
- **Calibration timeout**
  - Alerts when calibration is due at a specified interval
- **Connectivity**
  - PC connectivity via opto-isolated micro-USB with HI92000 software
- **GLP**
  - GLP data provides data from previous calibration to ensure Good Laboratory Practices are met
- **Intuitive keypad**
  - Most of the available options such as GLP information, help, range, calibration and backlight have a dedicated button
- **Supplied complete**
  - Each meter is supplied complete with sensor, calibration solution, beakers, PC software and connection cable, instruction manual, quick start guide and batteries in a rugged, custom carrying case.



## Waterproof Protection

The meter is enclosed in an IP67 rated waterproof casing and can withstand immersion in water at a depth of 1 m for up to 30 minutes.



## Backlit Graphic LCD Display

These meters feature a backlit graphic LCD with on-screen help. The graphic display allows for the use of virtual keys to provide for an intuitive user interface.

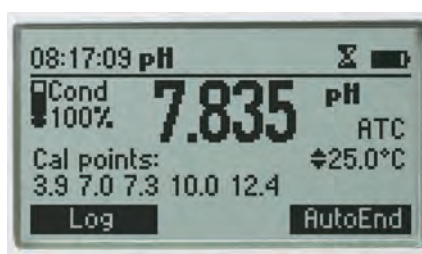

## CAL Check™

Hanna's CAL Check maintains a history of past calibrations and monitors the pH electrode and buffers during subsequent calibrations for any signs of wide variances due to a dirty or broken electrode or contaminated pH buffers. During calibration, users are alerted to problems should they occur. After calibration, the electrode's overall condition is displayed as a percentage.



## Data Logging

The log-on-demand feature allows users to store up to 200 samples that can later be transferred to a PC with the HI920015 USB cable and HI92000 software.



## HI72911B pH Electrode

- Titanium body
  - Titanium construction provides an unbreakable structure and allows the transfer of heat to the internal temperature sensor for rapid temperature compensation
- Maintenance free, gel-filled electrode
  - No fill solution required

Specifications	HI981914	
pH*	Range	-2.0 to 20.0 pH; -2.00 to 20.00 pH; -2.000 to 20.000 pH
	Resolution	0.1 pH; 0.01 pH; 0.001 pH
	Accuracy	±0.1 pH; ±0.01 pH; ±0.002 pH
	Calibration	up to five-point calibration, seven standard buffers available (1.68, 4.01, 6.86, 7.01, 9.18, 10.01, 12.45) and five custom buffers
	Temperature Compensation	automatic or manual from -20.0 to 120.0°C (-4.0 to 248.0°F)
mV*	Range	±2000 mV
	Resolution	0.1 mV
	Accuracy	±0.2 mV
	Relative mV Offset Range	±2000 mV
ISE	Range	from 1.00 E <sup>-7</sup> to 9.99 E <sup>10</sup> concentration
	Resolution	3 digits 0.01; 0.1; 1; 10 concentration
	Accuracy	±0.5% of reading (monovalent ions), ±1% of reading (divalent ions)
	Calibration	up to five point calibration, six standard solutions available (0.1, 1, 10, 100, 1000, 10000 ppm)
Temperature*	Range	-20.0 to 120.0 °C (-4.0 to 248.0°F)
	Resolution	0.1°C (0.1°F)
	Accuracy	±0.4°C (±0.8°F) (excluding probe error)
Additional Specifications	pH Probe	HI72911B titanium body, pH electrode with internal temperature sensor, BNC connector and 1 m (3.3' cable)
	Slope Calibration	from 80 to 110%
	Log-on-demand	300 samples (100 each pH/mV/ISE range)
	PC Connection	opto-isolated USB with HI92000 software and micro USB cable
	Input Impedance	10 <sup>12</sup> Ω
	Battery Type / Life	1.5V AA batteries (4) / approx. 200 hours of continuous use without backlight (50 hours with backlight)
	Auto-off	user selectable: 5, 10, 30, 60 min, disabled
	Environment	0 to 50°C (32 to 122°F); RH 100% IP67
	Dimensions / Weight	185 x 93 x 35.2 mm (7.3 x 3.6 x 1.4") / 400 g (14.2 oz.)
Ordering Information	<b>HI981914</b> is supplied with HI72911B pH electrode, HI7004M pH 4.01 buffer solution (230 mL), HI7007M pH 7.01 buffer solution (230 mL), electrode cleaning solution sachet (2), 100 mL plastic beaker (2), HI92000 PC software, HI920015 micro USB cable, 1.5V AA batteries (4), quick start guide, quality certificate and instruction manual in an HI720191 rugged carrying case with custom insert.	

# Ion Selective Electrodes

Ammonia · Bromide · Cadmium



Parameter	Ammonia	Bromide		Cadmium	
Code	<b>HI4101</b>	<b>HI4002</b>	<b>HI4102</b>	<b>HI4003</b>	<b>HI4103</b>
Type	gas-sensing; combination	solid-state; half-cell	solid-state; combination	solid-state; half-cell	solid-state; combination
Measurement Range	1M to $1 \cdot 10^{-6}$ M 17000 to 0.02 mg/L (ppm) 14000 to 0.016 mg/L as N	1M to $1 \cdot 10^{-6}$ M 79910 to 0.08 mg/L (ppm)		0.1M to $1 \cdot 10^{-7}$ M 11200 to 0.01 mg/L (ppm)	
Optimum pH Range	>11	2 to 12.5	2 to 12.5	2 to 12	2 to 12
Temperature Range	0 to 40°C	0 to 80°C	0 to 80°C	0 to 80°C	0 to 80°C
Approximate Slope	-56	-56	-56	+28	+28
Body O.D.	12 mm	12 mm	12 mm	12 mm	12 mm
Insertion Length	120 mm	120 mm	120 mm	120 mm	120 mm
Body Material	Delrin®	epoxy	PEI	epoxy	PEI
Cable	1 m coaxial	1 m coaxial	1 m coaxial	1 m coaxial	1 m coaxial
Possible Applications	determination of ammonium, ammonia in wine, beer, water, waste water and soil	plants, soils, and as an indicator for titration		electroplating, battery construction, laboratory and as an indicator for titrations	
Connection	BNC	BNC	BNC	BNC	BNC

# Ion Selective Electrodes

Calcium · Carbon Dioxide · Chloride



Parameter	Calcium		Carbon Dioxide	Chloride	
Code	<b>HI4004</b>	<b>HI4104</b>	<b>HI4105</b>	<b>HI4007</b>	<b>HI4107</b>
Type	polymer membrane; half-cell	polymer membrane; combination	gas-sensing; combination	solid-state; half-cell	solid-state; combination
Measurement Range	1M to 3·10 <sup>-6</sup> M 40080 to 0.12 mg/L (ppm)		1·10 <sup>-2</sup> M to 1·10 <sup>-4</sup> M 440 to 4.4 mg/L (ppm)	1M to 5·10 <sup>-5</sup> M 35500 to 1.8 mg/L (ppm)	
Optimum pH Range	4 to 10	4 to 10	4.2 to 5.2	2 to 11	2 to 11
Temperature Range	0 to 40°C	0 to 40°C	0 to 40°C	0 to 80°C	0 to 80°C
Approximate Slope	+28	+28	+54	-56	-56
Body O.D.	12 mm	12 mm	12 mm	12 mm	12 mm
Insertion Length	120 mm	120 mm	120 mm	120 mm	120 mm
Body Material	epoxy/PVC	PEI/PVC	Delrin®	epoxy	PEI
Cable	1 m coaxial	1 m coaxial	1 m coaxial	1 m coaxial	1 m coaxial
Possible Applications	determination of free calcium in beverages, water, and seawater		determination of carbonates as CO <sub>2</sub> in water, soft drinks and wine samples	determination of free chloride ions in emulsified food products, beverages, plants, soils and as an indicator for titration	
Connection	BNC	BNC	BNC	BNC	BNC

# Ion Selective Electrodes

Cupric · Cyanide



Parameter	Cupric		Cyanide	
Code	<b>HI4008</b>	<b>HI4108</b>	<b>HI4009</b>	<b>HI4109</b>
Type	solid-state; half-cell	solid-state; combination	solid-state; half-cell	solid-state; combination
Measurement Range	0.1M to 1•10 <sup>-6</sup> M 6355 to 0.06 mg/L (ppm)		0.01M to 1•10 <sup>-6</sup> M 260 to 0.02 mg/L (ppm)	
Optimum pH Range	3 to 7	3 to 7	>11	>11
Temperature Range	0 to 80°C	0 to 80°C	0 to 80°C	0 to 80°C
Approximate Slope	+27	+27	-56	-56
Body O.D.	12 mm	12 mm	12 mm	12 mm
Insertion Length	120 mm	120 mm	120 mm	120 mm
Body Material	epoxy	PEI	epoxy	PEI
Cable	1 m coaxial	1 m coaxial	1 m coaxial	1 m coaxial
Possible Applications	used as an indicator for titrations using chelates		determination of free cyanide ions in plating baths, waste water and in plant and soil samples	
Connection	BNC	BNC	BNC	BNC



# Ion Selective Electrodes

Fluoride · Iodide



Parameter	Fluoride			Iodide	
Code	HI4010	HI4110	FC301B	HI4011	HI4111
Type	solid-state; half-cell	solid-state; combination	solid-state; half-cell	solid-state; half-cell	solid-state; combination
Measurement Range	1M to 1•10 <sup>-6</sup> M Sat. to 0.02 mg/L (ppm)			1M to 1•10 <sup>-7</sup> M 127000 to 0.01 mg/L (ppm)	
Optimum pH Range	5 to 8	5 to 8	5 to 8	2 to 13	2 to 13
Temperature Range	0 to 80°C	0 to 80°C	0 to 80°C	0 to 80°C	0 to 80°C
Approximate Slope	-56	-56	-56	-56	-56
Body O.D.	12 mm	12 mm	12 mm	12 mm	12 mm
Insertion Length	120 mm	120 mm	120 mm	120 mm	120 mm
Body Material	epoxy	PEI/epoxy	epoxy	epoxy	PEI
Cable	1 m coaxial	1 m coaxial	1 m coaxial	1 m coaxial	1 m coaxial
Possible Applications	determination of free fluoride in potable water, soft drinks, wine, plants, emulsified food products, plating and pickling acids			determination of free iodide ions in emulsified food samples (iodized table salt), plants and for titration	
Connection	BNC	BNC	BNC	BNC	BNC

HI4012 · HI4112 · HI4013 · HI4113 · HI4014 · HI4114

# Ion Selective Electrodes

Lead/Sulfate · Nitrate · Potassium



Parameter	Lead/Sulfate		Nitrate		Potassium	
Code	HI4012	HI4112	HI4013	HI4113	HI4014	HI4114
Type	solid-state; half-cell	solid-state; combination	polymer membrane; half-cell	polymer membrane; combination	polymer membrane; half-cell	polymer membrane; combination
Measurement Range	0.1M to $1 \cdot 10^{-6}$ M 20700 to 0.21 mg/L (ppm)		1.0M to $1 \cdot 10^{-5}$ M 6200 to 0.62 mg/L (ppm) 1400 to 0.4 mg/L (ppm) as N		1.0M to $1 \cdot 10^{-6}$ M 39100 to 0.039 mg/L (ppm)	
Optimum pH Range	4 to 7	4 to 7	3.0 to 8	3.0 to 8	1.5 to 12.0	1.5 to 12.0
Temperature Range	0 to 80°C	0 to 80°C	0 to 40°C	0 to 40°C	0 to 40°C	0 to 40°C
Approximate Slope	+27	+27	-56	-56	+56	+56
Body O.D.	12 mm	12 mm	12 mm	12 mm	12 mm	12 mm
Insertion Length	120 mm	120 mm	120 mm	120 mm	120 mm	120 mm
Body Material	epoxy	PEI	epoxy/PVC	PEI/PVC	epoxy/PVC	PEI/PVC
Cable	1 m coaxial	1 m coaxial	1 m coaxial	1 m coaxial	1 m coaxial	1 m coaxial
Possible Applications	determination of lead ions in plating baths and as an indicator for titrations		determination of free nitrate in natural waters (fresh and sea), and in emulsified food and plant samples		determination of potassium ions in wine, waters, soils and biological samples	
Connection	BNC	BNC	BNC	BNC	BNC	BNC

# Ion Selective Electrodes

Silver/Sulfide · Sodium · Reference



Parameter	Silver/Sulfide		Sodium	Reference
Code	<b>HI4015</b>	<b>HI4115</b>	<b>FC300B</b>	<b>HI5315</b>
Type	solid-state; half-cell	solid-state; combination	glass combination	N/A
Measurement Range	1.0M to 1•10 <sup>-6</sup> M 107900 to 0.11ppm (Ag <sup>+</sup> ) 1.0M to 1•10 <sup>-7</sup> M 32100 to 0.003 ppm (S <sup>2-</sup> )	Ag <sup>+</sup> 1.0M to 1•10 <sup>-6</sup> M 107900 to 0.11ppm S <sup>2-</sup> 1.0M to 1•10 <sup>-7</sup> M 32100 to 0.003 ppm	1M to 1•10 <sup>-5</sup> M 22990 to 0.23 ppm	N/A
Optimum pH Range	2 to 8 (Ag <sup>+</sup> ) 12 to 14 (S <sup>2-</sup> )	Ag <sup>+</sup> 2 to 8 S = 12 to 14	9.75 to 14 pH	N/A
Temperature Range	0 to 80°C	0 to 80°C	0 to 80°C	0 to 85°C
Approximate Slope	+56 (Ag <sup>+</sup> ) / -28 (S <sup>2-</sup> )	+56 Ag <sup>+</sup> / -28 S <sup>2-</sup>	+57	N/A
Body O.D.	12 mm	12 mm	12 mm	12 mm
Insertion Length	120 mm	120 mm	120 mm	120 mm
Body Material	epoxy	PEI	glass	PEI
Cable	1 m coaxial	1 m coaxial	1 m coaxial	1 m coaxial
Possible Applications	used as an indicator for titrations using silver nitrate; for the determination of sulfide ions in waters, paper liquors, natural waters and soils.		water, soil, food products, soup, dairy, brines, soft drinks, beer, wine and laboratory	used to complete electrical circuit and to provide stable reference voltage for ISE half-cells
Connection	BNC	BNC	BNC	BNC

## ISE Standards

Our wide selection of Hanna ISE Standards are made and bottled in our own state-of-the-art solutions facility. ISE Standards are required for direct and incremental measurement techniques and are available with certificate of analysis.

Code	Description	Size
HI4001-01	0.10 M ammonia standard	500 mL
HI4001-02	100 mg/L (ppm) ammonia standard (as NH <sub>3</sub> N)	500 mL
HI4001-03	1000 mg/L (ppm) ammonia standard (as NH <sub>3</sub> N)	500 mL
HI4002-01	0.10 M bromide standard	500 mL
HI4003-01	0.10 M cadmium standard	500 mL
HI4004-01	0.10 M calcium standard	500 mL
HI4005-01	0.10 M carbon dioxide standard	500 mL
HI4005-03	1000 ppm as CaCO <sub>3</sub> carbon dioxide standard	500 mL
HI4007-01	0.10 M chloride standard	500 mL
HI4007-02	100 ppm chloride standard	500 mL
HI4007-03	1000 ppm chloride standard	500 mL
HI4008-01	0.1 M cupric standard	500 mL
HI4010-01	0.1 M fluoride standard	500 mL
HI4010-02	100 ppm fluoride standard	500 mL
HI4010-03	1000 ppm fluoride standard	500 mL
HI4010-10	10 ppm fluoride standard premixed with TISAB II	500 mL
HI4010-11	1 ppm fluoride standard premixed with TISAB II	500 mL
HI4010-12	2 ppm fluoride standard premixed with TISAB II	500 mL
HI4010-30	kit containing 4 bottles each of : HI4010-10, HI4010-11 and HI4010-00	500 mL (3 x 4)
HI4011-01	0.1 M iodide standard	500 mL
HI4012-01	0.1 M lead standard	500 mL
HI4012-21	0.1 M sulfate standard	500 mL
HI4013-01	0.1 M nitrate standard	500 mL
HI4013-02	100 ppm nitrate standard (as N)	500 mL
HI4013-03	1000 ppm nitrate standard (as N)	500 mL
HI4014-01	0.1 M potassium standard	500 mL
HI4015-01	0.1 M silver standard	500 mL
HI4016-01	0.1 M sodium standard	500 mL
HI4016-02	100 ppm sodium standard	500 mL
HI4016-03	1000 ppm sodium standard	500 mL
HI4016-10	10 ppm sodium standard	500 mL



## Gas Sensor Fill Solutions

Code	Description	Size
HI4001-40	ammonia filling solution	30 mL bottles (4)
HI4005-40	carbon dioxide filling solution	30 mL bottles (4)

## Specific Solutions for ISE Sensors

Code	Description	Size
HI4000-47	pH 4 and pH 7 buffers with chloride ions background, used to check internal glass electrode of gas sensors	10 packages each and 2 beakers
HI4001-45	conditioning and storage solution for HI4101 ammonia ISE	500 mL
HI4004-45	conditioning and storage solution for HI4004 and HI4104 calcium ISEs	500 mL
HI4005-45	conditioning and storage solution for HI4105 carbon dioxide ISE	500 mL
HI4016-45	storage solution for sodium ISE	500 mL
HI4016-46	conditioning solution for sodium ISE	500 mL



## Ionic Strength Adjusters (ISA)

Hanna Ionic Strength Adjusters (ISA) are formulated to provide a constant ionic strength in sample and standards alike, thus permitting concentration rather than activity measurements to be made. In some cases ISAs adjust pH and eliminate matrix effects.

Code	Description	Size
HI4000-00	ISA for halide ISEs	500 mL
HI4001-00	alkaline ISA for ammonia and cyanide ISEs	500 mL
HI4004-00	ISA for calcium ISEs	500 mL
HI4005-00	ISA for carbon dioxide ISEs	500 mL
HI4010-00	TISAB II for fluoride ISEs	500 mL
HI4010-05	TISAB II for fluoride ISEs	1 gallon
HI4010-06	TISAB III concentrate for fluoride ISEs	500 mL
HI4012-00	ISA for lead/sulfate ISEs	100 mL (5)
HI4013-00	ISA for nitrate ISEs	500 mL
HI4013-06	nitrate interferent suppressant ISA	500 mL
HI4014-00	ISA for potassium ISEs	500 mL
HI4015-00	SAOB (sulfide antioxidant buffer)	500 mL + 18 g (2 components)
HI4016-00	ISA for sodium ISEs	500 mL

## Silver-free Reference Fill Solutions

Recommended for our combination ISE electrodes and the Hanna HI5315 reference electrode. Reference electrodes should be topped off daily with the correct filling solution for optimum measurement performance. These solutions are silver-free to eliminate silver precipitates found with standard electrolytes.

Code	Description	Size
HI7072	electrolyte solution, 1 M $\text{KNO}_3$	30 mL bottles (4)
HI7075	electrolyte solution with $\text{KNO}_3$ and KCl	30 mL bottles (4)
HI7076	electrolyte solution, 1 M NaCl	30 mL bottles (4)
HI7078	electrolyte solution, $(\text{NH}_4)_2\text{SO}_4$	30 mL bottles (4)
HI7082	electrolyte solution, 3.5 M KCl	30 mL bottles (4)

## Reference Fill Solutions Containing Silver Chloride (AgCl)

Code	Description	Size
HI7079	2M $\text{NH}_4\text{Cl}$ sat. with AgCl electrolyte for sodium ISEs (contains AgCl)	30 mL bottles (4)



# Solutions

## Sodium (Na<sup>+</sup>) ISE Standard Solutions

Code	Description	Package
HI7080L	2.3 g/L sodium standard solution	500 mL bottle
HI7080M	2.3 g/L sodium standard solution	250 mL bottle
HI7086L	23 g/L sodium standard solution	500 mL bottle
HI7086M	23 g/L sodium standard solution	250 mL bottle
HI7087L	0.23 g/L sodium standard solution	500 mL bottle
HI7087M	0.23 g/L sodium standard solution	250 mL bottle
HI8080L	2.3 g/L sodium standard solution	500 mL FDA bottle
HI8086L	23 g/L sodium standard solution	500 mL FDA bottle
HI8087L	0.23 g/L sodium standard solution	500 mL FDA bottle

## Sodium Chloride (NaCl) Standard Solutions

Code	Description	Package
HI7037L	100% NaCl Calibration Solution for Seawater Salinity (100% NaCl)	500 mL bottle
HI7037M	100% NaCl Calibration Solution for Seawater Salinity (100% NaCl)	230 mL bottle
HI7081/1L	standard solution at 30 g/L sodium chloride	1 L bottle
HI7081L	standard solution at 30 g/L sodium chloride	500 mL bottle
HI7081M	standard solution at 30 g/L sodium chloride	250 mL bottle
HI7083L	standard solution at 3.0 g/L sodium chloride	500 mL bottle
HI7083M	standard solution at 3.0 g/L sodium chloride	250 mL bottle
HI7084L	standard solution at 58.4 g/L sodium chloride	500 mL bottle
HI7084M	standard solution at 58.4 g/L sodium chloride	250 mL bottle
HI7085L	standard solution at 0.3 g/L sodium chloride	500 mL bottle
HI7085M	standard solution at 0.3 g/L sodium chloride	250 mL bottle
HI7088L	standard solution at 5.84 g/L sodium chloride	500 mL bottle
HI7088M	standard solution at 5.84 g/L sodium chloride	250 mL bottle
HI7089L	standard solution at 125 g/L sodium chloride	500 mL bottle
HI7089M	standard solution at 125 g/L sodium chloride	250 mL bottle
HI7090L	ISA solution for sodium ISE	500 mL bottle
HI7090M	ISA solution for sodium ISE	250 mL bottle
HI8088L	standard solution at 5.84 g/L sodium chloride	500 mL FDA bottle

The sodium and sodium chloride standard solutions are used for the calibration of pocket-sized, portable and bench salinity meters, as well as for the sodium ISE.

These solutions are available in 230 or 500 mL bottles, and also in opaque bottles that meet the FDA (Food & Drug Administration) specifications, in 230 or 500 mL volumes.

Fluoride standard solutions are used to calibrate all instruments that measure fluoride using a fluoride ISE. Additional fluoride standards are found on page 4.28

Both sodium/sodium chloride and fluoride solutions are available with a certificate of analysis on request.

## Fluoride Standard Solutions

Code	Description	Bottle
HI7023/1L	TISAB Solution	1 L
HI7023L	TISAB Solution	500 mL
HI7023M	TISAB Solution	250 mL
HI70701/1L	standard solution at 1 g/L F <sup>-</sup>	1 L
HI70701L	standard solution at 1 g/L F <sup>-</sup>	500 mL
HI70701M	standard solution at 1 g/L F <sup>-</sup>	250 mL
HI70702/1L	standard solution at 10 mg/L F <sup>-</sup>	1 L
HI70702L	standard solution at 10 mg/L F <sup>-</sup>	500 mL
HI70702M	standard solution at 10 mg/L F <sup>-</sup>	250 mL
HI70703/1L	standard solution at 100 mg/L F <sup>-</sup>	1 L
HI70703L	standard solution at 100 mg/L F <sup>-</sup>	500 mL
HI70703M	standard solution at 100 mg/L F <sup>-</sup>	250 mL

## Accessories

HI4000-50	liquid membrane sensor handle
HI4000-51	gas sensor replacement pH for ammonia sensor
HI4000-52	gas sensor membrane cap for ammonia
HI4000-54	gas sensor replacement pH for carbon dioxide ISE
HI4000-70	halide polishing strips (24)
HI4001-51	ammonia membrane kit (20 loose)
HI4004-51	calcium module for HI4004 half-cell ISE
HI4104-51	calcium module for HI4104 combination ISE
HI4005-53	carbon dioxide membrane kit (3 caps)
HI4110-51	fluoride module for HI4110 combination ISE
HI4013-51	nitrate module for HI4013 half-cell ISE
HI4013-53	nitrate module for HI4013 half-cell ISE (3 pack)
HI4113-51	nitrate module for HI4113 combination ISE
HI4113-53	nitrate module for HI4113 combination ISE (3 pack)
HI4014-51	potassium module for HI 4014 half-cell ISE
HI4114-51	potassium module for combination ISE
HI740159	plastic tweezers



**Introduction..... 4.2**

- Product Spotlights..... 4.4
- Comparison Guides..... 4.5

**Titration Systems ..... 4.6**

- HI932 Automatic Titration System ..... 4.6
- HI922 Autosampler ..... 4.12
- HI931 Automatic Titration System..... 4.16
- HI933 Karl Fischer Volumetric ..... 4.22
- HI934 Karl Fischer Coulometric..... 4.26
- Photometric Electrodes..... 4.30
- HI921 Autosampler..... 4.32
- HI901W Automatic Titration System for Wine..... 4.36
- Total Titratable Acidity for Vinegar ..... 4.40
- Total Titratable Acidity for Water ..... 4.42
- Total Titratable Alkalinity for Water ..... 4.44
- Titratable Acidity for Dairy Products ..... 4.46
- Titratable Acidity for Fruit Juice..... 4.48

- Formol Number for Wine and Fruit Juice..... 4.50
- Sulfur Dioxide for Wine..... 4.52
- Titratable Acidity for Wine ..... 4.54

**Titration Solutions and Reagents ..... 4.56**

**Meter Specific Accessories and Reagents..... 4.57**

Titration is used in analytical chemistry to determine the amount or concentration of a substance, known as the analyte. Titration is a quantitative measurement of an analyte in solution by its complete reaction with a reagent. In a titration, one reagent (the titrant) is slowly added to a solution containing the species being measured (the analyte). As it is added, a chemical reaction occurs between the titrant and analyte. The point at which the reaction is complete and an equivalent quantity of titrant and analyte are present (a stoichiometric equivalent) is called the equivalence point. This can be determined by a chemical indicator that is also present in the solution, or by a measurable physical change in the solution, like pH, electrode potential, conductivity, or light absorption (color). In practice, an abrupt change of this physical property signals the end of titration, called the endpoint.

The purpose of titration is to determine the quantity or concentration of an analyte with a known concentration and volume of a titrant. Titrations are based on chemical reactions which must fulfill four requirements:

- The reaction between the analyte and the titrant must occur quickly, without a secondary reaction
- The reaction must go to completion
- The reaction must have well-known stoichiometry (reaction ratio)
- Must have a convenient method of endpoint detection

Titrations are highly precise and can provide many advantages over alternative methods. Titrations are quickly performed and require relatively simple apparatus and instrumentation.

## Automatic Titration

Automatic titration is done with instrumentation that delivers the titrant, stops at the endpoint and calculates the concentration of the analyte automatically. Automatic titrators are best for accurate and repeatable results, as an electrochemical measurement is used to determine the endpoint as opposed to a subjective color indicator.

Analyses that can be performed by potentiometric automatic titrators include:

- Acid-base titrations
- Oxidation reduction titrations
- Complexometric titrations
- Precipitation titrations
- Non-aqueous titrations
- Argentometric titrations
- pH, ORP and Ion selective measurements

Analyses performed by bivoltammetric automatic titrators include:

- Coulometric Karl Fischer titration (trace amounts of water determination)
- Volumetric Karl Fischer titration (greater than 100 ppm water determination)





The required equipment for automatic titration include an automatic titrator equipped with a burette, a standardized titrant, a volumetric pipette (to measure the sample volume) or analytical balance (to measure or weigh a sample), a beaker, a sensor, and a stirring mechanism.

The automatic titrator must have an accurate liquid-dispensing system. In high accuracy systems, this is typically a motor-driven piston burette, a valve system to switch between titrant inlet and outlet, and a titration tip to dispense the titrant into the sample solution. These three main subsystems must be as accurate as possible, with very low gear backlash in the burette drive mechanism, low piston seal flexing, accurate burette glass cylinder diameter, low dead volume in the valve, minimal evaporation/permeation and chemically resistant tubing.

### Standards and Standardization

One of the substances involved in a titration must be used as a standard for which the amount of substance present is accurately known. The standard can be present either in the form of a pure substance or as a solution. The titrant solution can be standardized in two ways; using a primary standard, or more commonly, titrating it against a previously standardized solution.





HI933

## Karl Fischer Volumetric Titrator

*for Moisture Determination*

The HI933 is an automatic volumetric Karl Fischer titrator with high accuracy, great flexibility and repeatability.

The titrator is designed to perform titrations for a variety of sample types/matrices, allowing the user to obtain both good results and high-speed analysis. The HI933 analyzes for water content ranging from 100 ppm to 100%. This powerful titrator automatically dispenses the titrant, detects the endpoint, and performs all necessary calculations and graphing.

[See page 4.22](#)



HI934

## Karl Fischer Coulometric Titrator

The HI934 is an Karl Fischer coulometric titrator with high accuracy, great flexibility and repeatability.

The titrator is designed to perform titrations for a variety of applications, allowing the user to obtain both good results and high-speed analysis. The HI934 analyzes for water content ranging from 1 ppm to 5%. This powerful titrator effectively monitors the KF reaction, detects the endpoint, and performs all necessary calculations and graphing.

[See page 4.26](#)

HI84530 • HI84531

## Total Titratable Acidity and Titratable Alkalinity



	Low Range Acidity	High Range Acidity	Low Range Alkalinity	High Range Alkalinity	pH Range	Temperature Range (°C)	Three-point pH Calibration	Automatic Temperature Compensation	GLP Features	Backlit Display	Data Logging	PC Connectivity	Page
HI84534	•	•			•	•	•	•	•	•	•	•	4.40
HI84530	•	•			•	•	•	•	•	•	•	•	4.42
HI84531			•	•	•	•	•	•	•	•	•	•	4.44

HI84529

## Dairy Products



	Low Range Acidity	High Range Acidity	pH Range	Temperature Range	Automatic Temperature Compensation	Three-point pH Calibration	GLP Features	Backlit Display	Data Logging	PC Connectivity	Page
HI84529	•	•	•	•	•	•	•	•	•	•	4.46

HI84532

## Acidity in Fruit Juice



	pH Range	Temperature Range (°C)	Citric Acid Range	Malic Acid Range	Tartaric Acid Range	Three-point pH Calibration	Automatic Temperature Compensation	GLP Features	Data Logging	Backlit Display	PC Connectivity	Page
HI84532	•	•	•	•	•	•	•	•	•	•	•	4.48

HI84500 • HI84502 • HI84533

## Wine Products



	Formol Number	Tartaric Acid Range	ORP Range	Sulfur Dioxide Range	pH Range	Temperature Range	Three-point pH Calibration	Automatic Temperature Compensation	GLP Features	Data Logging	Backlit Display	PC Connectivity	Page
HI84533	•				•	•	•	•	•	•	•	•	4.50
HI84500		•	•		•	•	•	•	•	•	•	•	4.52
HI84502		•		•	•	•	•	•	•	•	•	•	4.54



HI932

## Automatic Potentiometric Titration System (pH/mV/ISE)

The HI932 Advanced Automatic Titrator is the answer to your advanced titration needs. Fully customizable to meet your testing needs, the HI932 delivers accurate results and intuitive user experience, all in a compact package. Titrate for a variety of published methods at the push of a button, as well as perform direct measurements and back titrations for complex samples. For those that require greater automation, pair your HI932 with the HI922 Autosampler for the most accurate results with the least amount of effort.

- Small footprint so you can fully optimize your benchtop and increase productivity.
- Reduce downtime and increase efficiency when you perform multiple analyses linked in sequence.
- Works seamlessly with the HI922 Autosampler for automation of up to 18 samples.

### Superior design for superior results.

The Cylcoloy® body is durable, heat-resistant, and resists staining. Menu buttons are part of the display making it fully sealed and easy to clean. A high contrast LCD display makes every character on the display stand out and the wide viewing angle allows measurements to be seen from any angle. The backlight is adjustable for perfect viewing and a backlight saver option protects the display during periods of inactivity.

### Maximize your workspace.

This new generation of titrator features a 50% smaller footprint than the HI902 Automatic Titrator for maximum use of your lab space. Use it in any sized space while providing accurate and consistent results.

### Simple user experience

Virtual keys present on the display allow for simple and quick navigation between screens and menus without getting lost in a nest of information. If you need additional information about a screen, simply press the dedicated button for help.

## Titrator Capabilities

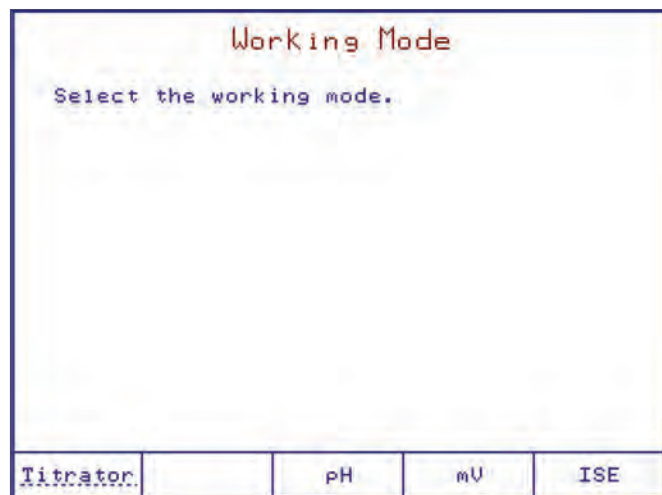

### Multiple Titration Types

Paired with the right electrode from our sensor line, this potentiometric titrator can perform any number of standard titrations, back titrations, as well as perform direct pH, ORP, and ion selective readings.

### Dynamic titrant dosing

The dynamic dosing feature allows for timely and accurate titration results by relating the titrant volume dosed to the mV response from the titration reaction. This provides for larger doses near the beginning of a titration and smaller, more precise doses near the titration endpoint.

### Equivalence endpoint detection

Equivalence endpoint detection is critical in applications where fixed endpoints are not specified in standard methods. This endpoint indicates where the mV response from the titration is greatest with respect to the volume of titrant dosed.

### Multiple equivalence point detection

HI932 can detect multiple equivalence points during one titration as specified and required in certain standard methods and applications.

### Signal stability timing

The signal stability feature monitors when the mV response of the titration reaction stabilizes before providing the next titrant dose. This ensures reliable measurement values throughout the length of a titration.

### Streamline your testing with method sequencing

Reduce downtime and increase efficiency when you perform multiple analyses linked in sequence. A linked method function allows for two analyses to be run on the same sample including direct measurements, fixed endpoint titrations, multiple (up to 5) equivalence point titrations, and back titrations. Track your progress in real-time with onscreen titration curves.

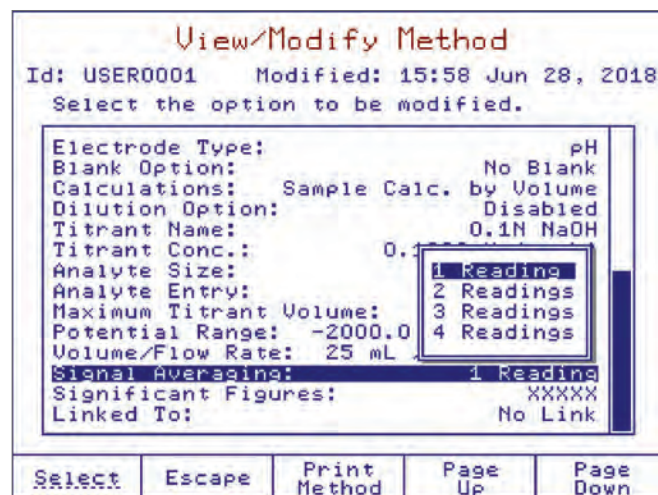

### Customizable methods

These titrators can store up to 100 user-defined or standard titration and direct measurement methods. Each method may be modified and optimized for performance based on application and user requirements.

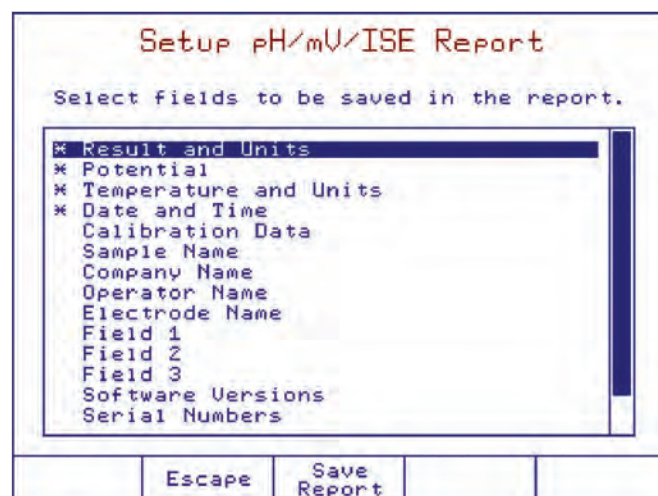

### Customizable Analysis Reports

Each analysis report is fully customizable to ensure the best data required for an application is stored and filed. The Multiselect feature makes batch processing simple.

## Burettes and Dosing System



### Clip Lock™ exchangeable burette system

With Hanna's Clip-Lock™ burette feature, it only takes a few seconds to exchange titrants and reagents preventing cross-contamination and saving time.

### Multiple burette sizes

HI932 is supplied with a 25 mL burette but may be equipped with a 5 mL, 10 mL, or 50 mL burette. Each burette is constructed with a ground glass syringe and chemically resistant PTFE plunger.



### Automatic Reagent Addition

A peristaltic pump or a second burette may be programmed to volumetrically dispense reagent prior to titration or direct measurement or aspirate post-analysis. This helps achieve consistent and accurate results and prevents operator errors such as incorrect volumes or forgetting reagent addition.

### Precision dosing pump

Our unmatched 40,000-step piston driven pump is capable of dosing extremely small and highly accurate volumes of titrant or reagent.

### Chemically resistant tubing

Aspiration and dispensing tubes are constructed of durable, chemically resistant PTFE and feature a light-blocking polyurethane outer sleeve to protect light sensitive reagents.

## Interface and Display

### Interactive color display

A large, color LCD screen clearly shows the chosen titration method along with results, units, titration volume, temperature, and mV or pH values.

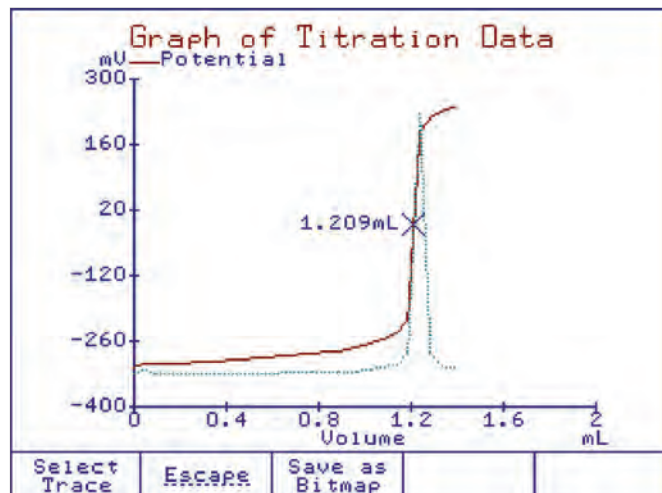

### Detailed titration graphs

A real-time titration curve can be displayed during each titration; this feature is useful when new methods are tested or when a procedure requires optimization.

## Connectivity and Functionality

### Stay connected.

Connect devices such as an analytical balance for automatic weight sample entry or a printer to print reports directly from the titrator.

### Multifunctional

These titrators also function as a titrator, pH meter, mV/ORP meter, and ISE meter. Valuable laboratory bench space is saved, and multiple analyses can be performed on one sample.



### Rear connections

HI932 offers support for two analog boards, allowing up to two electrodes, two burettes, and two stirrers to be connected to one unit.

## Data

### Data storage

up to 100 titration and pH/mV/ISE reports. Transfer data via USB.

### Effortless data transfer

A conveniently located USB port or direct connection to a PC allows for the transfer of titration methods, titration reports, and software upgrades. Easily convert titration methods from our software to an LIMS friendly format.

### Flexible GLP Management

All necessary GLP (Good Laboratory Practice) information is recorded with each sample including sample identification, company and operator name, date, time, electrode ID codes, and calibration information.

### Enhanced security options

Administrative users can set a PIN code on the device protecting against unauthorized access. Titration method options and results are tamper-proof while a non-administrator operates the titrator, ensuring records remain safe, secure, and traceable.



### Designed for dynamic environments.

Don't worry about small spills in the laboratory with built-in spill handling. An external gutter system protects important connections and interior trays safeguard internal electronics

### Take advantage of the versatility.

HI932 functions as a titrator, pH meter, mV/ORP meter, and ISE meter. Valuable laboratory bench space is saved, and multiple tests can be performed on one sample.

## Electrode holder

This electrode holder can hold up to 3 electrodes, 4 tubes, and 1 temperature probe at any given time. The holder is angled and the stirrer is removable for access to smaller volume titrations without hassle.

Use electrodes with different diameters when needed by simply changing the electrode guide. No need to move electrodes around, get the best tube alignment for your titration with a rotating holder.

For a more compact design, the electrode holder is mounted directly onto the titrator body. The press-to-release button makes for simple height control. Need to save more space? Just reverse the holder to accommodate larger beakers.

The electrode holder is easy to flip to gain added height.



## Smarter stirring

The removable overhead stirrer has built-in speed control for more consistent stirring.



## Autosampler connectivity

The HI932 works seamlessly with our HI922 Autosampler featuring 16 or 18 sample tray options, automatic tray identification, and automatic beaker detection. Up to three peristaltic pumps for reagent addition and removal can be connected and real-time analysis and sequencing progress is visible on the HI932 display as well as indicated by the LED lights of the Autosampler.

## Specifications

### HI932C1 / HI932C2

Analysis Type	standard titration (standardization, fixed pH/ mV, equivalence point pH/ mV back Titration direct Reading	
End Point Mode	fixed mV fixed pH mV Equivalence Point (up to 5 points, 1st or 2nd derivate) pH Equivalence Point (up to 5 points, 1st or 2nd derivate)	
Burette	Size	5 mL / 10 mL / 25 mL / 50 mL
	Resolution	0.001 mL
	Flow Rate	0.3 mL to 2 x Burette volume per minute
	Accuracy	± 0.005 mL (5 mL Burette) ± 0.010 mL (10 mL Burette) ± 0.025 mL (25 mL Burette) ± 0.050 mL (50 mL Burette)
Stirrer	Range	200 to 2500 RPM
	Resolution	100 RPM
pH	Range	-2.0 to 20.0 pH; -2.00 to 20.00 pH; -2.000 to 20.000 pH
	Resolution	0.1; 0.01; 0.001 pH
	Accuracy (@25°C/77°F)	±0.001 pH
	pH Calibration	up to five-point calibration, eight standard buffers and five custom buffers



mV	Range	-2000.0 to 2000.0 mV
	Resolution	0.1 mV
	Accuracy (@25°C/77°F)	±0.1 mV
	mV Calibration	single point offset
ISE	Range	1•10 <sup>-6</sup> to 9.999•10 <sup>10</sup>
	Resolution	1; 0.1; 0.01
	Accuracy (@25°C/77°F)	± 0.001 pH
	ISE Calibration	up to five-point calibration, seven standard solutions and five user-defined standards
Temperature	Range	-5.0 to 105.0°C; 23.0 to 221.0°F; 268.2 to 378.2 K
	Resolution	0.1°C; 0.1°F; 0.1K
	Accuracy (@25°C/77°F)	±0.1°C; ±0.2°F; ±0.1K, excluding probe error
Data Storage	Methods	up to 100 titration methods (standard and user) up to 30 autosampler sequences
	Reports	up to 100 titration and pH/mV/ISE reports up to 40 autosampler tray reports (e.g. 720 reports for 18 beaker tray)
Connections	Measurement (per analog board)	BNC Socket (pH, ORP, ISE half-cell and ISE combination electrodes) 4 mm Banana Socket (reference electrode) RCA Socket (temperature sensor) 6-pin Connector (stirrer)
	Peripheral	6-pin Mini DIN (external PC keyboard) DB-25 Socket (printer) USB Standard B (PC connection) DB-9 Socket (analytical balance) USB Standard A (USB flash drive)
Additional Specifications	Electrode Holder	multi-purpose slots (titrant/reagent tubes) (4) 12-mm electrode slots (3) temperature sensor slot overhead stirrer slot
	Analog Board(s) Capability	2
	Dosing Pump Capability	2
	Burette Included	1 (25 mL)
	Burette Size Capability	5, 10, 25 and 50 mL
	Burette Resolution	1/40000
	Display Resolution	0.001 mL
	Dosing Accuracy	±0.1% of full burette volume
	GLP Conformity	instrumentation data storage and printing capabilities
	Linked Methods	yes
	Back Titrations	yes
	HI922 Compatible	yes
	Display	5.7" graphical color display with backlight
	Languages	English, Portuguese, Spanish
	Power Supply	100-240 Vac, 50/60 Hz "-01" models, US plug (type A) "-02" models, European plug (type C)
	Power Draw	0.5 Amps
	Operating Environment	10 to 40 °C (50 to 104 °F); up to 95 % RH
	Storage Environment	-20 to 70 °C (-4 to 158 °F); up to 95 % RH
	Dimensions	315 x 205 x 375 mm (12.4 x 8.1 x 14.8")
	Weight	approx. 4.3 kg (9.5 lbs.) with 1 pump, stirrer and sensors
Ordering Information	<p><b>HI932C1-01</b> and <b>HI932C1-02</b> includes titrator with one analog board*.  <b>HI932C2-01</b> and <b>HI932C2-02</b> includes titrator with two analog boards*.</p> <p>All models also include: overhead propeller stirrer with stand, 25 mL glass burette, dosing pump, temperature sensor, USB cable, USB flash drive and PC software.</p>	
Accessories	<b>HI930101</b>	dosing pump with peristaltic pump
	<b>HI930100</b>	dosing pump
	<b>HI930150</b>	50 mL burette assembly (includes syringe, aspiration, and dispensing tubes)
	<b>HI930125</b>	25 mL burette assembly (includes syringe, aspiration, and dispensing tubes)
	<b>HI930110</b>	10 mL burette assembly (includes syringe, aspiration, and dispensing tubes)
	<b>HI930105</b>	5 mL burette assembly (includes syringe, aspiration, and dispensing tubes)

\*Each Analog Board Provides: (1) BNC (pH/mV/ISE) Input, (1) Reference Input, (1) Temperature Input, (1) Stirrer Input



control panel

## Automate up to 18 samples

The HI922 Autosampler is an automated titration sample handling system designed for use with the HI932 Automatic Titration System, making multiple sample titrations quick and easy.

With the Autosampler, up to 18 samples can be run consecutively. The HI922 Autosampler interfaces directly with the HI932 to access titration methods. Once a titration method is established, the user can fully customize the automation sequence of their samples for this method. Sample names and size can be customized or auto-filled with preset values. One beaker can be designated for storage

purposes before and after titration sequences; up to three beakers per tray can be designated for an electrode rinse sequence, allowing for sufficient removal of solutions that are hard to clean between each sample titration. During each sample titration, the real-time progress is shown on the HI932 display. Finished sample results and graphs can be accessed during and after the titrations have finished.

Once the Autosampler sequence is complete, two reports are available for review: a sequence report featuring a table outlining each sample name, beaker position, sample size, and result for the tray, and a detailed titration report for each individual sample, including the graph of the titration data.

## 16 or 18 Sample Tray

The HI922 is able to automate samples using a 16 sample tray or an 18 sample tray. The 16 sample tray holds 150 mL beakers; the 18 sample tray holds 100 mL beakers. The Autosampler trays are composed of chemically resistant materials and are removable to allow for easy handling. The dishwasher safe trays provide a quick and simple way for users to clean regularly.

## Built-in Magnetic Stirrer

A magnetic stirrer comes built-in with each Autosampler tray. Users simply need to add a small magnetic stir bar to each beaker to ensure homogeneity during titrations. An optional overhead propeller stirrer can also be installed for use instead of the built-in stirrer. The HI922 allows users to easily adjust the stirring speed of both the built-in and overhead stirrers for optimal use.

## Built-in RFID

The HI922 sample trays feature a built-in RFID reader that is able to communicate the tray size and serial number of each tray. Users can have multiple trays, each designated to a specific set of samples. The RFID reader can ensure that the appropriate tray is used each time.

### Absolute Encoder

The Autosampler consistently tracks the tray position without the need to “home” or calibrate.

### Barcode Reader

A USB-compatible barcode reader can be used to associate names with each sample for improved organization of data.

### Optical IR Beaker Detection

An optical IR beam is able to detect the presence or absence of beakers within the sample tray. Users can dictate the Autosampler action if a beaker is missing from the tray during a titration sequence. If a beaker is detected as missing, the HI921 can skip over the sample or stop the titration sequence.

### Versatile Electrode Holder

The durable electrode holder is able to accommodate three 12 mm electrodes, a temperature sensor, one aspiration tube, and five multipurpose tubes. The multipurpose tubes can be utilized for actions such as reagent addition or burette dosing.

### Electrode Rinse Feature

Up to 3 beakers per tray can be designated for electrode dip/spray rinses.

### Sample Leveling Feature

Automatic leveling for fast preparation of volumetric samples.

### Waste Removal Feature

Aspirate completed samples into a waste container.

### Use with the HI932 Automatic Titration System

Flexible, accurate detection of the titration endpoint with HI932 potentiometric titrator.

Real-time progress of the sequence and results shown on the HI932 titrator screen.

### Control Panel

The included control panel features multiple buttons to allow for manual operation of the Autosampler tray, electrode holder, and any auxiliary pumps. A two-line backlit display on the handheld panel clearly displays status information. Manual control with the control panel is desirable for calibration, sample preparation, and method optimization.





## Peristaltic and Membrane Pumps

- Up to three peristaltic pumps can be added at anytime
- User replaceable pump systems
- Peristaltic pumps
  - Uses high performance plastic that is engineered to be chemically resistant and have long service life.
  - Reagent addition, sample leveling, waste removal
  - Greater than 200 mL/min flow
- Membrane pumps
  - Simple plug connection for tubing
  - Greater than 400 mL/min flow

Users can add up to three peristaltic pumps or one membrane pump at any time with the user-replaceable pump systems on the HI922. The peristaltic pumps use high performance plastic that is engineered to be chemically resistant with a long service life. These pumps have a flow greater than 200 mL/min and can be utilized for reagent addition, sample leveling, and waste removal. The membrane pump is a simple plug connection for tubing that has a flow greater than 400 mL/min.

## Status indicator lights

Highly visible status lights are located on both sides of the Autosampler. These lights correspond to the status indicator on the HI932 display and can easily be seen from far away. The lights double as a safety feature, as pressing them at any time will automatically stop the current titration sequence.



- **Steady green**
  - Idle, ready to start
- **Flashing green**
  - Titration sequence running

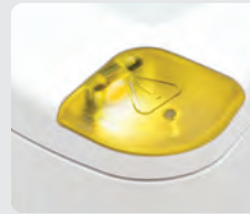

- **Flashing yellow**
  - Titration sequence paused



- **Steady Red**
  - Error or emergency stopped, or initializing during power on
- **Flashing Red**
  - Error during sequence running or manual operation

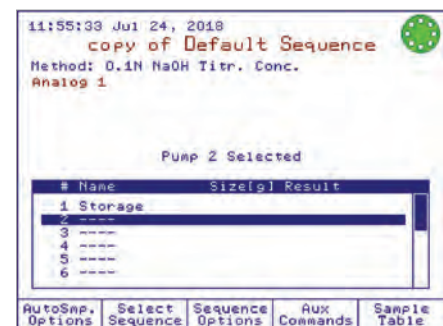
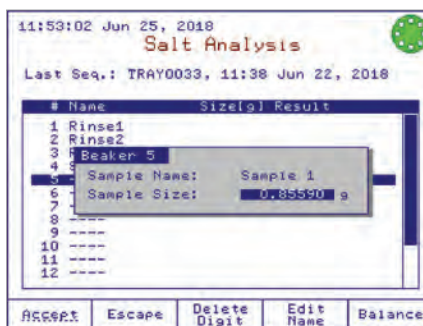
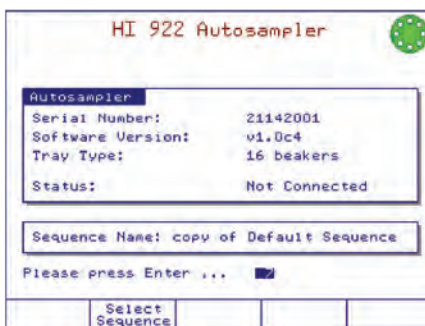

## RFID recognition

Sample trays are automatically detected and identified when placed on the Autosampler.

## Digital balance compatibility

Sample weights are communicated when connected to a digital balance.

## Speedy sample entry

Sample names can be automatically incremented for speedy sample identification.



## Specifications

## HI922

Electrode Holder Slots	3 x 12-mm electrodes	Trays	16 beakers x 150 mL (HI920-11660)
	1 temperature sensor		18 beakers x 100 mL (HI920-11853)
	1 aspiration tube		built-in RFID, transmits the tray type and serial number to Autosampler
	5 multi - purpose slots (titrant/reagent tubes)		ASTM short-form glass beakers
	1 overhead stirrer		HI920-060 (120 mL), fits HI920-11660 tray - 20 plastic beakers
Temperature Sensor	HI7662-A (included)	Beakers	HI920-053 (100 mL), fits HI920-11853 tray - 20 plastic beakers
Stirrers	built-in magnetic stirrer	Control Panel	buttons for manual operation of tray and titration head
	overhead propeller stirrer (optional)		manual operation of peristaltic or membrane pumps
Peristaltic Pumps	up to 3 can be installed	Barcode Reader	2-line backlit display with status information
	installs in slots #1, 2, 3		compatible with USB barcode readers, used to add sample names
Membrane Pump (for cleaning)	installs in slot #4	Report Storage	up to 40 trays of samples (e.g.: 720 reports for 18-beaker tray)

## Ordering Information

Choose your Autosampler configuration:

x=	1	16 sample tray
	2	18 sample tray
y=	0	no peristaltic pump
	1	one peristaltic pump
	2	two peristaltic pumps
	3	three peristaltic pumps
z=	0	no membrane pump

**HI922 – x y z**



HI931

## Automatic Potentiometric Titration System (pH/mV/ISE)

The HI931 Automatic Titrator is the answer to your dedicated titration needs. Fully customizable, the HI931 delivers accurate results and intuitive user experience, all in a compact package. Titrate for a variety of measurements at the push of a button including acids, bases, redox, and selective ions. With no additional programming upgrades to purchase, you can start measuring right away.

- Small footprint so you can fully optimize your benchtop and increase productivity.
- Unmatched 40,000-step dosing pump for small volumes of titrant to help you achieve a very precise endpoint for greater consistency.
- Perfect for dedicated titration needs.

### Superior design for superior results.

The Cyclocoly® body is durable, heat-resistant, and resists staining. Menu buttons are part of the display making it fully sealed and easy to clean. A high contrast LCD display makes every character on the display stand out and the wide viewing angle allows measurements to be seen from any angle. The backlight is adjustable for perfect viewing and a backlight saver option protects the display during periods of inactivity.

### Maximize your workspace.

This new generation of titrator features a 50% smaller footprint than the HI901 Automatic Titrator for maximum use of your lab space. Use it in any sized space while providing accurate and consistent results.

### Simple user experience

Virtual keys present on the display allow for simple and quick navigation between screens and menus without getting lost in a nest of information. If you need additional information about a screen, simply press the dedicated button for help.

## Titration Capabilities

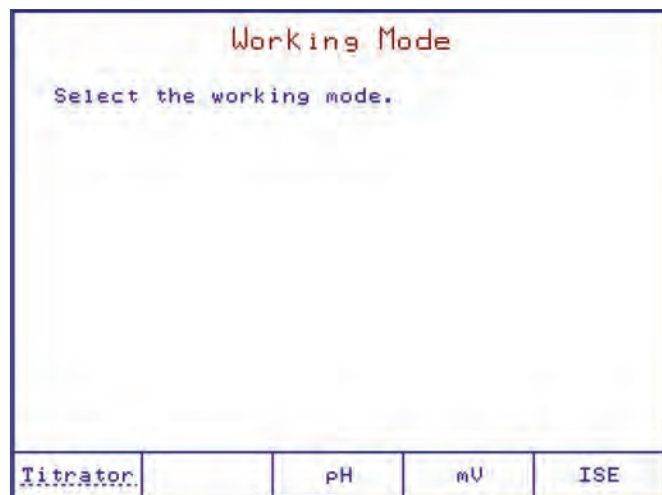

### Multiple Titration Types

Paired with the right electrode, this potentiometric titrator can perform any number of standard titrations including pH and mV tests with fixed endpoints or single equivalence points.

### Dynamic titrant dosing

The dynamic dosing feature allows for timely and accurate titration results by relating the titrant volume dosed to the mV response from the titration reaction. This provides for larger doses near the beginning of a titration and smaller, more precise doses near the titration endpoint.

### Equivalence endpoint detection

Equivalence endpoint detection is critical in applications where fixed endpoints are not specified in standard methods. This endpoint indicates where the mV response from the titration is greatest with respect to the volume of titrant dosed.

### Signal stability timing

The signal stability feature monitors when the mV response of the titration reaction stabilizes before providing the next titrant dose. This ensures reliable measurement values throughout the length of a titration.

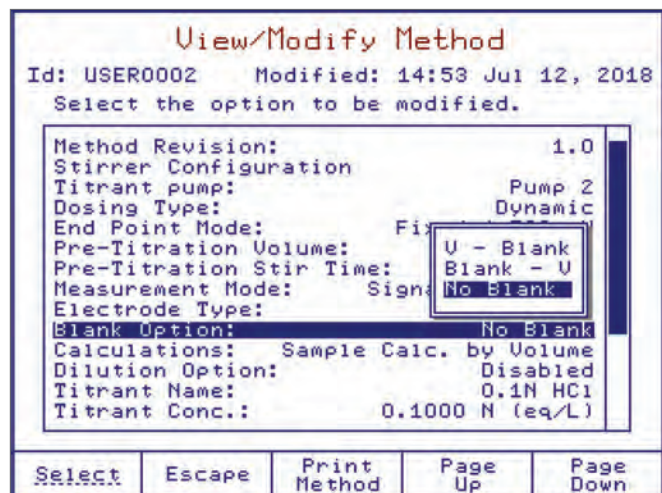

## Customizable methods

These titrators can store up to 100 user-defined or standard titration and direct measurement methods. Each method may be modified and optimized for performance based on application and user requirements.

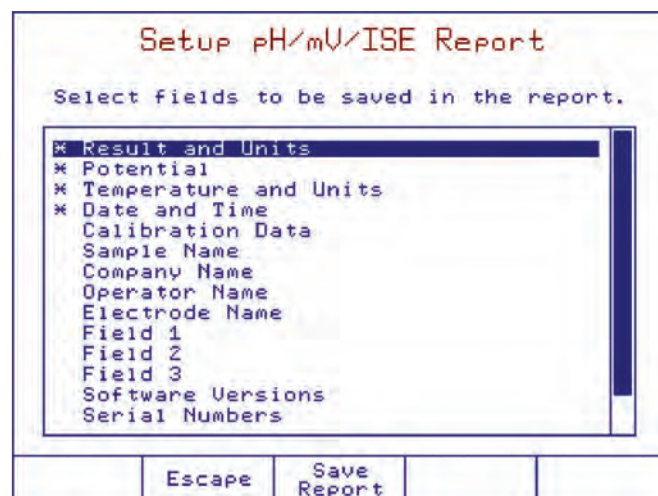

### Customizable Analysis Reports

Each analysis report is fully customizable to ensure the best data required for an application is stored and filed. The Multiselect feature makes batch processing simple.

## Burettes and Dosing System



### Clip Lock™ exchangeable burette system

With Hanna's Clip-Lock™ burette feature, it only takes a few seconds to exchange titrants and reagents preventing cross-contamination and saving time.

### Multiple burette sizes

HI931 is supplied with a 25 mL burette but may be equipped with a 5 mL, 10 mL, or 50 mL burette. Each burette is constructed with a ground glass syringe and chemically resistant PTFE plunger.



### Precision dosing pump

Our unmatched 40,000-step piston driven pump is capable of dosing extremely small and highly accurate volumes of titrant or reagent.

### Chemically resistant tubing

Aspiration and dispensing tubes are constructed of durable, chemically resistant PTFE and feature a light-blocking polyurethane outer sleeve to protect light sensitive reagents.

## Interface and Display

### Interactive color display

A large, color LCD screen clearly shows the chosen titration method along with results, units, titration volume, temperature, and mV or pH values.

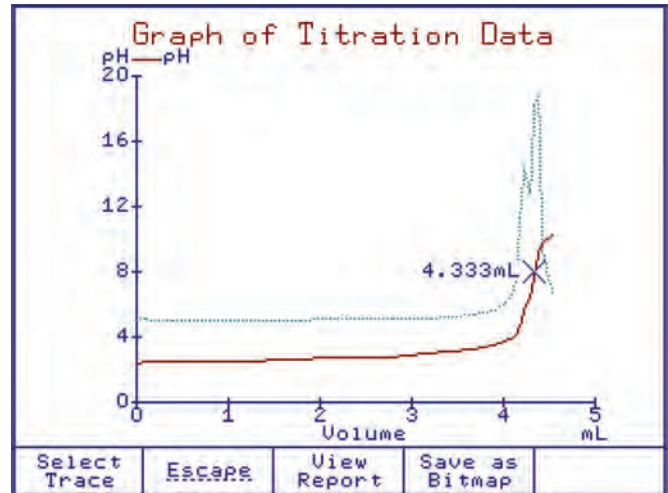

### Detailed titration graphs

A real-time titration curve can be displayed during each titration; this feature is useful when new methods are tested or when a procedure requires optimization.

## Connectivity and Functionality

### Stay connected.

Connect devices such as an analytical balance for automatic weight sample entry or a printer to print reports directly from the titrator.

### Multifunctional

These titrators also function as a titrator, pH meter, mV/ORP meter, and ISE meter. Valuable laboratory bench space is saved, and multiple analyses can be performed on one sample.



### Rear connections

HI931 offers support for one analog board to allow an electrode, a stirrer, and up to two burettes to be connected to one unit.



## Data

### Data storage

up to 100 titration and pH/mV/ISE reports. Transfer data via USB.

### Effortless data transfer

A conveniently located USB port or direct connection to a PC allows for the transfer of titration methods, titration reports, and software upgrades. Easily convert titration methods from our software to an LIMS friendly format.

### Flexible GLP Management

All necessary GLP (Good Laboratory Practice) information is recorded with each sample including sample identification, company and operator name, date, time, electrode ID codes, and calibration information.

### Enhanced security options

Administrative users can set a PIN code on the device protecting against unauthorized access. Titration method options and results are tamper-proof while a non-administrator operates the titrator, ensuring records remain safe, secure, and traceable.



### Designed for dynamic environments.

Don't worry about small spills in the laboratory with built-in spill handling. An external gutter system protects important connections and interior trays safeguard internal electronics

### Take advantage of the versatility.

HI931 functions as a titrator, pH meter, mV/ORP meter, and ISE meter. Valuable laboratory bench space is saved, and multiple tests can be performed on one sample.

## Electrode holder

This electrode holder can hold up to 3 electrodes, 4 tubes, and 1 temperature probe at any given time. The holder is angled and the stirrer is removable for access to smaller volume titrations without hassle.

Use electrodes with different diameters when needed by simply changing the electrode guide. No need to move electrodes around, get the best tube alignment for your titration with a rotating holder.

For a more compact design, the electrode holder is mounted directly onto the titrator body. The press-to-release button makes for simple height control. Need to save more space? Just reverse the holder to accommodate larger beakers.



The electrode holder is easy to flip to gain added height.



## Smarter stirring

The removable overhead stirrer has built-in speed control for more consistent stirring.

### Specifications

Specifications		HI931
Analysis Type		standard titration (standardization, fixed pH/ mV, equivalence point pH/ mV)
End Point Mode		Fixed mV Fixed pH mV Equivalence Point (1st or 2nd derivate) pH Equivalence Point (1st or 2nd derivate)
Burette	Size	5 mL / 10 mL / 25 mL / 50 mL
	Resolution	0.001 mL
	Flow Rate	0.3 mL to 2 x Burette volume per minute
	Accuracy	± 0.005 mL (5 mL Burette) ± 0.010 mL (10 mL Burette) ± 0.025 mL (25 mL Burette) ± 0.050 mL (50 mL Burette)

Stirrer	Range	200 to 2500 RPM
	Resolution	100 RPM
pH	Range	-2.0 to 20.0 pH; -2.00 to 20.00 pH; -2.000 to 20.000 pH
	Resolution	0.1; 0.01; 0.001 pH
	Accuracy (@25°C/77°F)	±0.001 pH
	pH Calibration	up to five-point calibration, eight standard buffers and five custom buffers
mV	Range	-2000.0 to 2000.0 mV
	Resolution	0.1 mV
	Accuracy (@25°C/77°F)	±0.1 mV
	mV Calibration	single point offset
ISE	Range	1•10 <sup>-6</sup> to 9.999•10 <sup>10</sup>
	Resolution	1; 0.1; 0.01
	Accuracy (@25°C/77°F)	± 0.001 pH
	ISE Calibration	up to five-point calibration, seven standard solutions and five user-defined standards
Temperature	Range	-5.0 to 105.0°C; 23.0 to 221.0°F; 268.2 to 378.2 K
	Resolution	0.1°C; 0.1°F; 0.1K
	Accuracy (@25°C/77°F)	±0.1°C; ±0.2°F; ±0.1K, excluding probe error
Data Storage	Methods	up to 100 titration methods (standard and user)
	Reports	up to 100 titration and pH/mV/ISE reports
Connections	Measurement	BNC Socket (pH, ORP, ISE half-cell and ISE combination electrodes) 4 mm Banana Socket (reference electrode) RCA Socket (temperature sensor) 6-pin Connector (stirrer)
	Peripheral	6-pin Mini DIN (external PC keyboard) DB-25 Socket (printer) USB Standard B (PC connection) DB-9 Socket (analytical balance) USB Standard A (USB flash drive)
Additional Specifications	Electrode Holder	multi-purpose slots (titrant/reagent tubes) (4) 3 x 12-mm electrode slots (3) temperature sensor slot overhead stirrer slot
	Analog Board(s) Capability	1
	Dosing Pump Capability	2
	Burette Included	1 (25 mL)
	Burette Size Capability	5, 10, 25 and 50 mL
	Burette Resolution	1/40000
	Display Resolution	0.001 mL
	Dosing Accuracy	±0.1% of full burette volume
	GLP Conformity	instrumentation data storage and printing capabilities
	Display	5.7" graphical color display with backlight
	Languages	English, Portuguese, Spanish
	Power Supply	100-240 Vac, 50/60 Hz "-01" models, US plug (type A) "-02" models, European plug (type C)
	Power Draw	0.5 Amps
	Operating Environment	10 to 40 °C (50 to 104 °F); up to 95 % RH
	Storage Environment	-20 to 70 °C (-4 to 158 °F); up to 95 % RH
	Dimensions	315 x 205 x 375 mm (12.4 x 8.1 x 14.8")
	Weight	approx. 4.3 kg (9.5 lbs.) with 1 pump, stirrer and sensors
Ordering Information	<b>HI931-01</b> and <b>HI931-02</b> includes titrator with one analog board*. All models also include: overhead propeller stirrer with stand, 25 mL glass burette, dosing pump, temperature sensor, USB cable, USB flash drive and PC software.	
Accessories	<b>HI930100</b>	dosing pump
	<b>HI930150</b>	50 mL burette assembly (includes syringe, aspiration, and dispensing tubes)
	<b>HI930125</b>	25 mL burette assembly (includes syringe, aspiration, and dispensing tubes)
	<b>HI930110</b>	10 mL burette assembly (includes syringe, aspiration, and dispensing tubes)
	<b>HI930105</b>	5 mL burette assembly (includes syringe, aspiration, and dispensing tubes)

\*Each Analog Board Provides: (1) BNC (pH/mV/ISE) Input, (1) Reference Input,  
(1) Temperature Input, (1) Stirrer Input



HI933

## Karl Fischer Volumetric Titrator

*for Moisture Determination*

The HI933 is an automatic volumetric Karl Fischer titrator with high accuracy, great flexibility and repeatability.

The titrator is designed to perform titrations for a variety of sample types/matrices, allowing the user to obtain both good results and high-speed analysis. The HI933 analyzes for water content ranging from 100 ppm to 100%. This powerful titrator automatically dispenses the titrant, detects the endpoint, and performs all necessary calculations and graphing.

- Small footprint, requires minimal bench space
- Casing made with strong, chemically resistant plastic
- Powerful built-in algorithms for termination criteria based on fixed mV endpoint or absolute/relative drift
- Titrant standardization and sample analysis averaging
- Minimized water vapor entry with the Sealed Solvent System
- Balance interface for automatic weighing
- Support for 100 titration methods
- User-customizable reports
- Clearly displayed warning and error messages

## Burette and Dosing System

### Precision Dosing Pump

Our unmatched 40,000 step piston driven pump is capable of delivering as little as 0.125  $\mu\text{L}$  of titrant accurately and precisely.



### Anti-Diffusion Dispensing Tip

A specially designed glass dispensing tip delivers titrant precisely into high turbulence mixing zones, ensuring a rapid reaction. Its angular construction helps prevent titrant from diffusing into the sample solvent.

### Chemically Resistant Tubing and Syringe

Aspiration and dispensing tubes are constructed of durable, chemically resistant PTFE and feature a light-blocking polyurethane outer sleeve to protect light sensitive reagents.

## Titration and Solvent System

### Efficient Sample Handling

The HI933 features a quick-remove sample port with a replaceable rubber septum allowing for fast and easy sample introduction to the titration vessel. An integrated magnetic stirrer ensures homogeneity for an accurate and speedy reaction.

### Chemically Resistant Titration Vessel

The glass and PTFE titration cell and fittings are designed to withstand the harsh solvents and reagents involved in Karl Fischer reactions.

### Sealed Solvent System

The titration vessel is completely sealed to minimize exposure to ambient humidity, keep the system dry, and reduce titrant consumption while saving time between titrations. Solvent may be exchanged in a matter of seconds without opening the titration vessel.

### Visually Recognizable Desiccant

A rechargeable, color-indicating, silica gel desiccant prevents the ingress of ambient humidity into the sealed system while maintaining full titrator functionality. The desiccant color change allows a user to recognize when its adsorption capacity has depleted and is ready for replacement or recharging.



## Titrator Capabilities

### Dynamic Titrant Dosing

The dynamic dosing feature allows for timely and accurate titration results by relating the titrant volume dosed to the mV response from the titration reaction. This provides for larger doses near the beginning of a titration and smaller, more precise doses near the titration endpoint.

### Drift Rate Compensation

The HI933 automatically adjusts the titration calculation to account for the effects of any ambient humidity entering the titration cell. This provides a more accurate result by correcting for water not present in the actual sample.

### Titration Results Averaging

Successive results from a titration method may be averaged with recording of the standard deviation.

## Titration Recordkeeping

The HI933's titrant database can store information for up to 20 titrants. The database may be programmed to remind a user when to standardize their titrant, reducing error in analysis.

## Selectable Endpoint Criteria

The HI933 employs a dual platinum pin electrode for bivalent endpoint determination. Users may choose termination criteria based on mV stability times or drift rates.

## Multistage Cell Preparation

A pre-titration stage eliminates residual water present in the solvent and the cell, providing a reliable baseline start to analysis. Standby mode then keeps the solvent dry between titrations and when the titrator is not in use.

## Interface and Display

### Detailed Titration Graphs

A real-time titration curve can be displayed during each titration; this feature is useful when new methods are tested or when a procedure requires optimization.

### Interactive Color Display

A large, color LCD screen clearly shows the chosen titration method along with results, units, dosing size, titration volume, drift rate, and mV value.

### Simple & Quick Navigation

Virtual key selections present on the display allow for simple and quick navigation between screens and menus without getting lost in a nest of information.



## Data and Storage

### Customizable Titration Reports

Each titration report is fully customizable so users can ensure they are storing and filing the appropriate data required for their application and procedures.

### Flexible GLP Management

All necessary GLP (Good Laboratory Practice) information can be recorded with each sample including: sample identification, company and operator name, date, time, electrode ID codes, and calibration information.

## Effortless Data Transfer

Data can easily be transferred to a USB flash drive or PC with the Hanna HI900PC application software. The USB port allows for the transfer of titration methods, titration reports, and software upgrades via USB flash drive.

## Methods of Analysis

### Customizable Methods

The HI933 can store up to 100 user-defined or standard titration methods. Each method may be customized and optimized for performance based on application and user requirements.

### Titration Method Support

Onsite installation, training, and customization is available from one of our Applications or Service experts. Hanna offers continued support via phone or webinar for any questions you might have along the way.

## Adaptable Standard Methods

Our technical experts can program and customize standard methods developed by such affiliations as ISO, ASTM, AOAC, AOCS, EPA, and more directly onto your titrator. Ask our Sales Consultants which standard methods are possible with our HI933 Karl Fischer system.

## Connectivity and Functionality

### Configurable Balance Interface

Sample size may be automatically entered from any laboratory analytical balance with a RS232 serial output saving time and labor.

### Multiple Peripherals

Users can print reports directly from the titrator using a standard parallel printer. An external monitor and keyboard may be attached for added versatility, as well as an analytical balance for automatic sample mass entry for titrations.

## Versatile Data Management

Easily incorporate into any existing GLP data management program.

- Easily record all necessary GLP information with every sample, such as sample identification, company and operator name, date, time, electrode ID codes and calibration information
- Data can be transferred to a PC using Hanna HI900PC software
- Transfer of methods, reports and software upgrades via a USB flash drive
- Users can print reports of analyses directly from the titrator using a standard parallel printer
- A keyboard can be attached for added versatility

Specifications	HI933	
Measurement	Range	100 ppm to 100%
	Resolution	1 ppm (0.0001%)
	Result Units	%, ppm, mg/g, µg/g, mg, µg, mg/mL, µg/mL, mg/pc, µg/pc
	Sample Type	liquid or solid
Determination	Pre-Titration Conditioning	automatic
	Background Drift Correction	automatic or user-selectable value
	Endpoint Criteria	fixed mV persistence, relative drift stop or absolute drift stop
	Dosing	dynamic with optional pre-dispensing
	Result Statistic	mean, standard deviation
Titration System	Dosing Pump Resolution	1/40000 of the burette volume (0.125 µL per dose) with 5 mL burette
	Dosing Pump Accuracy	±0.1% of full burette volume
	Syringe	5 mL precision ground glass with PTFE plunger
	Valve	motor-driven 3-way, PTFE liquid contact material
	Tubing	PTFE with light block and thermal jacketing
	Dispensing Tip	glass, fixed position, anti-diffusing
	Titration Vessel	conical with operation volume between 50-150 mL
	Solvent Handling System	sealed system, integrated diaphragm air pump
Electrode	Type	HI76320 dual platinum pin, polarization electrode
	Connection	BNC
	Polarization Current	1, 2, 5, 10, 15, 20, 30 or 40 µA
	Voltage Range	2 mV to 1000 mV
	Voltage Resolution	0.1 mV
	Accuracy (@25°C/77°F)	±0.1%
Stirrer	Type	magnetic, optically regulated, digital stirrer
	Speed	200-2000 rpm
	Resolution	100 rpm
Storage	Methods	Up to 100 (standard and user) methods
	Reports	Up to 100 complete titration reports and drift rate reports
Additional Specifications	Display	5.7" graphical color display with backlight
	Peripheral Devices	PC (USB standard B); flash drive (USB standard A); analytical balance (DB-9 Socket); printer (DB-25 Socket); keyboard (6-pin Mini DIN)
	Languages	English, Portuguese, Spanish, and French
	Power Supply / Power Draw	100-240 Vac, 50/60 Hz / 0.5 Amps
	Enclosure Material	ABS/PC and Steel
	Keypad	polyester
	Operating Environment	10 to 40 °C (50 to 104 °F); up to 80 % RH
	Storage Environment	-20 to 70 °C (-4 to 158 °F); up to 95 % RH
	Dimensions	315 x 205 x 375 mm (12.4 x 8.1 x 14.8")
	Weight	approx. 4.3 kg (9.5 lbs.) with 1 pump, stirrer and sensors
Ordering Information	<b>HI933-01</b> and <b>HI933-02</b> are supplied with HI76320 dual platinum pin electrode, dosing pump, 5 mL burette assembly with tubing, air pump/stirrer assembly with tubing, beaker and bottle top assemblies and all fittings, desiccant cartridges (4) with indicating desiccant, stir bar, waste bottle, calibration key, USB cable, power cable, USB flash drive, quality certificate, ISO 8655 burette compliance report and instruction manual binder.	



#### Specifications HI76320

Sensor Type	dual platinum pin polarization electrode
Voltage Range	2 mV to 1000 mV
Voltage Resolution	0.1 mV
Accuracy (@25°C/77°F)	±0.1%
Polarization Current	1, 2, 5, 10, 15, 20, 30 or 40 µA
Sensor Connection	BNC

\*100-240 VAC  
 \*-01\* models, US plug (type A)  
 \*-02\* models, European plug (type C)



HI934

## Karl Fischer Coulometric Titrator

The HI934 is a Karl Fischer coulometric titrator with high accuracy, great flexibility and repeatability.

The titrator is designed to perform titrations for a variety of applications, allowing the user to obtain both good results and high-speed analysis. The HI934 analyzes for water content ranging from 1 ppm to 5%. This powerful titrator effectively monitors the KF reaction, detects the endpoint, and performs all necessary calculations and graphing.

- Small footprint, requires minimal bench space
- Casing made with strong, chemically resistant plastic
- Powerful built-in algorithms for termination criteria based on fixed mV endpoint or absolute/relative drift
- Sample analysis averaging and statistical data
- Minimized water vapor entry with the sealed solvent system
- Balance interface for automatic weighing
- Support for 100 titration methods
- User-customizable reports
- Clearly displayed warning and error messages



## Coulometric Reagent System

### Precision Iodine Generation

Hanna's dosing algorithm allows for an extremely small amount of iodine necessary for the Karl Fischer reaction to be generated electrolytically using a pulsed current up to 400 mA delivering titrant accurately and precisely.

## Titration and Solvent System

### Chemically Resistant Titration Vessel and Tubing

The glass titration cell and PTFE tubing is designed to withstand the harsh solvents and reagents involved in Karl Fischer reactions.

### Sealed Solvent System

Ground glass joints completely seal the glass titration cell minimizing exposure to ambient humidity, keeping the system dry, and reducing reagent consumption while saving time between titrations. Solvent may be exchanged in a matter of seconds with a quick fitting adjustment.

### Molecular Sieve Desiccant

High efficiency molecular sieve desiccant helps maintain low and stable drift rates within the titration cell while preventing the ingress of ambient humidity into the sealed solvent system.

### Digital built-in stirrer

Automatic, integrated magnetic stirrer adjustable from 200-2000 RPM with optical feedback for automatic speed control.

## Titration Capabilities

### Dynamic Titrant Dosing

The titration speed feature allows for timely and accurate titration results by relating the amount of iodine generated to the mV response from the Karl Fischer reaction.

### Drift Rate Compensation

The HI934 automatically adjusts the titration calculation to account for the effects of any ambient humidity entering the titration cell. This provides a more accurate result by correcting for water not present in the actual sample.

### Titration Results Averaging

Successive results from a titration method may be averaged with recording of the standard deviation.

### Selectable Endpoint Criteria

The HI934 employs a dual platinum pin electrode for bivalent endpoint determination. Users may choose termination criteria based on mV stability times or drift rates.

### Multistage Cell Preparation

A pre-titration stage eliminates residual water present in the solvent and the cell, providing a reliable baseline start to analysis. Standby mode then keeps the solvent dry between titrations and when the titrator is not in use.



## Interface & Display

### Detailed Titration Graphs

A real-time titration curve can be displayed during each titration; this feature is useful when new methods are tested or when a procedure requires optimization.

### Interactive Color Display

A large, color LCD screen clearly shows the chosen titration method along with results, units, drift rate, and mV value.

### Simple and Quick Navigation

Virtual key selections present on the display allow for simple and quick navigation between screens and menus without getting lost in a nest of information.

## Data & Storage

### Customizable Titration Reports

Each titration report is fully customizable so users can ensure they are storing and filing the appropriate data required for their application and procedures.

### Flexible GLP Management

All necessary GLP (Good Laboratory Practice) information can be recorded with each sample including: sample identification, company and operator name, date, time, electrode ID codes, and calibration information.

### Effortless Data Transfer

Data can easily be transferred to a USB flash drive or PC with the Hanna HI900PC application software. The USB port allows for the transfer of titration methods, titration reports, and software upgrades via USB flash drive.



## Methods of Analysis

### Customizable Methods

The HI934 can store up to 100 user-defined or standard titration methods. Each method may be customized and optimized for performance based on application and user requirements.

### Titration Method Support

Onsite installation, training, and customization is available from one of our Applications or Service experts. Hanna offers continued support via phone or webinar for any questions you might have along the way.



- **Fritted (Diaphragm) Generator**
  - Anode/anolyte and cathode/catholyte separated by glass diaphragm
  - Prevents anode-generated iodine from being reduced to iodide at the cathode
  - Ideal for extremely low water content, high accuracy demand, nitrogenous compounds and easily reduced samples

## Adaptable Standard Methods

Our technical experts can program and customize standard methods developed by such affiliations as ISO, ASTM, AOAC, AOCS, EPA, and more directly onto your titrator. Ask our Sales Consultants which standard methods are possible with our HI934 Karl Fischer system.

## Connectivity and Functionality

### Configurable Balance Interface

Sample size may be automatically entered from any laboratory analytical balance with a RS232 serial output saving time and labor.

### Multiple Peripherals

Users can print reports directly from the titrator using a standard parallel printer. An external monitor and keyboard may be attached for added versatility, as well as an analytical balance for automatic sample mass entry for titrations.

### Versatile Data Management

- Easily incorporate into any existing GLP data management program:
  - Easily record all necessary GLP information with every sample, such as sample identification, company and operator name, date, time, electrode ID codes and calibration information
- Data can be transferred to a PC using Hanna HI900PC software
- Easy transfer of methods, reports and software upgrades via a USB flash drive
- Users can print reports of analyses directly from the titrator using a standard parallel printer
- A keyboard can be attached for added versatility



- **Fritless (No Diaphragm) Generator**
  - Uses one easy-to-replace Karl Fischer reagent
  - Lower and more stable drift rates
  - Easier cleaning of generator cell

Specifications	HI934	
Measurement	Range	1 ppm to 5%
	Resolution	0.1ppm
	Result Units	%, ppm, mg/g, µg/g, mg, µg, mg/mL, µg/mL, ppt, mgBr/100g, gBr/100g, mgBr, gBr
	Sample Type	liquid or solid (external dissolution or extraction)
Determination	Pre Titration Conditioning	automatic
	Background Drift Correction	automatic or user-selectable value
	Endpoint Criteria	fixed mV persistence, relative drift stop, or absolute drift stop
	Dosing	dynamic with 3 speed settings
	Result Statistic	mean, standard deviation
Titration Vessel	Type	borosilicate glass with standard taper glass joint connections
	Operating Volume	100 to 200 mL
	Septum	silicone rubber
	Septum Cap Thread	GL-18
	Reagent Port	standard Taper 19
Detector Electrode	Type / Connection	HI76330 dual platinum pin, polarization electrode / BNC connector
	Glass Connection	standard Taper 14/20
	Polarization Current	1, 2, 5, or 10 µA
	Voltage Range	2 to 1100 mV
	Voltage Resolution	0.1 mV
	Accuracy (@25°C/77°F)	±0.1%
Generator Electrode	Type	diaphragm or diaphragm-less
	Electrode Type Detection	automatic
	Electrical Connection	5-pin connector with detachable cable
	Glass Connection	standard Taper 29/12
	Maximum Current	400 mA
	Current Control	automatic or Fixed (400 mA)
Stirrer	Type	magnetic, electronic regulated, digital stirrer
	Speed	200 to 2000 RPM
	Resolution	100 RPM
	External Stirrer	4-pin mini DIN connection allows for the control of an external stirring apparatus
Reagent Handling System	Type	sealed system with integrated diaphragm air pump
	Desiccant Type	molecular sieves
	Bottle Thread Type	GL-45
	Glass Connection	standard taper 19 (using supplied adapter)
	Reagent/Waste Tubing	PTFE
Additional Specifications	Display	5.7" graphical color display with backlight
	Peripheral Devices	PC (USB standard B); flash drive (USB standard A); analytical balance (DB-9 Socket); printer (DB-25 Socket); keyboard (6-pin Mini DIN)
	Languages	English, Portuguese, Spanish, and French
	Power Supply / Power Draw	100-240 Vac, 50/60 Hz / 0.5 Amps
	Enclosure Material	ABS/PC and stainless Steel
	Keypad	polyester
	Operating Environment	10 to 40 °C (50 to 104 °F); up to 80 % RH
	Storage Environment	-20 to 70 °C (-4 to 158 °F); up to 95 % RH
	Dimensions	315 x 205 x 375 mm (12.4 x 8.1 x 14.8 ")
Weight	approx. 4.3 kg (9.5 lbs.) with 1 pump, stirrer and sensors	
Ordering Information	<b>HI934D-01 and HI934D-02 are supplied with diaphragm, HI934-01 and HI934-02 are supplied without diaphragm</b>	
	<b>All Models Include:</b> dual platinum pin electrode, air pump/stirrer assembly, titration vessel assembly (glass vessel, accessory port stopper, sample port cap and septum, stir bar, desiccant, desiccant cartridge, fittings), vessel support with adapter, pump locking screw with plastic head, reagent bottle assembly (bottle cap, desiccant, desiccant cartridge, fittings, tubing (silicone and PTFE)), water bottle assembly (waste bottle, bottle cap, desiccant, desiccant cartridge, fittings, tubing (silicone and PTFE)), calibration key, reagent exchange adapter, accessory holder assembly, joint grease, Karl Fischer generator electrode (removable generator electrode cable), USB cable, USB storage device, HI900 PC application software, power adapter, quality certificate and instruction manual binder.	

\*100-240 VAC  
 \*-01" models, US plug (type A)  
 \*-02" models, European plug (type C)

HI90060X Series

## Photometric Electrodes

These photometric probes are used with a potentiometric titration for equivalence end point detection of colorimetric reactions. These probes are available in 4 different wavelengths from 470 nm to 625 nm and have a universal BNC connector that is used as a potentiometric input on Hanna titrators and autosamplers.

- **Reflective Measurement**
  - Allows for a high color sensitivity in a compact design
- **Temperature Compensation**
  - Drift from variances in temperature are automatically compensated
- **Glass Body**
  - All of the photometric probes have a glass body that offers excellent chemical resistance. The body of the electrode is 12 mm in diameter and fits easily into sampling beakers
- **LED Brightness Trimmer**
  - If needed, a trimmer is provided in the head of the electrode to adjust the led output value.

pH, ORP and ISE electrodes are commonly used in potentiometric titrations. These probes produce a voltage that changes as a titrant is dosed into the sample being analyzed. The HI90060X family of photometric probes use the principle of absorbance at a specific wavelength to identify the equivalence point of a titration with the use of a color indicator. The color change of a solution causes a sharp change in the absorbance which also causes a sharp change in the mV response. It is common for a complexometric titration to end in a flat mV response. Using the Hanna potentiometric titrator it is possible to program the meter to use the first derivative as the end point. This program is ideal since when a color indicator is used the color change occurs very distinctly.

The use of a photometric probe for potentiometric titration can be used for a variety of complexometric titrations including calcium and magnesium water hardness and iron, aluminum and calcium in cement materials testing. The photometric probe is also ideal for non-aqueous titrations such as Total Acid Number (TAN) and Total Base Number (TBN) of petroleum products due to its advantages over a standard pH electrode.

With the photometric probe there is no fill solution to change in order to be compatible with a non-aqueous sample and there is no pH sensor to foul.



Each probe has an LED at a specific wavelength that shines light through the sample and reflected back by a platinum mirror sealed in glass. The reflective measurement has a fixed path length and allows for a high color sensitivity in a compact design.

All of the HI90060X have the same design but vary in the wavelength of light used for the photometric analysis.

The probes' open cell design that allows for the solution to pass through with the use of a stirrer.



### Specifications

mV Range	10 to 1100 mV
Wavelength / LED color	<b>HI900601</b> @ 525 nm / green LED <b>HI900602</b> @ 625 nm / red LED <b>HI900603</b> @ 590 nm / orange LED <b>HI900604</b> @ 470 nm / blue LED
Light Source	LED
Measuring Cycle	LED pulsed at 1 kHz
Light Detector	silicon photocell
Sample Temperature	0 to 75°C (32 to 167°F)
Body Material	glass
Body Length / Overall Length	120 mm / 200mm
Outer Diameter	12 mm
Connection	BNC with 1.5 meter cable for connecting to titrator or autosampler
Power supply	ps/2 connector for connecting to titration system
Environment	0 to 50°C (32 to 122°F)
Ordering Information	<b>HI900601</b> (@ 525 nm) is supplied, instruction manual, and electrode quality testing certificate. <b>HI900602</b> (@ 625 nm) is supplied, instruction manual, and electrode quality testing certificate. <b>HI900603</b> (@ 590 nm) is supplied, instruction manual, and electrode quality testing certificate. <b>HI900604</b> (@ 470 nm) is supplied, instruction manual, and electrode quality testing certificate.

HI921

## Autosampler



control panel

### Automate up to 18 samples

The HI921 Autosampler is an automated titration sample handling system designed for use with the HI902C Automatic Titration System, making multiple sample titrations quick and easy.

With the Autosampler, up to 18 samples can be run consecutively. The HI921 Autosampler interfaces directly with the HI902C to access titration methods. Once a titration method is established, the user can fully customize the automation sequence of their samples for this method. Sample names and size can be customized or auto-filled with preset values. One beaker can be designated for storage purposes

before and after titration sequences; up to three beakers per tray can be designated for an electrode rinse sequence, allowing for sufficient removal of solutions that are hard to clean between each sample titration. During each sample titration, the real-time progress is shown on the HI902C display. Finished sample results and graphs can be accessed during and after the titrations have finished.

Once the Autosampler sequence is complete, two reports are available for review: a sequence report featuring a table outlining each sample name, beaker position, sample size, and result for the tray, and a detailed titration report for each individual sample, including the graph of the titration data.

### 16 or 18 Sample Tray

The HI921 is able to automate samples using a 16 sample tray or an 18 sample tray. The 16 sample tray holds 150 mL beakers; the 18 sample tray holds 100 mL beakers. The Autosampler trays are composed of chemically resistant materials and are removable to allow for easy handling. The dishwasher safe trays provide a quick and simple way for users to clean regularly.

### Built-in Magnetic Stirrer

A magnetic stirrer comes built-in with each Autosampler tray. Users simply need to add a small magnetic stir bar to each beaker to ensure homogeneity during titrations. An optional overhead propeller stirrer can also be installed for use instead of the built-in stirrer. The HI921 allows users to easily adjust the stirring speed of both the built-in and overhead stirrers for optimal use.

### Built-in RFID

The HI921 sample trays feature a built-in RFID reader that is able to communicate the tray size and serial number of each tray. Users can have multiple trays, each designated to a specific set of samples. The RFID reader can ensure that the appropriate tray is used each time.

### Absolute Encoder

The Autosampler consistently tracks the tray position without the need to “home” or calibrate.

### Barcode Reader

A USB-compatible barcode reader can be used to associate names with each sample for improved organization of data.

### Optical IR Beaker Detection

An optical IR beam is able to detect the presence or absence of beakers within the sample tray. Users can dictate the Autosampler action if a beaker is missing from the tray during a titration sequence. If a beaker is detected as missing, the HI921 can skip over the sample or stop the titration sequence.

### Versatile Electrode Holder

The durable electrode holder is able to accommodate three 12 mm electrodes, a temperature sensor, one aspiration tube, and five multipurpose tubes. The multipurpose tubes can be utilized for actions such as reagent addition or burette dosing.

### Electrode Rinse Feature

Up to 3 beakers per tray can be designated for electrode dip/spray rinses.

### Sample Leveling Feature

Automatic leveling for fast preparation of volumetric samples.

### Waste Removal Feature

Aspirate completed samples into a waste container.

### Use with the HI902 Automatic Titration System

Flexible, accurate detection of the titration endpoint with HI902C potentiometric titrator.

Real-time progress of the sequence and results shown on the HI902 titrator screen.



### Control Panel

The included control panel features multiple buttons to allow for manual operation of the Autosampler tray, electrode holder, and any auxiliary pumps. A two-line backlit display on the handheld panel clearly displays status information. Manual control with the control panel is desirable for calibration, sample preparation, and method optimization.



## Peristaltic and Membrane Pumps

- Up to three peristaltic pumps can be added at anytime
- User replaceable pump systems
- Peristaltic pumps
  - Uses high performance plastic that is engineered to be chemically resistant and have long service life.
  - Reagent addition, sample leveling, waste removal
  - Greater than 200 mL/min flow
- Membrane pumps
  - Simple plug connection for tubing
  - Greater than 400 mL/min flow

Users can add up to three peristaltic pumps or one membrane pump at any time with the user-replaceable pump systems on the HI921. The peristaltic pumps use high performance plastic that is engineered to be chemically resistant with a long service life. These pumps have a flow greater than 200 mL/min and can be utilized for reagent addition, sample leveling, and waste removal. The membrane pump is a simple plug connection for tubing that has a flow greater than 400 mL/min.

## Status indicator lights

Highly visible status lights are located on both sides of the Autosampler. These lights correspond to the status indicator on the HI902C display and can easily be seen from far away. The lights double as a safety feature, as pressing them at any time will automatically stop the current titration sequence.



- Steady green
  - Idle, ready to start
- Flashing green
  - Titration sequence running



- Flashing yellow
  - Titration sequence paused



- Steady Red
  - Error or emergency stopped, or initializing during power on
- Flashing Red
  - Error during sequence running or manual operation

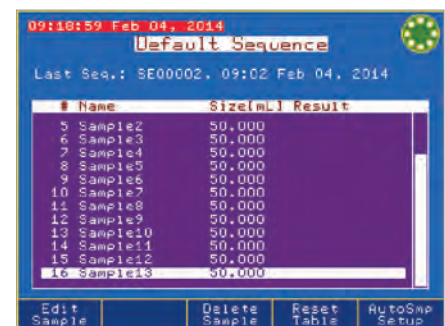
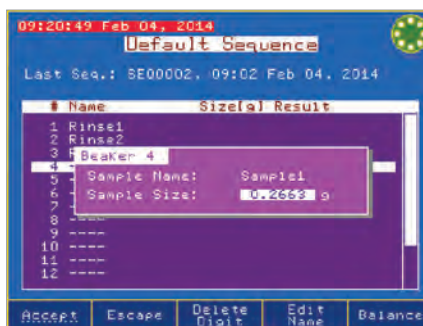
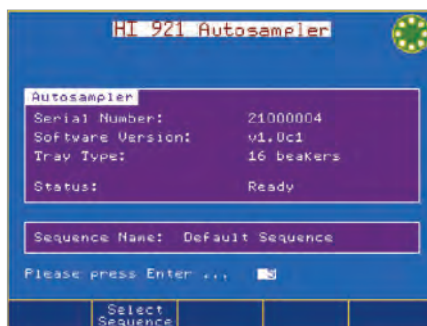

### RFID recognition

Sample trays are automatically detected and identified when placed on the Autosampler.

### Digital balance compatibility

Sample weights are communicated when connected to a digital balance.

### Speedy sample entry

Sample names can be automatically incremented for speedy sample identification.





## Specifications

### HI921

Electrode Holder Slots	3 x 12-mm electrodes	Trays	16 beakers x 150 mL (HI920-11660)
	1 temperature sensor		18 beakers x 100 mL (HI920-11853)
	1 aspiration tube		built-in RFID, transmits the tray type and serial number to Autosampler
	5 multi - purpose slots (titrant/reagent tubes)		ASTM short-form glass beakers
	1 overhead stirrer		HI920-060 (120 mL), fits HI920-11660 tray - 20 plastic beakers
Temperature Sensor	HI7662-A (included)	Beakers	HI920-053 (100 mL), fits HI920-11853 tray - 20 plastic beakers
Stirrers	built-in magnetic stirrer	Control Panel	buttons for manual operation of tray and titration head
	overhead propeller stirrer (optional)		manual operation of peristaltic or membrane pumps
Peristaltic Pumps	up to 3 can be installed	Barcode Reader	2-line backlit display with status information
	installs in slots #1, 2, 3		compatible with USB barcode readers, used to add sample names
Membrane Pump (for cleaning)	installs in slot #4	Report Storage	up to 40 trays of samples (e.g.: 720 reports for 18-beaker tray)

## Ordering Information

Choose your Autosampler configuration:

x=	1	16 sample tray
	2	18 sample tray
y=	0	no peristaltic pump
	1	one peristaltic pump
	2	two peristaltic pumps
z=	3	three peristaltic pumps
	0	no membrane pump

**HI921 – x y z**



HI901W

## Automatic Titration System for Wine

### All-in-one titration solution made for wine.

The HI901W Wine Titrator is perfect for winemakers who need accurate results, ease-of-use, and the ability to expand the system as their analytical needs grow. It comes preloaded with methods for wine analysis, and with Hanna, you get the support you need to run them perfectly in your lab.

The Wine Titrator complements our wide range of products dedicated to efficient and accurate laboratory analysis. The HI901W potentiometric titrator can perform acid/base, redox (ORP), complexometric, precipitation, non-aqueous, argentometric, and ion selective titrations. This powerful titrator dispenses the titrant, detects the endpoint, and performs all necessary calculations and graphs automatically. In addition to titration mode, the HI901W also operates as a fully functional pH, mV/ORP, and ion selective electrode (ISE) meter.

This titrator is supplied with standard wine methods or you can create your own. Methods (standard or user) can be easily transferred between titrators via USB flash drive or PC application.

### Optimized for Wine

Supplied with a full suite of standard wine methods, the Wine Titrator is optimized for winemakers. Packages are designed so that you'll have everything you need to produce quality wine. Our preloaded packages include the following methods:

Titrateable Acidity	Acid/Base Titration (pH)	Total SO <sub>2</sub> (AO)	Acid/Base Titration (pH)
Free SO <sub>2</sub> (Ripper)	Redox Titration (ORP)	Volatile Acid	Acid/Base Titration (pH)
Total SO <sub>2</sub> (Ripper)	Redox Titration (ORP)	YAN (Formal Number)	Acid/Base Titration (pH)
Free SO <sub>2</sub> (AO)	Acid/Base Titration (pH)	Reducing Sugar	Redox Titration (ORP)

## Features



- **Multiple titration types**
  - Paired with the right electrode from our sensor line, our potentiometric titrator can perform acid/base, redox (ORP), complexometric, precipitation, non-aqueous, argentometric, and titrations with an ion selective electrode.
- **Signal stability timing**
  - The signal stability feature monitors when the mV response of the titration reaction stabilizes before providing the next titrant dose. This ensures reliable measurement values throughout the length of a titration.

## Burettes and dosing system

- **Exchangeable burette system**
  - With Hanna's Clip-Lock burette, it only takes a few seconds to exchange titrants and reagents, preventing cross-contamination and saving time.
- **Multiple burette sizes**
  - The HI901W comes standard with a 25 mL burette but may be equipped with a 5 mL, 10 mL, or 50 mL burette.
- **Precision dosing pump**
  - Our unmatched 40,000 step piston driven pump is capable of dosing extremely small and precise volumes of titrant or reagent.



## Methods of analysis

- **Customizable methods**
  - The HI901W can store up to 100 user-defined or standard titration methods. Each method may be customized and optimized for performance based on application and user requirements.
- **Titration method support**
  - Onsite installation, training, and customization is available from one of our Applications or Service experts. Hanna offers continued support via phone or webinar for any questions you might have along the way.

## Titration capabilities

- **Dynamic titrant Dosing**
  - Dynamic dosing allows for timely and accurate titration results by relating the titrant volume dosed to the mV response from the titration reaction. This provides for larger doses near the beginning of a titration and smaller, more precise doses near the titration endpoint.
- **Equivalence endpoint detection**
  - Equivalence endpoint detection is critical in applications where fixed endpoints are not specified in standard methods. This endpoint indicates where the mV response from the titration is greatest with respect to the volume of titrant dosed.

## Data and storage

- **Customizable titration reports**
  - Each titration report is fully customizable so users can ensure they are storing and filing the appropriate data required for their application and procedures.
- **Effortless data transfer**
  - Data can easily be transferred to a USB flash drive or PC with the Hanna HI900PC application software.

## Connectivity and functionality

- **Multifunctional with four working modes**
  - The HI901W functions as a titrator, pH meter, mV/ORP meter, and ISE meter.
- **Multiple peripherals**
  - Users can print reports directly from the titrator using a standard parallel printer. An external monitor and keyboard may be attached for added versatility, as well as an analytical balance for automatic sample mass entry for titrations.

## Specifications

## HI901W Wine Titrator

pH	Range	-2.0 to 20.0 pH; -2.00 to 20.00 pH; -2.000 to 20.000 pH
	Resolution	0.1; 0.01; 0.001 pH
	Accuracy (@25°C/77°F)	±0.001 pH
	Calibration	up to five-point calibration, eight standard buffers and five custom buffers
mV	Range	-2000.0 to 2000.0 mV
	Resolution	0.1 mV
	Accuracy (@25°C/77°F)	±0.1 mV
	mV Calibration	single point offset
ISE	Range	1•10 <sup>-6</sup> to 9.99•10 <sup>10</sup>
	Resolution	1; 0.1; 0.01
	Accuracy (@25°C/77°F)	±0.5% monovalent; ±1% divalent
	ISE Calibration	up to five-point calibration, seven standard solutions and five user-defined standards
Temperature	Range	-20.0 to 120.0°C; -4.0 to 248.0°F; 253.2 to 393.2 K
	Resolution	0.1°C; 0.1°F; 0.1K
	Accuracy (@25°C/77°F)	±0.1°C; ±0.2°F; ±0.1K, excluding probe error
Other Specifications	Analog Board	Analog Board Provides: BNC (pH/mV/ISE) Input (1), Reference Input (1), Temperature Input (1), Stirrer Input (1)
	Analog Board(s) Capability	1
	Dosing Pump Capability	2
	Burette Included	1 (25 mL)
	Burette Sizes	5, 10, 25 and 50 mL
	Burette Resolution	1/40000
	Display Resolution	0.001 mL
	Dosing Accuracy	±0.1% of full burette volume
	Display	5.7" (320 x 240 pixel) backlit color LCD
	Languages	English, Portuguese, Spanish
	Methods	load up to 100 methods (standard and user-defined)
	Burette Auto-Detection	burette size is automatically recognized when inserted into the pump unit
	Programmable Stirrer	overhead propeller type, 200-2500 RPM, resolution 100 RPM
	Flow Rate	user-selectable from 0.1 mL/min to 2 x burette volume/min
	Temperature Compensation	manual (MTC) or automatic (ATC)
	Endpoint Determination	equivalence point (1st or 2nd derivative) or fixed pH/mV value
	Potentiometric Titrations	acid-base, redox, precipitation, complexometric, non-aqueous, argentometric
	Measurement Units	user-specified expression of concentration units to suit specific calculation requirements
	Real Time & Stored Graphs	mV-volume or pH-volume titration curve, 1st derivative curve or 2nd derivative curve pH mode, mV mode or ISE mode: pH/mV/concentration versus time
	Data Storage	up to 100 titration and pH/mV/ISE reports
	USB Host (Side)	flash drive compatibility for transfers of methods and reports
	Peripherals (Rear)	connections for VGA display, PC-keyboard, parallel printer, USB device input, RS232
	GLP Conformity	instrumentation data storage and printing capabilities
	Operating Environment	10 to 40°C (50 to 104°F), up to 95% RH
	Storage Environment	-20 to 70°C (-4 to 158°F), up to 95% RH
	Power	100-240 VAC "-01" models, US plug (type A) "-02" models, European plug (type C)
	Dimensions	390 x 350 x 380 mm (15.3 x 13.8 x 14.9 in)
Weight	approximately 9 kg (20 lbs.) with one pump, stirrer and sensors	
Ordering Information	<b>HI901W-01</b> (115V) and <b>HI901W-02</b> (230V) includes titrator with one analog board, overhead propeller stirrer with stand, 25 mL glass burette, dosing pump, temperature sensor, USB cable, USB flash drive and PC software.	



## HI901W Automatic Titration System Solutions

### Yeast Available Nitrogen (YAN) titration solution

Reagent Code	Description
<b>HI70456</b>	sodium hydroxide solution (0.1 N), 1 L
<b>HI70457</b>	sodium hydroxide solution (1 N), 1 L

### Titrateable acidity titration solution

Reagent Code	Description
<b>HI70456</b>	sodium hydroxide solution (0.1 N), 1 L

## Volatile acidity (VA)

Acetic acid is commonly formed during yeast growth in the early stages of fermentation. The rate and amount of acetic acid formed is partially dependent on the pH, sugar levels, available nitrogen, and temperature of the system. Typical VA levels post-fermentation range from 0.2–0.4 g/L. Any level higher could indicate microbial involvement and potential spoilage.

### Volatile acidity titration solution

Reagent Code	Description
<b>HI70456</b>	sodium hydroxide solution (0.1 N), 1 L
<b>HI70432</b>	hydrogen peroxide solution (3%), 25 mL

## HI901W Automatic Titration System Accessories

Code	Description
<b>HI900100</b>	dosing pump
<b>HI900150</b>	50 mL burette assembly (includes syringe, aspiration, and dispensing tubes)
<b>HI900125</b>	25 mL burette assembly (includes syringe, aspiration, and dispensing tubes)
<b>HI900110</b>	10 mL burette assembly (includes syringe, aspiration, and dispensing tubes)
<b>HI900105</b>	5 mL burette assembly (includes syringe, aspiration, and dispensing tubes)
<b>HI900250</b>	50 mL burette syringe
<b>HI900225</b>	25 mL burette syringe
<b>HI900210</b>	10 mL burette syringe
<b>HI900205</b>	5 mL burette syringe
<b>HI900260</b>	3-way valve (includes 3 gaskets and 2 screws)
<b>HI900270S</b>	aspiration tube set with 316 stainless steel fitting (includes blue protection tube, gasket, and tube lock)
<b>HI900280S</b>	dispensing tube set with 316 stainless steel fitting (includes standard dispensing tip, blue protection tube, gasket, and tube lock)
<b>HI900301</b>	overhead stirrer assembly (includes overhead stirrer and 3 propellers)
<b>HI900302</b>	replacement propellers (3)
<b>HI900303</b>	PVDF replacement propellers (3) for organic solvents
<b>HI900304</b>	Replacement shearing type polycarbonate propeller (1) for HI901 and HI902 overhead stirrer
<b>HI900310</b>	overhead electrode holder (includes overhead stirrer without electronics or propeller)
<b>HI900320</b>	stirrer stand
<b>HI7662-T</b>	temperature probe
<b>HI900942</b>	tool for burette cap removal
<b>HI900946</b>	power adapter 120VAC to 24VDC
<b>HI900947</b>	power adapter 220VAC to 24VDC
<b>HI920013</b>	USB cable (HI902C only)
<b>HI900805</b>	HI902C1/Hi902C2 Design, Installation, Operation, and Performance Qualification (DQ/IQ/OQ/PQ) Documentation

HI84534

# Titratable Acidity Titrator and pH Meter

for Vinegar

- Piston driven pump with dynamic dosing
  - For highly accurate, repeatable results
- Two endpoints and two ranges
- CAL Check™
  - Alerts users to potential problems during calibration such as contaminated buffers or a dirty/broken pH electrode
- Log-on-demand
  - Log data up to 400 samples (200 for titration; 200 for pH/mV)
- Graphic mode/exportable data
  - Displays in-depth data on titration, which can then be stored and exported to either a USB drive or PC using the USB connection
- Automatic stirrer speed control
  - Maintains stirrer speed at approximately 600 rpm regardless of viscosity of solution
- GLP features
  - Date, time, offset, slope and buffers used
- Easy-to-use interface
  - User intuitive design with large keys and easy to navigate screens
- HELP features
  - Dedicated HELP key for content sensitive help
- pH/mV meter
  - Doubles as a benchtop pH meter



## An Easy-to-Use, Fast and Affordable All-in-one Solution

The HI84534 is a low-cost, easy to use automatic minititrator and pH meter designed for the rapid and accurate analysis of Total Titratable Acidity in Vinegar. The HI84534 minititrator is a valuable tool because of its ability to eliminate subjective factors including color indicators, errors in mathematical calculations or erratic titrant additions, it will quickly become a valuable acidity analysis tool of vinegar.

The HI84534 incorporates a precise piston dosing system, which allows for a highly accurate determination of the amount of titrant used. It is also capable of dynamic dosing, making testing both faster and more accurate. Pump calibrations are performed with the provided Hanna standard and help assure the accuracy of the measurement.

An intuitive interface makes the instrument simple to use and the dedicated HELP key

guides the user through set-up, calibration status, and troubleshooting.

This mini titrator includes a pre-programmed analysis method based on the Standard Methods of Water and Wastewater Determination. It uses a powerful algorithm which analyzes the shape of the electrode response in order to determine when the titration reaction has reached completion.

This mini titrator is also designed to be used as a benchtop pH/mV meter. The CAL Check function not only ensures an accurate pH reading when the HI84534 is used as a pH meter but also an accurate titration since the endpoint is determined by a set pH value.

## Vinegar

Vinegar is made when acetic acid bacteria is added to an alcohol beverage such as wine. The bacteria will eat the ethanol and produce a tart, pungent liquid known as acetic acid. The acetic acid concentration in vinegar typically ranges from 4 to 9% (w/v). The pH of vinegar

is typically between 2.5 to 3.0, depending on the acetic acid concentration.

Vinegar can be made out of anything that has alcohol (ethanol) in it, including wine, beer, and hard cider. The type of vinegar depends on what liquid the ethanol has been fermented in. White vinegar is made a vodka type liquor made from grain, while apple cider vinegar is made from apples and balsamic vinegar is made from grape must. Outside of the United States popular vinegars include rice, coconut and cane. Vinegars are commonly used in food preparation, medicine, agriculture and in cleaning solutions.

The titratable acidity of vinegar is determined by titrating the sample with a strong base to a fixed pH. The end point is determined by the potentiometric input and the results are typically expressed as % (g/100mL) or g/L acetic acid. The HI84534 minititrator method is based on the Official Methods of Analysis of AOAC International.

## On-screen Features

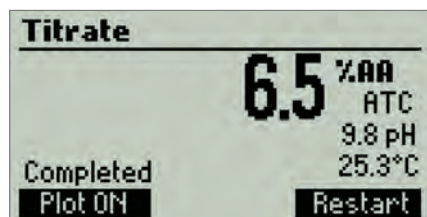

### Easy and clear measurement

The HI84534 is a single parameter titrator designed to measure acidity in a few easy steps. The HI84534 displays the results directly on the screen in user-selectable units.

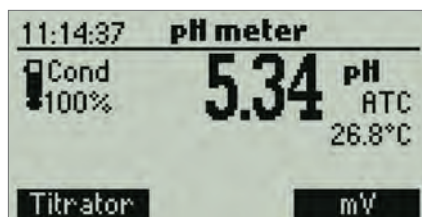

### pH meter with electrode condition on display

The HI84534 also functions as a pH meter. The HI84534 also displays the electrode condition on the LCD using Hanna's exclusive electrode diagnostics.

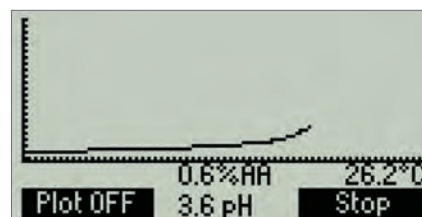

### Titration curve displayed on screen

The HI84534 offers real time graphing of the titration curve on the LCD.

## Specifications

### HI84534

Titrator	Range	0.3 to 10.0 % w/v (g/100mL) as acetic acid 3 to 100 g/L as acetic acid
	Resolution	0.1%, 1g/L
	Accuracy (@25°C/77°F)	3% of reading or ± 0.1 % , whichever is greater 3% of reading or ± 1 g/L, whichever is greater
	Sample Volume	1 mL
	Titration Method	Acid-base titration
	Principle	Fixed end point titration to pH 8.2
	Pump Speed	10 mL/min
	Stirring Speed	600 rpm
Data storage	up to 200 titrations	
pH/mV Meter	pH Range	-2.0 to 16.0 pH / -2.00 to 16.00 pH
	pH Resolution	0.1 pH / 0.01 pH
	pH Accuracy (@25°C/77°F)	± 0.01 pH
	pH Calibration	one, two or three-point calibration; four available buffers (pH 4.01, 7.01, 8.20, 10.01)
	mV Range	-2000.0 to 2000.0 mV
	mV Resolution	0.1 mV
	mV Accuracy (@25°C/77°F)	± 1.0 mV
Data storage	up to 200 data points (pH or mV)	
Temperature	Range	-20.0 to 120.0°C; -4.0 to 248.0°F
	Resolution	0.1°C; 0.1°F
	Accuracy (@25°C/77°F)	±0.4°C; ±0.8°F without probe error
	Compensation	manual or automatic
Additional Specifications	pH Electrode	HI1131B glass body pH electrode with BNC connector and 1 m (3.3') cable (included)
	Temperature Probe	HI7662-T stainless steel temperature probe with 1 m (3.3') cable (included)
	Connectivity	(1) Type-B USB for PC interface, (1) Type-A USB for storage
	Environment	0 to 50°C (32 to 122 °F); max 95% RH non-condensing
	Power Supply	12 VDC power adapter
	Dimensions	235 x 200 x 150 mm (9.2 x 7.9 x 5.9")
	Weight	1.9 kg (67.0 oz.)
Ordering Information	<b>HI84534-01</b> (115V) and <b>HI84534-02</b> (230V) are supplied with HI1131B pH electrode, HI7662-T temperature probe, HI7082 electrode fill solution, HI84534-70 reagent kit for water analysis, 100 mL beakers (2), dosing pump valve, 5 mL syringe, 1 mL plastic pipette, tube set (aspiration tube with titrant bottle cap and dispensing tube with tip), stir bar, power adapter, instruction manual and quality certificate.	

HI84530

# Total Titratable Acidity Titrator and pH Meter

for Water Analysis

- Piston driven pump with dynamic dosing
  - For highly accurate, repeatable results
- Two endpoints and two ranges
- CAL Check™
  - Alerts users to potential problems during calibration such as contaminated buffers or a dirty/broken pH electrode
- Log-on-demand
  - Log data up to 400 samples (200 for titration; 200 for pH/mV)
- Graphic mode/exportable data
  - Displays in-depth data on titration, which can then be stored and exported to either a USB drive or PC using the USB connection
- Automatic stirrer speed control
  - Maintains stirrer speed at approximately 600 rpm regardless of viscosity of solution
- GLP features
  - Date, time, offset, slope and buffers used
- Easy-to-use interface
  - User intuitive design with large keys and easy to navigate screens
- HELP features
  - Dedicated HELP key for content sensitive help
- pH/mV meter
  - Doubles as a benchtop pH meter



## An Easy-to-Use, Fast and Affordable All-in-one Solution

The HI84530 is an easy to use, fast and affordable mini automatic titrator with a pH meter designed for the rapid and accurate analysis of Total Titratable and Strong Acidity in water. This new generation of mini automatic titrator improves upon the titrant delivery system and measuring ranges for increased accuracy compared to previous models. This meter reflects Hanna's years of experience as a manufacturer of analytical instruments.

The HI84530 incorporates a precise piston dosing system, which allows for a highly accurate determination of the amount of titrant used. It is also capable of dynamic dosing, making testing both faster and more

accurate. Pump calibrations are performed with the provided Hanna standard and help assure the accuracy of the measurement.

An intuitive interface makes the instrument simple to use and the dedicated HELP key guides the user through set-up, calibration status, and troubleshooting.

This mini titrator includes a pre-programmed analysis method based on the Standard Methods of Water and Wastewater Determination. It uses a powerful algorithm which analyzes the shape of the electrode response in order to determine when the titration reaction has reached completion.

This mini titrator is also designed to be used as a benchtop pH/mV meter. The CAL Check function not only ensures an accurate pH

reading when the HI84530 is used as a pH meter but also an accurate titration since the endpoint is determined by a set pH value.

## Total Titratable Acidity

Water acidity is an important parameter to monitor as it can affect the corrosive capacity of a water, chemical reaction rates and biological processes. Acidity can also be used to monitor pollution in wastewater and drinking water.

Total titratable acidity is a measure of all of the acid compounds present in a sample. Many factors can contribute to the acidity of water in a sample, including strong acids (hydrochloric, sulfuric, nitric, etc.), weak acids (organic acids) and other acidic components (aluminum, iron, etc.).



## On-screen Features

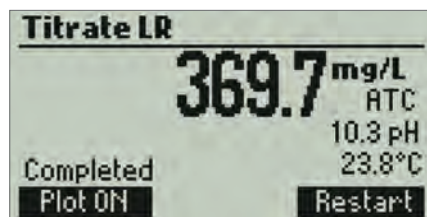

### Easy and clear measurement

The HI84530 is a single parameter titrator designed to measure total acidity in a few easy steps. The HI84530 displays the results directly on the screen in user-selectable units.



### pH meter with electrode condition on display

The HI84530 also functions as a pH meter. The HI84530 also displays the electrode condition on the LCD using Hanna's exclusive electrode diagnostics.

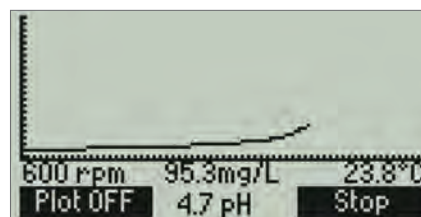

### Titration curve displayed on screen

The HI84530 offers real time graphing of the titration curve on the LCD.

## Specifications

### HI84530

Titrator	Range (as CaCO <sub>3</sub> )	Low Range: 15.0 to 400.0 mg/L; 0.3 to 8.0 meq/L High Range: 300 to 4000 mg/L; 6.0 to 80.0 meq/L
	Resolution	Low Range: 0.1 mg/L / 0.1 meq/L High Range: 1 mg/L / 0.1 meq/L
	Accuracy (@25°C/77°F)	Low Range: ±0.5 mg/L or 3% of reading, whichever is greater High Range: ±15 mg/L or 3% of reading, whichever is greater
	Titration Method	acid-base titration, total acidity / strong acidity
	Titration Principle	fixed endpoint titration: 8.30 pH (phenolphthalein) or 3.7 pH (Methyl Orange)
	Pump Speed	10 mL/min
	Stirring Speed	600 rpm
pH Meter	Range	-2.0 to 16.0 pH / -2.00 to 16.00 pH
	Resolution	0.1 pH / 0.01 pH
	Accuracy (@25°C/77°F)	± 0.01 pH
	Calibration	one, two or three-point calibration; four available buffers (pH 4.01, 7.01, 8.30, 10.01)
	Temperature Compensation	manual or automatic from -20 to 120 °C (-4 to 248 °F)
mV Meter	Range	-2000.0 to 2000.0 mV
	Resolution	0.1 mV
	Accuracy (@25°C/77°F)	± 1.0 mV
Temperature	Range	-20.0 to 120.0°C; -4.0 to 248.0°F; 253.2 to 393.2 K
	Resolution	0.1°C; 0.1°F; 0.1 K
	Accuracy (@25°C/77°F)	±0.4°C; ±0.8°F; ±0.4 K
Additional Specifications	Logging	up to 400 samples (200 pH/mV, 200 titration)
	pH Electrode	HI1131B glass body pH electrode with BNC connector and 1 m (3.3') cable (included)
	Temperature Probe	HI7662-T stainless steel temperature probe with 1 m (3.3') cable (included)
	Connectivity	(1) Type-B USB for PC interface, (1) Type-A USB for storage
	Environment	0 to 50 °C (32 to 122 °F); max 95% RH non-condensing
	Power Supply	12 VDC power adapter
	Dimensions	235 x 200 x 150 mm (9.2 x 7.9 x 5.9")
	Weight	1.9 kg (67.0 oz.)
Ordering Information	<b>HI84530-01</b> (115V) and <b>HI84530-02</b> (230V) are supplied with HI1131B pH electrode, HI7662-T temperature probe, HI7082 electrode fill solution, HI84530-70 reagent kit for water analysis, 100 mL beakers (2), dosing pump valve, 5 mL syringe, 1 mL plastic pipette, tube set (aspiration tube with titrant bottle cap and dispensing tube with tip), stir bar, power adapter, instruction manual and quality certificate.	

HI84531

# Titrateable Alkalinity Titrator and pH Meter

for Water Analysis

- Piston driven pump with dynamic dosing
  - For highly accurate, repeatable results
- CAL Check™
  - Alerts users to potential problems during calibration such as contaminated buffers or dirty/broken pH electrodes
- Log-on-demand
  - Log data up to 400 samples (200 for titration; 200 for pH/mV)
- Graphic mode/exportable data
  - Displays in-depth data on titration, which can then be stored and exported to either a USB drive or PC using the USB connection
- Automatic stirrer speed control
  - Maintains stirrer speed at approximately 600 rpm regardless of viscosity of solution
- GLP features
  - Date, time, offset, slope and buffers used
- Easy-to-use interface
  - User intuitive design with large keys and easy to navigate screens
- HELP features
  - Dedicated HELP key for content sensitive help
- pH/mV meter
  - Doubles as a benchtop pH meter



## An Easy-to-Use, Fast and Affordable All-in-one Solution

The HI84531 is a dedicated mini titrator and pH meter designed for low to high levels of alkalinity. It performs a potentiometric titration with a pH electrode to determine total titrateable alkalinity or strong alkalinity in water. A titrant is slowly added to the sample while the pH and temperature are carefully monitored. The software analyzes the resulting titration curve and calculates the volume of titrant required to reach the endpoint. The user can choose either to measure strong alkalinity with a 8.30 pH endpoint (known as phenolphthalein alkalinity) or total alkalinity with a 4.50 pH endpoint (known as bromocresol green-methyl red alkalinity).

The dispensed titrant volume is used to automatically calculate the alkalinity, which can be displayed in mg/L or meq/L as CaCO<sub>3</sub>.

This mini titrator is also designed to be used as a benchtop pH/mV meter. The CAL Check function not only ensures an accurate pH reading when the HI84531 is used as a pH meter but also an accurate titration since the endpoint is determined by a set pH value.

## Total Alkalinity

Total titrateable alkalinity is a measure of primarily three types of alkalinities present in a water sample: hydroxide, carbonate and bicarbonate. Alkalinity in water can be the result of contributions from common

chemicals, including carbonate, bicarbonate, hydroxide, phosphates, borate and organic acid salts.

The alkalinity of a water sample indicates its ability to resist pH change. The amount of alkalinity in water is mostly due to the bicarbonate/carbonate present. A low alkalinity level indicates that the water is susceptible to pH changes, while a high alkalinity level indicates that the water will be able to resist pH changes. Alkalinity can also be used to determine the corrosive capacity of water and can provide an estimation of water hardness.

## On-screen Features

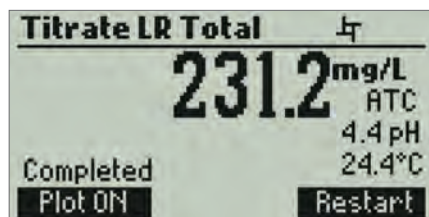

### Easy and clear measurement

These titrators are designed to measure in a few easy steps. The results are displayed directly on the screen.

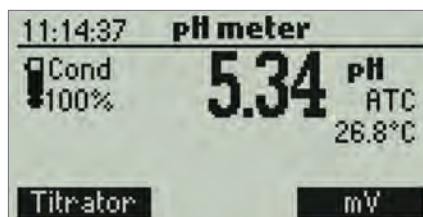

### Electrode condition on display

These titrators feature a pH meter which also displays the electrode condition on the LCD.

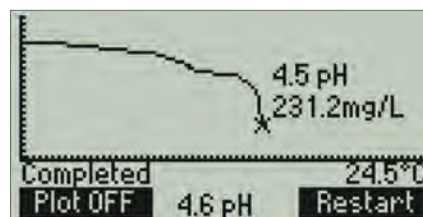

### Titration Curve Displayed On Screen

The HI84531 offers real time graphing of the titration curve on the LCD.

## Specifications

### HI84531

Titrator	Range (as CaCO <sub>3</sub> )	Low Range: 30.0 to 400.0 mg/L; 0.6 to 8.0 meq/L High Range: 300 to 4000 mg/L; 6.0 to 80.0 meq/L
	Resolution	Low Range: 0.1 mg/L (ppm); 0.1 meq/L High Range: 1 mg/L (ppm); 1 meq/L
	Accuracy (@25°C/77°F)	Low Range: ±1 mg/L or 3% of reading, whichever is greater High Range: ±10 mg/L or 3% of reading, whichever is greater
	Titration Method	acid-base titration (strong alkalinity /total alkalinity)
	Titration Principle	endpoint titration : 8.30 pH (phenolphthalein) / 4.50 pH (bromcresol green-methyl red)
	Pump Volume	10 mL/min
	Stirring Speed	600 rpm
pH	Range	-2.0 to 16.0 pH / -2.00 to 16.00 pH
	Resolution	0.1 pH / 0.01 pH
	Accuracy (@25°C/77°F)	± 0.01 pH
	Calibration	one, two or three-point calibration; four available buffers (4.01, 7.01, 8.30, 10.01)
	Temperature Compensation	manual or automatic
mV	Range	-2000.0 to 2000.0 mV
	Resolution	0.1 mV
	Accuracy (@25°C/77°F)	± 1.0 mV
Temperature	Range	-20.0 to 120.0°C; -4.0 to 248.0°F; 253.2 to 393.2 K
	Resolution	0.1°C; 0.1°F; 0.1 K
	Accuracy	±0.4°C; ±0.8°F; ±0.4 K
Additional Specifications	Logging	up to 400 samples (200 pH/mV, 200 titration)
	pH Electrode	HI1131B glass body pH electrode with BNC connector and 1 m (3.3') cable (included)
	Temperature Probe	HI7662-T stainless steel temperature probe with 1 m (3.3') cable (included)
	Connectivity	(1) Type-B USB for PC interface, (1) Type-A USB for storage
	Environment	0 to 50 °C (32 to 122 °F); max 95% RH non-condensing
	Power Supply	12 VDC adapter
	Dimensions	235 x 200 x 150 mm (9.2 x 7.9 x 5.9")
	Weight	1.9 kg (67.0 oz.)
Ordering Information	<b>HI84531-01</b> (115V) and <b>HI84531-02</b> (230V) are supplied with HI1131B pH electrode, HI7662-T temperature probe, HI7082 electrode fill solution, HI84531-70 reagent kit for water analysis, 100 mL beakers (2), dosing pump valve, 5 mL syringe, 2000 µL automatic pipette (1) with plastic tips (2), 20 mL beakers (2), tube set (aspiration tube with titrant bottle cap and dispensing tube with tip), stir bar, power adapter, instruction manual and quality certificate.	

HI84529

# Titrateable Acidity Mini Titrator and pH Meter

for the Dairy Industry

- **Piston-driven pump with dynamic dosing**
  - For highly accurate, repeatable results
- **CAL Check™**
  - Alerts users to potential problems during calibration such as contaminated buffers or dirty electrodes
- **Log-on-demand**
  - Log data up to 400 samples (200 for titration; 200 for pH/mV)
- **Graphic mode/exportable data**
  - Displays in-depth data on titration, which can then be stored and exported to either a USB drive or PC using the USB connection
- **Automatic stirrer speed control**
  - Maintains stirrer speed regardless of viscosity of solution
- **GLP features**
  - Date, time, offset, slope and buffers used
- **Application-specific FC260B half-cell pH electrode**
  - This electrode is designed to measure all types of dairy related products
- **HI5315 double junction half-cell reference electrode**
  - Features a plunger design to clear any clogging of the outer junction
- **Help features**
  - Dedicated HELP key for content sensitive help
- **pH/mV meter**
  - Doubles as a benchtop pH meter



## An Easy-to-Use, Fast and Affordable All-in-one Solution

The HI84529 is an easy-to-use, fast and affordable mini automatic titrator and pH meter designed for testing acidity levels in dairy products. This new generation of mini automatic titrator improves upon the titrant delivery system and measuring ranges for increased accuracy compared to previous models. This meter reflects Hanna's years of experience as a manufacturer of analytical instruments.

This mini titrator includes a pre-programmed analysis method designed for acidity measurements for dairy analysis. It uses

a powerful algorithm which analyzes the electrode response in order to determine when the titration reaction has reached completion. By simply pressing the START key, the HI84529 automatically performs a pH endpoint titration and displays results immediately in a choice of units.

## Acidity Measurement and its Significance in the Dairy Industry

There are two fundamentally different measurements of dairy products: titratable acidity and pH. pH is a measurement of hydrogen ion concentration while titratable

acidity is the neutralizing capacity of a dairy product with NaOH.

An increase in acidity can be caused by bacteria formation. Monitoring acidity is a way of determining the quality and freshness of dairy products. Acidity is determined by a pH endpoint titration using sodium hydroxide (NaOH), and is defined as the consumption necessary to shift the pH value from 6.6 (corresponding to fresh milk) to a pre-determined pH value. While pH 7.0 is the actual point of neutralization, phenolphthalein is commonly employed as a color indicator to determine the endpoint of reaction; with phenolphthalein, a color change occurs at pH 8.3. Titratable acidity

is expressed in a variety of units based on the one which reflects the titration method and strength of NaOH used during titration.

Titrate acidity can be expressed in several units. Each of these units corresponds to a specific procedure used to titrate dairy products.

**% Lactic Acid (% l.a.):** is determined by titrating a 20 mL or 20 g sample diluted with twice its volume of deionized or distilled water with 0.1 M sodium hydroxide to a phenolphthalein endpoint.

**Degree Soxhlet Henkel (°SH):** is determined by titrating a 50 mL sample with 0.1 M sodium hydroxide to a phenolphthalein endpoint.

**Degree Dornic (°D):** is determined by titrating a 100 mL sample with N/9 sodium hydroxide to a phenolphthalein endpoint.

**Degree Thörner:** is determined by titrating a 10 mL sample diluted with twice its volume of deionized or distilled water with 0.1 M sodium hydroxide to a phenolphthalein endpoint.

From:	To:	Divide By:
%l.a.	°SH	0.0225
%l.a.	°D	0.0100
%l.a.	°Th	0.0090

## Eliminate Subjectivity and Increase Efficiency

The HI84529 Mini Titrator eliminates the subjective endpoint color change detection determined by the human eye, and instead employs the sensitivity and accuracy of a pH sensor. The titration method is a potentiometric endpoint determination using a pre-determined pH value.

The titratable acidity values will vary depending on the method used. Select Low 50 to titrate a non diluted sample, or select low 20/High 20 to titrate 20 mL or 20 g samples that are diluted with twice its volume or deionized or distilled water. The HI84529 uses methods based on AOAC International and Standard Methods for the Examination of Dairy Products. Both of these methods report titratable acidity as % lactic acid, a rough conversion factor can be used to convert the results to the other available units.

The HI84529 can be customized to meet the needs of any dairy analysis lab. Samples can be titrated by weight or volume, diluted or non-diluted (low range only) and titrated to a fixed pH endpoint that can be adjusted by the user.

Specifications	HI84529	
Titrator	Range	Low Range: %l.a.: 0.01 to 0.20; °SH: 0.4 to 8.9; °D: 1.0 to 20.0; °Th: 1.1 to 22.2 High Range: %l.a.: 0.1 to 2.0; °SH: 4.4 to 88.9; °D: 10 to 200; °Th: 11.1 to 222.2
	Resolution	Low Range: %l.a.: 0.01; °SH: 0.1; °D: 0.1; °Th: 0.1 High Range: %l.a.: 0.1; °SH: 0.1; °D: 1; °Th: 0.1
	Accuracy (@25°C/77°F)	Low Range: ± 0.01 %l.a. High Range: ± 0.1 %l.a.
	Method	acid-base titration
	Sample Size (LR 20)	20 mL or 20 g
	Sample Size (LR 50)	50 mL or 50 g
	Sample Size (HR 20)	20 mL or 20 g
	Principle	endpoint titration, adjustable (pH 8.0 - 8.7 in 0.1 increments)
	Pump Speed	10 mL/min
	Stirring Speed	800 (Low Range) / 1000 (High Range)
pH Meter	Range	-2.0 to 16.0 pH / -2.00 to 16.00 pH
	Resolution	0.1 pH / 0.01 pH
	Accuracy (@25°C/77°F)	±0.01 pH
	Calibration	one, two or three-point calibration; four available buffers (pH 4.01, 6.00, 8.30, 10.01)
	Temperature Compensation	manual or automatic
mV Meter	Range	-2000.0 to 2000.0 mV
	Resolution	0.1 mV
	Accuracy	± 1.0 mV
Temperature	Range	-20.0 to 120.0°C; -4.0 to 248.0°F; 253.2 to 393.2 K
	Resolution	0.1°C; 0.1°F; 0.1 K
	Accuracy	±0.4°C; ±0.8°F; ±0.4 K
Additional Specifications	Logging Data	up to 400 samples (200 pH/mV, 200 titration)
	Electrodes	FC260B pH electrode with 1 m (3.3') cable (included), HI5315 reference probe with 1 m (3.3') cable (included)
	Temperature Probe	HI7662-T stainless steel temperature probe with 1 m (3.3') cable (included)
	Connectivity	(1) Type-B USB for PC interface, (1) Type-A USB for storage
	Environment	0 to 50°C (32 to 122°F); RH max 95% non-condensing
	Power Supply	12 VDC power adapter (included)
	Dimensions	235 x 200 x 150 mm (9.2 x 7.9 x 5.9")
	Weight	1.9 kg (67.0 oz.)
Ordering Information	<b>HI84529-01</b> (115V) and <b>HI84529-02</b> (230V) are supplied with HI84529-70 Reagent Kit for titratable acidity in dairy products, FC260B pH electrode, HI5315 reference electrode, HI7662-M temperature probe, HI7072 fill solution (30 mL), HI700640 cleaning solution for milk deposits (2 x 20 mL), capillary dropper pipette, 100 mL beakers (2), dosing pump valve, 5 mL syringe, 1 mL plastic pipette, tube set (aspiration tube with titrant bottle cap and dispensing tube with tip), stir bar, power adapter, instruction manual and quality certificate.	

HI84532

# Titratable Acidity Mini Titrator and pH Meter

for Fruit Juice

- **Piston-driven pump with dynamic dosing**
  - For highly accurate, repeatable results
- **CAL Check™**
  - Alerts users to potential problems during calibration such as contaminated buffers or dirty/broken electrodes
- **Log-on-demand**
  - Log data up to 400 samples (200 for titration; 200 for pH/mV)
- **Graphic mode/exportable data**
  - Displays in-depth data on titration, which can then be stored and exported to either a USB drive or PC using the USB connection
- **Automatic stirrer speed control**
  - Maintains stirrer speed at 600 RPM regardless of viscosity of solution
- **GLP features**
  - Date, time, offset, slope and buffers used
- **Easy-to-use interface**
  - Intuitive design with large keys and easy to navigate screens
- **Help features**
  - Dedicated HELP key for content sensitive help
- **pH/mV meter**
  - Doubles as a benchtop pH meter



## An Easy-to-Use, Fast and Affordable All-in-one Solution

The HI84532 digital automatic mini titrator and pH meter is designed for measuring the concentration of titratable hydrogen ions contained in fruit juice samples by neutralization with a strong base solution to a fixed pH endpoint as according to the Official Methods of Analysis of AOAC International. This new generation of mini automatic titrator improves upon the titrant delivery system and measuring ranges for increased accuracy compared to previous models. This meter reflects Hanna's years of experience as a manufacturer of analytical instruments.

A clear and intuitive user interface allows users to easily navigate the HI84532's menus and functions. The HELP key located on the keypad aids in on-screen set-up, status and troubleshooting.

The HI84532 incorporates a precise piston dosing system, which allows for a highly accurate determination of the amount of titrant used. It is capable of dynamic dosing, making testing both faster and more accurate. Pump calibrations, performed with the provided Hanna standards, help assure the measurement accuracy.

This mini titrator is also designed to be used as a benchtop pH/mV meter. The CAL Check function not only ensures an accurate pH reading when the HI84532 is used as a pH meter but also an accurate titration since the endpoint is determined by a set pH value.

## The Importance of Titratable Acidity

Titratable acidity is an important parameter in determining fruit maturity and sour taste in citrus fruits. The maturity of fruit is one of

the most important factors to determine how well fruit will store and how it will taste. For some fruits, governmental quality standards (based on titratable acidity or the ratio of total soluble solids (°Brix) to titratable acidity) are in place to protect consumers. Immature fruit will normally have a low sugar to acid ratio as compared to mature fruit that will have a high sugar to acid ratio.

The HI84532 measures the concentration of titratable acids contained in fruit juice samples by neutralization with a strong base solution to a fixed pH. This value includes all the substances of an acidic nature in the fruit juice including: free hydrogen ions, organic acids and acid salts. Titratable acidity is expressed as g/100 mL of the predominant acid. The predominant acids in fruit depend on the type of fruit being tested and include citric acid, tartaric acid, and malic acid.

## On-screen Features

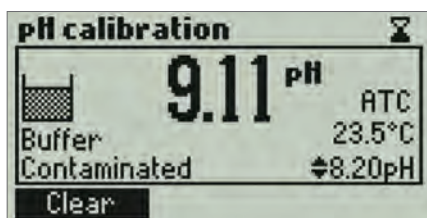

### CAL Check™

CAL Check is a Hanna exclusive process for checking the condition of pH electrodes for accurate measurements

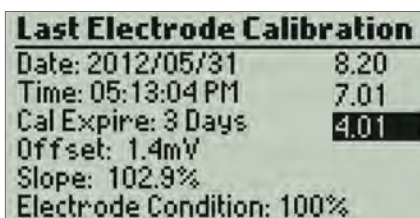

### GLP

The GLP feature records electrode and pump calibration data to help keep measurements accurate and reliable.

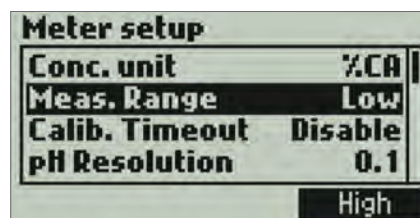

### Setup screens

The LCD features an easy to use setup screen.

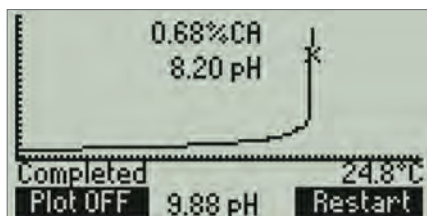

### Titration curve displayed on screen

The HI84532 offers real time graphing of the titration curve on the LCD.

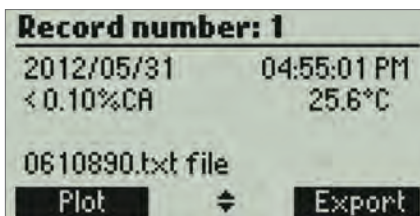

### Log and recall data

The HI84532 can log up to 400 samples (200 for titration; 200 for pH/mV) and recall or export data to a USB drive or PC.

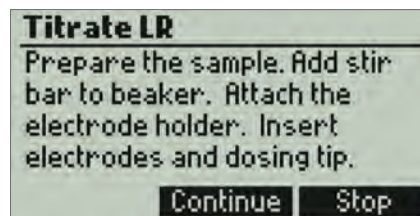

### Tutorial and help screens

Accessing the tutorial menu provides helpful information during calibration and titration.

### Specifications

### HI84532

Titrator	Titrateable Acidity Range	Low Range (5 mL sample): g/100 mL as citric acid: 0.10 to 2.00% CA; g/100 mL as tartaric acid: 0.11 to 2.35% TA; g/100 mL as malic acid: 0.10 to 2.09% MA High Range (5 mL sample): g/100 mL as citric acid: 1.00 to 10.00% CA; g/100 mL as tartaric acid: 1.17 to 11.72% TA; g/100 mL as malic acid: 1.05 to 10.47% MA
	Titrateable Acidity Resolution	0.01%
	Accuracy (@25°C/77°F)	± 0.02% CA or 3% of reading whichever is greater
	Titration Method	acid-base titration
	Principle	endpoint titration: 8.1 pH
	Pump Speed	10 mL/min
pH Meter	Stirring Speed	600 rpm
	Range	-2.0 to 16.0 pH / -2.00 to 16.00 pH
	Resolution	0.1 pH / 0.01 pH
	Accuracy (@25°C/77°F)	±0.01 pH
	Calibration	one, two or three-point calibration; four available buffers (4.01, 7.01, 8.20, 10.01)
mV Meter	Temperature Compensation	manual or automatic
	Range	-2000.0 to 2000.0 mV
	Resolution	0.1 mV
Temperature	Accuracy	± 1.0 mV
	Range	-20.0 to 120.0°C; -4.0 to 248.0°F; 253.2 to 393.2 K
	Resolution	0.1°C; 0.1°F; 0.1 K
Additional Specifications	Accuracy (@25°C/77°F)	±0.4°C; ±0.8°F; ±0.4 K
	Logging Data	up to 400 samples (200 pH/mV, 200 titration)
	Electrode	HI1131B glass body pH electrode with BNC connector and 1 m (3.3') cable
	Temperature Probe	HI7662-T stainless steel temperature probe with 1 m (3.3') cable (included)
	Connectivity	(1) Type-B USB for PC interface, (1) Type-A USB for storage
	Environment	0 to 50°C (32 to 122°F); RH max 95% non-condensing
	Power Supply	12 VDC power adapter (included)
	Dimensions	235 x 200 x 150 mm (9.2 x 7.9 x 5.9")
	Weight	1.9 kg (67.0 oz.)
	Ordering Information	HI84532-01 (115V) and HI84532-02 (230V) are supplied with HI84532-70 reagent Kit for titrateable acidity in fruit juice, HI1131B pH electrode, HI7662-T temperature probe, HI7082 electrode fill solution (30 mL), 100 mL beakers (2), 20 mL beaker, tube set (aspiration tube with titrant bottle cap and dispensing tube with tip), dosing pump valve, 5 mL syringe, 1 mL plastic pipette, stir bar, power adapter, instruction manual and quality certificate.

HI84533

# Formol Number Mini Titrator and pH Meter

for Wines and Fruit Juices

- **Piston driven pump with dynamic dosing**
  - For highly accurate, repeatable results
- **CAL Check™**
  - Alerts users to potential problems during calibration such as contaminated buffers or dirty/broken pH electrode
- **Log-on-demand**
  - Log data up to 400 samples (200 for titration; 200 for pH/mV)
- **Graphic mode/exportable data**
  - Displays in-depth data on titration, which can then be stored and exported to either a USB drive or PC using the USB connection
- **Automatic stirrer speed control**
  - Maintains stirrer speed at 600 RPM regardless of viscosity of solution
- **GLP features**
  - Date, time, offset, slope and buffers used
- **Easy-to-use interface**
  - Intuitive design with large keys and easy to navigate screens
- **Help features**
  - Dedicated HELP key for content sensitive help
- **pH/mV meter**
  - Doubles as a benchtop pH meter



## An Easy-to-Use, Fast and Affordable All-in-one Solution

The HI84533 is an easy to use, fast and affordable mini automatic titrator designed for the rapid and accurate determination of formol number in wines or fruit juices. This new generation of mini automatic titrator improves upon the titrant delivery system and measuring ranges for increased accuracy compared to previous models. This meter reflects Hanna's years of experience as a manufacturer of analytical instruments.

The HI84533 incorporates a precise piston dosing system which allows for a highly accurate determination of the amount of titrant used. It is also capable of dynamic dosing, making testing both faster and more accurate. A pump calibration performed with the supplied Hanna standard help assure the accuracy of the measurement.

This mini titrator includes a user adjustable programmed analysis method designed for formol number analysis. It employs a powerful and effective algorithm to analyze the pH response to determine the exact pH endpoint, then uses this algorithm to perform the necessary calculations.

This mini titrator is also designed to be used as a benchtop pH/mV meter. The CAL Check function not only ensures an accurate pH reading when the HI84533 is used as a pH meter but also an accurate titration since the endpoint is determined by a set pH value.

## Why Formol Number is an Important Determination

The content of amino-acids and other nitrogen compounds in fruit juices and wines is expressed as total assimilable nitrogen and is determined by the formol method using an acid-base titration. The formol number (also known as formol index) is a parameter used for evaluation of the quality of fruit juices and wines.

In wines, the concentration of alpha amino acid in grapes change as a function of maturity and crop load (yield to vine size ratio). The concentration increases with fruit

*The HI84533 has two operating options:*

1. pH measurement using the meter in pH mode
2. Formol number determination by titration of wines and fruit juice samples with sodium hydroxide solution to an 8.2 pH endpoint



maturation and decreases with crop load. In the fermentation of wine, there is a minimum amount of amino acid and other nitrogen compounds (eg: 150-200 mg/L of yeast assimilable nitrogen) that has to be present in the must/juice. Too low of an amount will result in a stuck fermentation in which there is not enough nitrogen for the yeast to thrive. Because of the importance of nitrogen in

fermentation, it is desirable to determine the nitrogen concentration before fermentation.

In fruit juices, the formol nitrogen number is one of the basic parameters measured to determine quality. Depending on the type of fruit, the number can increase or decrease with maturity. In orange and grapefruit juice, lower values are observed when the fruit is

not suitably mature or there has been frost damage. In pineapple juice, a low number could be indicative of over-dilution with water or a disproportionate amount of the core was used. To determine the adulteration of fruit juices, the formol number, along with the chromatography characterization of amino acids, can be used.

## On-screen Features

Last Electrode Calibration	
Date: 2012/05/31	8.20
Time: 05:13:04 PM	7.01
Cal Expire: 3 Days	4.01
Offset: 1.4mV	
Slope: 102.9%	
Electrode Condition: 100%	

### GLP

The GLP feature records electrode and pump calibration data to help keep measurements accurate and reliable.

Record number: 2	
2013/03/13	15:09:08
111.5mg/L	25.5°C
3781134.txt file	
Plot	Export

### Log and recall data

The HI84533 can log up to 400 samples (200 for titration results; 200 for mV/pH) and recall or export data to a USB drive or PC.

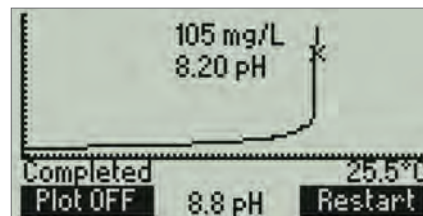

### Titration curve displayed on screen

The HI84533 offers real time graphing of the titration curve on the LCD.

## Specifications

### HI84533

Titrator	Range (as N)	Low Range: 2.14 to 28.57 meq/L; 0.21 to 2.85 meq%; 30.0 to 400.0 mg/L High Range: 21.7 to 71.4meq/L; 2.14 to 7.14 meq%; 300 to 1000 mg/L
	Resolution	Low Range: 0.01 meq/L; 0.01 meq%; 0.1 mg/L High Range: 0.1 meq/L; 0.01 meq%; 1 mg/L
	Accuracy (@25°C/77°F)	±0.1 mg/L or 3 % of reading, whichever is greater
	Sample Volume	Low Range: 10 mL High Range: 5 mL
	Method	acid-base titration
	Principle	endpoint titration, adjustable (pH 8.0 - 8.5 in 0.1 increments)
	Pump Speed	10 mL/min
pH Meter	Stirring Speed	600 rpm
	Range	-2.0 to 16.0 pH / -2.00 to 16.00 pH
	Resolution	0.1 pH / 0.01 pH
	Accuracy (@25°C/77°F)	±0.01 pH
	Calibration	one, two, or three-point calibration; 4 available buffers (4.01; 7.01; 8.20; 10.01)
mV Meter	Temperature Compensation	manual or automatic
	Range	-2000.0 to 2000.0 mV
	Resolution	0.1 mV
Temperature	Accuracy	±1.0 mV
	Range	-20.0 to 120.0°C; -4.0 to 248.0°F; 253.2 to 393.2 K
	Resolution	0.1°C; 0.1°F; 0.1 K
Additional Specifications	Accuracy	±0.4°C; ±0.8°F; ±0.4 K
	Logging Data	up to 400 samples (200 pH/mV, 200 titration)
	pH Electrode	HI131B glass body, refillable, with BNC connector and 1 m (3.3') cable (included)
	Temperature Probe	HI7662-T stainless steel temperature probe with 1 m (3.3') cable (included)
	Connectivity	(1) Type-B USB for PC interface, (1) Type-A USB for storage
	Environment	0 to 50°C (32 to 122°F); RH max 95% non-condensing
	Power Supply	12 VDC adapter (included)
Ordering Information	Dimensions	235 x 200 x 150 mm (9.2 x 7.9 x 5.9")
	Weight	1.9 kg (67.0 oz.)
	<p><b>HI84533-01</b> (115V) and <b>HI84533-02</b> (230V) are supplied with HI84533-70 reagent kit for formol number in wine and fruit juices, HI131B pH electrode, HI7662-T temperature probe, HI7082 electrode fill solution (30 mL), 100 mL beakers (2), tube set (aspiration tube with titrant bottle cap and dispensing tube with tip), dosing pump valve, 5 mL syringe (2), 2000 µL automatic pipette (1) with plastic tips (2), plastic pipette (1 mL), HI731319 stir bar, electrode cleaning solution sachets for wine deposits (2), electrode cleaning solution sachets for wine stains (2), power adapter, instruction manual and quality certificate.</p>	

HI84500

## Sulfur Dioxide Mini Titrator

for Wine Analysis

- Piston driven pump with dynamic dosing
  - For highly accurate, repeatable results
- Log-on-demand
  - Log data up to 400 samples (200 for titration; 200 for ORP/mV)
- Graphic mode/exportable data
  - Displays in-depth data on titration, which can then be stored and exported to either a USB drive or PC using the USB connection
- Automatic stirrer speed control
  - Maintains stirrer speed at 700 RPM regardless of viscosity of solution
- GLP features
  - Date, time, offset, slope and buffers used
- Easy-to-use interface
  - User intuitive design with large keys and easy to navigate screens
- HELP features
  - Dedicated HELP key for content sensitive help
- mV meter



### An Easy-to-Use, Fast and Affordable All-in-one Solution

The HI84500 is an easy to use, fast and affordable automatic mini titrator designed for testing free or total sulfur dioxide (SO<sub>2</sub>) levels in wine. It includes a pre-programmed analysis method and uses a powerful algorithm in order to determine when the titration reaction has reached completion. The HI84500 incorporates a precision dosing pump which allows for a highly accurate determination of the amount of titrant used. Pump calibrations, performed with the provided Hanna standards, help assure the measurement accuracy. The HI84500 also features a new low range measurement and can also be used as a mV meter for direct ORP measurements.

This new generation of mini automatic titrator improves upon the titrant delivery system and measuring ranges for increased accuracy compared to previous models. This meter reflects Hanna's years of experience as a manufacturer of analytical instruments.

### Why Free & Total Sulfur Dioxide is Important

Winemakers add sulfur dioxide to wine in order to inhibit bacteria and wild yeast growth and to serve as an antioxidant to prevent browning. When SO<sub>2</sub> is added to wine, a portion of it becomes immediately bound while a remaining portion is unbound SO<sub>2</sub>. The portion that is unbound is also called free SO<sub>2</sub>; it is responsible for protecting the wine.

The bound and free SO<sub>2</sub> together are referred to as total SO<sub>2</sub>. The relationship between the amount of SO<sub>2</sub> added and the amount of free SO<sub>2</sub> is complex. This relationship is governed by the total amount of SO<sub>2</sub> in the wine and the ability of compounds (e.g. sugars, aldehydes, ketonic acid, quinones, anthocyanin) in the wine to bind SO<sub>2</sub>.

The exact relationship between free and bound SO<sub>2</sub> will vary from wine to wine. The amount of free SO<sub>2</sub> depends on how much is added, how much was present before the addition, and how much was immediately

bound. Free SO<sub>2</sub> exists in two forms: bisulfite (HSO<sub>3</sub><sup>-</sup>) is the predominant form but is relatively ineffective and molecular SO<sub>2</sub> is the minor form and is responsible for protecting the wine. The amount of molecular SO<sub>2</sub> available in wine is depended on the amount of free SO<sub>2</sub> present and the pH. Typically 0.8 ppm of molecular SO<sub>2</sub> provides adequate protection against bacteria growth and oxidation. In order to obtain this value for a wine sample that has a pH of 3.2 you would need 22 ppm of free SO<sub>2</sub>; if the pH was at 3.5 you would need double the amount, 44 ppm of free SO<sub>2</sub>.

Molecular SO<sub>2</sub> can be detected by human senses at about 2.0 ppm. This level is needed for maximum protection of wine. Higher levels are needed for sweet and most notable, botrytised wine. The HI84500 can be used to test for free and total SO<sub>2</sub> in all wines, including red, which are difficult to test using traditional methods associated with a distinctive color change to determine the endpoint.

## Application-specific ORP Electrode

The HI84500 is supplied with the HI3148B ORP electrode featuring CPS™ technology to prevent the clogging of the reference junction. Conventional electrodes may clog quickly in biological samples such as wine. By design, the HI3148B ORP electrode utilizes a ground glass/PTFE sleeve junction which controls a steady, predictable flow of electrolyte solution, keeping the junction open. The hydrophobic properties of PTFE repels wetness and coatings.

## On-screen Features



### Titration curve displayed on screen

The HI84500 offers real time graphing of the titration curve on the LCD.

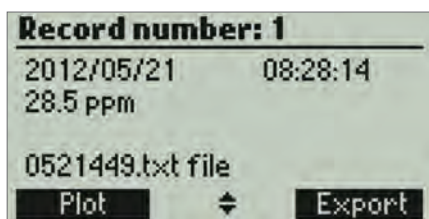

### Log and recall data

Log up to 400 samples (200 for titration results; 200 for ORP/mV) and recall or export data to a USB stick or PC.



### ORP

During ORP measurements, the stirrer icon will be displayed when the stirrer is on



### Procedure warnings

Users are warned if there is an error in procedures such as the titration exceeded the maximum volume of titrant.

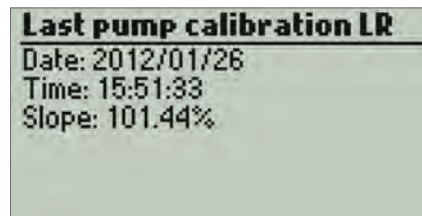

### GLP

Records pump calibration data to ensure measurements are accurate and reliable.

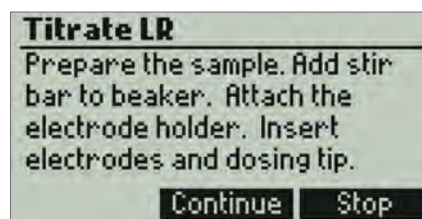

### Tutorial and help screens

Accessing the tutorial menu provides helpful information during calibration and titration.

## Specifications

Specifications		HI84500
Titrator	Range	Low Range: 1.0 to 40.0 ppm of SO <sub>2</sub> High Range: 30 to 400 ppm of SO <sub>2</sub>
	Resolution	Low Range: 0.1 ppm High Range: 1 ppm
	Accuracy (@25°C/77°F)	Low Range: ±0.5 ppm or 3% of reading, whichever is greater High Range: ±1 ppm or 3% of reading, whichever is greater
	Sample Volume	50 mL
	Method	Ripper method
	Principle	equivalence point redox titration
	Pump speed	10 mL/min
	Stirring Speed	700 rpm
ORP Meter	Range	-2000.0 to 2000.0 mV
	Resolution	0.1 mV
	Accuracy (@25°C/77°F)	±1 mV
Additional Specifications	Logging Data	up to 400 samples (200 ORP/mV, 200 titration)
	Electrode	HI3148B glass body ORP electrode with BNC connector and 1 m (3.3') cable (included)
	Connectivity	(1) Type-B USB for PC interface, (1) Type-A USB for storage
	Environment	0 to 50°C (32 to 122°F); RH max 95% non-condensing
	Power Supply	12 VDC adapter (included)
	Dimensions	235 x 200 x 150 mm (9.2 x 7.9 x 5.9")
	Weight	1.9 kg (67.0 oz.)
Ordering Information	<b>HI84500-01</b> (115V) and <b>HI84500-02</b> (230V) are supplied with HI3148B ORP electrode, HI7082 electrode fill solution (30 mL), HI84500-70 reagent kit for SO <sub>2</sub> determination (consisting of: 1 bottle HI84500-50 (230 mL) low range titrant, 1 bottle HI84500-51 high range titrant (230mL), 1 bottle HI84500-55 pump calibration standard (120 mL), 1 bottle HI84500-60 acid reagent (230 mL), 1 bottle HI84500-61 alkaline reagent (120 mL) and HI84500-62 stabilizer packets (100 packets)), 100 mL beakers (2), 20 mL beakers (2), scissors, dosing pump valve, 5 mL syringe, 1 mL plastic pipette, tube set (aspiration tube with titrant bottle cap and dispensing tube with tip), stir bar, electrode cleaning solution sachets for wine deposits (2), electrode cleaning solution sachets for wine stains (2), power adapter, instruction manual and quality certificate.	

HI84502

# Total Acidity Mini Titrator and pH Meter

for Wine Analysis

- **Piston driven pump with dynamic dosing**
  - For highly accurate, repeatable results
- **CAL Check™**
  - Alerts users to potential problems during calibration such as contaminated buffers or dirty/broken pH electrode
- **Log-on-demand**
  - Log data up to 400 samples (200 for titration; 200 for pH/mV)
- **Graphic mode/exportable data**
  - Displays in-depth data on titration, which can then be stored and exported to either a USB drive or PC using the USB connection
- **Automatic stirrer speed control**
  - Maintains stirrer speed at 600 RPM regardless of viscosity of solution
- **GLP features**
  - Date, time, offset, slope and buffers used
- **Easy-to-use interface**
  - User intuitive design with large keys and easy to navigate screens
- **Help features**
  - Dedicated HELP key for content sensitive help
- **pH/mV meter**
  - Doubles as a benchtop pH meter



## An Easy-to-Use, All-in-one Solution

The HI84502 is an easy to use, fast and affordable automatic mini titrator designed for testing total acidity levels in wine. It includes a pre-programmed analysis method and uses a powerful algorithm in order to determine when the titration reaction has reached completion. The results are displayed in g/L as tartaric acid. The HI84502 incorporates a precision piston driven dosing pump which allows for a highly accurate determination of the amount of titrant used. Pump calibrations performed with the provided Hanna standards assure the accuracy of measurements.

This mini titrator is also designed to be used as a benchtop pH/mV meter. As a pH meter, it has many features of a professional grade benchtop including automatic calibration up to three points with four available buffers, a 0.01 pH resolution, accuracy of  $\pm 0.01$  pH, automatic temperature compensation and comprehensive GLP data.

The GLP data includes date, time, offset, slope, and buffers used for calibration.

Accuracy is always ensured with Hanna's unique CAL Check feature, which analyzes the response of the electrode during the calibration process. Based on electrode response in the buffer, indicators are displayed on screen to alert the user of potential problems during calibration. These indicators include Buffer Contaminated, Electrode Dirty/Broken, and overall probe condition. The CAL Check function not only ensures an accurate pH reading when the HI84502 is used as a pH meter but also an accurate titration since the endpoint is determined by a set pH value.

## The Significance of Titratable Total Acidity

Acids occur naturally during the growing of grapes and as part of the fermentation process. Wines show lower levels of acid when there is a hot growing season or when the grapes come from warmer regions. In the proper proportion, acids are a desirable trait and give the wine character. The three predominant acids in wine are tartaric, malic and citric. Tartaric acid is the principal acid in grapes and is a component that promotes a crisp flavor and graceful aging in wine. A

moderate amount of a wine's acid comes from malic acid, which contributes to fruitiness. A small amount of titratable acidity comes from citric acid. Wine also contains trace amounts of other acids; the least desirable acid in wine is acetic acid, which, when present in more than a nominal amount, gives wine a sour or vinegary aspect.

Total acidity, also called titratable acidity, is the sum of the fixed and volatile acids. In the United States the total acidity is usually expressed in terms of tartaric acid, even though the other acids are measured.

Total acidity directly affects the color and flavor of wine and, depending on the style of the wine, is sought in a perfect balance with the sweet and bitter sensations of other components. Too much acidity makes wine tart and sharp; too little makes wines flat, flabby and uninteresting. Proper acidity in wine is what makes it refreshing and an ideal accompaniment to food. The proper acid level of a wine varies, with sweeter wines generally requiring somewhat higher levels to retain the proper balance.

## On-screen Features



### CAL Check™

A Hanna exclusive process for checking the condition of electrodes which helps keep measurements accurate.

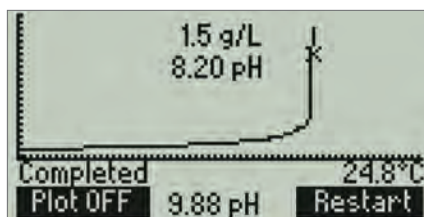

### Titration Curve Displayed On Screen

The HI84502 offers real time graphing of the titration curve on the LCD.

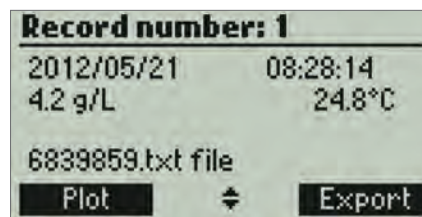

### Log and Recall Data

Log up to 400 samples (200 for titration results; 200 for mV/pH) and recall or export data to a USB stick or PC.

## Specifications

### HI84502

Titrator	Range	Low Range: 0.1 to 5.0 g/L (ppt) of tartaric acid High Range: 4.0 to 25.0 g/L (ppt) of tartaric acid
	Resolution	0.1 g/L (ppt)
	Accuracy (@25°C/77°F)	±0.1 g/L or 3 % of reading, whichever is greater
	Method	acid-base titration
	Sample Volume	Low Range: 10 mL High Range: 2 mL
	Principle	endpoint titration: 7.00 pH or 8.20 pH
	Pump speed	10 mL/min
	Stirring Speed	600 rpm
pH	Range	-2.0 to 16.0 pH; -2.00 to 16.00 pH
	Resolution	0.1 pH / 0.01 pH
	Accuracy (@25°C/77°F)	±0.01 pH
	Calibration	one, two or three-point calibration, four available buffers (4.01, 7.01, 8.20, 10.01)
mV Meter	Temperature Compensation	manual or automatic
	Range	-2000.0 to 2000.0 mV
	Resolution	0.1 mV
Temperature	Accuracy (@25°C/77°F)	±1.0 mV
	Range	-20.0 to 120.0°C; -4.0 to 248.0°F; 253.2 to 393.2 K
	Resolution	0.1°C; 0.1°F; 0.1 K
Additional Specifications	Accuracy (@25°C/77°F)	±0.4°C; ±0.8°F; ±0.4 K
	Logging Data	up to 400 samples ( 200 pH/mV, 200 titration)
	pH Electrode	HI1048B glass body pH electrode with BNC connector and 1 m (3.3') cable (included)
	Temperature Probe	HI7662-T stainless steel temperature probe with 1 m (3.3') cable (included)
	Connectivity	(1) Type-B USB for PC interface, (1) Type-A USB for storage
	Environment	0 to 50°C (32 to 122°F); RH max 95% non-condensing
	Power Supply	12 VDC adapter (included)
	Dimensions	235 x 200 x 150 mm (9.2 x 7.9 x 5.9")
Weight	1.9 kg (67.0 oz)	
Ordering Information	<b>HI84502-01</b> (115V) and <b>HI84502-02</b> (230V) are supplied with HI1048B pH electrode, HI7662-T temperature probe, HI7082 electrode fill Solution (30 mL), HI84502-70 reagent kit (consisting of: 1 bottle HI84502-50 (230 mL) titration solution and HI84502-55 (120 mL) pump calibration standard (1 bottle)), (2) 100 mL beakers, dosing pump valve, 2000 µL automatic pipette (1) with plastic tips (2), 5 mL syringe, 1 mL plastic pipette, tube set (aspiration tube with titrant bottle cap and dispensing tube with tip), stir bar, electrode cleaning solution sachets for wine deposits (2), electrode cleaning solution sachets for wine stains (2), power adapter, instruction manual and quality certificate.	

# 4 Titration Solutions and Reagents



HI70401	potassium hydrogen phthalate, 20 g
HI70402	tartaric acid, 20 g
HI70403	sodium thiosulfate pentahydrate, 20 g
HI70404	potassium iodide powder packets, 100 packets
HI70405	glucose/fructose, 20 g
HI70406	sodium chloride, 20 g
HI70407	potassium iodate, 20 g
HI70408	oxalic acid, 20 g
HI70409	potassium permanganate, 20 g
HI70422	silver nitrate (0.1 M), 1L
HI70423	sodium hydroxide solution (0.11 N), 1 L
HI70424	amino-propanol buffer, 25 mL
HI70425	sulfuric acid solution (16%), 500 mL
HI70426	glyoxal solution (40%), 100 mL
HI70427	nitric acid solution (1.5 M), 500 mL
HI70428	sodium hydroxide solution (0.25N), 1 L
HI70429	silver nitrate solution (0.05 M), 1L
HI70432	hydrogen peroxide solution (3%), 25 mL
HI70433	stabilized iodine solution (0.01 N), 1L
HI70434	phosphoric acid (85%), 500 mL
HI70435	sodium hydroxide solution (5 M), 500 mL
HI70436	deionized water, 1 G
HI70437	potassium iodide concentrated (30%) solution, 500 mL
HI70438	tris buffer set, 1 L
HI70439	sodium thiosulfate solution (0.1 M), 1 L
HI70440	iodine stabilized solution (0.02 N), 1 L

HI70441	iodine stabilized solution (0.04 N), 1 L
HI70443	sulfuric acid solution (10%), 500 mL
HI70444	sulfuric acid solution (25%), 500 mL
HI70445	nitric acid solution (1 M), 500 mL
HI70446	Fehling solution A, 500 mL
HI70447	Fehling solution B, 500 mL
HI70448	silver nitrate solution (0.02 M), 1 L
HI70449	EDTA solution (0.02 M), 1 L
HI70453	hydrochloric acid solution (0.02 N), 1 L
HI70454	sodium hydroxide solution (0.02 N), 1 L
HI70455	sodium hydroxide solution (0.01 N), 1 L
HI70456	sodium hydroxide solution (0.1 N), 1 L
HI70457	sodium hydroxide solution (1 N), 1 L
HI70458	sulfuric acid solution (0.01 M), 1 L
HI70459	sulfuric acid solution (0.05 M), 1 L
HI70462	hydrochloric acid solution (0.01 N), 1 L
HI70463	hydrochloric acid solution (0.1 N), 1 L
HI70464	hydrochloric acid solution (1 N), 1 L
HI70465	hydrogen peroxide solution (30%), 25 mL
HI70466	phenylarsine oxide (PAO) solution (0.00564N), 500 mL
HI70467	pH 4.18 acetate buffer, 250 mL
HI70468	potassium iodide, 35g
HI70469	iodine solution (0.00188N), 230 mL (4)
HI70471	phenylarsine oxide (PAO) solution (0.000564N), 500 mL
HI70472	pH 7.15 phosphate buffer solution, 250 mL
HI70436M	distilled water, 250 ml

# Meter Accessories and Reagents



## HI932 and HI931 Automatic Titration System Accessories

Code	Description
HI930100	dosing pump
HI930101	dosing pump with peristaltic pump (HI932 only)
HI930150	50 mL burette assembly (includes syringe, aspiration, and dispensing tubes)
HI930125	25 mL burette assembly (includes syringe, aspiration, and dispensing tubes)
HI930110	10 mL burette assembly (includes syringe, aspiration, and dispensing tubes)
HI930105	5 mL burette assembly (includes syringe, aspiration, and dispensing tubes)
HI900250	50 mL burette syringe
HI900225	25 mL burette syringe
HI900210	10 mL burette syringe
HI900205	5 mL burette syringe
HI900260	3-way valve (includes 3 gaskets and 2 screws)
HI900942	tool for burette cap removal
HI900270S	aspiration tube set with 316 stainless steel fitting (includes blue protection tube, gasket, and tube lock)
HI930280	dispensing tube set with 316 stainless steel fitting (includes standard dispensing tip, blue protection tube, gasket, and tube lock)
HI930190	blank burette holder
HI930191	blank cover
HI930201	Replacement cap and rotor for peristaltic pump
HI930202	tubing set with plastic dispensing tube for peristaltic pump
HI930204	roller tube for peristaltic pump (3)
HI930301	overhead stirrer (includes overhead stirrer and 3 propellers)
HI930302	replacement propellers (3)
HI930303	PVDF replacement propellers (3) for organic solvents
HI930310	overhead electrode holder (includes overhead holder without electronics or propeller)
HI930311	electrode adapter for overhead stirrer holder
HI930320	stirrer support (metal rod only)
HI930330	titrant bottle cap assembly
HI7662-TW	temperature probe
HI920013	USB cable (1.8 m)
HI930900U	USB storage device with HI900 PC software
HI930401	potentiometric analog board for HI932
HI900945	shorting cap
HI900946	power adapter 110VAC to 24VDC
HI900947	power adapter 220VAC to 24VDC
HI930800	instruction manual for HI931
HI930801	instruction manual for HI932C1 and HI932C2
HI930805	HI932 Design, Installation, Operation, and Performance Qualification (DQ/IQ/OQ/PQ) Documentation

HI930100

HI930101  
(HI932 only)

burette



HI930310



HI930301



HI930320





### HI922 Autosampler Accessories

Code	Description
HI920-922	control panel for HI922
HI7662-AW	autosampler temperature sensor w/1.5m cable
HI920-933	titrator/autosampler communication cable
HI920-960	tray locking screw
HI920-931	BNC extension cable (1m)
HI920-932	reference extension cable (1m)
HI920-310	electrode holder
HI920-901	USB storage device
HI920-281	titrant dispensing tube (1.5 m)
HI920-103	peristaltic pump with dispensing tubing
HI920-104	peristaltic pump with aspiration tubing
HI920-113	membrane pump with tubing
HI920-11660W	16 Beaker Tray, 60 mm diameter, Single Row with RFID
HI920-11853W	18 Beaker Tray, 53 mm diameter, Single Row with RFID
HI920-060	120 mL plastic beakers that fit HI920-11660W (20)
HI920-053	100 mL plastic beakers that fit HI920-11853W (20)
HI920-290	Tygon tube (5 m)
HI930301	overhead stirrer
HI920-201	replacement Cap and Rotor for peristaltic pump
HI920-208	dispensing set with plastic dispensing tube for peristaltic pump
HI920-203	dispensing set with stainless steel aspiration tube for peristaltic pump
HI920-204	roller tube for peristaltic pump (3)
HI920-205	roller tube for peristaltic pump - high chemical compatibility (3)
HI930302	replacement propellers (3)
HI930303	replacement propellers - high chemical resistance (3)
HI920-320	cable chain
HI920-191	pump covers
HI731319	25 mm x 7 mm stir bars (10)



HI920-922





## HI933 KF Volumetric Titrator Accessories

Code	Description
HI76320	dual platinum pin KF electrode with BNC connector
HI900205	5 mL syringe
HI900522	beaker for HI903/HI933
HI900523	dispensing tip (2)
HI900527	septum (5)
HI900528	solvent port plugs (2)
HI900530	titrant bottle top assembly
HI900531	solvent/waste bottle top assembly
HI900532	desiccant cartridge for titration beaker or titrant bottle
HI900533	desiccant cartridge for solvent or waste bottle
HI900534	waste bottle
HI900535	tubing for solvent/waste handling (2)
HI900536	tubing for air pump (2)
HI900540	O-ring set
HI900550	desiccant, 250 g
HI900570S	aspiration tubing
HI900580S	dispensing tubing and fitting
HI900941	calibration key
HI900942	tool for burette cap removal
HI920013	USB cable
HI930100	pump assembly
HI930180	air pump and magnetic stirrer for HI933/HI934
HI930505	5 mL burette assembly
HI930520	beaker assembly
HI930521	beaker locker ring
HI930525	beaker holder
HI930900U	USB flash drive
HI930803	instruction manual binder for HI933
HI930806	HI933 Design, Installation, Operation, and Performance Qualification (DQ/IQ/OQ/PQ) Documentation

## HI934 KF Coulometric Titrator Accessories

Code	Description
HI76330	detector electrode
HI900511	generator electrode with diaphragm
HI900512	generator electrode without diaphragm
HI900534	waste bottle
HI900535	tubing for solvent/waste handling (2)
HI900536	tubing for air pump (2)
HI900537	bottle top assembly (with molecular sieves)
HI900538	desiccant cartridge for reagent/waste bottles
HI900542	O-ring set
HI900543	glass joint grease
HI900551	molecular sieves, 150 g
HI900561	titration vessel (glass only)
HI900563	glass stopper, standard taper 19
HI900564	desiccant cartridge for generator electrodes
HI900566	open-top GL18 cap
HI900567	septum (5)
HI900568	reagent exchange adapter
HI900931	generator cable
HI900940	calibration key
HI920013	USB cable
HI930180	air pump and magnetic stirrer for HI933/HI934
HI930182	reagent adapter holder
HI930560	titrator vessel assembly
HI930939	generator calibration cable
HI930900U	USB flash drive
HI930804	instruction manual binder for HI934
HI930807	HI934 Design, Installation, Operation, and Performance Qualification (DQ/IQ/OQ/PQ) Documentation



## HI921 Autosampler Accessories

Code	Description
HI920-11660	single row with RFID, 16 beaker position, 60mm dia.
HI920-060	120 mL plastic beakers that fit HI920-11660 (20)
HI920-11853	single row with RFID, 18 beaker position, 53mm dia.
HI920-053	100 mL plastic beakers that fit HI920-11853 (20)
HI920-301	overhead stirrer
HI920-101	peristaltic pump with dispensing tubing
HI920-102	peristaltic pump with aspiration tubing
HI920-111	membrane pump for rinsing probes
HI920-112	electrode holder accessory for HI920-111 membrane pump
HI920-201	peristaltic pump replacement cap and rotor
HI920-202	peristaltic pump complete tubing set with plastic dispensing tube
HI920-203	peristaltic pump complete tubing set with stainless-steel aspiration tube
HI920-205	peristaltic pump roller tube (3) with fittings and grease - general purpose
HI920-204	peristaltic pump roller tube (3) with fittings and grease - increased chemical resistance
HI920-206	Tygon E-LFL tubing set for peristaltic pump, inlet and outlet with increased chemical resistance
HI920-207	Tygon E-LFL tubing set with SS aspiration tube for peristaltic pump, inlet and outlet with increased chemical resistance
HI920-290	5m Tygon tube
HI920-280S	1.5m dispensing tube set with 316 stainless steel fitting for burette to autosampler
HI920-304	Replacement shearing type polycarbonate propeller (1) for HI921 overhead stirrer
HI920-302	replacement propellers (3)
HI920-303	high chemical resistance replacement propellers (3)
HI920-310	three electrode holder
HI920-900	USB memory stick
HI920-921	control panel for HI921
HI920-930	titrator/autosampler communication cable
HI920-931	BNC extension cable (1m)
HI920-932	reference extension cable (1m)
HI920-960	tray locking screw
HI7662-A	autosampler temperature sensor w/1.5m cable
HI731319	25 mm x 7 mm stir bars (10)

## HI84534 Titratable Acidity Mini Titrator and pH Meter Reagents and Accessories

Reagent Code	Description
HI84534-50	Titratable acidity titrant, 120 mL
HI84534-55	Titratable acidity calibration standard, 120 mL
HI7004M	pH 4.01 buffer, 230 mL
HI7007M	pH 7.01 buffer, 230 mL
HI70082M	pH 8.20 buffer, 230 mL
HI7010M	pH 10.01 buffer, 230 mL
HI70300M	storage solution, 230 mL
HI7082	pH electrode filling solution, 3.5M KCl, 30 mL (4)
HI7061M	general purpose electrode cleaning solution, 230 mL

Accessory Code	Description
HI70500	tube set with cap for titrant bottle, tip and valve
HI731319	stir bar, 25 x 7 mm (10)
HI740036P	100 mL beaker (10)
HI740236	5 mL syringe for mini titrator
HI920013	PC connection cable
HI1131B	replacement pH electrode
HI7662-T	replacement temperature probe
HI7100051/8	115 Vac to 12 Vdc, 800 mA
HI7100061/8	230 Vac to 12 Vdc, 800 mA

## HI84530 Total Titratable Acidity Mini Titrator and pH Meter Reagents and Accessories

Reagent Code	Description
HI84530-50	titrant solution for low range, 120 mL
HI84530-51	titrant solution for high range, 120 mL
HI84530-55	pump calibration standard, 230 mL
HI84530-60	hydrogen peroxide, 30 mL
HI7004M	pH 4.01 buffer, 230 mL
HI7007M	pH 7.01 buffer, 230 mL
HI70083M	pH 8.30 buffer, 230 mL
HI7010M	pH 10.01 buffer, 230 mL
HI70300M	storage solution, 230 mL
HI7082	pH electrode filling solution, 3.5M KCl, 30 mL (4)
HI7061M	general purpose electrode cleaning solution, 230 mL

Accessory Code	Description
HI70500	tube set with cap for titrant bottle, tip and valve
HI731319	stir bar, 25 x 7 mm (10)
HI740036P	100 mL beaker (10)
HI740236	5 mL syringe for mini titrator
HI920013	PC connection cable
HI1131B	replacement pH electrode
HI7662-T	replacement temperature probe
HI7100051/8	115 Vac to 12 Vdc, 800 mA
HI7100061/8	230 Vac to 12 Vdc, 800 mA



HI84531 Titration Alkalinity Mini Titrator and pH Meter Reagents and Accessories

Reagent Code	Description
HI84531-50	titrant solution for low range, 120 mL
HI84531-51	titrant solution for high range, 120 mL
HI84531-55	pump calibration standard, 230 mL
HI7004M	pH 4.01 buffer, 230 mL
HI7007M	pH 7.01 buffer, 230 mL
HI70083M	pH 8.30 buffer, 230 mL
HI7010M	pH 10.01 buffer, 230 mL
HI70300M	storage solution, 230 mL
HI7082	pH electrode filling solution, 3.5M KCl, 30 mL (4)
HI7061M	general purpose electrode cleaning solution, 230 mL
Accessory Code	Description
HI740236	5 mL syringe for mini titrator
HI70500	tube set with cap for titrant bottle, tip and valve
HI731319	stir bar, 25 x 7 mm (10)
HI740036P	100 mL beaker (10)
HI920013	PC connection cable
HI1131B	replacement pH electrode
HI7662-T	replacement temperature probe
HI7100051/8	115 Vac to 12 Vdc, 800 mA
HI7100061/8	230 Vac to 12 Vdc, 800 mA

HI84529 Titration Acidity Mini Titrator and pH Meter Reagents and Accessories

Reagent Code	Description
HI84529-50	titrant solution for low range 20, 120 mL
HI84529-51	titrant solution for high range 20, 120 mL
HI84529-52	titrant solution for low range 50, 120 mL
HI84529-55	pump calibration standard, 230 mL
HI7004M	pH 4.01 buffer, 230 mL
HI70060M	pH 6.00 buffer, 230 mL
HI70083M	pH 8.30 buffer, 230 mL
HI7010M	pH 10.01 buffer, 230 mL
HI70300M	storage solution, 230 mL
HI70640M	cleaning solution for milk deposits, 230 mL
HI70641M	cleaning and disinfection solution for dairy products, 230 mL
HI7072	reference half-cell filling solution, 1M KNO <sub>3</sub> , 30 mL (4)
Accessory Code	Description
HI70500	tube set with cap for titrant bottle, tip and valve
HI731319	stir bar, 25 x 7 mm (10)
HI740036P	100 mL beaker (10)
HI740037P	20 mL beaker (10)
HI740236	5 mL syringe for mini titrator
HI920013	PC connection cable
FC260B	replacement pH half-cell electrode for dairy
HI5315	replacement reference half-cell electrode
HI7662-T	replacement temperature probe
HI7100051/8	115 Vac to 12 Vdc, 800 mA
HI7100061/8	230 Vac to 12 Vdc, 800 mA

HI84532 Titration Acidity Mini Titrator and pH Meter Reagents and Accessories

Reagent Code	Description
HI84532-50	titrant solution for low range, 120 mL
HI84532-51	titrant solution for high range, 120 mL
HI84532-55	pump calibration standard, 230 mL
HI7004M	pH 4.01 buffer, 230 mL
HI7007M	pH 7.01 buffer, 230 mL
HI70082M	pH 8.20 buffer, 230 mL
HI7010M	pH 10.01 buffer, 230 mL
HI70300M	storage solution, 230 mL
HI7061M	general purpose cleaning solution, 230 mL
HI7082	pH electrode filling solution, 3.5M KCl, 30 mL (4)
Accessory Code	Description
HI731342	automatic pipette (2000 µL)
HI731352	tips for 2000 µL automatic pipette (4)
HI70500	tube set with cap for titrant bottle, tip and valve
HI731319	stir bar, 25 x 7 mm (10)
HI740036P	100 mL beaker (10)
HI740037P	20 mL beaker (10)
HI740236	5 mL syringe for mini titrator
HI920013	PC connection cable
HI1131B	replacement pH electrode
HI7662-T	replacement temperature probe
HI7100051/8	115 Vac to 12 Vdc, 800 mA
HI7100061/8	230 Vac to 12 Vdc, 800 mA



**HI84533 Formol Number Mini Titrator and pH Meter Reagents and Accessories**

Reagent Code	Description
HI84533-50	titrant solution, 230 mL
HI84533-55	pump calibration standard, 120 mL
HI84533-60	hydrogen peroxide reagent, 30 mL
HI84533-61	formol base reagent, 230 mL
HI84533-62	pH adjustment reagent, 30 mL
HI7004M	pH 4.01 buffer, 230 mL
HI7007M	pH 7.01 buffer, 230 mL
HI70082M	pH 8.20 buffer, 230 mL
HI7010M	pH 10.01 buffer, 230 mL
HI70300M	storage solution, 230 mL
HI70635M	cleaning solution for wine deposits, 230 mL
HI70636M	cleaning solution for wine stains, 230 mL
HI7082	pH electrode filling solution, 3.5M KCl, 30 mL (4)
Accessory Code	Description
HI70500	tube set with cap for titrant bottle, tip and valve
HI731319	stir bar, 25 x 7 mm (10)
HI740036P	100 mL beaker (10)
HI740236	5 mL syringe for mini titrator
HI920013	PC connection cable
HI1131B	replacement pH electrode
HI7662-T	replacement temperature probe
HI7100051/8	115 Vac to 12 Vdc, 800 mA
HI7100061/8	230 Vac to 12 Vdc, 800 mA



**HI84500 Sulfur Dioxide Mini Titrator for Wine Analysis Reagents and Accessories**

Reagent Code	Description
HI84500-50	titrant solution for low range, 230 mL
HI84500-51	titrant solution for high range, 230 mL
HI84500-55	pump calibration standard, 120 mL
HI84500-60	acid reagent, 230 mL
HI84500-61	alkaline reagent (Total SO <sub>2</sub> ), 120 mL
HI84500-62	stabilizer powder packets (100)
HI7082	pH electrode filling solution, 3.5M KCl, 30 mL (4)
HI7021M	ORP test solution @ 240 mV (@25°C), 230 mL
HI7092M	oxidizing pretreatment solution, 230 mL
HI70635M	cleaning solution for wine deposits, 230 mL
HI70636M	cleaning solution for wine stains, 230 mL
HI70300M	storage solution, 230 mL
Accessory Code	Description
HI70500	tube set with cap for titrant bottle, dosing tip and valve
HI731319	stir bar, 25 x 7 mm (10)
HI740036P	100 mL beaker (10)
HI740037P	20 mL beaker (10)
HI740236	5 mL syringe for mini titrator
HI920013	PC connection cable
HI3148B	ORP electrode for wine
HI7100051/8	115 Vac to 12 Vdc, 800 mA
HI7100061/8	230 Vac to 12 Vdc, 800 mA



**HI84502 Total Acidity Mini Titrator and pH Meter for Wine Analysis Reagents and Accessories**

Reagent Code	Description
HI84502-50	titrant solution, 230 mL
HI84502-55	pump calibration standard, 120 mL
HI7004M	pH 4.01 buffer, 230 mL
HI7007M	pH 7.01 buffer, 230 mL
HI70082M	pH 8.20 buffer, 230 mL
HI7010M	pH 10.01 buffer, 230 mL
HI70300M	storage solution, 230 mL
HI70635M	cleaning solution for wine deposits, 230 mL
HI70636M	cleaning solution for wine stains, 230 mL
HI7082	pH electrode filling solution, 3.5M KCl, 30 mL (4)
Accessory Code	Description
HI70500	tube set with cap for titrant bottle, tip and valve
HI731352	tips for 2000 µL automatic pipette (4)
HI731342	automatic pipette 2000 µL
HI731319	stir bar, 25 x 7 mm (10)
HI740036P	100 mL beaker (10)
HI740236	5 mL syringe for mini titrator
HI920013	PC connection cable
HI1048B	replacement pH electrode for wine
HI7662-T	replacement temperature probe
HI7100051/8	115 Vac to 12 Vdc, 800 mA
HI7100061/8	230 Vac to 12 Vdc, 800 mA



<b>Introduction.....</b>	<b>5.2</b>	<b>Portable.....</b>	<b>5.26</b>
Product Spotlights .....	5.4	Ultrapure Water .....	5.26
Comparison Guides.....	5.5	Ultrapure Water and Water for Injection.....	5.29
<b>edge® .....</b>	<b>5.18</b>	<b>Solutions.....</b>	<b>5.36</b>
edge.....	5.18	Conductivity (EC).....	5.36
edge EC.....	5.22	TDS.....	5.41
<b>Benchtop .....</b>	<b>5.6</b>	Salinity.....	5.42
		Quick Cal.....	5.42

## Definition of Conductivity

Electrolytic conductivity, abbreviated as EC, is a measurement made in which electrical charges on atomic or larger sized particles in a medium are moved under the influence of a potential difference. EC is a measure of concentration however it is non-specific for ion type. An ion is a charged particle present in the solution that contributes to the current flow. Ions are formed when a salt such as sodium chloride is dissolved in water to form particles having electrical charges. Sodium chloride for example, separates into  $\text{Na}^+$  and  $\text{Cl}^-$ . This is a simplified definition for the measurement is affected by many things such as the type of ionic compound(s) dissolved in the water; the ions mobility, the solution viscosity, temperature as well as concentration.

Electrical conductance, the ability of a substance to conduct an electrical current is the reciprocal of electrical resistance. "Conductance" and "resistance" depend on the geometrical dimensions of the substance being measured. Conductivity and resistivity are "normalized" terms that are used to denote a bulk intrinsic property of a substance. This is the measurement a standardized EC probe on a conductivity or resistivity meter provides. Conductivity measurements can be used to provide additional industry specific measurements; TDS, Salinity and USP compliant conductivity. Many of Hanna's meters provide these measurements also.

## Units of Measurement

Electrical Resistivity  $\rho$  (Greek rho), also called Specific Resistance (1cm cube) uses units of Ohm.cm. For example, ultrapure water is said to have a value of 18.16 Mohm.cm.at 25°C.

Electrical Conductivity  $\sigma$  (Greek sigma and other symbols used also, is the reciprocal of resistivity and uses units of Siemens/cm (S/cm, mS/cm,  $\mu\text{S}/\text{cm}$ , dS/m). For example, ultrapure water is said to have a conductivity of: .055 $\mu\text{S}/\text{cm}$  at 25°C.

The IUPAC convension

1000 microSiemens/cm ( $\mu\text{S}/\text{cm}$ ) = 1.0 milliSiemen/cm (mS/cm).

Note: Prior to 1971 mho/cm was the unit used for conductivity. This unit can still be found in some older literature.

## Conductivity versus Resistivity

Although conductivity and resistivity are reciprocal units that may be converted easily, convention uses resistivity for very low electrolyte concentrations or trace contaminants i.e. ultrapure water, and conductivity for expressing meaningful salt levels i.e. seawater; electroplating baths, acid concentrations. Electrode style and measurement techniques also contribute to success in making conductivity or resistivity measurements reliably. Conductivity measurements can be used to provide useful industry specific measurements such as TDS, Salinity and USP compliant conductivity and many of Hanna's conductivity meters provide the computing power to provide these measurements automatically.

## TDS

TDS (total dissolved solids), is a method used to determine solid content in a solution. To determine TDS, the solution whose volume is known is evaporated and the residue weighed. A conductivity measurement is commonly used to estimate TDS (Total Dissolved Solids) based on the assumption the solids are predominately ionic in nature and the relationship between the dissolved ions and conductivity is known. TDS uses units of mg/L (ppm), or g/L. On some meters the user can input the TDS factor for the conversion. On more basic units the factor is automatically set to 0.50 A typical

TDS factor for strong ionic solutions is 0.5, while for weak ionic solutions (e.g. fertilizers) is 0.7.

$\text{TDS} = \text{factor} \times \text{EC}_{25}$

For example: 100 $\mu\text{S}/\text{cm}$  conductivity is a TDS of 50ppm when the factor is 0.5.

## Conductivity/Resistivity/TDS of Commonly Measured Substances

Sample at 25°C	M $\Omega$ •cm	$\mu\text{S}/\text{cm}$	mS/cm	TDS
Ultrapure Water	18.16	.055		
Power Plant Boiler Water	1.0	1.0		0.5 ppm
Drinking Water		500-800	0.5 to 0.8	250 to 400 ppm
Ocean Water		53000	53.0	9.24 g/L
1M NaCl		85000	85.0	42.5 g/L
5% NaOH		223000	223	
50% NaOH		150000	150	
1M HCl		332000	332	
10% HCl		700000	700	
32% HCl		700000	700	
31% HNO <sub>3</sub>		865000	865	

## Salinity

Conductivity measurements can be used for determining salinity as it relates to general oceanographic

use. Three measurement scales are in use and depending on the sophistication of the meter, are available for salinity measurement in Seawater. The 3 scales are Practical Salinity Scale (PSU); 1978, Percent Scale (%);and Natural Seawater Scale(g/L); 1966.

Practical salinity and the Natural Seawater require a conductivity calibration. The meters have the algorithms to convert the measurement to the desired scale. NaCl % requires a calibration in HI70371 standard. Portable meters with this measurement make it easy to measure salinity in salt water aquariums and brackish waters.

## Conductivity and Temperature

Conductivity changes with ion concentration and with temperature. For example, a standard potassium chloride solution used for calibration of a cell constant and conductivity bridge, changes conductivity as tabulated at right.

Having two variables changing would make it near impossible to take useful conductivity measurements. If the temperature was held constant, the conductivity measurement would only have the variable of ion concentration. Absolute conductivity is a conductivity measurement without temperature compensation. If the conductivity change with temperature change of a solution is a known characteristic, the Conductivity measurements can be corrected to a reference temperature (typically 20 or 25°C) by carefully measuring the solution temperature. Fortunately, Hanna EC sensors incorporate an integral temperature sensor to measure solution temperature. Compensation corrects the measured conductivity to a reference temperature by applying a fixed factor  $\beta$  for linear compensation. High end meters allow adjustment of  $\beta$  to compensate for various solutions and permit adjustment of a reference temperature over a wider range of temperatures.  $\beta$  for neutral salts is typically between 1.5 to 2.2%/°C.

Conductivity 0.01m KCl	
°C	uS/cm
21	1305
22	1332
23	1359
24	1386
25	1413
26	1441
27	1468
28	1496

$$EC_{25} = \frac{EC_x}{(1 + \beta_{25}(T_x - 25))}$$

## Typical Temperature Coefficients of Various Solutions

Sample	Percent / °C	Sample	Percent / °C
Ultrapure Water	4.55	10% HCl	1.32
NaCl	2.12	5% H <sub>2</sub> SO <sub>4</sub>	0.96
5% NaOH	1.72	98% H <sub>2</sub> SO <sub>4</sub>	2.84

Non-linear temperature compensation for Natural waters is found some high end bench meters.

## (USP) United States Pharmacopeia Compliant Conductivity

Conductivity measurements are used for the preparation of pharmaceutical water for injection (WFI) worldwide. Hanna EC probes and meters can permit you to meet USP <645> Water Conductivity Requirements and European Pharmacopoeia 2.2.38 Conductivity Test for USP & EP Purified Water and Water for Injection. USP <645> with three stage compliance uses conductivity as a basis of ionic contaminants. Factors such as accuracy, resolution, cell constant certainty and ability to measure absolute conductivity are required. Stage 1 uses in-line conductivity measurements for compliance and a temperature/conductivity limit for compliance. Water that does not pass the Stage 1 limits must then be tested to Stage 2 requirements. This is a laboratory based technique that is streamlined using our meters with USP application firmware. They offer programmable set points to exceed the minimum meet USP and EP requirements and

prompts to guide the technician. Water that does not pass at Stage 2 must be tested for pH.

Using Hanna conductivity will help to meet the goals of the USP Purified Water and WFI requirements that include improved water quality, improved equipment reliability and reduction in the number of required tests.

## Conductivity Calibration

Conductivity standards are salt solutions for which the conductivity and temperature dependence are known. A well-defined relationship between Potassium Chloride concentration and electrolytic conductivity exists so KCl solutions are typically used as standards. A standard is used to determine the cell constant, in theory a defined geometric constant volume. Standards of 84  $\mu$ S/cm, 1413  $\mu$ S/cm, 5.00 mS/cm, or 12.88 mS/cm, 80 mS/cm and 111.8 mS/cm are manufactured by Hanna. Calibration is conducted with a value close to the samples conductivity. If the exact cell constant is known, some meters permit the manual input of the factor. This ensures maximum flexibility and measurement accuracy. Our research grade bench meters allow several points values to be calibrated for improved accuracy over a wider measurement range.

## Types of Conductivity

Three types of conductivity probes are manufactured by Hanna, The simplest design is a 2-Electrode Probe that utilizes an amperometric approach to make the measurement; a known AC voltage is applied at a specific frequency between a pair of electrodes in solution. The current produced is measured and reported in conductivity units referenced to a calibrated standard. Electrodes are made of graphite or metal. Fouling due to mineral deposits and polarization at high concentrations are drawbacks of this technology. Two electrode probes are best used in clean water applications when conductivities remain less than 5 mS/cm.

Four electrode conductivity (four-ring conductivity) utilizes a potentiometric approach to make the measurement; an alternating current is applied to the outer two "drive" electrodes to induce a current in the solution. The voltage is measured between the inner pair of electrodes in solution. The voltage is proportional the conductivity. This technology extends the linear range of measurement over three decades. Electrodes are made of graphite, stainless steel or Platinum. Polarization effects are reduced.

Both two and four electrode probes may incorporate a outer sleeve over the cell channel. The sleeve must stay in place during the measurement as this defines the volume of solution measured and the cell factor of the probe.

The third type of conductivity probe manufactured by Hanna is often found in industrial processes connected to a controller. An Inductive, Electrodeless or Toroidal conductivity probe uses two or more toroidal transformers which are inductively coupled side by side and encased in an inert plastic sheath. By applying a high frequency voltage to the drive toroid, a magnetic field develops that induces a current in the surrounding solution. A receiver toroid on the other side of the sensor measures the strength of the induced current. The strength depends on the conductivity of the solution. The benefits of this technology are no polarization effects, choice of material encapsulation can produce chemical resistant and relative immunity to fouling, and solutions are not needed for calibration.



HI6321

## Advanced Conductivity Meter

Conductivity/Resistivity/TDS/Salinity/Temperature

See page 5.6



HI98192

## Professional Waterproof Meters

EC/TDS/Resistivity/Salinity Meter with USP <645>

See page 5.26



HI2003

## edge® EC

Innovation in a single parameter

See page 5.22



HI98197

## Professional Waterproof Meter

for Ultrapure Water

See page 5.29



## Benchtop Meters

	EC Range	pH Range	ISE Range	DO Range	Resistivity Range	ORP Range	TDS Range	Salinity Range	Temperature Range(s)	EC Calibration Points	EC Calibration Solutions	ATC (Automatic Temperature Compensation)	Logging	GLP	Capacitive Touch Buttons	User Accounts	Touchscreen Interface	Wireless Connectivity	USB	PC Connectivity	Fully Customizable	Advanced Customization	Auto End Feature	AutoRanging	Benchtop, Portable & Wall-Mount	Page
HI6321	•				•		•	•	•	multi	6	•	•	•	•	•	•	•	A, C	•	•	•	•	•	•	5.6
HI5321	•				•		•	•	°C/°FK	4	†	•	•	•	•				device	•	•		•	•	•	5.16
edge®	•	•*		•*			•	•	°C/°F	1	6	•	•	•	•				A, micro	•				•	•	5.18
edge EC	•						•	•	°C/°F	1	6	•	•	•	•				A, micro	•				•	•	5.22

† auto standard recognition, custom calibration solution  
 \* Using compatible pH or DO probes respectively

## Portable Meters

	EC Range	pH Range	Resistivity Range	ORP Range	TDS Range	Salinity Range	Temperature Range(s)	EC Calibration Points	EC Calibration Solutions	ATC (Automatic Temperature Compensation)	BEPS	Logging	GLP	HOLD Feature	PC Connectivity	AutoRanging	AutoEnd	Waterproof	Flow Cell for WFI Applications	Page
HI98192	•		•		•	•	°C	5	7	•	•	•	•		•	•	•	•		5.26
HI98197	•		•		•	•	°C	5	7	•	•	•	•		•	•	•	•	•	5.29
HI99300	•				•		°C/°F	1	1	•	•			•				•		5.33
HI99301	•				•		°C/°F	1	1	•	•			•				•		5.33
HI8733	•							1		•								•		5.34
HI8734					•													•		5.35

# Advanced Conductivity Meter

Conductivity/Resistivity/TDS/Salinity/  
Temperature



HI6321 is a streamlined benchtop meter with a large touch screen display, comprised of a housing and an integrated conductivity measurement module.

Compact and easy to operate, the HI6321 includes Hanna's HI7631233 four-ring conductivity/resistivity/TDS/salinity probe.

Recommended for a wide range of industrial process water applications, HI7631233 provides stable measurements over a wide measurement range and does not require frequent calibrations. An integral temperature sensor measures the process temperature and adjusts the measured conductivity to a reference temperature by applying specialized compensation algorithms:

- Linear: appropriate when it is assumed that the temperature coefficient of variation has the same value for all measurement temperatures.
- Standard: appropriate for high-purity water measurements and documented in ASTM Standard D5391-14. This setting should be used for >1Mohm.cm resistivity measurements.
- Natural: appropriate for natural ground, well, or surface water (or water with similar composition) in accordance with ISO7888 standard.

The result is reliable electrolytic conductivity (EC), TDS (Total Dissolved Solids), resistivity, or Seawater Salinity in percent, psu, or ppt units.

TDS is a calculated value based on the conductivity of the solution ( $TDS = \text{factor} \times EC_{25}$ ). A TDS factor is a conversion factor used to change an EC measurement to a ppm measurement.

Sal psu: The practical salinity of seawater relates the ratio of electrical conductivity of a normal seawater sample at 15 °C and 1 atmosphere to a potassium chloride solution (KCl) with a mass of 32.4356 g/Kg water at the same temperature and pressure. Under these conditions the ratio is equal to 1 and  $S=35$ . The practical salinity scale may be applied to values 0 through 42.00 psu at temperatures between 0 to 35 °C.

Sal ppt: measurements expressed in ppt are based on the Natural Seawater Scale that extends from 0.00 to 80.00 g/L and covers 10 to 31 °C temperature range. It determines the salinity based upon a conductivity ratio of sample to standard seawater at 15 °C and an approximate salinity value of 35 in seawater.

Sal %: in this scale 100% salinity is equivalent to roughly 10% solids.

## User interface

- 7-inch capacitive touch screen with multi-touch support
- Capacitive touch back, home and system menu keys
- User-friendly icons and symbols allow users to easily navigate and interpret the instrument functions.
- The user can select between five different views:
  - Basic measurement configuration
  - Simple GLP with calibration information
  - Full GLP with electrode status and calibration point details
  - Live updated, interactive graph
  - Tabulated data with date, time, and notes

## Measurement

- Measure  $\mu\text{S}/\text{cm}$ ,  $\text{mS}/\text{cm}$  (Conductivity);  $\Omega\text{-cm}$ ,  $\text{k}\Omega\text{-cm}$ ,  $\text{M}\Omega\text{-cm}$  (Resistivity); ppm, ppt (TDS); ppt, PSU, % (Salinity) with temperature
- Application-specific profiles allow quick and direct measurement without the need to update the sensor and system settings

- Active log during measurement
- Measurement stability indicator (using the Stability Criteria setting)
- Reading modes: direct and direct/autohold
- Temperature compensation can be Automatic or set manually
- Audible and/or alarm messages for measurements outside of predefined limits
- Galvanic isolation for conductivity measurement

## Calibration

- Standard single point salinity calibration in 100% salinity standard, with the reading salinity scale set to %
- Standard single or multiple conductivity calibration with standards
- Non-volatile memory saves data and settings

## Logging

- Data log collection of at least 1,000,000 data points (with time and date stamp)
- Logging types: manual, automatic, autohold
- Sample ID for manual and Autohold data

## Connectivity features & services

- Transfer logged data to a USB thumb drive
- Log files that include measurements and calibration data (as .csv file)
- FTP and email for log export via Ethernet and Wi-Fi connection
- USB type A for USB stick, keyboard, and printer
- USB type C for USB stick and PC connection

## Help section for meter guidance

- Video support presentation of main functionalities





### 1. Capacitive touch screen with multi-touch support

The benchtop unit has a 7-inch color display with 800 x 480p resolution. The capacitive, multi-touch screen supports video playback and data plotting.

### 2. Back key

### 3. Home key

### 4. System Menu key

This key will enter the system menu where User accounts, System Settings, and Logging can be configured. The Help menu is also accessed on the system menu screen.

### 5. Stability indicator

### 6. Current date

### 7. Current time

### 8. Main reading

### 9. Probe icon

### 10. Calibration information: Electrode condition, Offset, Slope, Date and Time

### 11. Buffer trays

### 12. Temp. reading

### 13. Measurement setup menu

Opens sensor setup parameters.

### 14. User name (default shown)

### 15. Direct/Autohold Readings

When Direct/Autohold is selected, measurement reading is held on display when measurement stability is reached. This option removes the subjective nature of stability as a measurement that has not reached equilibrium will not be used.

When not selected, sample measurements are displayed continuously.

### 16. Logging space availability

### 17. Logging start

### 18. USB connection status

### 19. Peripheral connection status

### 20. Wireless network connection status

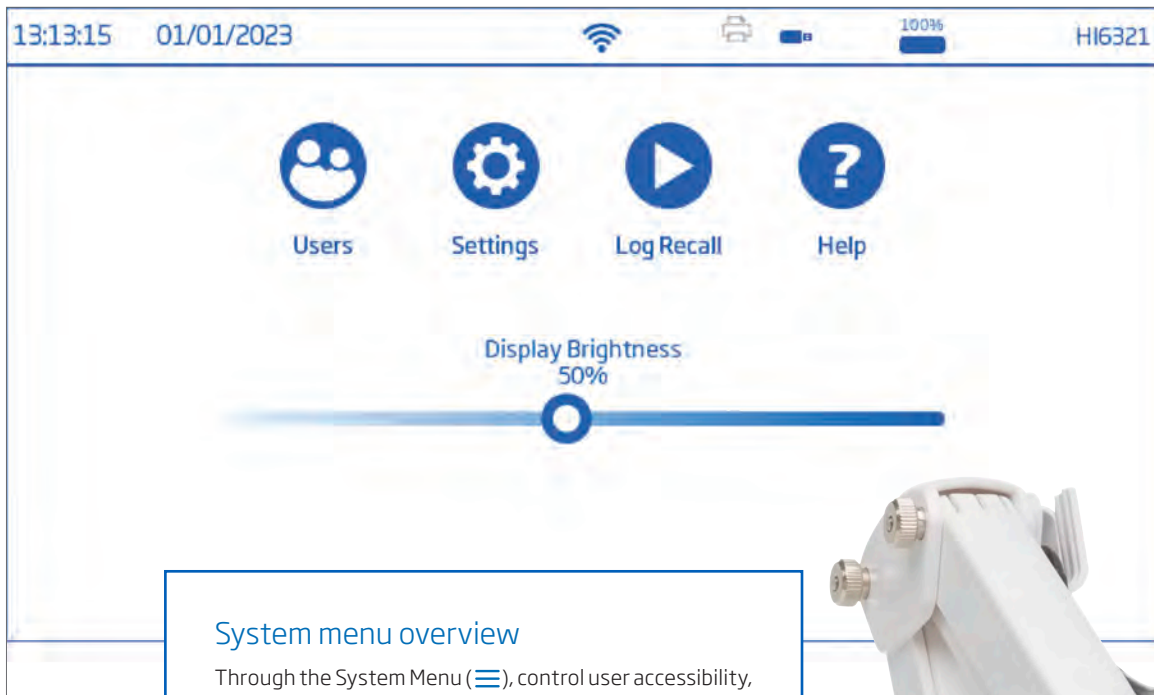

**System menu overview**

Through the System Menu (☰), control user accessibility, system and connectivity configuration, access logged data and video-supported help.

- Add and delete user accounts through Users (👤).
- Access Network Connectivity, System and Info tabs through Settings (⚙️).
- Log Recall (▶️) recalls stored log sessions (Automatic continuous logging, Manual, or Autohold).
- Help (❓) guides users with video-supported help.





## Users

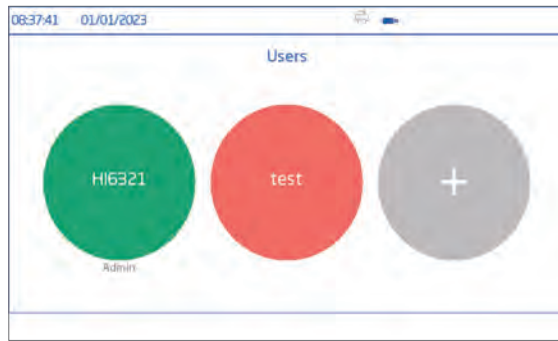

### Custom Users

New administrator or standard user accounts can be created. Standard accounts can be configured for specific accessibility.

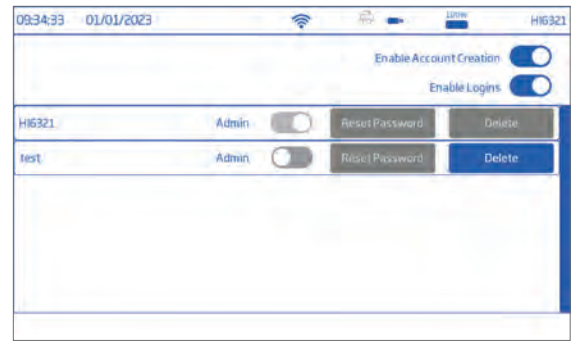

### User Account Management

Administrators can create and manage accounts from the Account Management Screen.



## Settings

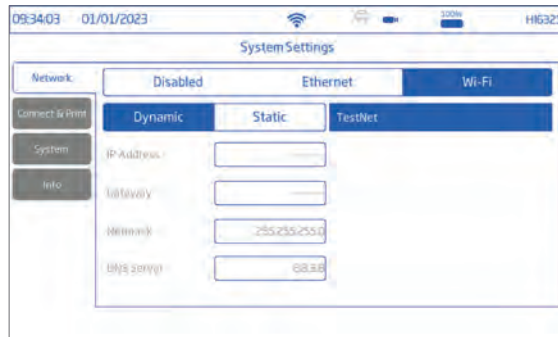

### Network Screen

Determine how measurement logs are shared through network settings. Users can select network to be connected via Ethernet or Wi-Fi, or Disabled.

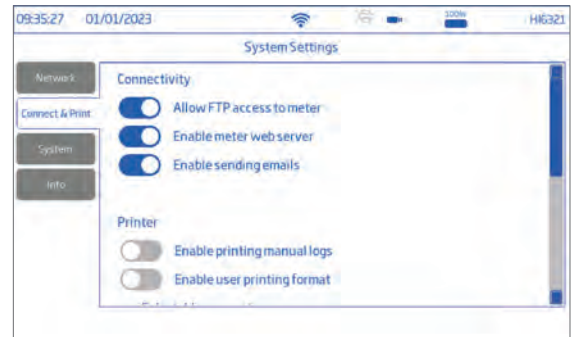

### Connect and Print Screen

Activate connectivity options to allow the meter to connect to other devices.

- FTP access to meter, permits log file transfer to a FTP site and to connect the meter FTP server to a client for log download.
- Meter web server, permits log file download to a web client.
- Sending emails, permits log files to be transferred by email.

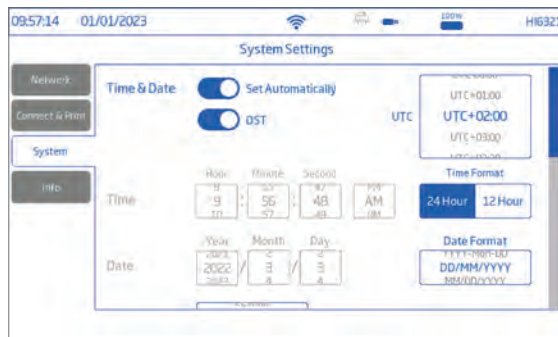

### System Screen

The system screen enables users to configure options such as: Time, Date, Language, Meter ID, Decimal Separator, Backlight Saver, Audible signals, Startup Tutorial, and Factory Settings restore.



### Info Screen

Displays information on meter, channel serial number, and Wi-Fi firmware version.



## Log Recall

Name	Parameter	Start/Stop	Share To
EC_20220303101404.csv	Conductivity	13:14:04 03/03/2022 13:14:30 03/03/2022	USB-A FTP Email Cancel
RES_20220303101447.csv	Resistivity	13:14:47 03/03/2022 13:14:50 03/03/2022	
SAL_20220303101507.csv	Salinity	13:15:07 03/03/2022 13:15:10 03/03/2022	
TDS_20220303101458.csv	TDS	13:14:50 03/03/2022 13:15:01 03/03/2022	

### Log History and Sharing

The item allows users access and management (selection, deletion, and sharing) of measurement data. Only the user who generated the data has access to the logs created by that user.

Data can be viewed tabulated (complete with date, time, and notes), or plotted (as graph).

Log files can be shared via USB, FTP, web server and email.

EC (uS/cm)	T(°C)	Date	Time	Notes
1416	25.0	03/03/2022	13:14:04	"H"
1416	25.0	03/03/2022	13:14:05	"H"
1416	25.0	03/03/2022	13:14:06	"H"
1416	25.0	03/03/2022	13:14:07	"H"
1416	25.0	03/03/2022	13:14:08	"H"
1416	25.0	03/03/2022	13:14:09	"H"
1416	25.0	03/03/2022	13:14:10	"H"

### Table View



### Graph View

GENERAL INFORMATION  
Username: H16321  
Profile: default\_EC

INSTRUMENT  
Instrument Name: H16321-101  
Serial Number: 123456789LMN  
Firmware Version: 0.1.230825

CHANNEL INFO  
Channel Number: 1  
Channel Name: EC

### Log Detail

Tapping the information icon displays log details such as user and profile name, instrument name and serial number, channel, lot information, as well as GLP data.



## Help

**Hanna Tutorial System**

- 1. H16321 First Look
- 2. Getting Started
  - 2.1. Get familiar with functionalities
  - 2.2. Users
  - 2.3. Meter settings
  - 2.4. Setting measurement
- 3. General Operations
- 4. General Operations
- 5. Troubleshooting guide
- 6. Accessories and Warranty

**2.1. Get familiar with functionalities**  
Screens explained  
Main View - This screen shows the current measurement according to the measurement settings and give access to the user calibration and measurement settings options.

Main Menu - This screen gives the user access to the 5 main icons

**Hanna Tutorial System**

- 1. H16321 First Look
- 2. Getting Started
  - 2.1. Get familiar with functionalities
  - 2.2. Users
  - 2.3. Meter settings
  - 2.4. Setting measurement
- 3. General Operations
- 4. General Operations
- 5. Troubleshooting guide
- 6. Accessories and Warranty

**2.4. Setting up measurement**  
Your measurement screen can be configured by pressing **Q**.

Channel Settings

READING

Mode: pH, mV, Rel. mV

### On-board Help

The HELP menu supports users with a brief overview of the system's main functionalities through text and video tutorials.



## Measurement Setup Configuration

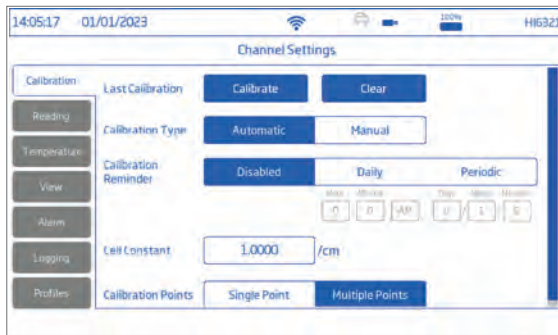

### Calibration

Customize calibration options such as Last Calibration, Calibration Type (Automatic, Manual), Calibration Reminder (Disabled, Daily, Periodic), Cell Constant, Calibration Points.

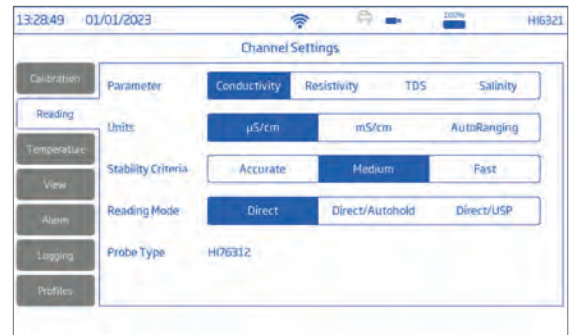

### Reading

Customize measurement options such as Parameter, Units, Stability Criteria, Reading Mode

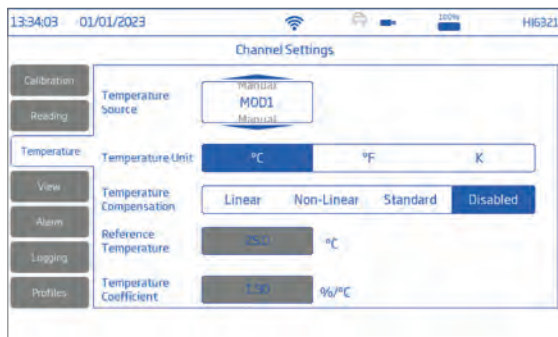

### Temperature

Customize temperature options such as Source, Unit (Celsius, Fahrenheit, Kelvin), compensation algorithm (Linear, Non-Linear, Standard, or Disabled), Reference Temperature, and Temperature Coefficient.

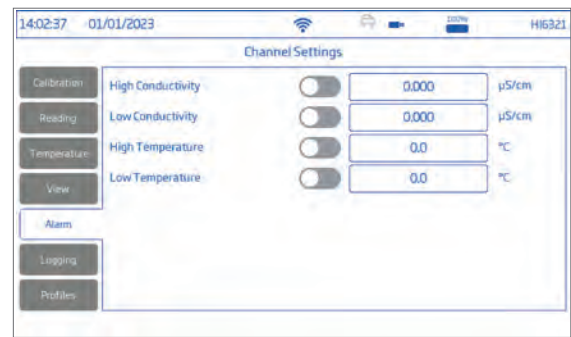

### Alarm configuration

Alarm configuration allows users to set the high and low threshold limits for the measured parameters. When the parameter is enabled and the measurement exceeds the high-limit value or drops below the low-limit value, the alarm is triggered and will appear on the message banner along with an audible alarm (if Alarm Beepers is enabled).

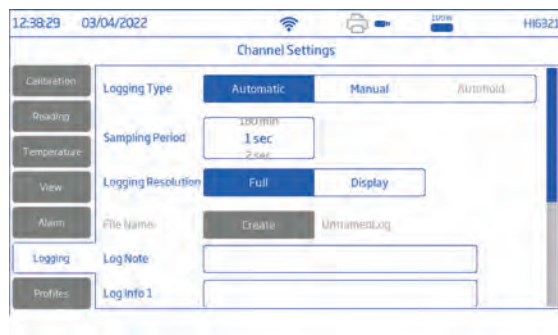

### Logging

Logging Type (automatic, manual or autohold), Sampling Period (Automatic), Logging Resolution, File Name (with Manual type selected), Log Note and Info, Sample ID (Increment or Manual) can be configured under this option menu.

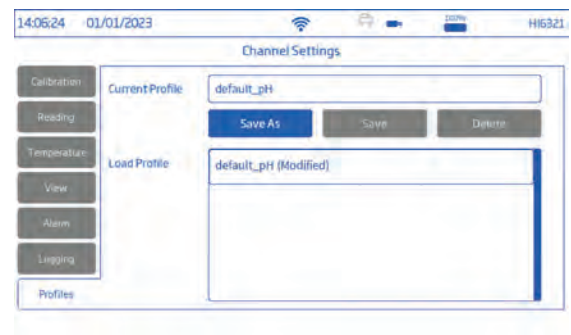

### Profiles

A profile is a sensor setup complete with required measurement unit, temperature unit, display preference, and alarm threshold options.

Once saved the profile can be loaded for applications that require similar configurations.



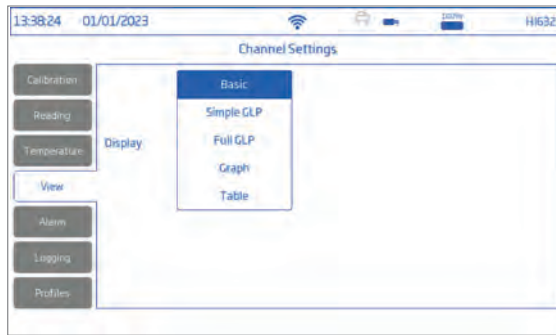

### View Configuration

Select the preferred display from the view screen. Option to select between: Basic, Simple GLP, Full GLP, Graph, Table.

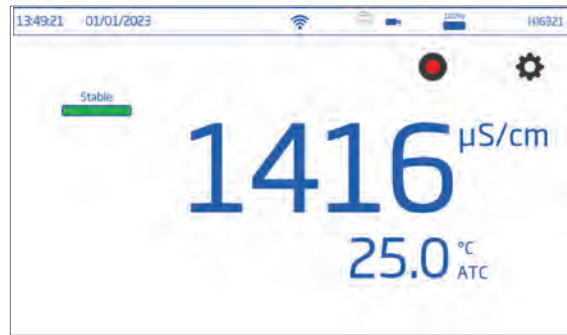

### Basic View

Basic screen displays the measured value, measurement unit as well as temperature source.



### Simple GLP View

In addition to data displayed when Basic option is selected, screen also displays: last calibration date and time and offset value.

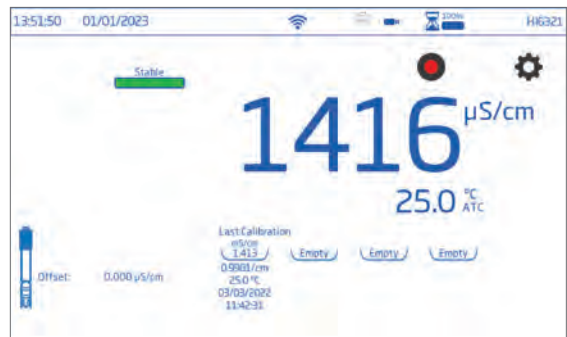

### Full GLP View

In addition to data displayed when Simple GLP option is selected, screen also displays: electrode symbol, used buffers trays together with calibration date and time.

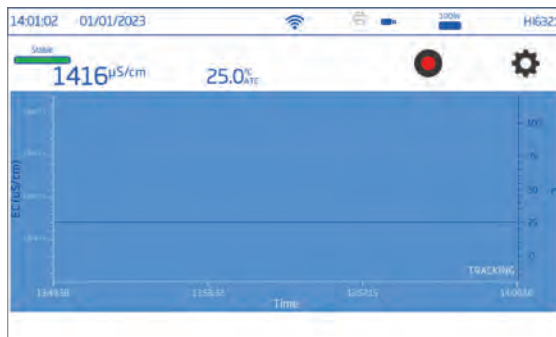

### Graph View

When Graph is selected, the measured value is plotted as a graph.

EC (μS/cm)	T (°C)	Time	Date	Notes
1416	25.0	14:01:37	31/08/2022	
1416	25.0	14:01:36	31/08/2022	
1416	25.0	14:01:35	31/08/2022	
1416	25.0	14:01:34	31/08/2022	
1416	25.0	14:01:33	31/08/2022	
1416	25.0	14:01:32	31/08/2022	
1416	25.0	14:01:31	31/08/2022	
1416	25.0	14:01:30	31/08/2022	
1416	25.0	14:01:29	31/08/2022	
1416	25.0	14:01:28	31/08/2022	
1416	25.0	14:01:27	31/08/2022	

### Table

When Table is selected, the measured values are displayed tabulated (complete with date, time, and notes made during logging). The newest data is displayed on the top of the table.

## Electrode Holder

HI6321 is supplied with an electrode holder featuring a flexible arm. The holder can be mounted on either side quickly and provides secure support for electrodes while taking measurements in sample containers.



## Rear Ports

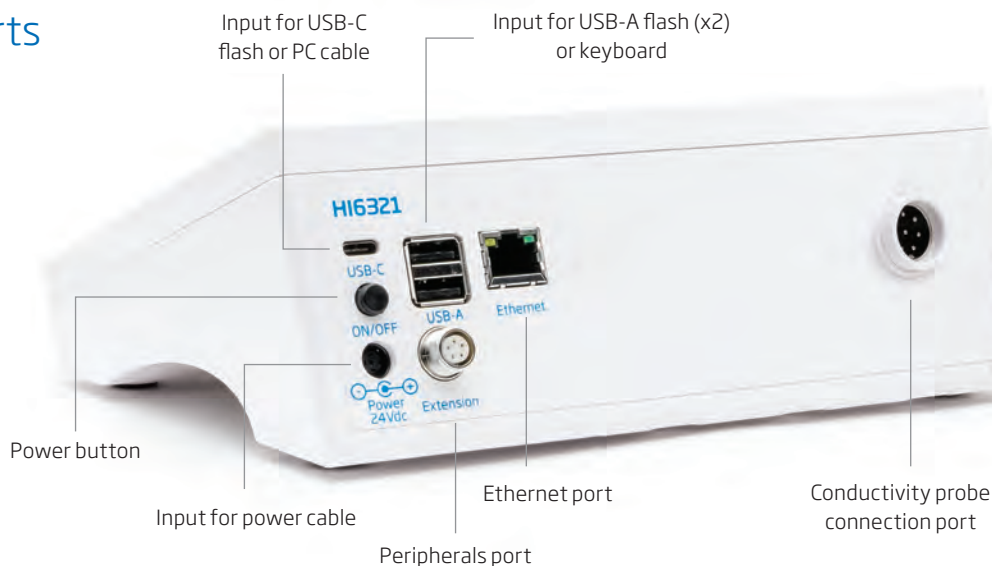

### Specifications

#### HI6321

Conductivity	Range	0.000 to 9.999 $\mu\text{S}/\text{cm}$ ; 10.00 to 99.99 $\mu\text{S}/\text{cm}$ ; 100.0 to 999.9 $\mu\text{S}/\text{cm}$ ; 1.000 to 9.999 $\text{mS}/\text{cm}$ ; 10.00 to 99.99 $\text{mS}/\text{cm}$ ; 100.0 to 1000.0 $\text{mS}/\text{cm}$
	Resolution	0.001 $\mu\text{S}/\text{cm}$ ; 0.01 $\mu\text{S}/\text{cm}$ ; 0.1 $\mu\text{S}/\text{cm}$ ; 0.001 $\text{mS}/\text{cm}$ ; 0.01 $\text{mS}/\text{cm}$ ; 0.1 $\text{mS}/\text{cm}$
	Accuracy	$\pm 1\%$ of reading ( $\pm 0.01 \mu\text{S}/\text{cm}$ )
Resistivity	Range	1.0 to 99.9 $\Omega\text{-cm}$ ; 100 to 999 $\Omega\text{-cm}$ ; 1.00 to 9.99 $\text{K}\Omega\text{-cm}$ ; 10.0 to 99.9 $\text{K}\Omega\text{-cm}$ ; 100 to 999 $\text{K}\Omega\text{-cm}$ ; 1.00 to 9.99 $\text{M}\Omega\text{-cm}$ ; 10.0 to 100.0 $\text{M}\Omega\text{-cm}$
	Resolution	0.1 $\Omega\text{-cm}$ ; 1 $\Omega\text{-cm}$ ; 0.01 $\text{K}\Omega\text{-cm}$ ; 0.1 $\text{K}\Omega\text{-cm}$ ; 1 $\text{K}\Omega\text{-cm}$ ; 0.01 $\text{M}\Omega\text{-cm}$ ; 0.1 $\text{M}\Omega\text{-cm}$
	Accuracy	$\pm 1\%$ of reading ( $\pm 1 \Omega\text{-cm}$ )

Total Dissolved Solids (TDS)	Range	0.000 to 9.999 ppm; 10.00 to 99.99 ppm; 100.0 to 999.9 ppm; 1.000 to 9.999 ppt; 10.00 to 99.99 ppt; 100.0 to 400.0 ppt; actual TDS (with 1.00 factor)
	Resolution	0.001 ppm; 0.01 ppm; 0.1 ppm; 0.001 ppt; 0.01 ppt; 0.1 ppt
	Accuracy	±1 % of reading (±0.01 ppm)
Salinity	Range	0.00 to 42.00 PSU - Practical Scale 0.00 to 80.00 ppt - Natural Sea Water 0.0 to 400.0 % - Percent Scale
	Resolution	0.01 for Practical Scale / Natural Sea Water 0.1 % for Percent Scale
	Accuracy	±1 % of reading
Temperature	Range	-20.0 to 120.0 °C -4.0 to 248.0 °F 253.0 to 393.0 K
	Resolution	0.1 °C; 0.1 °F; 0.1 K
	Accuracy	±0.2 °C; ±0.4 °F; ±0.2 K
Conductivity Calibration	Calibration points	Auto standard recognition / User standard, Single Point / Multi Point calibration
	Standard solutions	84.00 µS/cm, 1.413 mS/cm, 5.000 mS/cm, 12.88 mS/cm, 80.00 mS/cm, 111.8 mS/cm
	Reminder	Disabled Daily: 0 min. to 23 hours and 59 min. Periodic: 1 min. to 500 days, 23 hours and 59 min.
Resistivity Calibration	Uses Conductivity	
Salinity Calibration	1 point for Percent Scale	
Temperature Compensation	Automatic or Manual	
Reading	Modes	Direct Direct/Autohold
	Stability criteria	Accurate Medium Fast
	Sampling rate	1000 ms
EC Views	Basic	Measurement (EC, Resistivity, TDS, Salinity, Temperature) Stability status
	Simple GLP	Basic view information Last calibration date, offset
	Full GLP	Simple GLP information and calibration point details
	Table	Measurements updated every second are displayed in table
	Graph (Plot)	Measurement versus time graph can be panned or zoomed (pinch-to-zoom technology)
Logging	Type	Automatic, Manual, Autohold
	Number of records	50 000 maximum per file Stores at least 1 000 000 data points per user
	Automatic interval	1, 2, 5, 10, 30 seconds 1, 2, 5, 10, 15, 30, 60, 120, 150, 180 minutes
	Sample ID	Incremental mode
	Export option	.csv file format
Users	Up to 9 users and the default administrator account	
Connectivity	USB-A	2 ports for keyboard input or USB thumb drive
	USB-C	1 port for PC connectivity and USB-C type thumb drive
	Wi-Fi & Ethernet	FTP Web server Log transfer and download Email
	RS232	Connecting peripherals
Power supply	DC adapter 100-240AC to 24VDC 2.5A	
Environment	0 - 50 °C / 32 - 122 °F / 273 - 323 K maximum 95% RH non-condensing	
Dimensions	205 x 160 x 77 mm (8.0 x 6.2 x 3.0")	
Weight	Approximately 1.2 kg (26.5 lbs.)	
Ordering Information	<b>HI6321</b> is supplied with HI7631233 probe; HI764060 electrode holder; capillary pipette; 24 VDC power adapter; USB-C to USB-A cable; probe quality certificate; quick reference guide with instrument quality certificate.	

# Research Grade Conductivity/TDS Meter

EC/TDS/Resistivity/Salinity and Temperature  
with USP <645>

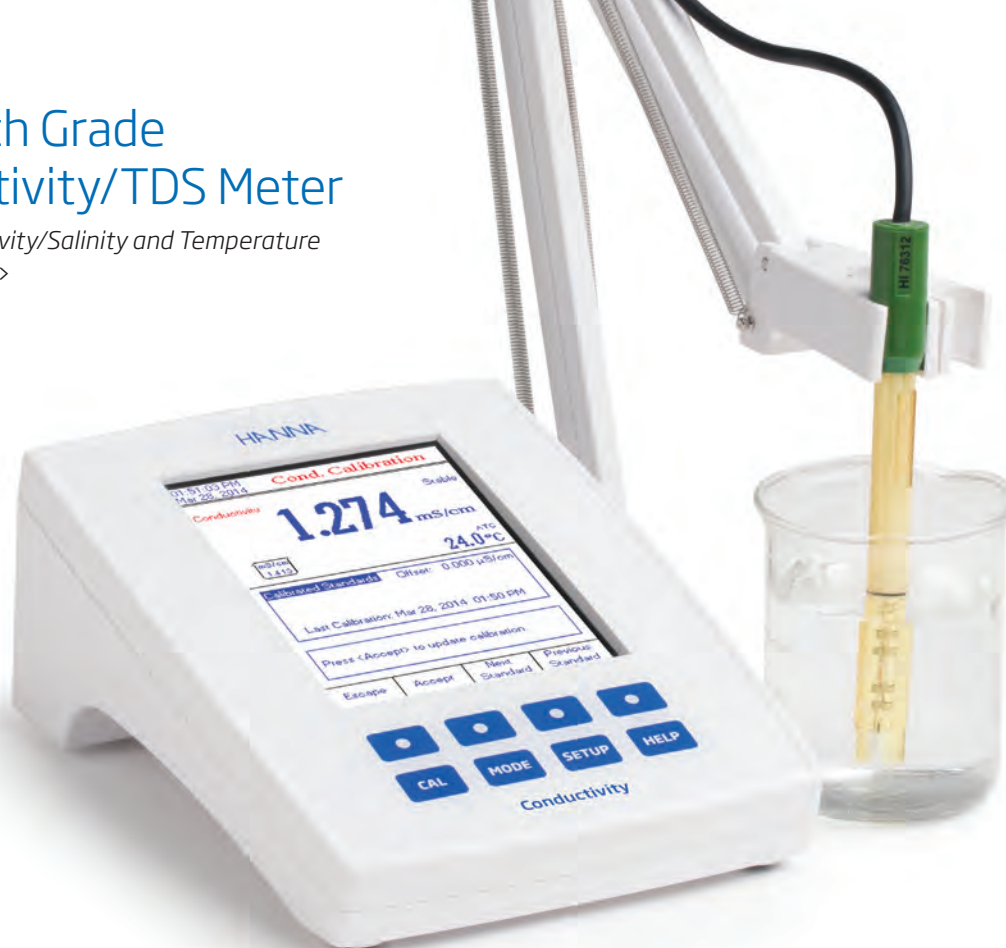

The HI5321 is an advanced research grade benchtop EC/TDS/Salinity/Resistivity meter that is completely customizable with a large color LCD, capacitive touch keys, and USB port for computer connectivity.

## Customizable User Interface

The user interface of the HI5321 allows the user to show measurements in various modes: basic measurement with or without GLP information, real-time graphing, and logging data. Calibration stability criteria can be adjusted from fast, moderate, and accurate. Programmable alarm limits can be set to inside or outside allowable limits.

## Color Graphic LCD

The HI5321 features a color graphic LCD with on-screen help, graphic, and custom color configurations. The display allows for real-time graphing.

## Capacitive Touch

The HI5321 features sensitive capacitive touch buttons for accurate keystrokes when navigating menus and screens.

## Auto-ranging

The meter can be set to auto-ranging in which the meter chooses the appropriate conductivity range from seven ranges or fixed range in which the meter will only display reading in  $\mu\text{S}/\text{cm}$  or  $\text{mS}/\text{cm}$ .

## Automatic Temperature Compensation

All readings are automatically compensated for temperature variations with a built in temperature sensor.

## Calibration

The HI5321 can be calibrated up to four points with a choice of six pre-programmed conductivity standards or user defined custom standards. Resistivity, TDS, Practical Salinity (PSU) and Natural Seawater Scale are calibrated through conductivity. The % NaCl is calibrated to single point with the HI7037 salinity standard.

## GLP Data

HI5321 includes a GLP Feature that allows users to view calibration data and calibration expiration information at the touch of a key. Calibration data include date, time, standards used for calibration.

## Data Logging

Three selectable logging modes are available on the HI5321: automatic, manual, and AutoHold logging. Automatic and manual logs up to 100 lots with 50,000 records max/lot, with up to 100,000 total data points. Automatic logging features the option to save data according to sampling period and interval.

## Data Transfer

Data can be transferred to a PC with USB cable and HI92000 software (both sold separately).

## Contextual Help

Contextual help is always available through a dedicated "HELP" key

## Four-ring Conductivity Probe

All readings are performed with the HI76312 four-ring conductivity probe with a built in temperature sensor for automatic temperature correction. The four rings are made with platinum and the body of the electrode is made of Polyetherimide (PEI) plastic that is resistant to many harsh chemicals.

## USP &lt;645&gt;

For the measurement of high purity water used in pharmaceutical manufacturing, the HI5321 is programmed with the first two stages of the USP <645> method. Once a stage is met a report is generated and can be saved. Up to 200 reports can be stored and transferred to a Windows® compatible computer using a USB cable and software (sold separately).



## Specifications

## HI5321

EC	Range	0.000 to 9.999 $\mu\text{S}/\text{cm}$ ; 10.00 to 99.99 $\mu\text{S}/\text{cm}$ ; 100.0 to 999.9 $\mu\text{S}/\text{cm}$ ; 1.000 to 9.999 $\text{mS}/\text{cm}$ ; 10.00 to 99.99 $\text{mS}/\text{cm}$ ; 100.0 to 1000.0 $\text{mS}/\text{cm}$
	Resolution	0.001 $\mu\text{S}/\text{cm}$ ; 0.01 $\mu\text{S}/\text{cm}$ ; 0.1 $\mu\text{S}/\text{cm}$ ; 0.001 $\text{mS}/\text{cm}$ ; 0.01 $\text{mS}/\text{cm}$ ; 0.1 $\text{mS}/\text{cm}$
	Accuracy	$\pm 1\%$ of reading ( $\pm 0.01 \mu\text{S}/\text{cm}$ )
	Cell Constant	0.0500 to 200.00/cm
	Cell Type	4 cells
	Calibration	automatic standard recognition, user standard, single point / multi-point calibration
	EC Calibration Solution	84.00 $\mu\text{S}/\text{cm}$ , 1.413 $\text{mS}/\text{cm}$ , 5.000 $\text{mS}/\text{cm}$ , 12.88 $\text{mS}/\text{cm}$ , 80.00 $\text{mS}/\text{cm}$ , 111.8 $\text{mS}/\text{cm}$
	Calibration Reminder	yes
	Temperature Compensation	disabled, linear and non-linear (natural water)
	Temperature Coefficient	0.00 to 10.00 %/ $^{\circ}\text{C}$
	Reference Temperature	5.0 to 30.0 $^{\circ}\text{C}$
	Profiles	up to 10
USP <645> Application	yes	
TDS	Range	0.000 to 9.999 ppm; 10.00 to 99.99 ppm; 100.0 to 999.9 ppm; 1.000 to 9.999 ppt; 10.00 to 99.99 ppt; 100.0 to 400.0 ppt actual TDS (with 1.00 factor)
	Resolution	0.001 ppm; 0.01 ppm; 0.1 ppm; 0.001 ppt; 0.01 ppt; 0.1 ppt
	Accuracy	$\pm 1\%$ of reading ( $\pm 0.01 \text{ppm}$ )
Resistivity	Range	1.0 to 99.9 $\Omega \cdot \text{cm}$ ; 100 to 999 $\Omega \cdot \text{cm}$ ; 1.00 to 9.99 $\text{k}\Omega \cdot \text{cm}$ ; 10.0 to 99.9 $\text{k}\Omega \cdot \text{cm}$ ; 100 to 999 $\text{k}\Omega \cdot \text{cm}$ ; 1.00 to 9.99 $\text{M}\Omega \cdot \text{cm}$ ; 10.0 to 100.0 $\text{M}\Omega \cdot \text{cm}$
	Resolution	0.1 $\Omega \cdot \text{cm}$ ; 1 $\Omega \cdot \text{cm}$ ; 0.01 $\text{k}\Omega \cdot \text{cm}$ ; 0.1 $\text{k}\Omega \cdot \text{cm}$ ; 1 $\text{k}\Omega \cdot \text{cm}$ ; 0.01 $\text{M}\Omega \cdot \text{cm}$ ; 0.1 $\text{M}\Omega \cdot \text{cm}$
	Accuracy	$\pm 1\%$ of reading ( $\pm 1 \Omega \cdot \text{cm}$ )
Calibration	Uses Conductivity	
Salinity	Range	practical scale: 0.00 to 42.00 psu; natural sea water scale: 0.00 to 80.00 ppt; percent scale: 0.0 to 400.0%
	Resolution	0.01 for practical scale/natural sea water scale; 0.1% for percent scale
	Accuracy	$\pm 1\%$ of reading
Calibration	percent scale – one-point (with HI7037 standard)	
Temperature*	Range	-20.0 to 120.0 $^{\circ}\text{C}$ ; -4.0 to 248.0 $^{\circ}\text{F}$ ; 253.15 to 393.15K
	Resolution	0.1 $^{\circ}\text{C}$ ; 0.1 $^{\circ}\text{F}$ ; 0.1K
	Accuracy	$\pm 0.2^{\circ}\text{C}$ ; $\pm 0.4^{\circ}\text{F}$ ; $\pm 0.2\text{K}$ (without probe)
Calibration	User calibration in 3 points (0, 50, 100 $^{\circ}\text{C}$ )	
Additional Specifications	EC Probe	HI76312 platinum, four-ring EC/TDS probe with and 1 m (3.3') cable (included)
	GLP	Probe cell constant / offset, reference temperature, compensation coefficient, calibration points, calibration time stamp
	Logging	<b>record</b> : Up to 100 lots, 50,000 records max/lot / maximum 100,000 data points; <b>interval</b> : 14 selectable between 1 second and 180 minutes; <b>type</b> : Automatic, Log on demand, AutoHold; <b>additional</b> : 200 records USP
	PC Connection	Opto-isolated USB
	Power Supply	12 VDC adapter (included)
	Environment	0 to 50 $^{\circ}\text{C}$ (32 to 122 $^{\circ}\text{F}$ ; 273 to 323K) RH max 95% non-condensing
	Dimensions / Weight	160 x 231 x 94 mm (6.3 x 9.1 x 3.7") / 1.2 kg (2.64 lbs.)
Ordering Information	<b>HI5321-01</b> (115V) and <b>HI5321-02</b> (230V) are supplied with HI76312 EC/TDS probe, 1413 $\mu\text{S}/\text{cm}$ conductivity standard sachet (4), 12880 $\mu\text{S}/\text{cm}$ conductivity standard sachet (2), 5000 $\mu\text{S}/\text{cm}$ conductivity standard sachet (2), electrode rinse solution sachet (2), HI76404W electrode holder, 12 VDC adapter, capillary dropper pipette, quality certificate, quick start guide and instruction manual.	

(\*) Reduced to actual probe limits



## The world's most innovative pH, EC and DO meter

edge's groundbreaking design is the culmination of Hanna's vision, design capabilities, integrated production and world class R&D. The edge is rich in features to accommodate the needs of a vast amount of customers. For those that prefer very simplistic operation there is a basic mode operation with simplified menu and options while for those who require advanced features there is the full featured standard operating mode. edge is available as a pH, conductivity or dissolved oxygen kit and any edge kit can be upgraded with additional probes to measure pH, conductivity and dissolved oxygen.

## edge® technical features

### Rechargeable Battery

edge has a built in rechargeable battery that is charged when the meter is in the plugged in benchtop or wall mount cradle. The battery can also be recharged through the micro USB port with either a USB port from a computer or directly to the power supply.



### Two USB ports

edge includes one standard USB for exporting data to a flash drive. edge also includes one micro USB port for exporting files to your computer as well as for charging when the cradle is not available.



### Clear, full text readout

edge features clear, full text guides displayed on the bottom of the screen. There is no need to decipher scrambled abbreviations or symbols; these helpful messages guide you through every process quickly and easily.



### Data logging

edge allows you to store up to 1000 log records of data. Data sets include readings, GLP data, date and time.

\* Using edge compatible pH electrodes



### GLP

Data of the last calibration you perform is stored in the sensor including the date, time, and buffers used. When the sensor is connected to edge, GLP data is automatically transferred.

### Two Operating Modes

edge can be used in Extended or Basic Operating Modes. Extended Mode enables all edge features while Basic Mode reduces features—ideal for routine measurements by displaying a simplified screen and features.

### edge pH Features\*



### CAL Check™ (pH only)

Hanna's exclusive CAL Check feature analyzes the pH electrode response in the pH buffers during the calibration process to alert the user of potential problems such as a contaminated buffer or dirty electrode. After calibration, indicators for probe condition are displayed on the measurement screen. The probe condition is based on offset and slope characteristics of the pH electrode.

### Sensor Check™ (pH only)

When used with Hanna's electrodes equipped with a matching pin, edge constantly checks the impedance of the pH measuring electrode to notify you in real time in the event of glass breakage. During calibration, Sensor Check checks the state of the junction. The reference junction is also evaluated and reported on the display.

### ORP Measurement

edge measures ORP with edge compatible ORP probes.

## edge design features



### Capacitive touch keypad

edge features sensitive capacitive touch buttons for accurate keystrokes when navigating edge's menus and screens. Since they are part of the screen, the buttons can never get clogged with sample residue.



### Easy to read LCD

edge features a 5.5" (14 cm) LCD display that you can clearly view from over 5 m (16.4'). The large display, with its wide 150° viewing angle, provides one of the easiest to read LCDs in the industry.



### Zero footprint

Using the wall mount cradle (included), edge can be placed on a wall, leaving zero footprint on the benchtop space. The cradle has a built-in connector to power and charge the batteries.



## Hybrid meters that can be used in portable, wall-mount and benchtop configurations

The versatile design of edge® enables it to be used as a portable, wall-mount or benchtop meter. edge simplifies measurement, configuration, calibration, diagnostics, logging and transferring data directly to a computer or USB drive.



### Portable field unit

edge is ideal for field use due to its light weight, large screen, and thin design. It can easily be slipped into a backpack or messenger bag. The battery life lasts up to 8 hours when used as a portable device.



### Wall-mount cradle

The included wall-mount cradle makes it easy to conserve space on the benchtop while also charging edge with the AC adapter. The cradle is ideal for continuous monitoring applications.



### Electrode holder with built-in cradle

The electrode holder features a swivel, adjustable arm with a built-in cradle to hold edge securely in place at the optimum viewing angle.





## Digital electrodes

edge® measures pH, conductivity and dissolved oxygen through its unique digital electrodes. These digital electrodes are auto-recognized, providing sensor type, calibration data and a serial number when connected to edge by an easy to plug-in 3.5mm connector.

- Simply connect each probe via the 3.5 mm jack, Digital Smart Electrodes are automatically recognized

- **Digital four-ring conductivity probe**
  - Covers all ranges from 0.00  $\mu\text{S}/\text{cm}$  to 500  $\text{mS}/\text{cm}$  (absolute EC)
- **Accuracy**
  - $\pm 1\%$  of the reading ( $\pm 0.05 \mu\text{S}/\text{cm}$  or 1 digit, whichever is greater)
- **Calibration**
  - Offset (0  $\mu\text{S}/\text{cm}$ ) and cell factor calibration
  - Choice of five standards (auto-recognition)
- **Data logging**
  - Manual log-on-demand
  - Manual log-on-stability
  - Interval logging
- **Auto-ranging or manual range selection**
- **EC, TDS and salinity reading modes**
- **Temperature compensation**
  - Automatic
  - NoTC (absolute)
- **GLP data**
  - Records date, time, offset and cell factor
- Data of the last performed calibration is stored in the probe: date, time, cell constant, temperature coefficient, reference temperature and battery status. When the probe is connected to edge®EC, GLP data is automatically transferred
- **Adjustable EC to TDS conversion factor**
- **Adjustable temperature correction coefficient**
- **Seawater salinity units**
  - % NaCl
  - PSU
  - g/L



### Sleek design

Incredibly thin and lightweight, edge measures just 1/2" (12 mm) thick and weighs just 8.8 ounces (250 g).

All edge compatible pH, EC and dissolved oxygen digital probes are interchangeable with edge.

Specifications	HI2030 edge	
EC	Range	0.00 to 29.99 $\mu\text{S}/\text{cm}$ ; 30.0 to 299.9 $\mu\text{S}/\text{cm}$ ; 300 to 2999 $\mu\text{S}/\text{cm}$ ; 3.00 to 29.99 $\text{mS}/\text{cm}$ ; 30.0 to 200.0 $\text{mS}/\text{cm}$ ; up to 500.0 $\text{mS}/\text{cm}$ absolute EC**
	Resolution	0.01 $\mu\text{S}/\text{cm}$ ; 0.1 $\mu\text{S}/\text{cm}$ ; 1 $\mu\text{S}/\text{cm}$ ; 0.01 $\text{mS}/\text{cm}$ ; 0.1 $\text{mS}/\text{cm}$
	Accuracy (@25°C/77°F)	$\pm 1\%$ of reading ( $\pm 0.05 \mu\text{S}/\text{cm}$ or 1 digit, whichever is greater)
	Calibration	single cell factor calibration; six standards available: 84 $\mu\text{S}/\text{cm}$ , 1413 $\mu\text{S}/\text{cm}$ , 5.00 $\text{mS}/\text{cm}$ , 12.88 $\text{mS}/\text{cm}$ , 80.0 $\text{mS}/\text{cm}$ , 111.8 $\text{mS}/\text{cm}$ , one point offset: 0.00 $\mu\text{S}/\text{cm}$
	Temperature Coefficient	0.00 to 6.00%/°C (for EC and TDS only), default value is 1.90%/°C
TDS	Range	0.00 to 14.99 $\text{mg}/\text{L}$ (ppm); 15.0 to 149.9 $\text{mg}/\text{L}$ (ppm); 150 to 1499 $\text{mg}/\text{L}$ (ppm); 1.50 to 14.99 $\text{g}/\text{L}$ ; 15.0 to 100.0 $\text{g}/\text{L}$ ; up to 400.0 $\text{g}/\text{L}$ absolute TDS using 0.80 conversion factor**
	Resolution	0.01 $\text{mg}/\text{L}$ (ppm); 0.1 $\text{mg}/\text{L}$ (ppm); 1 (ppm); 0.01 $\text{g}/\text{L}$ ; 0.1 $\text{g}/\text{L}$
	Accuracy (@25°C/77°F)	$\pm 1\%$ of reading ( $\pm 0.03 \text{ppm}$ or 1 digit, whichever is greater)
	Calibration	through EC calibration
	TDS Factor	0.40 to 0.80 (default value is 0.50)
Salinity†	Range	0.0 to 400.0 % NaCl; 2.00 to 42.00 PSU; 0.0 to 80.0 $\text{g}/\text{L}$
	Resolution	0.1 % NaCl; 0.01 PSU; 0.01 $\text{g}/\text{L}$
	Accuracy (@25°C/77°F)	$\pm 1\%$ of reading
	Calibration	PSU and $\text{g}/\text{L}$ through EC calibration; % NaCl – one-point with HI7037 sea water standard
Temperature	Range*	-20.0 to 120.0°C; -4.0 to 248.0°F
	Resolution	0.1°C; 0.1°F
	Accuracy	$\pm 0.5^\circ\text{C}$ ; $\pm 0.9^\circ\text{F}$
Additional Specifications	Probe (included in EC kit)	HI763100 digital four-ring conductivity probe with 3.5 mm (1/8") connector and 1 m (3.3') cable
	Logging	up to 1000† (400 for basic mode) records organized in: manual log-on-demand (max. 200 logs), manual log-on-stability (max. 200 logs), interval logging† (max. 600 samples; 100 lots)
	Connectivity	1 USB port for storage; 1 micro USB port for charging and PC connectivity
	Environment	0 to 50°C (32 to 122°F); RH max 95% non-condensing
	Power Supply	5 VDC adapter (included)
	Dimensions / Weight	202 x 140 x 12 mm (7.9" x 5.5" x 0.5") / 250 g (8.82 oz.)
Ordering Information	<b>HI2030-01</b> (115V) and <b>HI2030-02</b> (230V) EC kit also includes: HI763100 Conductivity probe, 1413 $\mu\text{S}/\text{cm}$ conductivity standard sachets (4), 12880 $\mu\text{S}/\text{cm}$ conductivity standard sachets (2), 5000 $\mu\text{S}/\text{cm}$ conductivity standard sachets (2), and electrode rinse solution sachets (2). All edge compatible pH, EC and DO digital probes are interchangeable with HI2030 and can be ordered separately.	

\* temperature limits will be reduced to actual probe limits \*\* with temperature compensation function disabled  
 † standard mode only



## edge<sup>®</sup>EC–Innovation in a Single Parameter

edge EC's groundbreaking design is the culmination of Hanna's vision, design capabilities, integrated production and world class R&D. edge EC is a single meter that can measure EC, TDS, and salinity..

### Additional feature information

- **Digital four-ring conductivity probe**
  - Covers all ranges from 0.00  $\mu\text{S}/\text{cm}$  to 500  $\text{mS}/\text{cm}$  (absolute EC)
- **Accuracy**
  - $\pm 1\%$  of the reading ( $\pm 0.05 \mu\text{S}/\text{cm}$  or 1 digit, whichever is greater)
- **Calibration**
  - Offset (0  $\mu\text{S}/\text{cm}$ ) and cell factor calibration
  - Choice of 5 standards (auto-recognition)
- **Data logging**
  - Manual log-on-demand
  - Manual log-on-stability
  - Interval logging
- **GLP data**
  - Records date, time, offset and cell factor
  - Data of the last performed calibration is stored in the probe: date, time, cell constant, temperature coefficient, reference temperature and battery status. When the probe is connected to edge<sup>®</sup>EC, GLP data is automatically transferred
- **Auto-ranging or manual range selection**
- **EC, TDS and salinity reading modes**
- **Temperature compensation**
  - Automatic
  - NoTC (absolute)
- **Adjustable EC to TDS conversion factor**
- **Adjustable temperature correction coefficient**
- **Seawater salinity units**
  - % NaCl
  - PSU
  - g/L

## edge®EC technical features

### Rechargeable Battery

edge EC has a built in rechargeable battery that is charged when the meter is in the plugged in benchtop or wall mount cradle. The battery can also be recharged through the micro USB port with either a USB port from a computer or directly to the power supply.



### Two USB ports

edge EC includes one standard USB for exporting data to a flash drive. edge EC also includes one micro USB port for exporting files to your computer as well as for charging when the cradle is not available.



### Clear, full text readout

edge features clear, full text guides displayed on the bottom of the screen. There is no need to decipher scrambled abbreviations or symbols; these helpful messages guide you through every process quickly and easily.



### Data logging

edge EC allows you to store up to 1000 log records of data. Logging data sets include readings, GLP data, date and time.



### GLP

Data of the last calibration you perform is stored in the sensor including the date, time, and buffers used. When the sensor is connected to edge EC, GLP data is automatically transferred.

### Two Operating Modes

edge EC can be used in Extended or Basic Operating Modes. Extended Mode enables all edge features while Basic Mode reduces features—ideal for routine measurements by displaying a simplified screen and features.

## edge EC design features



### Capacitive touch keypad

edge EC features sensitive capacitive touch buttons for accurate keystrokes when navigating edge's menus and screens. Since they are part of the screen, the buttons can never get clogged with sample residue.



### Easy to read LCD

edge EC features a 5.5" (14 cm) LCD display that you can clearly view from over 5 m (16.4'). The large display, with its wide 150° viewing angle, provides one of the easiest to read LCDs in the industry.



### Zero footprint

Using the wall mount cradle (included), edge EC can be placed on a wall, leaving zero footprint on the benchtop space. The cradle has a built-in connector to power and charge the batteries.



### 3.5 mm probe input

Plugging an electrode in has never been simpler; no alignments or broken pins, simply connect the 3.5 mm plug and begin. Digital electrodes are automatically recognized.



### Sleek design

Incredibly thin and lightweight, edge measures just 1/2" (12 mm) thick and weighs just 8.8 ounces (250 g).

### Accepts edge EC compatible conductivity probe



## A hybrid meter that can be used in portable, wall-mount and benchtop configurations

The versatile design of edge®EC enables it to be used as a portable, wall-mount or benchtop meter. edge EC simplifies measurement, configuration, calibration, diagnostics, logging and transferring data directly to a computer or USB drive.



### Portable field unit

edge EC is ideal for field use due to its light weight, large screen, and thin design. It can easily be slipped into a backpack or messenger bag. The battery life lasts up to 8 hours when used as a portable device.



### Wall-mount cradle

The included wall-mount cradle makes it easy to conserve space on the benchtop while also charging edge EC with the AC adapter. The cradle is ideal for continuous monitoring applications.



### Electrode holder with built-in cradle

The electrode holder features a swivel, adjustable arm with a built-in cradle to hold edge EC securely in place at the optimum viewing angle.

## Digital electrodes

edge®EC performs measurements through its unique digital electrodes. These digital electrodes are auto-recognized, providing sensor type, calibration data and a serial number when connected to edge EC by an easy to plug-in 3.5 mm connector.

## Conductivity probe

### HI763100 (included)

Conductivity probe with temperature sensor

Recommended for general purpose



Specifications	HI2003 edge EC	
EC	Range	0.00 to 29.99 $\mu\text{S}/\text{cm}$ ; 30.0 to 299.9 $\mu\text{S}/\text{cm}$ ; 300 to 2999 $\mu\text{S}/\text{cm}$ ; 3.00 to 29.99 $\text{mS}/\text{cm}$ ; 30.0 to 200.0 $\text{mS}/\text{cm}$ ; up to 500.0 $\text{mS}/\text{cm}$ absolute EC**
	Resolution	0.01 $\mu\text{S}/\text{cm}$ ; 0.1 $\mu\text{S}/\text{cm}$ ; 1 $\mu\text{S}/\text{cm}$ ; 0.01 $\text{mS}/\text{cm}$ ; 0.1 $\text{mS}/\text{cm}$
	Accuracy (@25°C/77°F)	$\pm 1\%$ of reading ( $\pm 0.05 \mu\text{S}/\text{cm}$ or 1 digit, whichever is greater)
	Calibration	single cell factor calibration; six standards available: 84 $\mu\text{S}/\text{cm}$ , 1413 $\mu\text{S}/\text{cm}$ , 5.00 $\text{mS}/\text{cm}$ , 12.88 $\text{mS}/\text{cm}$ , 80.0 $\text{mS}/\text{cm}$ , 111.8 $\text{mS}/\text{cm}$ , one point offset: 0.00 $\mu\text{S}/\text{cm}$
	Temperature Coefficient	0.00 to 6.00%/°C (for EC and TDS only), default value is 1.90%/°C
TDS	Range	0.00 to 14.99 $\text{mg}/\text{L}$ (ppm); 15.0 to 149.9 $\text{mg}/\text{L}$ (ppm); 150 to 1499 $\text{mg}/\text{L}$ (ppm); 1.50 to 14.99 $\text{g}/\text{L}$ ; 15.0 to 100.0 $\text{g}/\text{L}$ ; up to 400.0 $\text{g}/\text{L}$ absolute TDS using 0.80 conversion factor**
	Resolution	0.01 $\text{mg}/\text{L}$ (ppm); 0.1 $\text{mg}/\text{L}$ (ppm); 1 (ppm); 0.01 $\text{g}/\text{L}$ ; 0.1 $\text{g}/\text{L}$
	Accuracy (@25°C/77°F)	$\pm 1\%$ of reading ( $\pm 0.03 \text{ ppm}$ or 1 digit, whichever is greater)
	Calibration	through EC calibration
	TDS Factor	0.40 to 0.80 (default value is 0.50)
Salinity†	Range	0.0 to 400.0 % NaCl; 2.00 to 42.00 PSU; 0.0 to 80.0 $\text{g}/\text{L}$
	Resolution	0.1 % NaCl; 0.01 PSU; 0.01 $\text{g}/\text{L}$
	Accuracy (@25°C/77°F)	$\pm 1\%$ of reading
	Calibration	PSU and $\text{g}/\text{L}$ through EC calibration; % NaCl – one-point with HI7037 sea water standard
Temperature	Range*	-20.0 to 120.0°C; -4.0 to 248.0°F
	Resolution	0.1°C; 0.1°F
	Accuracy	$\pm 0.5^\circ\text{C}$ ; $\pm 0.9^\circ\text{F}$
Additional Specifications	Probe	HI763100 digital four-ring conductivity probe with 3.5 mm (1/8") connector and 1 m (3.3') cable
	Logging	up to 1000† (400 for basic mode) records organized in: manual log-on-demand (max. 200 logs), manual log-on-stability (max. 200 logs), interval logging† (max. 600 samples; 100 lots)
	Connectivity	1 USB port for storage; 1 micro USB port for charging and PC connectivity
	Environment	0 to 50°C (32 to 122°F); RH max 95% non-condensing
	Power Supply	5 VDC adapter (included)
	Dimensions	202 x 140 x 12 mm (7.9" x 5.5" x 0.5")
	Weight	250 g (8.82 oz.)
Ordering Information	<p><b>HI2003-01</b> (115V) and <b>HI2003-02</b> (230V) edge EC includes: HI763100 Conductivity probe, 1413 <math>\mu\text{S}/\text{cm}</math> conductivity standard sachets (4), 12880 <math>\mu\text{S}/\text{cm}</math> conductivity standard sachets (2), 5000 <math>\mu\text{S}/\text{cm}</math> conductivity standard sachets (2), electrode rinse solution sachets (2), benchtop docking station with electrode holder, wall-mount cradle, USB cable, 5 VDC power adapter, quality certificates and instruction manual.</p> <p><b>HI2003-03</b> includes the above without probe.</p>	

\* temperature limits will be reduced to actual probe limits

\*\* with temperature compensation function disabled

† standard mode only

HI98192

## Professional Waterproof Meters

EC/TDS/Resistivity/Salinity Meter with USP <645>

- **Waterproof**
  - IP67 rated waterproof, rugged enclosure
- **Salinity readings**
  - Salinity can be displayed as % NaCl, seawater scale (ppt) or practical salinity scale (PSU)
- **Calibration**
  - Perform up to a five point calibration for enhanced accuracy
- **Temperature compensation**
  - Automatic Temperature Compensation
  - Configurable temperature coefficient range from 0.00 to 10.00%.°C
- **Four-ring stainless steel probe**
  - This probe can cover low EC samples to 1000 mS/cm (actual EC)
- **Clear display**
  - Dot matrix display with multifunction virtual keys
- **AutoHold**
  - Automatically holds the first stable reading on the display
- **Calibration timeout**
  - Alerts when calibration is due at a specified interval
- **Connectivity**
  - PC connectivity via opto-isolated micro-USB with HI92000 software
- **GLP**
  - GLP data provides data from previous calibration to ensure Good Laboratory Practices are met
- **Approximately 100 hour battery life**
  - Powered by (4) 1.5V AA batteries
- **Intuitive keypad**
  - Most of the available options such as GLP information, help, range, calibration and backlight have a dedicated button
- **Supplied complete**
  - Each meter is supplied complete with sensor, calibration solution, beakers, PC software and connection cable, instruction manual, quick start guide and batteries in a rugged, custom carrying case.



### For Universal Applications

HI98192 is a waterproof, portable conductivity meter that has an expanded conductivity range from 0.000  $\mu\text{S}/\text{cm}$  to 400 mS/cm, as well as TDS, resistivity and three salinity scales. This meter offers a quick connect four-ring probe and allows the user to adjust the nominal cell constant. HI98192 is also ready to perform all three stages of USP <645> method required for EC measurement of ultrapure water.



- **Optional shockproof silicon rubber boot**
  - Specially designed to protect your instrument from damage or impact

HI710034 Orange



## Backlit Graphic LCD Display

The HI98192 features a backlit graphic LCD with on-screen help. The graphic display allows for the use of virtual keys to provide for an intuitive user interface.

## Waterproof Protection

The meter is enclosed in an IP67 rated waterproof casing and can withstand immersion in water at a depth of 1 m for up to 30 minutes.



## Quick connect probe

The HI763133 four-ring stainless steel conductivity probe features a quick connect DIN connector to make attaching and removing the probe simple and easy.

## PC Connectivity

Logged data can be transferred to a Windows compatible PC with the included HI920015 micro USB cable and HI92000 software.

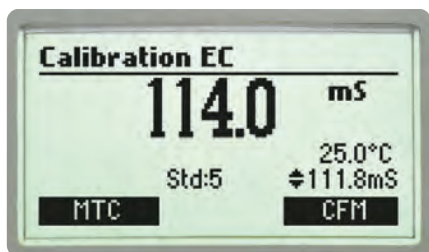

## Calibration

Choose from seven memorized standards and obtain up to a five point conductivity calibration. For salinity (% range), HI7037 standard allows users to perform a one point calibration.

## USP <645>

HI98192 can be used to perform all three stages of USP method required for EC measurement of ultrapure water and generates a report when the any of the three stages are met.

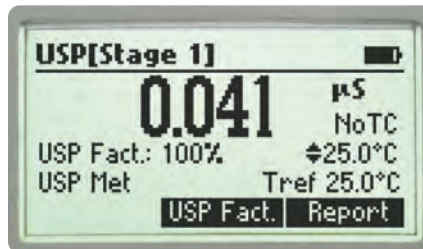

- Three stages of conformity
  - Performs all 3 stages of USP <645> water quality testing requirements

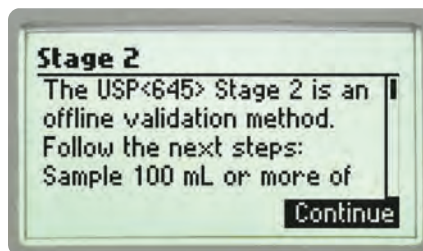

- On-screen guide
  - Users are provided with on-screen instructions for each USP stage

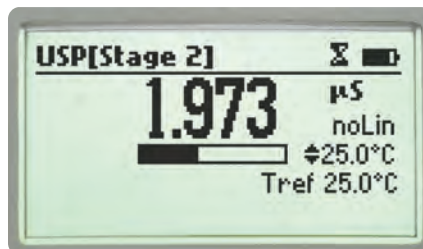

- Progress bar
  - Displays reading stability progress towards meeting stage 2 requirements

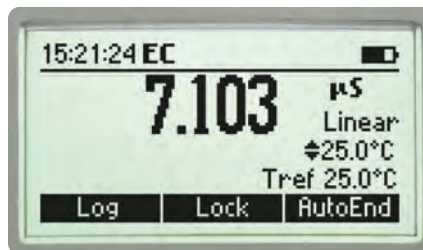

## Measurement

EC and TDS measurements are fully customizable and include: cell constant selection between 0.010 and 10.000, selection of linear or natural water (non-linear) or no temperature compensation (for actual conductivity reading), configurable temperature compensation coefficient range

from 0.00 to 10.00%/°C, choice of reference temperatures of 15°C, 20°C and 25°C, and a selectable TDS factor between 0.40 and 1.00.

Ten sets of customized measurement parameters can be stored as a user profile and later recalled.



## Data Logging

The HI98192's allows storage of up to 400 log-on-demand samples or 1000 lot logging samples that can be later transferred to a PC with the supplied HI920015 USB cable and HI92000 software.

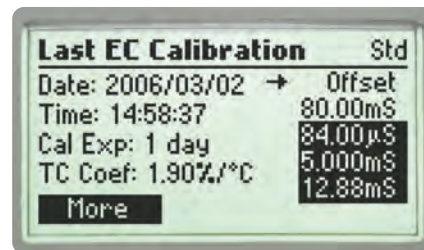

## GLP

Comprehensive GLP functions are directly accessible by pressing the GLP key. Calibration data, including date, time and calibration values are stored for retrieval at a later time



## AutoHold

Pressing AutoHold during measurement will automatically hold the first stable reading on the display.

## Dedicated Help Key

Contextual help is always available through a dedicated "HELP" key. Clear tutorial messages and directions are available on-screen to quickly and easily guide users through setup and calibration. The help information displayed is relative to the setting/option being viewed.

## Rugged custom carrying case

The HI98192 meter, probe, and all accessories are supplied in the HI720192 rugged carrying case designed to provide years of use. The inside compartment of the carrying case is thermoformed to securely hold and protect all of the components.



Specifications	HI98192	
EC	Range	0 to 400 mS/cm (shows values up to 1000 mS/cm actual conductivity)** 0.001 to 9.999 $\mu$ S/cm*; 10.00 to 99.99 $\mu$ S/cm; 100.0 to 999.9 $\mu$ S/cm; 1.000 to 9.999 mS/cm; 10.00 to 99.99 mS/cm; 100.0 to 1000.0 mS/cm (autoranging)
	Resolution	0.001 $\mu$ S/cm*; 0.01 $\mu$ S/cm; 0.1 $\mu$ S/cm; 0.001 mS/cm; 0.01 mS/cm; 0.1 mS/cm
	Accuracy	$\pm$ 1% of reading ( $\pm$ 0.01 $\mu$ S/cm or 1 digit, whichever is greater)
	Calibration	automatic up to five points with seven memorized standards (0.00 $\mu$ S/cm, 84.0 $\mu$ S/cm, 1.413 mS/cm, 5.00 mS/cm, 12.88 mS/cm, 80.0 mS/cm, 111.8 mS/cm)
TDS	Range	0.00 to 99.99 ppm; 100.0 to 999.9 ppm; 1.000 to 9.999 g/L; 10.00 to 99.99 g/L; 100.0 to 400.0 g/L (autoranging)
	Resolution	0.01 ppm; 0.1 ppm; 0.001 g/L; 0.01 g/L; 0.1 g/L
	Accuracy	$\pm$ 1% of reading ( $\pm$ 0.05 ppm or 1 digit, whichever is greater)
Resistivity	Range	1.0 to 99.9 $\Omega$ •cm; 100 to 999 $\Omega$ •cm; 1.00 to 9.99 K $\Omega$ •cm; 10.0 to 99.9 K $\Omega$ •cm; 100 to 999 K $\Omega$ •cm; 1.00 to 9.99 M $\Omega$ •cm; 10.0 to 100.0 M $\Omega$ •cm* (autoranging)
	Resolution	0.1 $\Omega$ •cm; 1 $\Omega$ •cm; 0.01 K $\Omega$ •cm; 0.1 K $\Omega$ •cm; 1 K $\Omega$ •cm; 0.01 M $\Omega$ •cm; 0.1 M $\Omega$ •cm*
	Accuracy	$\pm$ 1% of reading ( $\pm$ 10 $\Omega$ or 1 digit, whichever is greater)
Salinity	Range	% NaCl: 0.0 to 400.0%; practical salinity: 0.00 to 42.00 (PSU); seawater scale: 0.00 to 80.00 (ppt)
	Resolution	0.1%; 0.01
	Accuracy	$\pm$ 1% of reading
	Calibration	max. one point only in % NaCl range with HI7037 standard; use conductivity calibration for all other ranges
Temperature <sup>†</sup>	Range	-20.0 to 120.0°C; -4.0 to 248.0°F
	Resolution	0.1°C; 0.1°F
	Accuracy	$\pm$ 0.2°C; $\pm$ 0.4°F (excluding probe error)
	Calibration	one or two points
Additional Specifications	Cell Constant Setup	0.010 to 10.000
	Temperature Compensation	NoTC, linear (-20.0 to 120.0°C (-4.0 to 248.0°F)), non linear (0 to 36°C (32 to 98.6°F)) ISO/DIS 7888 std
	Reference Temperature	15°C, 20°C and 25°C
	Temperature Coefficient	0.00 to 10.00 %/°C
	TDS Factor	0.40 to 1.00
	Probe	HI763133 stainless steel, four-ring conductivity/TDS probe with internal temperature sensor and 1.5 m (4.9') cable (included)
	Logging	log-on-demand: 400 samples; lot logging: 5, 10, 30 sec, 1, 2, 5, 10, 15, 30, 60, 120, 180 min (max 1000 samples)
	Memorized Profiles	up to 10
	Measurement Modes	autorange, autoend, lock and fixed range
	PC Connectivity	opto-isolated sealed USB (with HI92000 software and micro USB cable)
	Battery Type / Life	1.5V AA batteries (4) / approximately 100 hours of continuous use (without backlight), 25 hours with backlight;
	Auto-off	user selectable: 5, 10, 30, 60 min, disabled
	Environment	0 to 50°C (32 to 122°F); RH 100% IP67
	Dimensions/Weight	185 x 93 x 35.2 mm (7.3 x 3.6 x 1.4") / 400 g (14.2 oz.)
Ordering Information	<b>HI98192</b> is supplied with HI763133 stainless steel, four-ring conductivity/TDS probe, HI7031M 1413 $\mu$ S/cm calibration solution (230 mL), HI7035M 111.8 mS/cm calibration solution (230 mL), 100 mL plastic beaker (2), HI92000 PC software, HI920015 micro USB cable, 1.5V AA batteries (4), quick start guide, quality certificate and instruction manual in an HI720192 rugged carrying case with custom insert.	
Accessories	<b>HI710034</b> orange protective rubber boot	

\* The 0.001  $\mu$ S/cm EC range and 0.1 M $\Omega$ •cm Resistivity range are not available with the 1.5 m cable probe  
 \*\*Uncompensated temperature reading  
 (†) Reduced to actual sensor limits





## For Ultrapure Water Applications

HI98197 is a waterproof, portable EC (conductivity) meter that has an expanded conductivity range from 0.000  $\mu\text{S}/\text{cm}$  to 400  $\text{mS}/\text{cm}$ , as well as TDS (total dissolved solids), resistivity, and three salinity scales. This meter offers a quick connect four-ring platinum probe and allows the user to adjust the nominal cell constant. HI98197 is also ready to perform all three stages of USP <645> method required for EC measurement of water for injection.

- **Optional shockproof silicon rubber boot**
  - Specially designed to protect your instrument from damage or impact

HI710034 Orange

HI98197

# Professional Waterproof Meter

for Ultrapure Water

- **Waterproof**
  - IP67 rated waterproof, rugged enclosure
- **Conductivity and resistivity**
  - High resolution of 0.001  $\mu\text{S}/\text{cm}$  for conductivity and 0.1  $\text{M}\Omega\cdot\text{cm}$  for resistivity
- **Calibration**
  - Perform up to a five point calibration for enhanced accuracy
- **Temperature compensation**
  - Automatic Temperature Compensation
  - Configurable temperature coefficient range from 0.00 to 10.00%/°C
- **Four-ring platinum probe**
  - This probe can cover low EC samples to 1000  $\text{mS}/\text{cm}$  (actual EC)
- **Approximately 100 hour battery life**
  - Powered by (4) 1.5V AA batteries
- **Clear display**
  - Graphic LCD display with multifunction virtual keys
- **AutoHold**
  - Automatically holds the first stable reading on the display
- **Enhanced calibration**
  - An "out of calibration range" warning blinks if the measurement range is not covered by the current calibration
- **Calibration timeout**
  - Alerts when calibration is due at a specified interval
- **Connectivity**
  - PC connectivity via opto-isolated micro-USB with HI92000 software
- **Data logging**
  - The HI98197 allows storage of up to 400 log-on-demand samples or 1000 lot logging samples that can be later transferred to a PC with the supplied USB cable and software
- **GLP**
  - GLP data provides information from previous calibration to ensure Good Laboratory Practices are met
- **Intuitive keypad**
  - Most of the available options such as GLP information, help, range, calibration, and backlight have a dedicated button



### Backlit Graphic LCD Display

The HI98197 features a backlit graphic LCD with on-screen help. The graphic display allows for the use of virtual keys to provide for an intuitive user interface.

### Waterproof Protection

The meter is enclosed in an IP67 rated waterproof casing and can withstand immersion in water at a depth of 1 m for up to 30 minutes.



### Quick connect probe

The HI763123 four-ring platinum conductivity probe with a threaded connection features a quick connect DIN connector to make attaching and removing the probe simple and easy.

### Calibration

Choose from seven memorized standards and obtain up to a five point conductivity calibration. For salinity (% range), HI7037 standard allows users to perform a one point calibration.

### Measurement

EC and TDS measurements are fully customizable and include: cell constant selection between 0.010 and 10.000, selection of linear or natural water (non-linear) or no temperature compensation (for actual conductivity reading), configurable temperature compensation coefficient range from 0.00 to 10.00%/°C, choice of reference temperatures of 15°C, 20°C and 25°C, and a selectable TDS factor between 0.40 and 1.00.

Ten sets of customized measurement parameters can be stored as a user profile and later recalled.

### USP <645>

HI98197 can be used to perform all three stages of USP <645> method required for EC measurement of water for injection and generates a report when the any of the three stages are met.

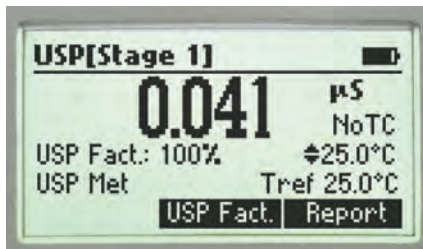

- Three stages of conformity
  - Performs all 3 stages of USP <645> water quality testing requirements

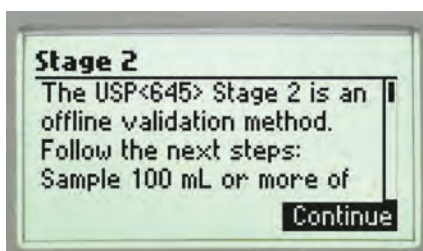

- On-screen guide
  - Users are provided with on-screen instructions for each USP stage



- Progress bar
  - Displays reading stability progress towards meeting stage 2 requirements



### Data Logging

The HI98197's allows storage of up to 400 log-on-demand samples or 1000 lot logging samples that can be later transferred to a PC with the supplied HI920015 USB cable and HI92000 software.

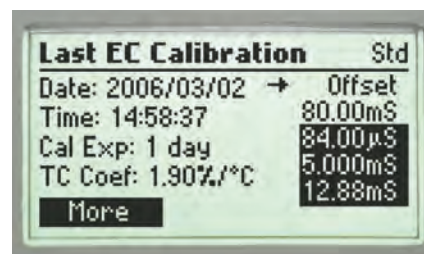

### GLP

Comprehensive GLP functions are directly accessible by pressing the GLP key. Calibration data, including date, time and calibration values are stored for retrieval at a later time

### Intuitive Keypad

The fitted rubber keypad has dedicated keys for power, backlight, up/down arrows, help and alphanumeric characters. The meter also features two virtual soft keys that navigate the user through the configuration of each parameter, meter setup, and logging of data. The interface is intuitive for any user's level of experience.

### AutoHold

Pressing AutoHold during measurement will automatically hold the first stable reading on the display.

### Dedicated Help Key

Contextual help is always available through a dedicated "HELP" key. Clear tutorial messages and directions are available on-screen to quickly and easily guide users through setup and calibration. The help information displayed is relative to the setting/option being viewed.

### Setup screen

Our extensive setup screen features a host of configurable options such as time, date, temperature units and language for help screens and guides

### PC Connectivity

Logged data can be transferred to a Windows compatible PC with the included HI920015 micro USB cable and HI92000 software.

### Long Battery Life

The display of the meter has a battery icon indicator to show the remaining power. The meter uses four 1.5V AA batteries that provide up to 200 hours of battery life.

## Designed for Water Professionals

High purity water used in power generation, semiconductor manufacturing, and other industries can be difficult to measure due to the ability of carbon dioxide ( $\text{CO}_2$ ) to diffuse into water and form carbonic acid ( $\text{H}_2\text{CO}_3$ ). Carbonic acid quickly dissociates into hydrogen ions ( $\text{H}^+$ ) and bicarbonate ions ( $\text{HCO}_3^-$ ). These ions will increase the conductivity and decrease the resistivity of the water. In order to measure high purity water accurately it is necessary to perform a continuous flow measurement. HI98197 uses the HI763123 platinum, four-ring probe with a threaded connection that is screwed into a stainless steel body flow cell. The flow cell is then connected to a water source to more accurately determine the conductivity or resistivity without exposure to air. HI98197 is an ideal meter for monitoring the efficiency of a mixed bed resin or equivalent system that produces high purity water of  $18.2 \text{ M}\Omega \cdot \text{cm}$  at  $25^\circ\text{C}$ .



HI605453 flow cell  
for ultrapure water





## Supplied complete

HI98197 is supplied complete with sensor, flow cell, tubing, calibration solution, beakers, PC software and connection cable, instruction manual, quick start guide and batteries in the HI720197 rugged, custom carrying case.

Specifications	HI98197	
EC	Range	0.000 to 9.999 $\mu\text{S}/\text{cm}$ ; 10.00 to 99.99 $\mu\text{S}/\text{cm}$ ; 100.0 to 999.9 $\mu\text{S}/\text{cm}$ ; 1.000 to 9.999 $\text{mS}/\text{cm}$ ; 10.00 to 99.99 $\text{mS}/\text{cm}$ ; 100.0 to 1000.0 $\text{mS}/\text{cm}$ (actual conductivity*; temperature compensated to 400 $\text{mS}/\text{cm}$ )
	Resolution	0.001 $\mu\text{S}/\text{cm}$ ; 0.01 $\mu\text{S}/\text{cm}$ ; 0.1 $\mu\text{S}/\text{cm}$ ; 0.001 $\text{mS}/\text{cm}$ ; 0.01 $\text{mS}/\text{cm}$ ; 0.1 $\text{mS}/\text{cm}$
	Accuracy	$\pm 1\%$ of reading ( $\pm 0.01 \mu\text{S}/\text{cm}$ or 1 digit, whichever is greater)
	Calibration	automatic up to five points with seven memorized standards (0.00 $\mu\text{S}/\text{cm}$ , 84.0 $\mu\text{S}/\text{cm}$ , 1.413 $\text{mS}/\text{cm}$ , 5.00 $\text{mS}/\text{cm}$ , 12.88 $\text{mS}/\text{cm}$ , 80.0 $\text{mS}/\text{cm}$ , 111.8 $\text{mS}/\text{cm}$ )
TDS	Range	0.00 to 99.99 ppm; 100.0 to 999.9 ppm; 1.000 to 9.999 g/L; 10.00 to 99.99 g/L; 100.0 to 400.0 g/L (autoranging)
	Resolution	0.01 ppm; 0.1 ppm; 0.001 g/L; 0.01 g/L; 0.1 g/L
	Accuracy	$\pm 1\%$ of reading ( $\pm 0.05 \text{ ppm}$ or 1 digit, whichever is greater)
Resistivity	Range	1.0 to 99.9 $\Omega \cdot \text{cm}$ ; 100 to 999 $\Omega \cdot \text{cm}$ ; 1.00 to 9.99 $\text{K}\Omega \cdot \text{cm}$ ; 10.0 to 99.9 $\text{K}\Omega \cdot \text{cm}$ ; 100 to 999 $\text{K}\Omega \cdot \text{cm}$ ; 1.00 to 9.99 $\text{M}\Omega \cdot \text{cm}$ ; 10.0 to 100.0 $\text{M}\Omega \cdot \text{cm}$ (autoranging)
	Resolution	0.1 $\Omega \cdot \text{cm}$ ; 1 $\Omega \cdot \text{cm}$ ; 0.01 $\text{K}\Omega \cdot \text{cm}$ ; 0.1 $\text{K}\Omega \cdot \text{cm}$ ; 1 $\text{K}\Omega \cdot \text{cm}$ ; 0.01 $\text{M}\Omega \cdot \text{cm}$ ; 0.1 $\text{M}\Omega \cdot \text{cm}$
	Accuracy	$\pm 1\%$ of reading ( $\pm 10 \Omega$ or 1 digit, whichever is greater)
Salinity	Range	% NaCl: 0.0 to 400.0%; practical salinity: 0.00 to 42.00 (PSU); seawater scale: 0.00 to 80.00 (ppt)
	Resolution	0.1%; 0.01
	Accuracy	$\pm 1\%$ of reading
	Calibration	max. one point only in % NaCl range with HI7037 standard; use conductivity calibration for all other ranges
Temperature <sup>†</sup>	Range	-20.0 to 120.0°C; -4.0 to 248.0°F
	Resolution	0.1°C; 0.1°F
	Accuracy	$\pm 0.2^\circ\text{C}$ ; $\pm 0.4^\circ\text{F}$ (excluding probe error)
	Calibration	one or two points
Additional Specifications	Cell Constant Setup	0.010 to 10.000
	Temperature Compensation	NoTC, linear (-20.0 to 120.0°C; -4.0 to 248.0°F), non linear (0 to 36°C; 32 to 98.6°F) ISO/DIS 7888 std
	Reference Temperature	15°C, 20°C, and 25°C
	Temperature Coefficient	0.00 to 10.00 %/°C
	TDS Factor	0.40 to 1.00
	Probe	HI763123 platinum, four-ring conductivity/TDS probe with internal temperature sensor and 1 m (3.3') cable (included)
	Logging	log-on-demand: 400 samples; lot logging: 5, 10, 30 sec, 1, 2, 5, 10, 15, 30, 60, 120, 180 min (max 1000 samples)
	Memorized Profiles	up to 10
	Measurement Modes	autorange, autoend, lock, and fixed range
	PC Connectivity	opto-isolated sealed USB (with HI92000 software and micro USB cable)
	Battery Type / Life	1.5V AA batteries (4) / approximately 100 hours of continuous use (without backlight), 25 hours with backlight
	Auto-off	user selectable: 5, 10, 30, 60 min, disabled
	Environment	0 to 50°C (32 to 122°F); RH 100% IP67
	Dimensions/Weight	185 x 93 x 35.2 mm (7.3 x 3.6 x 1.4") / 400 g (14.2 oz.)
	Ordering Information	<b>HI98197</b> is supplied with HI763123 platinum, four-ring conductivity/TDS probe with internal temperature sensor and 1 m (3.3') cable, HI605453 stainless steel flow cell for ultrapure water, tubing, HI7031M 1413 $\mu\text{S}/\text{cm}$ calibration solution (230 mL), HI7033M 84 $\mu\text{S}/\text{cm}$ calibration solution (230 mL), 100 mL plastic beaker (2), HI92000 PC software, HI920015 micro USB cable, 1.5V batteries (4), quality certificate, instruction manual and quick start guide in an HI720197 rugged carrying case with custom insert.
Accessories	<b>HI710034</b> orange protective rubber boot	

\*Uncompensated temperature reading  
 (†) Reduced to actual sensor limits



HI99300 · HI99301

## Portable EC Meters

EC/TDS and Temperature

- Simultaneous EC/TDS and temperature measurements on a large dual-line LCD display
- User-friendly Design
  - With only two buttons, meter operation could not be simpler. Two buttons allow you to quickly adjust settings, select the measurement range, and choose calibration buffer sets.
- Durable IP67 waterproof casing
  - Designed to withstand the knocks, drops, and spills of real life, the new IP67 body ensures top performance in any environment. These meters are totally protected against dust and water intrusion from any direction.
- Watertight Connection
  - A Quick Connect DIN connector makes attaching and removing the probe simple and easy. The rubber coating protects the cable and creates a sealed connection for added reliability.

- HOLD button
  - Freezes the reading on the display
- Selectable temperature unit (°C or °F)
- Battery life indication and low battery detection

HI99300 and HI99301 are conductivity, total dissolved solids and temperature meters designed to meet the requirements encountered in manufacturing and environmental testing protocols.

To increase precision, these models feature a different conductivity range, to cover applications from purified to brackish waters.

The supplied multi-parameter probe includes EC/TDS and temperature in one convenient, rugged probe.

Other user selectable features include different TDS factors from 0.45 to 1.00, and a range of temperature coefficients ( $\beta$ ) from 0.0 to 2.4% for better solution temperature compensation.

- Optional shockproof silicon rubber boot
  - Specially designed to protect your instrument from damage or impact



HI710028 Orange  
HI710029 Blue  
HI710030 Green

Specifications	HI99300	HI99301	
EC	Range	0 to 3999 $\mu\text{S}/\text{cm}^*$	0.00 to 20.00 $\text{mS}/\text{cm}^*$
	Resolution	1 $\mu\text{S}/\text{cm}$	0.01 $\text{mS}/\text{cm}$
	Accuracy (@25°C/77°F)	$\pm 2\%$ F.S.	$\pm 2\%$ F.S.
TDS	Range	0 to 2000 ppm (mg/L)	0.00 to 10.00 ppt (g/L)
	Resolution	1 ppm (mg/L)	0.01 ppt (g/L)
	Accuracy (@25°C/77°F)	$\pm 2\%$ F.S.	$\pm 2\%$ F.S.
Temperature	Range	0.0 to 60.0°C/32.0 to 140.0°F	0.0 to 60.0°C/32.0 to 140.0°F
	Resolution	0.1°C/0.1°F	0.1°C/0.1°F
	Accuracy (@25°C/77°F)	$\pm 0.5^\circ\text{C}/\pm 1.0^\circ\text{F}$	$\pm 0.5^\circ\text{C}/\pm 1.0^\circ\text{F}$
Additional Specifications	Calibration	automatic, one point at 1413 $\mu\text{S}/\text{cm}$ or 1382 ppm (CONV 0.5) or 1500 ppm (CONV 0.7)	automatic, one point at 12.88 $\text{mS}/\text{cm}$ or 6.44 ppt (CONV 0.5) or 9.02 ppt (CONV 0.7)
	EC/TDS Temperature Compensation	automatic, with $\beta$ selectable from 0.0 to 2.4% / °C with 0.1 increments	
	TDS conversion factor	Selectable from 0.45 to 1.00 with 0.01 increments	
	Probe (included)	HI763063 EC/TDS/temperature sensor, DIN connector and 1 m (3.3') cable	
	Battery Type / Life	1.5V AAA (3) / approx. 500 hours of continuous use	
	Auto-Off	user selectable: after 8 min, 60 min or disabled	
	Environment	0 to 50°C (32 to 122°F); RH max. 100%	
	Meter Dimensions	154 x 63 x 30 mm (6.1 x 2.5 x 1.2")	
	Meter Mass (with batteries)	196 g (6.91 oz.)	
	Case Ingress Protection Rating	IP67	
Ordering Information	<p><b>HI99300</b> is supplied with HI763063 pH/EC/TDS probe with built-in temperature sensor, DIN connector and 1m (3.3') cable, HI70031 1413 <math>\mu\text{S}/\text{cm}</math> and HI70032 1382 ppm calibration solution sachets, 100 mL beaker, 1.5V AAA batteries (3), calibration certificate of meter, calibration certificate of probe, instruction manual and HI710142 rugged carrying case.</p> <p><b>HI99301</b> is supplied with HI763063 pH/EC/TDS probe with built-in temperature sensor, DIN connector and 1m (3.3') cable, HI70030 12880 <math>\mu\text{S}/\text{cm}</math> and HI70038 6.44 ppt calibration solution sachets, 100 mL beaker, 1.5V AAA batteries (3), calibration certificate of meter, calibration certificate of probe, instruction manual and HI710142 rugged carrying case.</p>		

\* displays  $\mu\text{S}$  for  $\mu\text{S}/\text{cm}$ .  
\* displays  $\text{mS}$  for  $\text{mS}/\text{cm}$ .

HI8733

## Multi-range EC Meters

- Automatic temperature compensation (ATC)
- Help feature
  - On-screen user guides
- One-point calibration
  - One-point calibration
- Waterproof

The HI8733 conductivity meter has been designed for use in areas of production and quality control.

This meter utilize a four ring potentiometric probe that offers greater versatility over typical amperometric designs. This rugged probe is made of PVC and is ideal for indoor as well as outdoor measurements.

HI8733's conductivity measurements can be automatically temperature compensated by using the HI76302W probe with built-in temperature sensor.



### Specifications HI8733

Range	0.0 to 199.9 $\mu\text{S}/\text{cm}$ ; 0 to 1999 $\mu\text{S}/\text{cm}$ 0.00 to 19.99 $\text{mS}/\text{cm}$ ; 0.0 to 199.9 $\text{mS}/\text{cm}$
Resolution	0.1 $\mu\text{S}/\text{cm}$ ; 1 $\mu\text{S}/\text{cm}$ 0.01 $\text{mS}/\text{cm}$ ; 0.1 $\text{mS}/\text{cm}$
Accuracy (@25°C/77°F)	$\pm 1\%$ F.S. (excluding probe error)
Calibration	manual, one-point through EC knob
Temperature Compensation	automatic, 0 to 50°C (32 to 122°F) with $\beta$ adjustable from 0 to 2.5%/°C
Probe	HI76302W four-ring conductivity probe with internal temperature sensor, DIN connector and 1 m (3.3') cable (included)
Battery Type / Life	9V / approximately 100 hours of continuous use
Environment	0 to 50°C (32 to 122°F); RH max 100%
Dimensions	145 x 80 x 36 mm (5.7 x 3.1 x 1.4")
Weight	230 g (8.1 oz.)
Ordering Information	<b>HI8733</b> is supplied with HI76302W conductivity probe, 12880 $\mu\text{S}/\text{cm}$ HI70030 calibration solution sachet, battery, instructions and rugged carrying case.
Accessories	<b>HI710007</b> blue shockproof rubber boot <b>HI710008</b> orange shockproof rubber boot



HI8734

## TDS Meter

- One-point calibration
- Waterproof

The HI8734 has not only been specifically designed for the water conditioning industry, but particularly in the softening, demineralization, reverse osmosis and drinking water applications.

Three ranges of measurement ensure the highest accuracy possible. All three ranges can be executed at the touch of a button, without having to change the conductivity probe. This makes it very easy to switch applications without having to worry about recalibration.

To enhance accuracy and efficiency, MTC (Manual Temperature Compensation) is available using a knob on the front panel.

For the best protection in the field, the four-ring potentiometric probe is made of rugged PVC. To access difficult areas, the probe is supplied with a 1 m (3.3') cable.

The ratio between conductivity and TDS is factory set at 0.5.

Specifications	HI8734
Range	0.0 to 199.9 mg/L (ppm); 0 to 1999 mg/L (ppm); 0.00 to 19.99 g/L (ppt)
Resolution	0.1 mg/L (ppm); 1 mg/L (ppm); 0.01 g/L (ppt)
Accuracy (@25°C/77°F)	±1% F.S. (excluding probe error)
Calibration	manual, one-point through TDS knob
Temperature Compensation	manual from 0 to 50°C (32 to 122°F) with $\beta = 2\%/^{\circ}\text{C}$
TDS Factor	0.5
Probe	HI76301D four ring conductivity probe with DIN connector and 1 m (3.3') cable (included)
Battery Type / Life	9V / approximately 100 hours of continuous use
Environment	0 to 50°C (32 to 122°F); RH max 100%
Dimensions	145 x 80 x 36 mm (5.7 x 3.1 x 1.4")
Weight	230 g (8.1 oz.)
Ordering Information	<b>HI8734</b> is supplied with HI76301D conductivity probe, HI70032 1382 mg/L (ppm) calibration solution sachet, battery, instructions and rugged carrying case.
Accessories	<b>HI710007</b> blue shockproof rubber boot <b>HI710008</b> orange shockproof rubber boot

# EC Calibration Solutions

Quality Solutions for Laboratory Applications

- **Safety Data Sheets**
  - Safety data sheets for all Hanna solutions are available at [hannainst.com](http://hannainst.com) or upon request.
- **Expiration date**
  - The production batch number, expiration date, and temperature correlation table are reported on all Hanna calibration solutions.
- **NIST traceability**
  - Standardized using a conductivity meter and probe calibrated against NIST primary standard solutions or primary standard solutions prepared following NIST guidelines.
- **Air-tight bottles**
  - Air tight bottle with tamper-proof seal of freshness to ensure quality.
- **FDA compliant bottles (HI80xx)**
  - Hanna solutions are offered in opaque, light-tight bottles that meet FDA requirements.
- **High Accuracy Solutions (HI60xx)**
  - HI60xx high accuracy solutions are also available and are supplied with a certificate of analysis.



## 84 µS/cm Calibration Solution

This 84 µS/cm conductivity solution makes it possible to calibrate instruments with a conductivity scale of up to 200 µS/cm, in the measurement of pure or distilled water.

## 84 µS/cm Bottles

Code	EC Value @25°C	Size	Package	FDA Bottle	Certificate of Analysis
HI6033	84 µS/cm	500 mL	1 bottle		•
HI7033/1L	84 µS/cm	1 L	1 bottle		
HI7033L	84 µS/cm	500 mL	1 bottle		
HI7033M	84 µS/cm	230 mL	1 bottle		
HI5033-12	84 µS/cm	120 mL	1 bottle		
HI8033L	84 µS/cm	500 mL	1 bottle	•	•



# EC Calibration Solutions

Quality Solutions for Laboratory Applications



- **Safety Data Sheets**
  - Safety data sheets for all Hanna solutions are available at [hannainst.com](http://hannainst.com) or upon request.
- **Expiration date**
  - The production batch number, expiration date, and temperature correlation table are reported on all Hanna calibration solutions.
- **NIST traceability**
  - Standardized using a conductivity meter and probe calibrated against NIST primary standard solutions or primary standard solutions prepared following NIST guidelines.
- **Air-tight bottles**
  - Air tight bottle with tamper-proof seal of freshness to ensure quality.
- **Single use sachets**
  - Light block packaging prevents oxidation from UV light that could alter the value. Every sachet is as fresh as the day it was packaged.
- **FDA compliant bottles (HI80xx)**
  - Hanna solutions are offered in opaque, light-tight bottles that meet FDA requirements.
- **High Accuracy Solutions (HI60xx)**
  - HI60xx high accuracy solutions are also available and are supplied with a certificate of analysis.

## 1413 µS/cm Calibration Solution

The 1413 µS/cm calibration solution is best suited for general use. This solution is also available in combined sachet kits with Hanna pH 7 buffer for easy calibration of multiparameter instruments.



## 1413 µS/cm Bottles

Code	EC Value @25°C	Size	Package	FDA Bottle	Certificate of Analysis
HI6031	1413 µS/cm	500 mL	1 bottle		•
HI7031/1G	1413 µS/cm	1 G (3.78 L)	1 bottle		
HI7031/1L	1413 µS/cm	1 L	1 bottle		
HI7031L	1413 µS/cm	500 mL	1 bottle		
HI7031L/C	1413 µS/cm	500 mL	1 bottle		•
HI7031M	1413 µS/cm	230 mL	1 bottle		
HI5031-12	1413 µS/cm	120 mL	1 bottle		
HI7031-023	1.41 mS/cm	230 mL (GroLine®)	1 bottle		•
HI7031-012	1.41 mS/cm	120 mL (GroLine)	1 bottle		•
HI8031L	1413 µS/cm	500 mL	1 bottle	•	•

## 1413 µS/cm Sachets

Code	EC Value @25°C	Size	Package	Certificate of Analysis
HI70031C	1413 µS/cm	20 mL	25 sachets	•
HI70031G	1.41 mS/cm	20 mL (GroLine)	25 sachets	•
HI70031P	1413 µS/cm	20 mL	25 sachets	
HI77100C	1413 µS/cm & pH 7.01	20 mL	20 sachets (10 ea)	•
HI77100P	1413 µS/cm & pH 7.01	20 mL	20 sachets (10 ea)	

# EC Calibration Solutions

Quality Solutions for Laboratory Applications

- **Safety Data Sheets**
  - Safety data sheets for all Hanna solutions are available at [hannainst.com](http://hannainst.com) or upon request.
- **Expiration date**
  - The production batch number, expiration date, and temperature correlation table are reported on all Hanna calibration solutions.
- **NIST traceability**
  - Standardized using a conductivity meter and probe calibrated against NIST primary standard solutions or primary standard solutions prepared following NIST guidelines.
- **Air-tight bottles**
  - Air tight bottle with tamper-proof seal of freshness to ensure quality.
- **Single use sachets**
  - Light block packaging prevents oxidation from UV light that could alter the value. Every sachet is as fresh as the day it was packaged.
- **FDA compliant bottles (HI80xx)**
  - Hanna solutions are offered in opaque, light-tight bottles that meet FDA requirements.



## 5000 µS/cm Bottles

Code	EC Value @25°C	Size	Package	FDA Bottle	Certificate of Analysis
HI7039/1L	5000 µS/cm	1 L	1 bottle		
HI7039L	5000 µS/cm	500 mL	1 bottle		
HI7039M	5000 µS/cm	250 mL	1 bottle		
HI7039-023	5000 µS/cm	230 mL (GroLine®)	1 bottle		•
HI7039-012	5000 µS/cm	120 mL (GroLine)	1 bottle		•
HI8039L	5000 µS/cm	500 mL	1 bottle	•	•

## 5000 µS/cm Calibration Solution

This calibration solution is ideal for applications that need to achieve higher reading accuracies in a conductivity scale between 2,000 µS/cm and 10,000 µS/cm. This solution is widely used in agriculture for monitoring and preparing nutrient solutions for proper crop production.



## 5000 µS/cm Sachets

Code	EC Value @25°C	Size	Package	Certificate of Analysis
HI70039C	5000 µS/cm	20 mL	25 sachets	•
HI70039G	5000 µS/cm	20 mL (GroLine)	25 sachets	•
HI70039P	5000 µS/cm	20 mL	25 sachets	

# EC Calibration Solutions

Quality Solutions for Laboratory Applications

- **Safety Data Sheets**
  - Safety data sheets for all Hanna solutions are available at [hannainst.com](http://hannainst.com) or upon request.
- **Expiration date**
  - The production batch number, expiration date, and temperature correlation table are reported on all Hanna calibration solutions.
- **NIST traceability**
  - Standardized using a conductivity meter and probe calibrated against NIST primary standard solutions or primary standard solutions prepared following NIST guidelines.
- **Air-tight bottles**
  - Air tight bottle with tamper-proof seal of freshness to ensure quality.
- **Single use sachets**
  - Light block packaging prevents oxidation from UV light that could alter the value. Every sachet is as fresh as the day it was packaged.
- **FDA compliant bottles (HI80xx)**
  - Hanna solutions are offered in opaque, light-tight bottles that meet FDA requirements.



## 12880 µS/cm Bottles

Code	EC Value @25°C	Size	Package	FDA Bottle	Certificate of Analysis
HI7030/1G	12880 µS/cm	1 G (3.78 L)	1 bottle		
HI7030/1L	12880 µS/cm	1 L	1 bottle		
HI7030L	12880 µS/cm	500 mL	1 bottle		
HI7030L/C	12880 µS/cm	500 mL	1 bottle		•
HI7030M	12880 µS/cm	250 mL	1 bottle		
HI5030-12	12880 µS/cm	120 mL	1 bottle		
HI8030L	12880 µS/cm	500 mL	1 bottle	•	•

## 12880 µS/cm Calibration Solution

The 12880 µS/cm (12.88 mS/cm) calibration solution is widely used to assure the proper performance of conductivity meters with a scale higher than 10 mS/cm.



## 12880 µS/cm Sachets

Code	EC Value @25°C	Size	Package	Certificate of Analysis
HI70030C	12880 µS/cm	20 mL	25 sachets	•
HI70030P	12880 µS/cm	20 mL	25 sachets	
HI700304P	12880 µS/cm	20 mL (Pool Line)	25 sachets	

# EC Calibration Solutions

Quality Solutions for Laboratory Applications

- **Safety Data Sheets**
  - Safety data sheets for all Hanna solutions are available at [hannainst.com](http://hannainst.com) or upon request.
- **Expiration date**
  - The production batch number, expiration date, and temperature correlation table are reported on all Hanna calibration solutions.
- **NIST traceability**
  - Standardized using a conductivity meter and probe calibrated against NIST primary standard solutions or primary standard solutions prepared following NIST guidelines.
- **Air-tight bottles**
  - Air tight bottle with tamper-proof seal of freshness to ensure quality.
- **FDA compliant bottles (HI80xx)**
  - Hanna solutions are offered in opaque, light-tight bottles that meet FDA requirements.



## 80000 µS/cm Calibration Solution

The 80,000 µS/cm calibration solution is needed for the proper calibration of instrumentation used to measure high conductivity samples such as wastewater, solutions with suspended solids and plating baths.

This calibration solution is also ideal for use in the agroalimentary sector.

## 111800 µS/cm Calibration Solution

This calibration solution is useful to calibrate instrumentation used to measure samples with conductivity higher than 100 mS/cm (100,000 µS/cm).

In fact, this solution makes it possible to calibrate instruments that perform under conditions of high salt concentrations.

This calibration solution is ideal for use in systems where phase limits have to be detected (e.g. separation of a substance from water), monitoring of bottle washing plants, beverage controls, check of acids or bases in electrodeposition processes and some plating baths.

## 80000 µS/cm Bottles

Code	EC Value @25°C	Size	Package	FDA Bottle	Certificate of Analysis
HI7034/1L	80000 µS/cm	1 L	1 bottle		
HI7034L	80000 µS/cm	500 mL	1 bottle		
HI7034M	80000 µS/cm	250 mL	1 bottle		
HI5034-12	80000 µS/cm	120 mL	1 bottle		
HI8034L	80000 µS/cm	500 mL	1 bottle	•	•

## 111800 µS/cm Bottles

Code	EC Value @25°C	Size	Package	FDA Bottle	Certificate of Analysis
HI7035/1L	111800 µS/cm	1 L	1 bottle		
HI7035L	111800 µS/cm	500 mL	1 bottle		
HI7035M	111800 µS/cm	230 mL	1 bottle		
HI8035L	111800 µS/cm	500 mL	1 bottle	•	•



## TDS Calibration Solutions

Quality Solutions for Laboratory Applications

- **Safety data sheets**
  - Safety data sheets for all Hanna solutions are available at [hannainst.com](http://hannainst.com) or upon request.
- **Expiration date**
  - The production batch number, expiration date, and temperature correlation table are reported on all Hanna calibration solutions.
- **NIST traceability**
  - Standardized using a conductivity meter and probe calibrated against NIST primary standard solutions or primary standard solutions prepared following NIST guidelines.
- **Air-tight bottles**
  - Air tight bottle with tamper-proof seal of freshness to ensure quality.
- **Single use sachets**
  - Light block packaging prevents oxidation from UV light that could alter the value. Every sachet is as fresh as the day it was packaged.

### TDS Solutions

Hanna TDS calibration solutions are prepared against a NIST traceable potassium chloride solution.

Hanna TDS solutions have the lot number and expiration date clearly marked on the label and are air tight with a tamper-proof seal to ensure the quality of the solution. Hanna's line of TDS calibration solutions have been specially formulated to have an expiration of 5 years from the date of manufacture for an unopened bottle.



### TDS Bottles

Code	TDS Value @25°C	Size	Package	Certificate of Analysis
HI6032	1382 mg/L (ppm)	500 mL	1 bottle	•
HI7032/1L	1382 mg/L (ppm)	1 L	1 bottle	
HI7032L	1382 mg/L (ppm)	500 mL	1 bottle	
HI7032M	1382 mg/L (ppm)	250 mL	1 bottle	
HI7036/1L	12.41 g/L (ppt)	1 L	1 bottle	
HI7036L	12.41 g/L (ppt)	500 mL	1 bottle	
HI70442/1L*	1500 mg/L (ppm)	500 mL	1 bottle	
HI70442L*	1500 mg/L (ppm)	500 mL	1 bottle	
HI70442M*	1500 mg/L (ppm)	250 mL	1 bottle	

### TDS Sachets

Code	TDS Value @25°C	Size	Package	Certificate of Analysis
HI70032C	1382 mg/L (ppm)	20 mL	25 sachets	•
HI70032P	1382 mg/L (ppm)	20 mL	25 sachets	
HI70038C	6.44 g/L (ppt)	20 mL	25 sachets	•
HI70038P	6.44 g/L (ppt)	20 mL	25 sachets	
HI700384P	6.44 g/L (ppt) (Pool Line)	20 mL	25 sachets	
HI70080C	800 mg/L (ppm)	20 mL	25 sachets	•
HI70080P	800 mg/L (ppm)	20 mL	25 sachets	
HI70442P*	1500 mg/L (ppm)	20 mL	25 sachets	
HI77200P*	1500 mg/L (ppm) & pH 7.01	20 mL	20 sachets (10 ea)	

\* TDS Conversion Factor 4-4-2: 0.65 ppm = 1 µS/cm (approximately).

# GroLine®

## Quick Cal

### pH/EC Quick Cal Calibration Solution

Quick Cal is for use with Hanna's GroLine® pH and/or EC/TDS meters. Using the Quick Cal function found in compatible meters allows for single-point calibration for pH and/or conductivity sensors.

- Calibration solution for Gro line pH and EC/TDS meters
- pH calibration buffer value of pH 6.86
- EC calibration standard value of 5,000  $\mu\text{S/cm}$  (5.00 mS/cm)
- Safety Data Sheets
  - Safety data sheets for all Hanna solutions are available at [hannainst.com](http://hannainst.com) or upon request.
- Expiration date
  - The production batch number, expiration date, and temperature correlation table are reported on all Hanna calibration solutions.
- NIST traceability
  - Standardized using a pH meter calibrated by means of two standard solutions prepared from NIST standard reference materials. A conductivity meter and probe calibrated against NIST primary standard solutions or primary standard solutions prepared following NIST guidelines.



### Quick Cal pH/EC Bottles

- Air-tight bottles
  - Air tight bottle with tamper-proof seal of freshness to ensure quality.

Code	Size	Certificate of Analysis
HI5036-050	500 mL (GroLine)	•
HI5036-023	230 mL (GroLine)	•
HI5036-012	120 mL (GroLine)	•

### Quick Cal pH/EC Sachets

- Single use sachets
  - Light block packaging prevents oxidation from UV light that could alter the value. Every sachet is as fresh as the day it was packaged

Code	Size	Certificate of Analysis
HI50036P	20 mL sachets, 25 pcs. (GroLine)	-

## Seawater Salinity Calibration Solutions

Hanna calibration solutions have the lot number and expiration date clearly marked on the label. All bottles are air tight with a tamper-proof seal to ensure the quality of the solution.

HI7037 is a premium quality calibration solution for seawater salinity according to the 1902 International Council for the Exploration of the Sea (ICES) percent scale.

- Air tight bottle with tamper-proof seal to ensure quality.
- Lot number and expiration date printed on each label.



### Salinity Bottles

Code	Description	Size	Package
HI7037L	100% NaCl	500 mL	1 bottle
HI7037M	100% NaCl	250 mL	1 bottle
HI70024L	35.00 ppt (Marine Line)	500 mL	1 bottle
HI70024M	35.00 ppt (Marine Line)	230 mL	1 bottle

### Salinity Sachets

Code	Description	Size	Package
HI70024P	35.00 ppt (Marine Line)	20 mL	25 pcs





**Introduction.....6.2**

- Product Spotlights.....6.3
- Comparison Guide .....6.3

**Benchtop .....6.4**

**edge® ..... 6.16**

- edge.....6.16
- edge DO.....6.20

**Portable.....6.24**

- opdo™ Optical Dissolved Oxygen and BOD ..... 6.24
- Dissolved Oxygen and BOD .....6.28
- Aquaculture Specific .....6.31
- General Water Applications..... 6.32
- Manual Calibration ..... 6.33

**Probes.....6.34**

- Optical.....6.34
- edge Compatible..... 6.36
- Research Grade Slim ..... 6.37
- With Protective Sleeve.....6.38
- Galvanic.....6.39
- Standard .....6.40

**Solutions .....6.26-6.30**

## Dissolved Oxygen Theory and Measurement

Dissolved oxygen (DO) is a measure of how much oxygen is dissolved in a system. Measurements are usually taken in water using a DO probe and meter. Henry's Law states that the concentration of gas in a solution is directly proportional to the partial pressure of that gas above the solution. Henry's Law constant is a factor of proportionality, and so is specific to the gas in the solvent being measured.

The partial pressure of oxygen is in fact a measurement of the thermodynamic activity of its molecules. The rate at which oxygen dissolves, diffuses, and reacts is not determined by its concentration, but by its partial pressure. The Earth's atmosphere is composed of 20.9% oxygen, and at sea level the atmosphere is 100% saturated with oxygen.

Percent saturation is the amount of DO present per amount of DO possible at a given temperature and pressure. Percent saturation is a common unit for DO measurement since it is based upon the partial pressure of a gas; thus it is correct for determination in any solvent.

Concentration measurements of DO can also use the units of parts per million (ppm) or milligrams per liter (mg/L). In meters that report DO concentration in ppm or mg/L, the solvent is always assumed to be water. In other solvents such as oils or acids, the Henry's Law constant would be different. In those cases, percent saturation should be used as it is incorrect to use ppm or mg/L.

## Effects of Temperature and Pressure

As the temperature of a solution increases, the particle movement within that solution increases. With greater particle motion, dissolved gases escape more readily from solution. In warm water, oxygen is less soluble while in cold water, oxygen is more soluble. DO concentration in air saturated waters decreases with increasing temperature.

Atmospheric pressure decreases as altitude increases. Since there is lower partial pressure, oxygen is less soluble at higher altitudes. DO concentration in air saturated waters decreases with increasing elevations.

## Applications

**Water quality** measurements are vital to environmental monitoring. In quiescent lakes and rivers, the decay of organic matter can cause bacteria levels to increase. The aerobic bacteria consume oxygen, triggering a deficiency that can cause a water body "to die," killing aquatic plants and animals.

**Aquaculture** is the breeding, rearing, and harvesting of plants and animals in all types of water environments. Dissolved oxygen is needed by fish, zooplankton, and plants to survive and reproduce. DO measurements are used to monitor and control the environment required for success.

**Wastewater** treatment plants rely on bacteria to break down the organic compounds found in water. If the amount of dissolved oxygen in the wastewater is too low, these bacteria will die and septic conditions will occur. The amount of DO must be consistently monitored to ensure proper waste treatment.

**Wine and beer** are both affected by oxygen at various stages during production and storage. DO is an important parameter to monitor for those who wish to produce consistent, high quality products.

## Laboratory Monitoring of BOD, OUR and SOUR

**BOD (Biochemical Oxygen Demand)** is a measurement that indicates the concentration of biodegradable organic matter present in a water sample. It can be used to determine the general quality of water and its degree of pollution. BOD measures the rate of oxygen uptake by microorganisms in a water sample at a fixed temperature over a given period of time. To ensure that all other conditions are equal, a very small amount of microorganism seed is added to each sample being tested. The samples are kept at 20°C in the dark for five days. The loss of dissolved oxygen during incubation is called the BOD5. BOD is an empirical test that determines the relative oxygen requirements of wastewater, effluent, and polluted waters.

**OUR (Oxygen Uptake Rate)** is used to determine the biological activity of a system in terms of oxygen consumption or respiration rate. It is defined as the milligrams per liter of oxygen consumed per hour. This measurement indicates the rate of metabolic processes in sludge treatment, helping operators determine the stability of solids after digestion.

**SOUR (Specific Oxygen Uptake Rate)** also determines the oxygen consumption of a system, but is defined as the milligrams of oxygen consumed per gram of volatile suspended solids (VSS) per hour. This quick measurement has many advantages: rapid measure of influent organic load and biodegradability, indication of the presence of toxic or inhibitory wastes, degree of stability and condition of a sample, and calculation of oxygen demand rates at various points in the aeration basin.

## Types of Dissolved Oxygen Probes

Hanna's dissolved oxygen meters utilize one of two common types of sensing probes: polarographic sensors and galvanic sensors.

**Polarographic** DO probes consist of a working electrode (cathode) and a counter electrode (anode). A polarizing voltage is applied to these electrodes that is specific for the reduction of oxygen. A thin, gas permeable membrane isolates the sensor elements from the water sample but allows oxygen to pass through. The oxygen that passes through the membrane is reduced at the cathode, causing a current from which the oxygen concentration is determined. Two-electrode polarographic probes use the anode as a reference electrode.

**Galvanic** DO probes consist of a working electrode (cathode) and a counter electrode (anode) that act as a battery to produce a voltage specific for the reduction of oxygen. A thin, gas permeable membrane isolates the sensor elements from the water sample but allows oxygen to pass through. The oxygen that passes through the membrane is reduced at the cathode, causing a current from which the oxygen concentration is determined.





HI98198

## Optical Dissolved Oxygen Meter

*Professional dissolved oxygen measurement with digital optical probe*

The HI98198 opdo™ meter is a rugged, portable dedicated dissolved oxygen (DO) meter designed for fresh and saltwater measurements of dissolved oxygen. This professional, waterproof meter complies with IP67 standards and measures DO, barometric pressure, and temperature. The HI98198 is supplied with a HI764113 digital optical dissolved oxygen probe in a custom thermoformed durable carrying case with accessories. It is compact and ergonomically designed to provide ready access to the materials required for routine sampling.

[See page 6.16](#)

## Comparison Guide

	Dissolved Oxygen Range	Optical DO Meter	Barometric Pressure	% Saturation O <sub>2</sub>	Salinity Compensation	Altitude Compensation	Temperature Range(s)	DO Calibration Points	Barometric Pressure Calibration Points	ATC	Hold Feature	BEPS	PC Connectivity	Logging	Alarm	GLP	Capacitive Touch Buttons	Capacitive Touch Screen	Benchtop, Portable & Wall-Mount	Page
<b>Bench Meters</b>																				
HI6421	•	•	•	•	•	•	•	2	•	•	•	•	•	•	•	•	•	•	•	6.4
HI6421P	•	•	•	•	•	•	•	2	•	•	•	•	•	•	•	•	•	•	•	6.4
HI5421	•	•	•	•	•	•	°C/°F/K	2	1	•	•	•	•	•	•	•	•	•	•	6.14
edge	•	•	•	•	•	•	•	2	•	•	•	•	•	•	•	•	•	•	•	6.16
edge®DO	•	•	•	•	•	•	•	2	•	•	•	•	•	•	•	•	•	•	•	6.20
<b>Portable Meters</b>																				
HI98198	•	•	•	•	•	•	°C/°F	2	1	•	•	•	•	•	•	•	•	•	•	6.24
HI98193	•	•	•	•	•	•	°C/°F	2	1	•	•	•	•	•	•	•	•	•	•	6.28
HI9147	•	•	•	•	•	•	°C/°F	1	•	•	•	•	•	•	•	•	•	•	•	6.31
HI9146	•	•	•	•	•	•	°C	2	•	•	•	•	•	•	•	•	•	•	•	6.32
HI9142	•	•	•	•	•	•	°C/°F	2	•	•	•	•	•	•	•	•	•	•	•	6.33

## Advanced Dissolved Oxygen Meter

with Optical and Polarographic Probe Compatibility



HI6421 and HI6421P are streamlined benchtop meters with a large touch screen display, comprised of a housing and an integrated module designed for fresh and saltwater measurements of dissolved oxygen.

HI6421 includes Hanna's HI7641133 optical dissolved oxygen probe (opdo®) that is based on the principle of fluorescence quenching. An immobilized Pt-based luminophore is excited by the light of a blue LED and emits a red light. As oxygen interacts with the luminophore it reduces the intensity and lifetime of the luminescence. The lifetime of the luminescence is measured by a photodetector and is used to calculate the dissolved oxygen concentration.

The probe is fitted with easy to use Smart Caps (HI764113-1) which lock in place and contain pre-loaded calibration coefficients that are automatically transmitted to the probe. The Smart Cap features an immobilized O<sub>2</sub> sensitive luminophore with rugged insoluble black oxygen permeable protective layer.

Over time, the sensor's optical components can age but are compensated for by using the reference signal to compensate the measuring path. As a result, the sensor provides accurate DO measurements over long periods of time without the need for frequent calibration.

HI6421P includes the HI764833 polarographic probe. Slim and versatile, this probe covers a wide range of dissolved oxygen and has a built-in

thermistor temperature sensor that compensates for temperature variations. The slim design allows for convenient measurement in test tubes and Biological Oxygen Demand (BOD) bottles.

Durable and robust, the probe features a platinum cathode and Ag/AgCl anode assembly. Accurate and with a fast response time, readings are not flow dependent.

The probe is fitted with durable (PTFE), oxygen permeable, screw on membrane caps. Caps are filled with electrolyte and easily installed on the probe.

Concentration measurements are automatically compensated for barometric pressure, temperature, and salinity. Barometric pressure and temperature are automatically measured and compensated. Salinity is automatically compensated by setting manually the salinity concentration of the water being measured.

Additional features include built-in methods and calculations for the measurement of BOD (Biological Oxygen Demand), OUR (Oxygen Uptake Rate), and SOUR (Specific Oxygen Update Rate).

Pressure compensation is done automatically (built-in barometer) or users have the option to manually enter required value. Pressure is displayed in user-configurable units: mmHg, mbar, kPa, inHg, psi, atm.

## User interface

- 7-inch capacitive touch screen with multi-touch support
- Capacitive touch back, home and system menu keys
- User-friendly icons and symbols allow users to easily navigate and interpret the instrument functions.
- The user can select between five different views:
  - Basic measurement configuration
  - Simple GLP with calibration information
  - Full GLP with electrode status and calibration point details
  - Live updated, interactive graph
  - Tabulated data with date, time, and notes

## Measurement

- Measure %Sat, mg/L, ppm (DO); mg/L, ppm (BOD); mg/L (OUR); ppm, mg/L (SOUR)
- Application-specific profiles allow quick and direct measurement without the need to update the sensor and system settings

- Active log during measurement
- Measurement stability indicator (using the Stability Criteria setting)
- Reading modes: direct and direct/autohold
- Temperature compensation can be Automatic or set manually
- Audible and/or alarm messages for measurements outside of predefined limits
- Galvanic isolation for measurement

## Calibration

- One or two points calibration at 0% and/or 100% saturation
- Single point manual calibration in mg/L or % saturation using a reference method
- Non-volatile memory saves data and settings

## Logging

- Data log collection of at least 1,000,000 data points (with time and date stamp)

- Logging types: manual, automatic, autohold
- Sample ID for manual and Autohold data

## Connectivity features & services

- Transfer logged data to a USB thumb drive
- Log files that include measurements and calibration data (as .csv file)
- FTP and email for log export via Ethernet and Wi-Fi connection
- USB type A for USB stick, keyboard, and printer
- USB type C for USB stick and PC connection

## Help section for meter guidance

- Video support presentation of main functionalities



This system responds to a complex range of measurement and monitoring requirements, providing accuracy, reproducibility, and reliability.

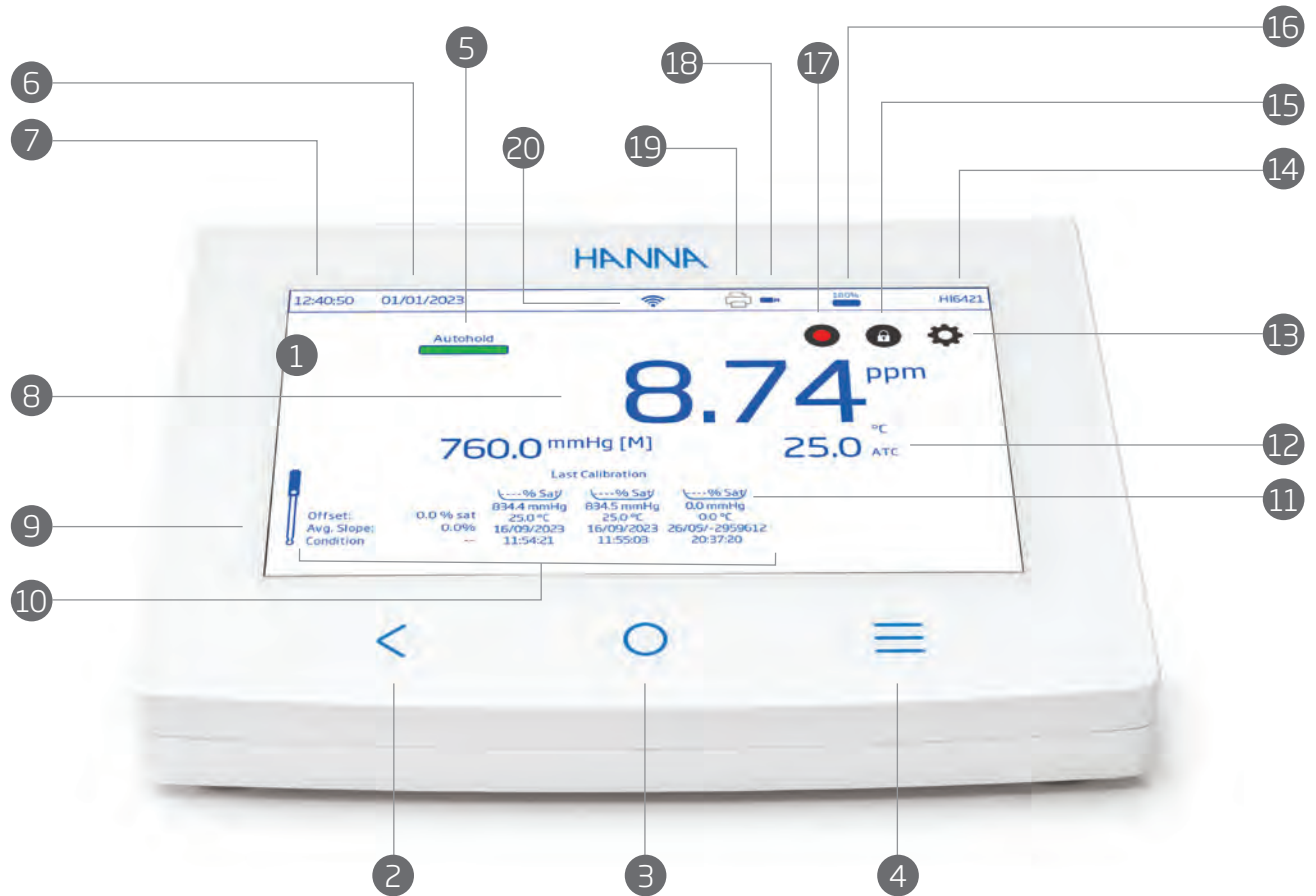

### 1. Capacitive touch screen with multi-touch support

The benchtop unit has a 7-inch color display with 800 x 480p resolution. The capacitive, multi-touch screen supports video playback and data plotting.

### 2. Back key

### 3. Home key

### 4. System Menu key

This key will enter the system menu where User accounts, System Settings, and Logging can be configured. The Help menu is also accessed on the system menu screen.

### 5. Stability indicator

### 6. Current date

### 7. Current time

### 8. Main reading

### 9. Probe icon

### 10. Calibration information: Electrode condition, Offset, Slope, Date and Time

### 11. Buffer trays

### 12. Temp. reading

### 13. Measurement setup menu

Opens sensor setup parameters.

### 14. User name (default shown)

### 15. Direct/Autohold Readings

When Direct/Autohold is selected, measurement reading is held on display when measurement stability is reached. This option removes the subjective nature of stability as a measurement that has not reached equilibrium will not be used.

When not selected, sample measurements are displayed continuously.

### 16. Logging space availability

### 17. Logging start

### 18. USB connection status

### 19. Peripheral connection status

### 20. Wireless network connection status

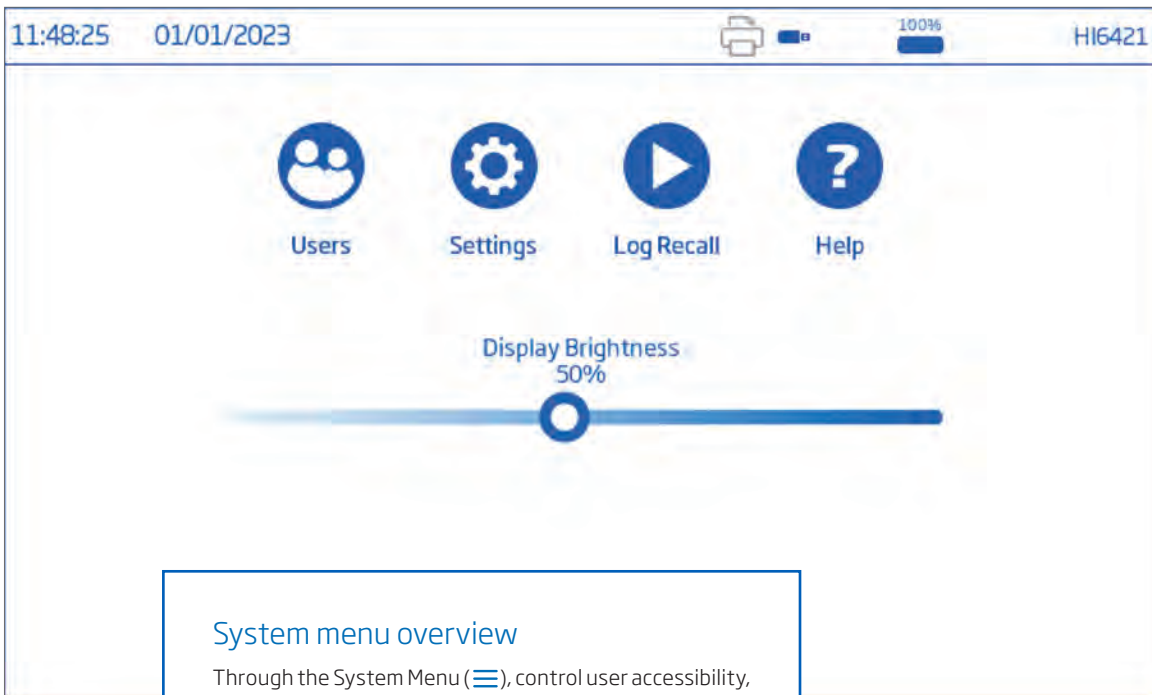

**System menu overview**

Through the System Menu (☰), control user accessibility, system and connectivity configuration, access logged data and video-supported help.

- Add and delete user accounts through Users (👤).
- Access Network Connectivity, System and Info tabs through Settings (⚙️).
- Log Recall (▶️) recalls stored log sessions (Automatic continuous logging, Manual, or Autohold).
- Help (❓) guides users with video-supported help.





## Users



### Custom Users

New administrator or standard user accounts can be created. Standard accounts can be configured for specific accessibility.

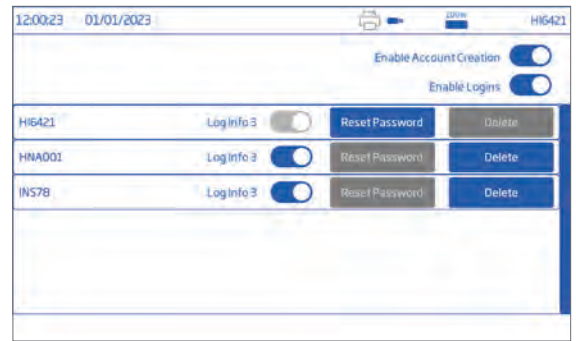

### User Account Management

Administrators can create and manage accounts from the Account Management Screen.



## Settings

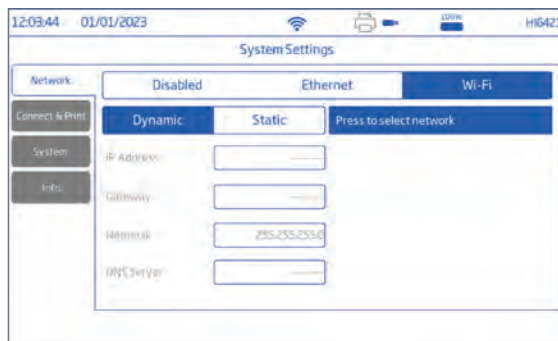

### Network Screen

Determine how measurement logs are shared through network settings. Users can select network to be connected via Ethernet or Wi-Fi, or Disabled.

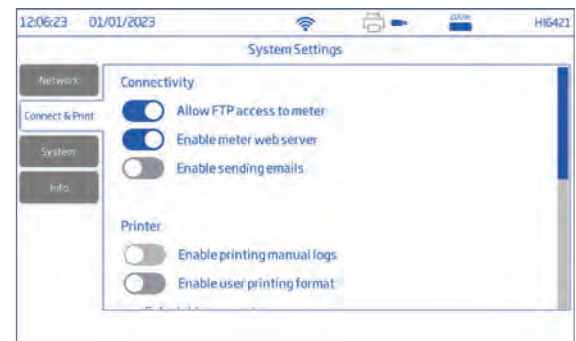

### Connect and Print Screen

Activate connectivity options to allow the meter to connect to other devices.

- FTP access to meter, permits log file transfer to a FTP site and to connect the meter FTP server to a client for log download.
- Meter web server, permits log file download to a web client.
- Sending emails, permits log files to be transferred by email.

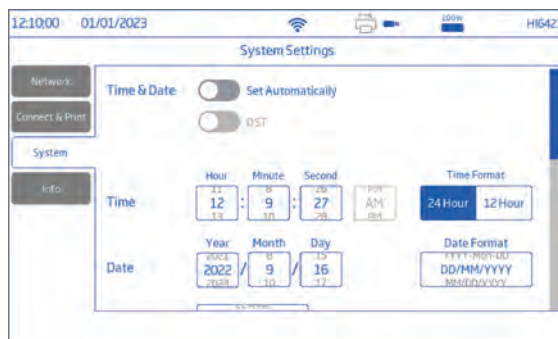

### System Screen

The system screen enables users to configure options such as: Time, Date, Language, Meter ID, Decimal Separator, Backlight Saver, Audible signals, Startup Tutorial, and Factory Settings restore.

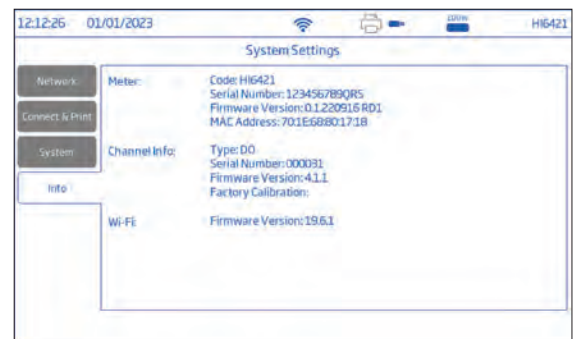

### Info Screen

Displays information on meter, channel serial number, and Wi-Fi firmware version.



## Log Recall

Name	Parameter	Start/Stop	Share To
20220916_121743-DO_auto.csv	Dissolved Oxygen	12:17:43 16/09/2022 12:18:06 16/09/2022	USB A
20220916_121809-DO_auto.csv	Dissolved Oxygen	12:18:10 16/09/2022 12:18:41 16/09/2022	Cancel
20220916_121901-DO_auto.csv	Dissolved Oxygen	12:19:01 16/09/2022 12:19:44 16/09/2022	44
20220916_122000-DO_auto.csv	Dissolved Oxygen	12:20:00 16/09/2022 12:20:46 16/09/2022	39
20220916_122546-DO_auto.csv	Dissolved Oxygen	12:25:46 16/09/2022 12:26:14 16/09/2022	29
20220916_123021-DO_auto.csv	Dissolved Oxygen	12:30:21 16/09/2022 12:31:07 16/09/2022	47
		12:32:22 16/09/2022	

## Log History and Sharing

The item allows users access and management (selection, deletion, and sharing) of measurement data. Only the user who generated the data has access to the logs created by that user.

Data can be viewed tabulated (complete with date, time, and notes), or plotted (as graph).

Log files can be shared via USB, FTP, web server and email.

Sample ID	Date	Time	% Sat	mmHg	Notes
7	16/12/2022	12:17:43	0.000	0.0	X "Factory calibration expire [more]
7	16/12/2022	12:17:44	0.000	0.0	X "Factory calibration expire [more]
7	16/12/2022	12:17:45	0.000	0.0	X "Factory calibration expire [more]
7	16/12/2022	12:17:46	0.000	0.0	X "Factory calibration expire [more]
7	16/12/2022	12:17:47	0.000	0.0	X "Factory calibration expire [more]
7	16/12/2022	12:17:48	0.000	0.0	X "Factory calibration expire [more]
7	16/12/2022	12:17:49	0.000	0.0	X "Factory calibration expire [more]
7	16/12/2022	12:17:50	0.000	0.0	X "Factory calibration expire [more]
7	16/12/2022	12:17:51	0.000	0.0	X "Factory calibration expire [more]
7	16/12/2022	12:17:52	0.000	0.0	X "Factory calibration expire [more]

## Table View

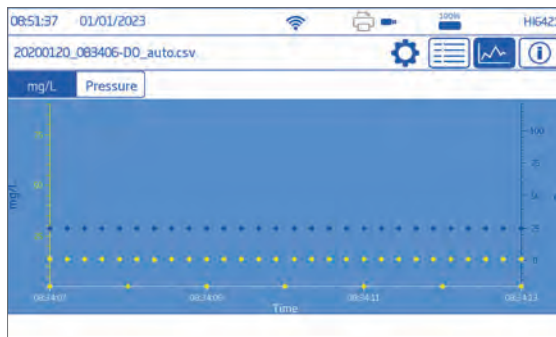

## Graph View

**20220920\_072558-DO\_auto.csv**

**INSTRUMENT INFO**  
 Instrument Name: HI6421-ID1  
 ID: HI6421  
 Serial Number: 123456789QRS  
 Firmware Version: 0.1.220916.R01

**INTERFACE INFO**  
 Module Type: DO  
 Module Serial Number: 000031  
 Module Firmware: 4.1.1

**GLP DATA**  
 Calibration point: 3.0%

Date/Time: 16/09/2022 11:54:21

## Log Detail

Tapping the information icon displays log details such as user and profile name, instrument name and serial number, channel, lot information, as well as GLP data.



## Help

**Hanna Tutorial System**

- 1. HI6221 First Look
- 2. Getting Started
  - 2.1. Get familiar with functionalities
  - 2.2. Users
  - 2.3. Meter settings
  - 2.4. Setting measurement
- 3. General Operations
- 4. General Operations
- 5. Troubleshooting guide
- 6. Accessories and Warranty

**2.1. Get familiar with functionalities**  
**Screens explained**  
**Main View** - This screen shows the current measurement according to the measurement settings and give access to the user calibration and measurement settings options.

**Main Menu** - This screen gives the user access to the 5 main icons

**Hanna Tutorial System**

- 1. HI6221 First Look
- 2. Getting Started
  - 2.1. Get familiar with functionalities
  - 2.2. Users
  - 2.3. Meter settings
  - 2.4. Setting measurement
- 3. General Operations
- 4. General Operations
- 5. Troubleshooting guide
- 6. Accessories and Warranty

**2.4. Setting up measurement**  
 Your measurement screen can be configured by pressing **Q**.

**Channel Settings**

**READING**

Mode: pH, mV, Rel. mV

## On-board Help

The HELP menu supports users with a brief overview of the system's main functionalities through text and video tutorials.



## Measurement Setup Configuration

12:46:02 01/01/2023 H16421

Channel Settings

Calibration: Stability Criteria: Accurate Medium Fast

Reading: Parameter: DO BOD<sub>5</sub> OUR SOUR

Temperature: Units: % Sat mg/L ppm

View: Pressure Source: Automatic Manual

Alarm: Pressure: 760.0

Logging: Pressure Unit: mmHg mbar kPa

Profiles:

### Reading

Customize measurement options such as Stability Criteria, Parameter, Units, Pressure Source, Pressure Unit.

12:47:26 01/01/2023 H16421

Channel Settings

Calibration: Temperature Source: Manual MOD1 Manual

Reading: Temperature Unit: °C °F K

View: Manual: 25.0 °C

Alarm: Last Calibration: Calibrate Clear

Logging: Profiles:

### Temperature

Customize temperature options such as Automatic or manual temperature Source, °C, °F, or K temperature Unit, Manual Temperature input, or clear last temperature calibration.

12:44:40 01/01/2023 H16421

Channel Settings

Calibration: Last Calibration: Calibrate Clear

Reading: Calibration Type: Automatic Manual

Temperature: Calibration Remider: Disabled Daily Periodic

View: Alarm: Logging: Profiles:

### Calibration

Customize calibration options such as Last Calibration, Automatic or Manual calibration, and Daily or Periodic Calibration Remider

12:51:19 01/01/2023 H16421

Channel Settings

Calibration: High DO: 0.0 % Sat

Reading: Low DO: 0.0 % Sat

Temperature: High Pressure: 800.0 mmHg

View: Low Pressure: 460.0 mmHg

Alarm: High Temperature: 50.0 °C

Logging: Low Temperature: 10.0 °C

Profiles:

### Alarm

Alarm configuration allows users to set the high and low threshold limits for the measured parameters. When the parameter is enabled and the the measurement exceeds the high-limit value or drops below the low-limit value, the alarm is triggered and will appear on the message banner along with an audible alarm (if Alarm Beepers is enabled).

12:52:51 01/01/2023 H16421

Channel Settings

Calibration: Log Info 1

Reading: Log Info 2

Temperature: Log Info 3

View: Log Info 4

Alarm: Sample ID: None Increment Manual

Logging: Sample ID Prefix: 0 0 0 1 1 1

Profiles:

### Logging

Logging Type (automatic, manual or autohold), Sampling Period (Automatic), Logging Resolution, File Name (with Manual type selected), Log Note and Info, Sample ID (Increment or Manual) can be configured under this option menu.

12:55:08 01/01/2023 H16421

Channel Settings

Calibration: Current Profile: Chem-Lab-04

Reading: Save As Save Delete

Temperature: Load Profile: Chem-Lab-04

View: Alarm: Logging: Profiles:

### Profiles

A profile is a sensor setup complete with required measurement unit, temperature unit, display preference, and alarm threshold options.

Once saved the profile can be loaded for applications that require similar configurations.



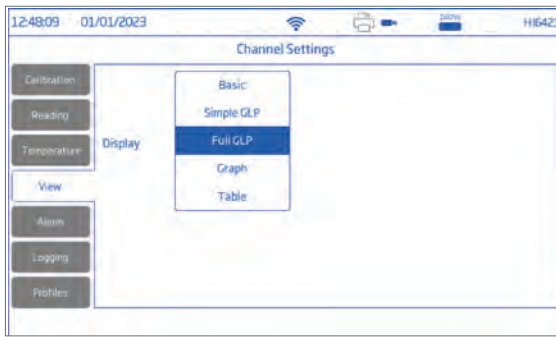

### View Configuration

This screen allows users to select the preferred display configuration. Option to select between: Basic, Simple GLP, Full GLP, Graph, Table.



### Basic View

Basic screen displays the measured value, measurement unit as well as temperature source.



### Simple GLP View

In addition to data displayed when Basic option is selected, screen also displays: last calibration date and time and offset value.

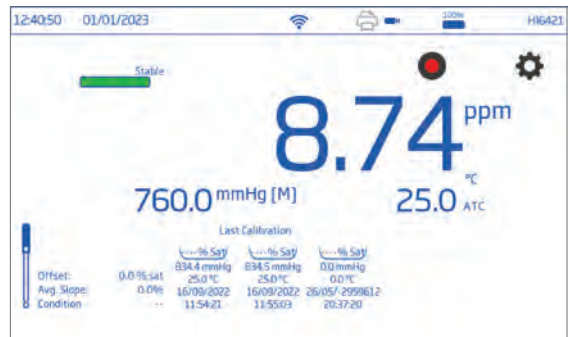

### Full GLP View

In addition to data displayed when Simple GLP option is selected, screen also displays: electrode symbol, used buffers trays together with calibration date and time.



### Graph View

When Graph is selected, the measured value is plotted as a graph.

ppm	mmHg	T(°C)	Time	Date	Notes
8.1	760.0	25.0	12:42:41	16/12/2022	
8.1	760.0	25.0	12:42:40	16/12/2022	
8.1	760.0	25.0	12:42:39	16/12/2022	
8.1	760.0	25.0	12:42:38	16/12/2022	
8.1	760.0	25.0	12:42:37	16/12/2022	
8.1	760.0	25.0	12:42:36	16/12/2022	
8.1	760.0	25.0	12:42:35	16/12/2022	
8.7	760.0	25.0	12:42:34	16/12/2022	
8.7	760.0	25.0	12:42:33	16/12/2022	
8.7	760.0	25.0	12:42:32	16/12/2022	
8.7	760.0	25.0	12:42:31	16/12/2022	

### Table

When Table is selected, the measured values are displayed tabulated (complete with date, time, and notes made during logging). The newest data is displayed on the top of the table.

## Electrode Holder

HI6421 and HI6421P is supplied with an electrode holder featuring a flexible arm. The holder can be mounted on either side quickly and provides secure support for electrodes while taking measurements in sample containers.



## Rear Ports

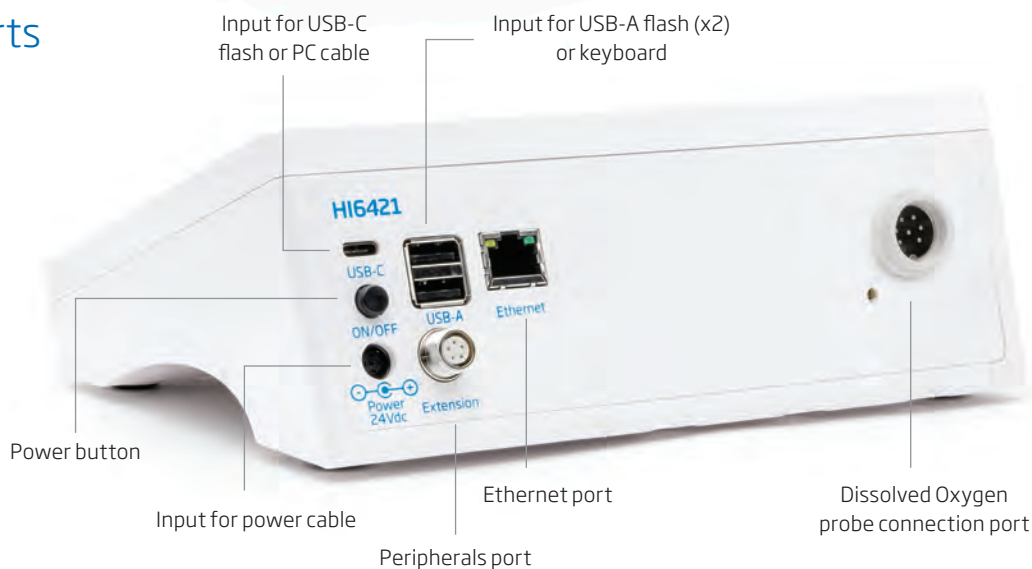

### Specifications

#### HI6421 • HI6421P

DO (HI7641133 Optical probe)	Range	0.00 to 50.00 mg/L (ppm) concentration; 0.0 to 500.0 % saturation
	Resolution	0.01 mg/L (ppm); 0.1 % saturation
	Accuracy	from 0.00 to 20.00 mg/L (ppm) 1.5 % of reading or $\pm 0.01$ mg/L (ppm), whichever is greater from 20.00 to 50.00 mg/L (ppm) $\pm 5$ % of reading from 0.0 to 200.0 % saturation $\pm 1.5$ % of reading or $\pm 0.1$ %, whichever is greater from 200.0 to 500.0 % saturation $\pm 5$ % of reading
DO (HI764833 Polarographic probe)	Range	0.00 to 90.00 mg/L (ppm) concentration; 0.0 to 600.0 % saturation
	Resolution	0.01 mg/L (ppm); 0.1 % saturation
	Accuracy	$\pm 1.5$ % of reading $\pm 1$ , least significant digit

Barometric Pressure	Range	450 to 850 mmHg; 600 to 1133 mBar; 60 to 133 kPa; 17 to 33 inHg; 8.7 to 16.4 psi; 0.592 to 1.118 atm
	Resolution	1 mmHg; 1 mBar; 1 kPa; 1 inHg; 0.1 psi; 0.001 atm
	Accuracy	±3 mmHg within ±15 % from the calibration point ±3 mmHg ±1 least significant digit
Temperature	Range	-20.0 to 120.0 °C -4.0 to 248.0 °F 253.0 to 393.0 K
	Resolution	0.1 °C; 0.1 °F; 0.1 K
	Accuracy	±0.2 °C; ±0.4 °F; ±0.2 K
DO Calibration	Points	DO optical One or two points automatic calibration at 100% (8.26 mg/L) and 0% (0 mg/L). Single point manual using a value entered by the user in % saturation or mg/L. DO polarographic Automatic-two points / User standard-single point
	Standards	0 and 100% saturation
	Reminder	Disabled Daily: 0 min. to 23 hours and 59 min. Periodic: 1 min. to 500 days, 23 hours and 59 min.
Temperature Compensation		Automatic or Manual
Salinity Compensation (Optical DO only)		Automatic from 0 to 70 PSU (manually set) 0.0 to 70.0 % / 0.0 to 45.0 g/L / 0.0 to 42.0 psu
Reading	Modes	Direct Direct/Autohold
	Stability criteria	Accurate Medium Fast
	Isopotential	7.000 or 4.010
	Sampling rate	1000 ms
DO Views	Basic	Measurement (DO, Temperature) Stability status
	Simple GLP	Basic view information Last calibration date, offset, average slope
	Full GLP	Simple GLP information and calibration point details
	Table	Measurements updated every second are displayed in table
	Graph (Plot)	Measurement versus time graph can be panned or zoomed (pinch-to-zoom technology)
Logging	Type	Automatic, Manual, Autohold
	Number of records	50 000 maximum per file Stores at least 1 000 000 data points per user
	Automatic interval	1, 2, 5, 10, 30 seconds 1, 2, 5, 10, 15, 30, 60, 120, 150, 180 minutes
	Sample ID	Incremental mode
Export option		.csv file format
Users		Up to 9 users and the default administrator account
Connectivity	USB-A	2 ports for keyboard input or USB thumb drive
	USB-C	1 port for PC connectivity and USB-C type thumb drive
	Wi-Fi & Ethernet	FTP Web server Log transfer and download Email
	RS232	Connecting peripherals
Power supply		DC adapter 100-240AC to 24VDC 2.5A
Environment		0 - 50 °C / 32 - 122 °F / 273 - 323 K maximum 95% RH non-condensing
Dimensions		205 x 160 x 77 mm (8.0 x 6.2 x 3.0")
Weight		Approximately 1.2 kg (26.5 lbs.)
Ordering Information	<b>HI6421</b> is supplied with HI7641133 optical dissolved oxygen probe (opdo®); HI764060 electrode holder; capillary pipette; 24 VDC power adapter; USB-C to USB-A cable; probe quality certificate; quick reference guide with instrument quality certificate.	
	<b>HI6421P</b> is supplied with HI764833 polarographic probe; HI764060 electrode holder; capillary pipette; 24 VDC power adapter; USB-C to USB-A cable; probe quality certificate; quick reference guide with instrument quality certificate.	

# Research Grade Bench Meter

*Dissolved Oxygen and BOD*



The HI5421 is an advanced research grade benchtop Dissolved Oxygen and BOD meter that is completely customizable with a large color LCD, capacitive touch keys, and USB port for computer connectivity. The HI5421 is rich in features including data logging, alarm limits, comprehensive GLP, and many more while retaining simplicity in use with both dedicated keys for routine operation and virtual keys that guide the user through setup options.

## Customizable User Interface

The user interface of the HI5421 allows the user to show measurements in various modes: basic measurement with or without GLP information, real-time graphing, and logging data. Calibration stability criteria can be adjusted from fast, moderate, and accurate. Programmable alarm limits can be set to inside or outside allowable limits.

## Color Graphic LCD

The HI5421 features a color graphic LCD with on-screen help, graphic, and custom color configurations. The display allows for real-time graphing and the use of virtual keys provide for an intuitive user interface.

## Capacitive Touch

The HI5421 features sensitive capacitive touch buttons for accurate keystrokes when navigating menus and screens. There are four dedicated keys that are used for routine operations including calibration and switching measurement modes and four virtual keys that change based upon use. The capacitive touch technology ensures the buttons never get clogged with sample residue.

## Built in Barometer

Readings are compensated for barometric pressure by a built in pressure transducer located in the meter. Calibration of the barometric pressure is single point with manual entry of current value obtained from local weather service or other device. Barometric pressure is displayed in a multiple choice of units including mmHg, mbar, kPa, mHg, psi, and atm.

## Choice of Calibration

Automatic standard recognition is available for two points at 0% and 100% saturation or 0 mg/L and 8.26 mg/L. A user standard option is available for a user defined value.

## BOD, OUR and Sour Measurement Modes

An additional three measurement modes are available to measure Biological Oxygen Demand (BOD), Oxygen Uptake Rate (OUR) and Specific Oxygen Uptake Rate (SOUR). Simply enter values and take readings at appropriate times and the meter will automatically calculate the values.

## Automatic Salinity Compensation

The HI5421 allows for automatic salinity compensation with a selectable salinity range of 0 to 45 g/L.

## GLP Data

View calibration data and calibration expiration information by selecting the Good Laboratory Practice (GLP) display option. Calibration data include date, time, and calibration points.

## Data Transfer

Data can be transferred to a PC with USB cable and HI92000 software (both sold separately).

## Data Logging

Three selectable logging modes are available on the HI5421: automatic, manual, and AutoHold logging. Automatic and manual logs up to 100 lots with 50,000 records max/lot, with up to 100,000 total data points. Automatic logging features the option to save data according to sampling period and interval.

## Contextual Help

Contextual help is always available through a dedicated "HELP" key. Clear tutorial messages and directions are available on-screen to quickly and easily guide users through setup and calibration. The help information displayed is relative to the setting/option being viewed.



## DO probe included

The HI5421 is supplied with the HI76483 Clark-Type Polarographic probe. This probe is only 12 mm in diameter and has a built-in thermistor temperature sensor that compensates for temperature variations from 0 to 50°C.

Specifications	HI5421	
Dissolved Oxygen	Range	0.00 to 90.00 ppm (mg/L); 0.0 to 600.0 % saturation
	Resolution	0.01 ppm; 0.1% saturation
	Accuracy	±1.5% of reading ±1 LSD
	Calibration	automatic using single or two-point calibration; user calibration single point
Barometric Pressure	Range	450 to 850 mmHg; 600 to 1133 mBar; 60 to 133 KPa; 17 to 33 inHg; 8.7 to 16.4 psi; 0.592 to 1.118 atm
	Resolution	1 mmHg; 1 mBar; 1 kPa; 1 inHg; 0.1 psi; 0.001 atm
	Accuracy	±3 mm Hg + 1 least significant digit
Temperature	Range	-20.0 to 120°C; -4.0 to 248.0°F; 253.15 to 393.15K
	Resolution	0.1°C; 0.1°F; 0.1K
	Accuracy	±0.2°C; ±0.4°F; ±0.2K (without probe)
Additional Specifications	Measurement Modes	direct DO; BOD (biochemical oxygen demand); OUR (oxygen uptake rate); SOUR (specific oxygen uptake rate)
	Temperature Compensation	0.0 to 50.0°C; 32.0 to 122.0°F; 237.1 to 323.1 K
	Salinity Compensation	0 to 45 ppt
	Barometric Pressure Calibration	single point calibration
	Probe	HI76483 thin body, polarographic dissolved oxygen probe with internal temperature sensor and 1 m (3.3') cable (included)
	Record Samples Logging	Up to 100 lots; 50,000 records max./lot, maximum 100,000 data points; 5000 samples/lot for Manual Logging
	Interval Logging	14 selectable between 1 second and 180 minutes
	Logging Type	manual AutoHOLD, automatic
	Alarm (DO, BOD, OUR, SOUR)	inside and outside limits
	PC Connection	opto-isolated USB
Display	graphic color LCD with 240x340 pixels	
Power Supply	12 VDC adapter (included)	
Dimensions	160 x 231 x 94 mm (6.3 x 9.1 x 3.7")	
Weight	1.2 kg (2.6 lbs.)	
Ordering Information	HI5421-01 (115V) and HI5421-02 (230V) is supplied with HI76483 DO probe, HI7041S electrolyte solution (30 mL), DO membrane caps (2), O-rings for DO membrane cap, HI76404W electrode holder, 12 VDC adapter, quality certificates, quick start guide and instruction manual.	

## On-screen Features

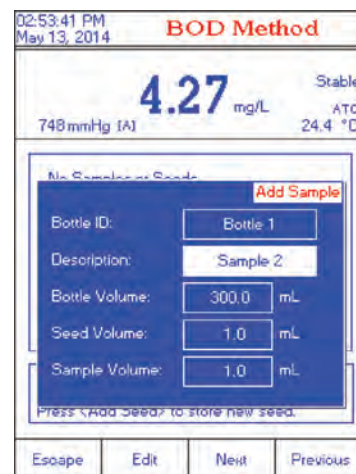

BOD (Biological Oxygen Demand)

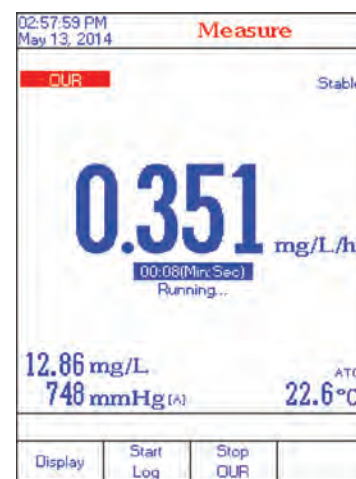

OUR (Oxygen Uptake Rate)

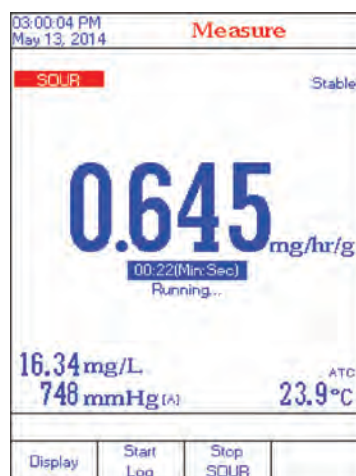

SOUR (Specific Oxygen Uptake Rate)



## The world's most innovative pH, EC and DO meter

edge's groundbreaking design is the culmination of Hanna's vision, design capabilities, integrated production and world class R&D. The edge is rich in features to accommodate the needs of a vast amount of customers. For those that prefer very simplistic operation there is a basic mode operation with simplified menu and options while for those who require advanced features there is the full featured standard operating mode. edge is available as a pH, conductivity or dissolved oxygen kit and any edge kit can be upgraded with additional probes to measure pH, conductivity and dissolved oxygen.

## edge® technical features

### Rechargeable Battery

edge has a built in rechargeable battery that is charged when the meter is in the plugged in benchtop or wall mount cradle. The battery can also be recharged through the micro USB port with either a USB port from a computer or directly to the power supply.



### Two USB ports

edge includes one standard USB for exporting data to a flash drive. edge also includes one micro USB port for exporting files to your computer as well as for charging when the cradle is not available.



### Clear, full text readout

edge features clear, full text guides displayed on the bottom of the screen. There is no need to decipher scrambled abbreviations or symbols; these helpful messages guide you through every process quickly and easily.



### Data logging

edge allows you to store up to 1000 log records of data. Data sets include readings, GLP data, date and time.

\* Using edge compatible pH electrodes



### GLP

Data of the last calibration you perform is stored in the sensor including the date, time, and buffers used. When the sensor is connected to edge, GLP data is automatically transferred.

### Two Operating Modes

edge can be used in Extended or Basic Operating Modes. Extended Mode enables all edge features while Basic Mode reduces features—ideal for routine measurements by displaying a simplified screen and features.

### edge pH Features\*



#### CAL Check™ (pH only)

Hanna's exclusive CAL Check feature analyzes the pH electrode response in the pH buffers during the calibration process to alert the user of potential problems such as a contaminated buffer or dirty electrode. After calibration, indicators for probe condition are displayed on the measurement screen. The probe condition is based on offset and slope characteristics of the pH electrode.

#### Sensor Check™ (pH only)

When used with Hanna's electrodes equipped with a matching pin, edge constantly checks the impedance of the pH measuring electrode to notify you in real time in the event of glass breakage. During calibration, Sensor Check checks the state of the junction. The reference junction is also evaluated and reported on the display.

#### ORP Measurement

edge measures ORP with edge compatible ORP probes.

## edge design features



### Capacitive touch keypad

edge features sensitive capacitive touch buttons for accurate keystrokes when navigating edge's menus and screens. Since they are part of the screen, the buttons can never get clogged with sample residue.



### Easy to read LCD

edge features a 5.5" (14 cm) LCD display that you can clearly view from over 5 m (16.4'). The large display, with its wide 150° viewing angle, provides one of the easiest to read LCDs in the industry.



### Zero footprint

Using the wall mount cradle (included), edge can be placed on a wall, leaving zero footprint on the benchtop space. The cradle has a built-in connector to power and charge the batteries.



## Hybrid meters that can be used in portable, wall-mount and benchtop configurations

The versatile design of edge® enables it to be used as a portable, wall-mount or benchtop meter. edge simplifies measurement, configuration, calibration, diagnostics, logging and transferring data directly to a computer or USB drive.



### Portable field unit

edge is ideal for field use due to its light weight, large screen, and thin design. It can easily be slipped into a backpack or messenger bag. The battery life lasts up to 8 hours when used as a portable device.



### Wall-mount cradle

The included wall-mount cradle makes it easy to conserve space on the benchtop while also charging edge with the AC adapter. The cradle is ideal for continuous monitoring applications.



### Electrode holder with built-in cradle

The electrode holder features a swivel, adjustable arm with a built-in cradle to hold edge securely in place at the optimum viewing angle.





## Digital electrodes

edge® measures pH, conductivity and dissolved oxygen through its unique digital electrodes. These digital electrodes are auto-recognized, providing sensor type, calibration data and a serial number when connected to edge by an easy to plug-in 3.5mm connector.

- Simply connect each probe via the 3.5 mm jack, Digital Smart Electrodes are automatically recognized

- Clark type digital polarographic probe with easy-to-replace membrane cap
  - Covers all ranges from 0.00 to 45.00 mg/L (ppm); 0.0 to 300% saturation
- Accuracy  $\pm 1.5\%$  full scale
- One or two-point calibration (HI7040), 0% (solution) and 100% (air)
- Data logging
  - Manual log-on-demand
  - Manual log-on-stability
  - Interval logging
- Automatic Temperature Compensation from 0 to 50 °C
- GLP data
  - Records date, time, calibration standards, altitude value and salinity value

- Altitude compensation from -500 to 4000 meters (-1640 to 13,123')
- Salinity compensation from 0 to 40g/L



### Sleek design

Incredibly thin and lightweight, edge measures just 1/2" (12 mm) thick and weighs just 8.8 ounces (250 g).

All edge compatible pH, EC and dissolved oxygen digital probes are interchangeable with edge.

Specifications	HI2040 edge	
Dissolved Oxygen	Range	0.00 to 45.00 ppm (mg/L); 0.0 to 300.0% saturation
	Resolution	0.01 ppm (mg/L); 0.1 % saturation
	Accuracy	$\pm 1.5\%$ of reading $\pm 1$ digit
	Calibration	one or two-point at 0% (HI7040 solution) and 100% (in air)
	Temperature Compensation	ATC (0 to 50°C; 32.0 to 122.0°F)*
	Salinity Compensation	0 to 40 g/L (with 1 g/L resolution)
	Altitude Compensation	-500 to 4000 m (-1640 to 13120') (with 100 m (328') resolution)
Temperature	Range*	-20.0 to 120.0°C; -4.0 to 248.0°F
	Resolution	0.1°C; 0.1°F
	Accuracy	$\pm 0.5^\circ\text{C}$ ; $\pm 0.9^\circ\text{F}$
Additional Specifications	Probe (included in DO kit)	HI764080 digital dissolved oxygen electrode with 3.5 mm (1/8") connector and 1 m (3.3') cable
	Logging	up to 1000 records organized in: manual log-on-demand (max. 200 logs), manual log-on-stability (max. 200 logs), interval logging (max. 600 samples; 100 lots)
	Connectivity	1 USB port for storage; 1 micro USB port for charging and PC connectivity
	Environment	0 to 50°C (32 to 122°F); RH max 95% non-condensing
	Power Supply	5 VDC adapter (included)
	Dimensions / Weight	202 x 140 x 12 mm (7.9" x 5.5" x 0.5") / 250 g (8.82 oz.)
Ordering Information	<p><b>HI2040-01</b> (115V) and <b>HI2040-02</b> (230V) DO kit also includes: HI764080 dissolved oxygen electrode, HI7041S refill electrolyte solution, DO membrane caps (2), o-rings (2)</p> <p>All edge compatible pH, EC and DO digital probes are interchangeable with HI2040 and can be ordered separately.</p>	

\* temperature limits will be reduced to actual probe limits



## edge DO–Innovation in a Single Parameter

edge DO's groundbreaking design is the culmination of Hanna's vision, design capabilities, integrated production and world class R&D. edge DO is a single meter that can measure pH and ORP and is incredibly easy to use.

### Additional feature information

- Clark type digital polarographic probe with easy-to-replace membrane cap
  - Covers all ranges from 0.00 to 45.00 mg/L (ppm); 0.0 to 300% saturation
- Accuracy  $\pm 1.5\%$  full scale
- One or two-point calibration (HI7040), 0% (solution) and 100% (air)
- Data logging
  - Manual log-on-demand
  - Manual log-on-stability
  - Interval logging
- Automatic Temperature Compensation from 0 to 50 °C
- GLP data
  - Records date, time, calibration standards, altitude value and salinity value
- Altitude compensation from -500 to 4000 meters (-1640 to 13,123')
- Salinity compensation from 0 to 40g/L

## edge®DO technical features

### Rechargeable Battery

edge DO has a built in rechargeable battery that is charged when the meter is in the plugged in benchtop or wall mount cradle. The battery can also be recharged through the micro USB port with either a USB port from a computer or directly to the power supply.



### Two USB ports

edge DO includes one standard USB for exporting data to a flash drive. edge also includes one micro USB port for exporting files to your computer as well as for charging when the cradle is not available.



### Clear, full text readout

edge DO features clear, full text guides displayed on the bottom of the screen. There is no need to decipher scrambled abbreviations or symbols; these helpful messages guide you through every process quickly and easily.



### Data logging

edge DO allows you to store up to 1000 log records of data. Logging data sets include readings, GLP data, date and time.



### GLP

Data of the last calibration you perform is stored in the sensor including the date, time, and buffers used. When the sensor is connected to edge DO, GLP data is automatically transferred.

## edge DO design features



### Capacitive touch keypad

edge DO features sensitive capacitive touch buttons for accurate keystrokes when navigating edge's menus and screens. Since they are part of the screen, the buttons can never get clogged with sample residue.



### Easy to read LCD

edge DO features a 5.5" (14 cm) LCD display that you can clearly view from over 5 m (16.4'). The large display, with its wide 150° viewing angle, provides one of the easiest to read LCDs in the industry.



### Zero footprint

Using the wall mount cradle (included), edge DO can be placed on a wall, leaving zero footprint on the benchtop space. The cradle has a built-in connector to power and charge the batteries.



### 3.5 mm probe input

Plugging an electrode in has never been simpler; no alignments or broken pins, simply connect the 3.5 mm plug and begin. Digital electrodes are automatically recognized.



### Sleek design

Incredibly thin and lightweight, edge measures just 1/2" (12 mm) thick and weighs just 8.8 ounces (250 g).

## Accepts edge DO compatible dissolved oxygen probe



## A hybrid meter that can be used in portable, wall-mount and benchtop configurations

The versatile design of edge DO enables it to be used as a portable, wall-mount or benchtop meter. edge DO simplifies measurement, configuration, calibration, diagnostics, logging and transferring data directly to a computer or USB drive.



### Portable field unit

edge DO is ideal for field use due to its light weight, large screen, and thin design. It can easily be slipped into a backpack or messenger bag. The battery life lasts up to 8 hours when used as a portable device.



### Wall-mount cradle

The included wall-mount cradle makes it easy to conserve space on the benchtop while also charging edge DO with the AC adapter. The cradle is ideal for continuous monitoring applications.



### Electrode holder with built-in cradle

The electrode holder features a swivel, adjustable arm with a built-in cradle to hold edge pH securely in place at the optimum viewing angle.

## Digital electrodes

edge®DO performs measurements through its unique digital electrodes. These digital electrodes are auto-recognized, providing sensor type, calibration data and a serial number when connected to edge DO by an easy to plug-in 3.5 mm connector.

### Dissolved oxygen electrode

#### HI764080 (included)

Dissolved oxygen electrode with temperature sensor

**Recommended for general purpose**



## Specifications

### HI2004 edge DO

Dissolved Oxygen	Range	0.00 to 45.00 ppm (mg/L); 0.0 to 300.0 % saturation
	Resolution	0.01 ppm (mg/L); 0.1 % saturation
	Accuracy	± 1.5% of reading ±1 digit
	Calibration	one or two-point at 0% (HI7040 solution) and 100% (in air)
	Temperature Compensation	ATC (0 to 50°C; 32.0 to 122.0°F)*
	Salinity Compensation	0 to 40 g/L (with 1 g/L resolution)
	Altitude Compensation	-500 to 4000 m (-1640 to 13120') (with 100 m (328') resolution)
Temperature	Range*	-20.0 to 120.0°C; -4.0 to 248.0°F
	Resolution	0.1°C; 0.1°F
	Accuracy	±0.5°C; ±0.9°F
Additional Specifications	Probe	HI764080 digital dissolved oxygen electrode with 3.5 mm (1/8") connector and 1 m (3.3') cable (included)
	Logging	up to 1000 records organized in: manual log-on-demand (max. 200 logs), manual log-on-stability (max. 200 logs), interval logging (max. 600 samples; 100 lots)
	Connectivity	1 USB port for storage; 1 micro USB port for charging and PC connectivity
	Environment	0 to 50°C (32 to 122°F); RH max 95% non-condensing
	Power Supply	5 VDC adapter (included)
	Dimensions	202 x 140 x 12 mm (7.9" x 5.5" x 0.5")
Weight	250 g (8.82 oz.)	
Ordering Information	<p><b>HI2004-01</b> (115V) and <b>HI2004-02</b> (230V) edge DO includes: HI764080 dissolved oxygen electrode, HI7041S refill electrolyte solution, DO membrane caps (2), o-rings (2), benchtop docking station with electrode holder, wall-mount cradle, USB cable, 5 VDC power adapter, quality certificates and instruction manual.</p> <p><b>HI2004-03</b> includes the above without electrode.</p>	

\* temperature limits will be reduced to actual probe limits

\*\* with temperature compensation function disabled

† standard mode only

HI98198

# Optical Dissolved Oxygen Meter

Professional dissolved oxygen measurement with digital optical probe

## Design Features

- Digital optical probe with Quick Connect
- IP67 rated waterproof, rugged enclosure
- Clear, dot matrix, back-lit display with multifunction virtual keys
- A dedicated HELP key for assistance anytime.

## Technical Features

- Percent saturation or concentration measurements (mg/L)
- One or two-point calibration at 0 or/and 100% saturation (with auto recognition).
- Automatic temperature compensation with one-point temperature calibration
- Salinity compensation
  - Salinity compensation allows for direct determination of dissolved oxygen in saline waters.
  - Users can set the salinity value
- A user selectable "Calibration due" warning.
- Built-in calculations
  - Biochemical Oxygen Demand (BOD), Oxygen Uptake Rate (OUR) and Specific Oxygen Uptake Rate (SOUR) modes
- Built-in barometer
  - Automatic barometric pressure compensation with 1 point calibration
  - Displays pressure in user-selectable units (mmHg, inHg, atm, psi, kPa, mbar)
- Log on demand with 4000 records capability.
- AutoEnd freezes the next stable measurement value on the display.
- GLP
  - A dedicated GLP key that includes at last 5 calibrations with time, date, calibration points as well as barometric pressure, temperature and salinity setting.
- USB-C port for easy data transfer to memory stick, PC or other compatible device
- Displays temperature in °C or °F
- Approximately 200 hours of continuous use using 4 AA batteries



The HI98198 opdo™ meter is a rugged, portable dedicated dissolved oxygen (DO) meter designed for fresh and saltwater measurements of dissolved oxygen. This professional, waterproof meter complies with IP67 standards and measures DO, barometric pressure, and temperature. The HI98198 is supplied with a HI764113 digital optical dissolved oxygen probe in a custom thermoformed durable carrying case with accessories. It is compact and ergonomically designed to provide ready access to the materials required for routine sampling.

The HI98198 opdo meter is only compatible with the Hanna HI764113 digital dissolved oxygen probe.

Concentration measurements are automatically compensated for barometric pressure, temperature and salinity. Barometric pressure and temperature are automatically measured and compensated. Salinity is automatically compensated by setting manually the salinity concentration of the water being measured. The meter also has a built in application to measure and calculate BOD (Biological Oxygen Demand), OUR (Oxygen uptake rate), and SOUR (Specific Oxygen Update Rate).

## Features in Detail



### Backlit graphic LCD display

The HI98198 features a backlit graphic LCD with on-screen help and battery life indicator. Dissolved oxygen, barometric pressure, and temperature readings can be displayed in user preferred units. The graphic display allows the use of virtual keys to enhance the intuitive user interface. The meter also displays a text reminder when a scheduled calibration is due.

### Waterproof protection

The meter is enclosed in an IP67 rated waterproof casing and can withstand immersion in water at a depth of 1m for up to 30 minutes.



### Quick connections to probes

The HI98198 meter is compatible with the HI764113 Optical dissolved oxygen probe. Connections are facilitated by the Quick Connect 7-pin DIN connector which makes attaching and removing the probe quick and easy. The meter automatically detects the connected probe.



### Measurement

The HI98198 automatically compensates dissolved oxygen concentrations. Temperature and atmospheric pressure compensations are automatically made. Salinity compensation can be manually entered.

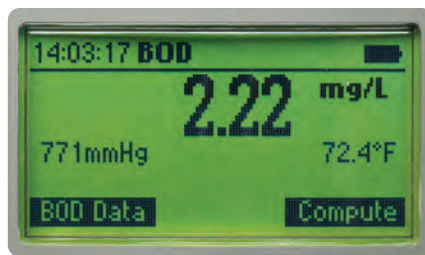

### BOD, OUR and SOUR

Dedicated measurement programs are available by using the Mode selection key.

### Built-in barometer

With the internal barometer, the HI98198 is able to compensate for changes in barometric pressure so there is no need for charts, altitude information or external barometric pressure information.

Pressure compensation with the meter's built-in barometer can be validated against a reference barometer, and if needed, can be recalibrated in user-selectable units (mmHg, inHg, atm, psi, kPa, mbar).



### Data logging

Log on demand with 4000 records capability.



### GLP

The last five sets of Calibration data are available by pressing the dedicated GLP key. Calibration values with time and date stamp are captured as well as pressure, salinity and temperature values at the time of calibration. GLP data is available on logged data.



### Data transfer

USB Type-C port for easy data transfer to memory stick, PC, or other compatible devices.



### Intuitive keypad

The fitted rubber keypad has dedicated keys for power, backlight, up/down arrows and help. The meter also features two virtual soft keys that navigate the user through the configuration, meter setup, and logging of data. The interface is intuitive for any user's level of experience.

### Dedicated help key

Access help at any time via the Help button and view content specific information based on the screen that is currently being viewed.

### AutoEnd

Press AutoEnd during measurement to hold the first stable reading on the display automatically.

## Theory

The Hanna HI764113 optical DO sensing probe is based on the principle of fluorescence quenching. The sensing method features an immobilized Pt based luminophore that is excited by the light of a blue LED and emits a red light. Dissolved oxygen quenches this excitation. When there is no oxygen present, the lifetime of the signal is the greatest; as oxygen hits the sensing surface, the lifetime becomes shorter. The intensity and lifetime are inversely proportional to the amount of oxygen present; as oxygen interacts with the luminophore it reduces the intensity and lifetime of the luminescence. The lifetime of the luminescence is measured by a photodetector, and is used to calculate the dissolved oxygen concentration. This is in turn reported by the meter as a % saturation or mg/L reading of Dissolved Oxygen.

The major components of the probe include a blue LED for excitation, a red LED that is used as a reference light, and a photodetector. The Smart Cap™ is locked in place on the optical probe and includes the immobilized O<sub>2</sub> sensitive luminophore with rugged insoluble black oxygen permeable protective layer.

Over time, the sensor's optical components can age but are compensated for by using the reference signal to compensate the measuring path. As a result, the sensor provides accurate DO measurements over long periods of time without the need for frequent calibration.

### Specifications

### HI98198

Dissolved Oxygen	Range	0.00 to 50 mg/L (ppm); 0.0 to 500.0% saturation
	Resolution	0.01 mg/L (ppm); 0.1% saturation
	Accuracy (@25°C/77°F)	1.5% of reading ± 0.01mg/L for 0.00-20.00mg/L; 5% of reading for 20.00-50.00mg/L; 1.5% of reading ±0.1% for 00-200.0%; 5% of reading for 200.0-500.0%
	Calibration	one or two points automatic calibration at 100% (8.26 mg/L) and 0% (0 mg/L); Single point manual using a value entered by the user in % saturation or mg/L
Barometric Pressure	Range	420 to 850 mmHg
	Resolution	1 mmHg
	Accuracy (@25°C/77°F)	±3 mmHg within ±15% from the calibration point
	Calibration	single point anywhere within pressure range
Temperature	Range	-5.0 to 50.0°C (23 to 122°F)
	Resolution	0.1°C (0.1°F)
	Accuracy (@25°C/77°F)	±0.3°C (±0.4°F)
	Calibration	single point anywhere within temperature range
Additional Specifications	Temperature Compensation	automatic from -5.0 to 50.0°C (23.0 to 122.0°F)
	Pressure Compensation	automatic from 420 to 850 mmHg
	Salinity Compensation	automatic from 0 to 70 PSU (manually set)
	Probe	HI764113 optical DO probe with stainless steel, weighted protective sleeve, internal temperature sensor, 7-pin DIN connector and 4m (13') cable (included)
	Logging	On demand with 4000 records capability
	Battery Type / Life	1.5V (4) AA batteries / approximately 200 hours of continuous use without backlight (50 hours with backlight)
	Auto-off	user-selectable: 5, 10, 30, 60 min or disabled
	PC Connectivity	USB Type-C
	Dimensions	185 x 93 x 35.2 mm (7.3 x 3.6 x 1.4")
	Weight (with batteries)	450 g (15.9 oz.)
	Case Ingress Protection Rating	IP67
	Environment	0 to 50 °C (32 to 122 °F) max. RH 100%

### Ordering Information

**HI98198** is supplied with HI764113 Optical DO probe with built-in temperature sensor, protective shield and 4 m (13.1') cable, HI764113-1 Smart Cap™ with o-ring, HI7040 Bicomponent Zero Oxygen Solution, Calibration/storage vessel, 100 mL plastic beaker (2), 1 syringe with silicon grease, 1 lens wipe, 1.5V AA batteries (4), Instruction manual, meter quality certificate, probe quality certificate, cap quality certificate, HI920016 USB Type A to C cable in a rugged carrying case.

**HI98198/10** is supplied with HI764113/10 Optical DO probe with built-in temperature sensor, protective shield and 10 m (32.8') cable, HI764113-1 Smart Cap™ with o-ring, HI7040 Bicomponent Zero Oxygen Solution, Calibration/storage vessel, 100 mL plastic beaker (2), 1 syringe with silicon grease, 1 lens wipe, 1.5V AA batteries (4), Instruction manual, meter quality certificate, probe quality certificate, cap quality certificate, HI920016 USB Type A to C cable in a rugged carrying case.

### Accessories

**HI710034** orange protective rubber boot  
**HI720198** spare carrying case for HI98198

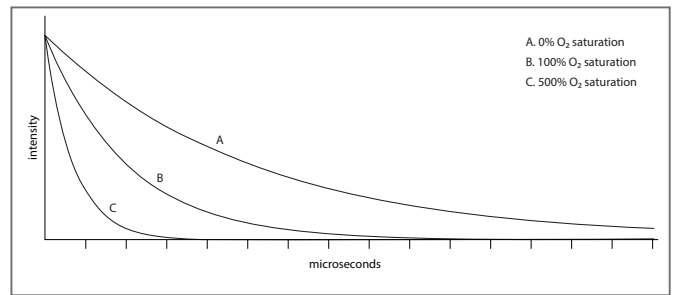

Luminescence emissions of three oxygen measurements after pulsed blue light excitation.



- Optional shockproof silicon rubber boot
  - Specially designed to protect your instrument from damage or impact

**HI710034** Orange



### Rugged custom carrying case

The HI98198 meter, probe, and all accessories are supplied in a rugged carrying case designed to provide years of use. The inside compartment of the carrying case is thermoformed to securely hold and protect all of the components.



# Rugged Optical Dissolved Oxygen Probe for Fresh and Saltwater Applications

- Digital, weighted probe
- No membranes
- No electrolytes
- No oxygen consumption
- No flow dependence or minimum flow rate
- Fast and stable readings
- Not affected by sunlight
- Factory calibrated "Smart Cap"
- Smart Caps last one year
- Minimal maintenance



Alignment key

**HI764113 optical DO probe**  
The IP68 rated waterproof ABS probe contains circuit, photodetector, and excitation and reference LEDs.

HI764113-1 Smart Cap

Stainless steel, weighted protective guard

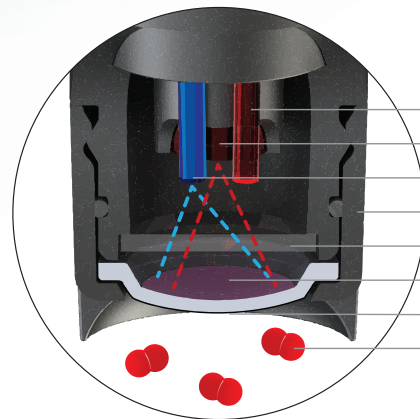

### Sensor

- Red light: reference source
- Photodetector
- Blue light: excitation source
- Smart cap
- Optical window
- Fluorescent luminophore
- Black protective layer
- Oxygen molecules

Specifications	HI764113
Probe body material	ABS
Smart Cap™ material	Polypropylene
Cable jacket material	PVC
Cable length	4 m (13.1 ft.), 10 m (32.8 ft.), and 20 m (65.6 ft.) options
Probe guard	316 Stainless Steel
Temperature Measurement	Thermistor
Pressure	20 m (29 PSI)
Probe Dimensions (with Guard)	174 X 25 mm (6.8 X 1")
Response Time (t95)	45 seconds
Probe Weight (with Guard)	400 g (14.2 oz); 4 m (13.1 ft.) cable length
Probe Ingress Protection Rating	IP68
Sensor type	Optical; Luminescence Quenching

## Smart Cap

RFID tag



Smart Cap with RFID communication stores factory calibration coefficients.



The domed surface helps repel surface bubbles and provides increased luminophore surface area for better measurement sensitivity.

HI98193

# Professional Waterproof Meters

*Dissolved Oxygen and BOD*

- **Waterproof**
  - IP67 rated waterproof, rugged enclosure
- **Choice of units**
  - Display units in % saturation or mg/L (ppm)
- **Salinity compensation**
  - Salinity compensation allows for direct determination of dissolved oxygen in saline waters.
  - Users can set the salinity value
- **Built-in temperature sensor**
  - Automatic temperature compensation with one or two-point temperature calibration
  - Displays temperature in °C or °F
- **Built-in barometer**
  - Automatic barometric pressure compensation with 1 point calibration
  - Displays pressure in user-selectable units (mmHg, inHg, atm, psi, kPa, mbar)
- **Built-in calculations**
  - Determination of Biochemical Oxygen Demand (BOD), Oxygen Uptake Rate (OUR) and Specific Oxygen Uptake Rate (SOUR)
- **Polarization**
  - Automatic polarization of probe at startup
- **Membrane caps**
  - Ready-to-use preformed PTFE membrane caps
- **200 hour battery life**
  - Approximately 200 hours of continuous use
- **Clear display**
  - Dot matrix display with multifunction virtual keys
- **AutoHold**
  - Automatically holds the first stable reading on the display
- **Calibration timeout**
  - Alerts when calibration is due at a specified interval
- **PC Connectivity**
  - PC connectivity via opto-isolated micro-USB with HI92000 software
- **Log-on-demand**
  - Store measurement data at the press of a button
- **GLP**
  - GLP data provides calibration data including date, time, pressure, calibrated value, temperature and salinity value of the last calibration



## For Universal Applications

The HI98193 is a portable DO meter with extended ranges of up to 50 ppm and 600% saturation. HI98193 features compensations for pressure, temperature and salinity, which are essential for an accurate dissolved oxygen reading. HI98193 is supplied with the HI764073 polarographic dissolved oxygen probe that utilizes field replaceable PTFE membrane caps.



- **Optional shockproof silicon rubber boot**
  - Specially designed to protect your instrument from damage or impact

**HI710034** Orange



### Backlit Graphic LCD Display

The HI98193 features a backlit graphic LCD with on-screen help. The graphic display allows for the use of virtual keys to provide for an intuitive user interface.

### Waterproof Protection

The meter is enclosed in an IP67 rated waterproof casing and can withstand immersion in water at a depth of 1 m for up to 30 minutes. The probe features an IP68 rating for continuous immersion in water.



### Quick connect probe

The HI764073 DO probe features a quick connect DIN connector to make attaching and removing the probe simple and easy.

The HI764073's built-in temperature sensor allows for automatic temperature compensation. The temperature sensor can be calibrated to one or two points. Manual entry of salinity values allows for the salinity compensation of dissolved oxygen readings in saline waters.

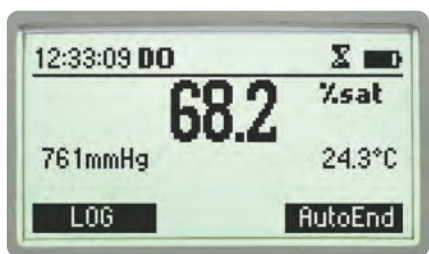

### Measurement

The HI98193 has extended ranges of up to 50 ppm and 600% saturation. When measuring dissolved oxygen, compensations for salinity, temperature and pressure are essential to improve the accuracy and precision of readings.

### BOD, OUR and SOUR

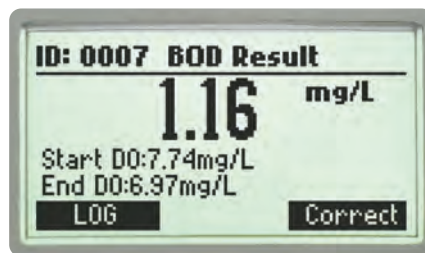

- **BOD results**
  - BOD is calculated in mg per liter from the difference between the initial and final dissolved oxygen

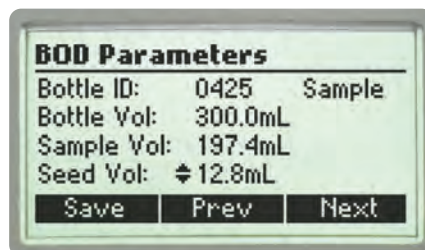

- **BOD parameters and records**
  - All necessary parameters for BOD testing can be set and displayed at once.
  - A list of all saved BOD data can be easily retrieved and shown on the LCD display.

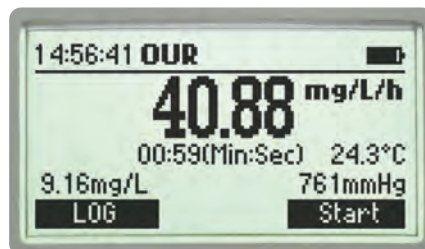

- **OUR results**
  - Measured in mg of oxygen consumed per L per hour.

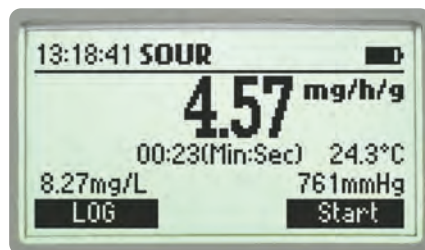

- **SOUR results**
  - Measured in mg of oxygen consumed per g of volatile suspended solids per hour.

### AutoHold

Pressing AutoHold during measurement will automatically hold the first stable reading on the display.

### Built-in Barometer

With the internal barometer, the HI98193 is able to compensate for changes in barometric pressure so there is no need for charts, altitude information or external barometric pressure information.

Pressure compensation with the meter's built-in barometer can be validated against a reference barometer, and if needed, can be recalibrated in user-selectable units (mmHg, inHg, atm, psi, kPa, mbar).



### Data Logging

The HI98193's log on-demand feature allows users to store up to 400 readings. This data can then be transferred to a PC with the HI920015 USB cable and HI92000 software.

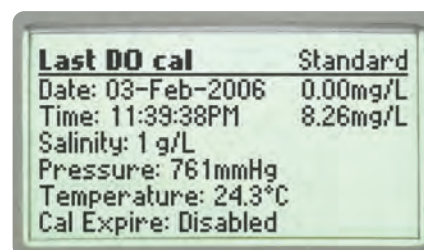

### GLP

Comprehensive GLP functions are directly accessible by pressing the GLP key. This data includes date, time, pressure, calibrated value, temperature and salinity value of the last calibration.

### Intuitive Keypad

The fitted rubber keypad has dedicated keys for power, backlight, up/down arrows, help and alphanumeric characters. The meter also features two virtual soft keys that navigate the user through the configuration of each parameter, meter setup, and logging of data. The interface is intuitive for any user's level of experience.

### Dedicated Help Key

Access help at any time at the press of a dedicated button and view content specific information based on the screen that is currently being viewed.

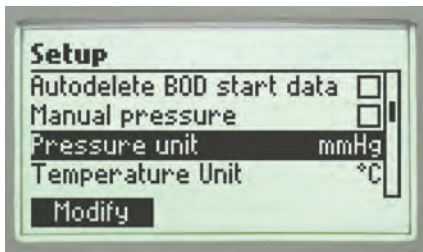

### Setup screen

Our extensive setup screen features a host of configurable options such as time, date, temperature units and language for help screens and guides



### PC Connectivity

Logged data can be transferred to a Windows compatible PC with the included HI920015 micro USB cable and HI92000 software.

### Long Battery Life

The display of the meter has a battery icon indicator to show the remaining power. The meter uses four 1.5V AA batteries that provide up to 200 hours of battery life.



### Rugged custom carrying case

The HI98193 meter, probe, and all accessories are supplied in the HI720193 rugged carrying case designed to provide years of use. The inside compartment of the carrying case is thermoformed to securely hold and protect all of the components.



Specifications	HI98193	
Dissolved Oxygen	Range	0.00 to 50.00 mg/L (ppm); 0.0 to 600.0% saturation
	Resolution	0.01 mg/L (ppm); 0.1% saturation
	Accuracy (@25°C/77°F)	±1.5% of reading ±1 digit
	Calibration	automatic one or two point at 100 % (8.26 mg/L) and 0 % (0 mg/L); manual one point using a value entered by the user in % saturation or mg/L
Atmospheric Pressure	Range	450 to 850 mmHg
	Resolution	1 mmHg
	Accuracy (@25°C/77°F)	± 3 mmHg within ±15% from the calibration point
	Calibration	one point at any in range pressure value
Temperature	Range	-20.0 to 120.0°C; -4.0 to 248.0°F
	Resolution	0.1°C; 0.1°F
	Accuracy (@25°C/77°F)	±0.2°C; ±0.4°F (excluding probe error)
	Calibration	one or two point at any in range temperature value
Additional Specifications	Measurement Modes	direct DO; BOD (biochemical oxygen demand); OUR (oxygen uptake rate); SOUR (specific oxygen uptake rate)
	Barometric Compensation	automatic from 450 to 850 mmHg
	Salinity Compensation	automatic from 0 to 70 g/L
	Temperature Compensation	automatic from 0.0 to 50.0 °C (32.0 to 122.0 °F)
	Probe	HI764073 polarographic DO probe with protective sleeve, internal temperature sensor, DIN connector and 4m (13') cable (included)
	Logging	log-on-demand up to 400 samples
	PC Connectivity	opto-isolated USB (with HI92000 software)
	Battery Type / Life	1.5V (4) AA batteries / approximately 200 hours of continuous use without backlight (50 hours with backlight)
	Auto-off	user-selectable: 5, 10, 30, 60 min or can be disabled
	Environment	0 to 50°C (32 to 122°F); RH 100% IP67
Dimensions	185 x 93 x 35.2 mm (7.3 x 3.6 x 1.4")	
Weight	400 g (14.2 oz.)	
Ordering Information	All meters are supplied with: HI7040 bi-component zero oxygen solution (230 mL + 30 mL), HI7041S electrolyte solution (30 mL), preformed PTFE membrane caps (2), DO protective cap, O-rings (2), 100 mL plastic beaker (2), HI92000 PC software, HI920015 micro USB cable, 1.5V AA batteries (4), quick start guide, quality certificate and instruction manual in an HI720193 rugged carrying case with custom insert. <b>HI98193</b> is supplied with HI764073 polarographic DO probe with protective sleeve and 4m (13') cable. <b>HI98193/10</b> is supplied with HI764073/10 polarographic DO probe with protective sleeve and 10m (33') cable.	
	Accessories	<b>HI710034</b> orange protective rubber boot

HI9147

## Dissolved Oxygen Meter for Aquaculture

- Automatic Temperature Compensation (ATC)
- Waterproof
- Backlit LCD

The HI9147 is designed for aquaculture applications. This unit is unique among our family of DO meters as it is supplied with a galvanic probe.

Unlike polarographic probes, galvanic DO probes require no conditioning time. When you need to measure multiple samples in a given period of time, simply turn the meter on and start taking measurements.

The HI9147 is a must have for DO sensitive organisms or high bio-load environments.

### DO Levels at 100% Saturation

	Salinity (ppt)				
Temperature	0	10	20	30	40
10°C / 50°F	13.0	12.2	11.4	10.6	9.8
15°C / 59°F	10.3	9.7	9.2	8.6	8.1
20°C / 68°F	9.4	8.8	8.4	7.9	7.4
25°C / 77°F	8.5	8.0	7.6	7.2	6.7
30°C / 86°F	7.8	7.4	7.0	6.6	6.2



#### Specifications

#### HI9147

Dissolved Oxygen	Range	0.0 to 50.0 mg/L (ppm); 0 to 600% saturation
	Resolution	0.1 mg/L (ppm); 1% saturation
	Accuracy (@25°C/77°F)	±1% of reading
Temperature	Range	-5.0 to 50.0°C; 23.0 to 122.0°F
	Resolution	0.1°C; 1°F
	Accuracy (@25°C/77°F)	±0.2°C; ±1°F (excluding probe error)
Additional Specifications	Calibration	manual, in saturated air
	Temperature Compensation	automatic, 0° to 50°C (32°F to 122°F)
	Altitude Compensation	0 to 4000 m (resolution 100 m)
	Salinity Compensation	0 to 51 g/L (ppt) (1 g/L resolution)
	Probe	HI76409/4 galvanic DO probe (fixed) with internal temperature sensor, DIN connector and 4 m (13') cable (HI9147-04), 10 m (33') cable (HI9147-10), or 15 m (49') cable (HI9147-15)
	Battery Type / Life	1.5V AAA (3) / approx. 1000 hours of continuous use without backlight
	Environment	0 to 50°C (32 to 122°F); RH max 95% non-condensing
	Dimensions / Weight	185 x 72 x 36 mm (7.3 x 2.8 x 1.4") / 450 g (15.9 oz.)
Ordering Information	<p><b>HI9147-04</b> is supplied with HI76409/4 probe with 4 m (13') cable, spare membranes (5), electrolyte solution (30 mL), batteries, screwdriver and instructions.</p> <p><b>HI9147-10</b> is supplied with HI76409/10 probe with 10 m (32.8') cable, spare membranes (5), electrolyte solution (30 mL), batteries, screwdriver and instructions.</p> <p><b>HI9147-15</b> is supplied with HI76409/15 probe with 15 m (49.2') cable, spare membranes (5), electrolyte solution (30 mL), batteries, screwdriver and instructions.</p>	

HI9146

## Dissolved Oxygen Meter

Dissolved oxygen is a commonly measured parameter in aquaculture, wastewater treatment, environmental studies, and wine analysis. The HI9146 is a rugged, portable dissolved oxygen (DO) meter designed to provide high accuracy measurements whether in the field or in the lab. The meter features automatic calibration performed at one or two points in saturated air and/or zero oxygen solution. All readings are automatically compensated for temperature variations and can be frozen on the display upon stability using the auto-end feature. Salinity and altitude compensation are user adjustable based on the environmental conditions that are present. The HI9146 features a Battery Error Prevention System (BEPS) that detects when the batteries become too weak to ensure reliable measurements. The HI9146 is supplied complete and ready to use.

- Polarographic Measuring System
- Replaceable Membrane Caps
- Automatic Calibration
- Good Laboratory Practice (GLP)
- Automatic Temperature Compensation
- Altitude Compensation
- Salinity Compensation
- Auto End Point
  - The HI9146 features an auto endpoint mode in which when selected the reading will frozen on the display once a stable measurement is obtained. The auto-end feature allows for consistency among various users by ensuring that stability has been achieved before recording a measurement.
- Backlit LCD
- Battery Error Prevention System (BEPS)
  - The Battery Error Prevention System detects when the batteries become too weak to ensure reliable measurements. The backlight feature is automatically disabled when batteries are getting low and a clear indication is displayed to warn the user of this condition.



### Specifications

### HI9146

DO	Range	0.00 to 45.00 mg/L (ppm); 0.0 to 300.0% saturation
	Resolution	0.01 mg/L (ppm); 0.1% saturation
	Accuracy (@ 25°C/77°F)	±1.5% F.S. or ±1 digit, whichever is greater
Temperature	Range	0.0 to 50.0°C; 32.0 to 122.0°F
	Resolution	0.1°C; 0.1°F
	Accuracy (@ 25°C/77°F)	±0.2°C; ±0.4°F (excluding probe error)
Additional Specifications	Dissolved Oxygen Calibration	one or two points at 0% (HI7040 solution) and 100% (in air)
	Temperature Compensation	automatic from 0 to 50°C (32 to 122°F)
	Altitude Compensation	0 to 4000 m (resolution 100 m)
	Salinity Compensation	0 to 80 g/L (ppt) (resolution 1 g/L)
	Probe	HI76407/4F polarographic DO probe, internal temperature sensor, DIN connector and 2 m (6.6') cable (included)
	Battery Type / Life	1.5V AAA (3) /approximately 200 hours of continuous use without backlight (50 hours with backlight on)
	Environment	0 to 50°C (32 to 122°F); RH max 95%
Dimensions	185 x 72 x 36 mm (7.3 x 2.8 x 1.4")	
Weight	300 g (10.6 oz.)	

### Ordering Information

**HI9146-04** is supplied complete with HI76407/4F probe with 4 m (13.1') cable, HI76407A membranes (2), HI7041S electrolyte solution (30 mL), batteries, instructions and rugged carrying case.

**HI9146-10** is supplied complete with HI76407/10F probe with 10 m (32.8') cable, HI76407A membranes (2), HI7041S electrolyte solution (30 mL), batteries, instructions and rugged carrying case.



HI9142

## Manual Calibration Dissolved Oxygen Meter

- Automatic Temperature Compensation (ATC)
- One or two-point calibration
- Waterproof

The ever increasing demand for instant on-site analysis results has created a need for innovative, rugged, portable and waterproof meters.

Field work can subject instrumentation to the inclemency of weather. Cold, rain, snow, dust and humidity can cause condensation to breach the housing. Once the housing has been compromised, the meter is susceptible to diminishing performance and life span. The rugged, waterproof housing of the HI9142 solves many of the problems of field use.

Calibration is performed with HI7040 zero oxygen solution, while 100% calibration is done in air.

The polarographic probe (HI76407/4) is accurate to 0.3 ppm and is supplied with a 4 m (13') cable that allows measurements to be taken even in hard to reach places.

### Specifications

### HI9142

Dissolved Oxygen	Range	0.0 to 19.9 mg/L (ppm)
	Resolution	0.1 mg/L (ppm)
	Accuracy (@ 25°C/77°F)	±1.5% F.S.
Temperature	Range	-5.0 to 50.0°C (23.0 to 122.0°F)
	Resolution	0.1°C (1°F)
	Accuracy (@ 25°C/77°F)	±0.2°C (±1°F) (excluding probe error)
Additional Specifications	Calibration	automatic in zero oxygen solution; manual in 100% water saturated air
	Temperature Compensation	automatic, 0 to 50°C (32 to 122°F)
	Probe	HI76407/4 polarographic DO probe with internal temperature sensor, DIN connector and 4 m (13') cable
	Battery Type / Life	1.5V AAA (3) / approximately 1,000 hours of continuous use
	Environment	0 to 50°C (32 to 122°F); RH max 100%
	Dimensions	185 x 72 x 36 mm (7.3 x 2.8 x 1.4")
	Weight	300 g (10.6 oz.)
Ordering Information	<b>HI9142</b> is supplied with HI 76407/4 probe with 4 m (13') cable, 2 spare membranes, HI7041S electrolyte solution (30 mL), calibration screwdriver, batteries, instructions and rugged carrying case.	

HI764113 • HI7641133

## Optical DO Probe

- Digital, weighted probe
- No membranes
- No electrolytes
- No oxygen consumption
- No flow dependence or minimum flow rate
- Fast and stable readings
- Not affected by sunlight
- Factory calibrated "Smart Cap"
- Smart Caps last one year
- Minimal maintenance

- 1 Strain relief
- 2 ABS Probe body
- 3 Temperature Sensor
- 4 O-Ring Seal
- 5 Optical window
- 6 Alignment key
- 7 Smart Cap™
- 8 RFID Tag
- 9 Embedded O<sub>2</sub> sensitive luminophore with black protective layer
- 10 Protective shield\*

Probe	Cable Length	Required Meter
HI7641133*	1 m (3.3')	HI6421
HI764113	2 m (6.6')	HI98198
HI764113/10	10 m (33')	
HI764113/20	20 m (33')	

\* HI7641133 for the HI6421 does not include a protective shield.

## Accessories

HI764113-1	Smart Cap with O-ring
HI764113-2	Calibration/Storage vessel
HI764113-3	Stainless Steel Protective Shield

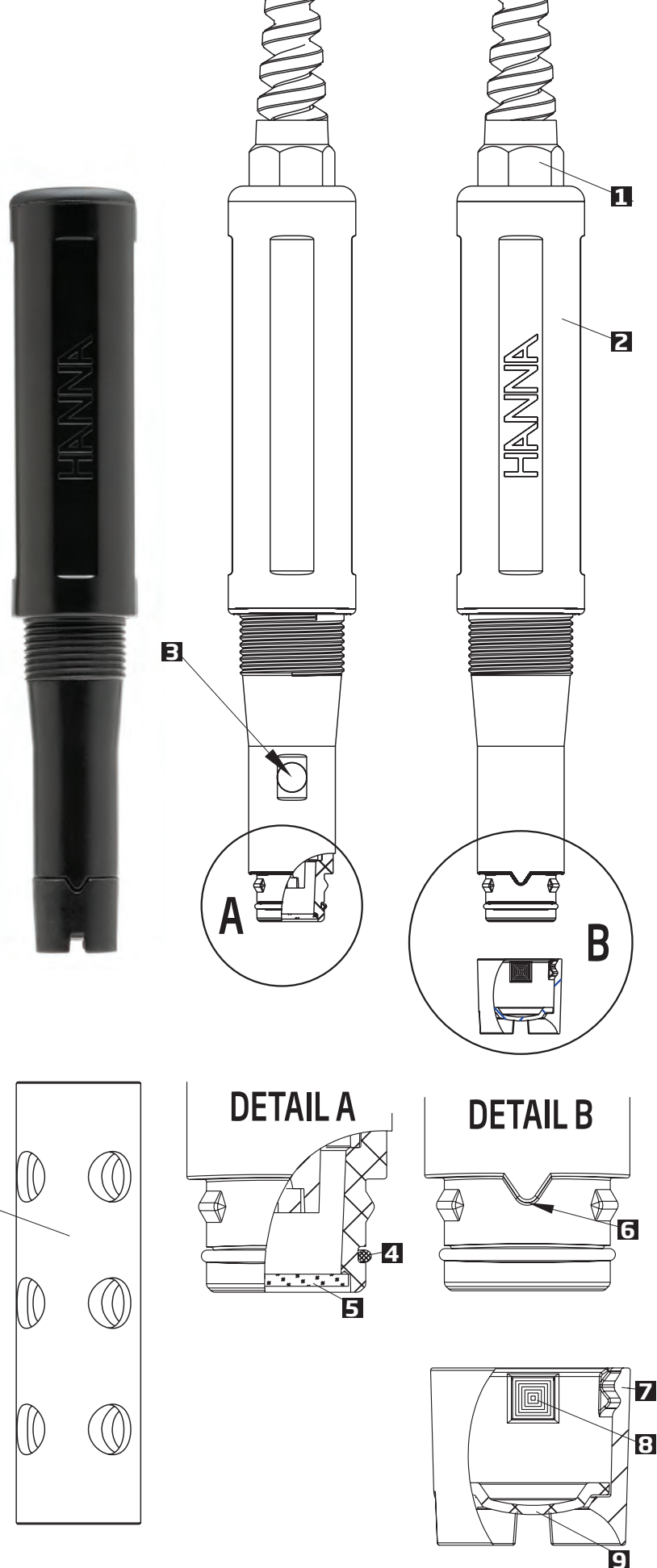





HI764113 with HI764113-3 stainless steel protective shield attached



HI764113 with HI764113-2 calibration/storage vessel attached

## Smart Cap

RFID tag



Smart Cap with RFID communication stores factory calibration coefficients.



The domed surface helps repel surface bubbles and provides increased luminophore surface area for better measurement sensitivity.

HI764080

## edge® Compatible Digital DO Probe

The HI 764080 is a digital dissolved oxygen electrode with built-in temperature sensor. This ultra-thin, Clark-type polarographic electrode is designed for measuring DO in aqueous solutions and contains a built-in microchip that stores sensor type, serial number, and calibration information. The sensor features a platinum cathode with a silver/silver chloride anode, an integrated temperature sensor, and easily replaceable PTFE membrane caps. The HI 764080 is designed for use with Hanna's edge® pH/EC/DO meter.

- Digital Microprocessor
- Ultra-thin design - 12mm body for convenience
- Replaceable membranes - easy screw on for easy maintenance
- Polarographic sensor
- Built-in temperature sensor
- 3.5mm digital plug - easy to plug in, no alignment necessary

- 1** Strain relief
- 2** Probe cap
- 3** PEI probe body
- 4** Temperature sensor
- 5** Threads for membrane cap
- 6** Ag/AgCl anode and reference
- 7** Glass insulator
- 8** Platinum cathode
- 9** Disposable membrane cap
- 10** Oxygen permeable PTFE membrane

Probe	Cable Length	Compatible edge™ meters
HI764080	1 m (3.3')	HI2020 HI2030 HI2040 HI2004

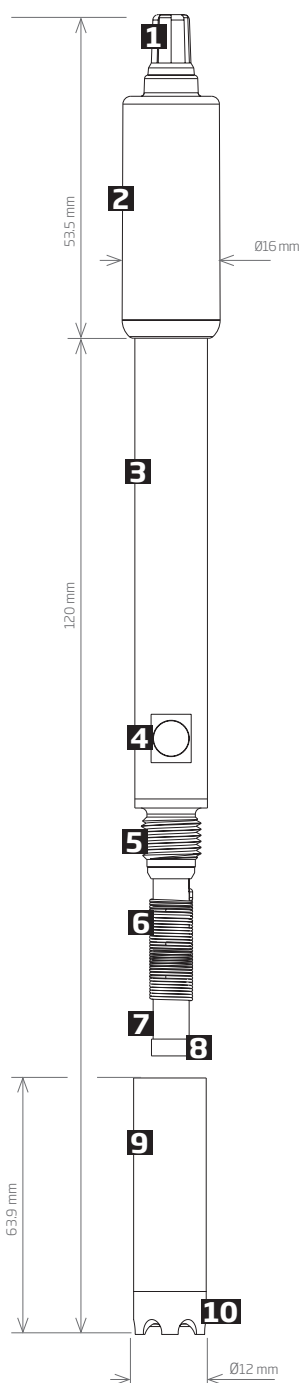

HI764080A/P

## Easy, Screw Cap DO Membranes



When the PTFE (polytetrafluoroethylene) membrane of the protective cap wears, it is always good to have a back-up.

HI764080A/P

Contains 5 ready-to-use, replacement membranes

HI7041

## Electrolyte Solution



It is crucial to the performance of your DO probe to keep the sensor active with regular maintenance. For this purpose, Hanna has developed HI7041 electrolyte solution to refill the membrane cap.

**HI7041S** refilling electrolyte solution (30 mL)

**HI7041M** refilling electrolyte solution (250 mL)

**HI7041L** refilling electrolyte solution (500 mL)

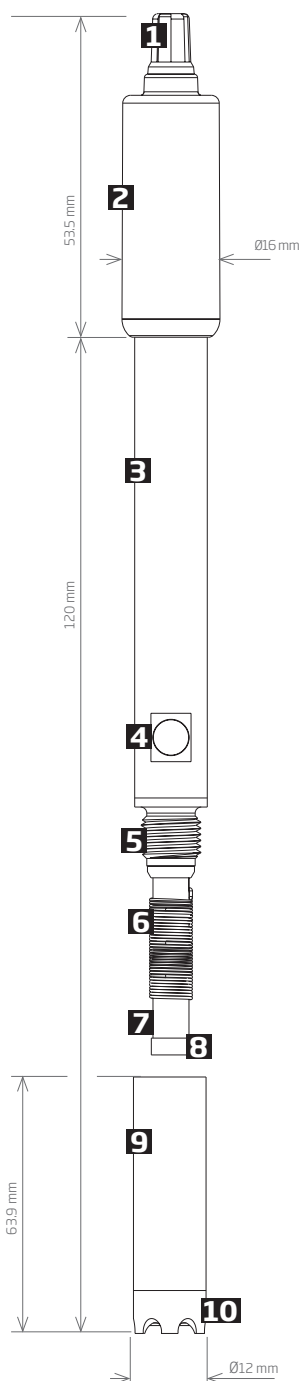

HI76483

## Polarographic DO Probe

The HI76483 Clark-Type Polarographic probe measures a wide range of dissolved oxygen from 0.0 to 600% saturation and 0.00 to 90.00 mg/L (ppm). The HI76483 has a slim design measuring only 12 mm in diameter and has a built-in thermistor temperature sensor that compensates for temperature variations from 0 to 50°C. The HI76483 is a spare DO probe for use with the HI5421 Laboratory Research Grade Benchtop Dissolved Oxygen and BOD Meter.

- Polarographic DO probe with analog signal
- 12 mm design that incorporates integral temperature
- Durable PEI (polyetherimide) body and membrane cap has outstanding chemical resistance
- Incorporated 1 m cable and DIN connector

- 1** Strain relief
- 2** Probe cap
- 3** PEI probe body
- 4** Temperature sensor
- 5** Threads for membrane cap
- 6** Ag/AgCl anode and reference
- 7** Glass insulator
- 8** Platinum cathode
- 9** Disposable membrane cap
- 10** Oxygen permeable PTFE membrane

Probe	Cable Length	Recommended meters
HI764833	1 m (3.3')	HI6421
HI76483	1 m (3.3')	HI5421

HI76483A/P

## Easy, Screw Cap DO Membranes



When the PTFE (polytetrafluoroethylene) membrane of the protective cap wears, it is always good to have a back-up.

HI76483A/P

Contains 5 ready-to-use, replacement membranes

HI7041

## Electrolyte Solution

It is crucial to the performance of your DO probe to keep the sensor active with regular maintenance. For this purpose, Hanna has developed HI7041 electrolyte solution to refill the membrane cap.



HI7041S	refilling electrolyte solution (30 mL)
HI7041M	refilling electrolyte solution (250 mL)
HI7041L	refilling electrolyte solution (500 mL)

HI76407 · HI764073 Protected Sleeve Series

## DO Probe

with Protective Sleeve

The HI76407/F is a standard Clark-type polarographic dissolved oxygen probe for Hanna's benchtop and portable dissolved oxygen meters. The probe is constructed of durable ABS plastic and contains an integrated temperature sensor for temperature compensated measurements. It is compatible with our HI76407A/P PTFE membrane caps. Each membrane separates the probe's platinum cathode and silver anode from the water sample being measured. Oxygen diffuses across the membrane and interacts with the polarographic system to produce a current proportional to oxygen concentration. Each cap is easily filled with HI7041 electrolyte and screwed on to the probe. The probe's protective sleeve makes it ideal for use in rugged or demanding environments.

- 1** Shielded, waterproof cable
- 2** Protective sleeve
- 3** PEI probe for best field protection
- 4** Linearized and accurate thermistor temperature sensor protected behind a stainless steel cover
- 5** Silver wire anode element
- 6** Glass encapsulated platinum cathode
- 7** Screw cap membrane that holds potassium chloride electrolyte solution (HI7041S)
- 8** Thin, permeable PTFE membrane isolates the sensor elements from the testing solution, but allows oxygen to enter (HI76407A/P)
- 9** Hole for solution cycling
- 10** Protective sleeve for field applications

HI76407A/P

### Easy, Screw Cap DO Membranes



When the PTFE (polytetrafluoroethylene) membrane of the protective cap wears, it is always good to have a back-up.

HI76407A/P

contains 5 ready-to-use, replacement membranes.

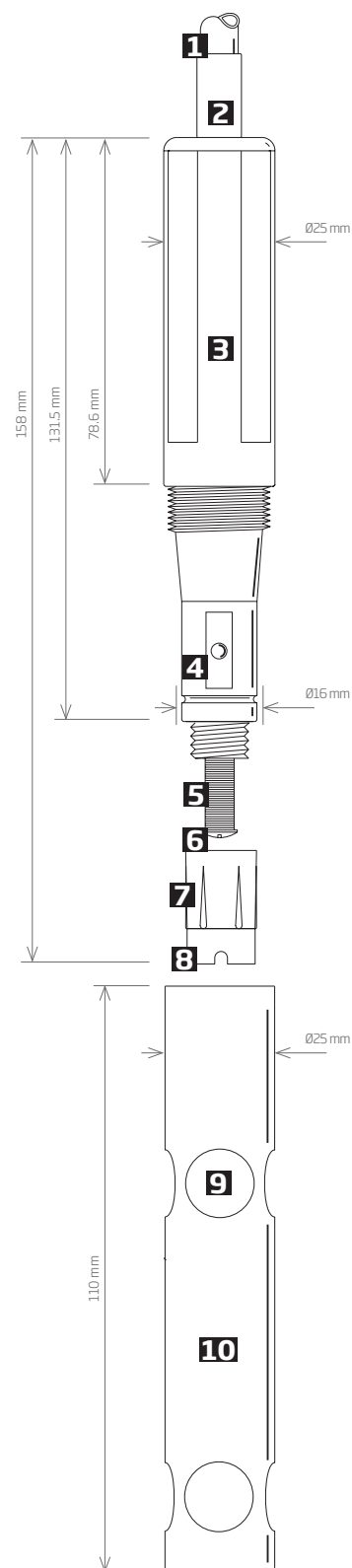

Probe	Cable Length	Recommended Meter
HI76407/4F	4 m (13')	HI9146
HI76407/10F	10 m (33')	
HI76407/20F	20 m (66')	
HI764073	4 m (13')	HI98193
HI764073/10	10 m (33')	

HI7040 · HI7041

### DO Solutions

It is crucial to the performance of your DO probe to keep the sensor active with regular maintenance.



HI7040L	zero oxygen solution set, 500 mL + 12g
HI7041S	refilling electrolyte solution (30 mL)
HI7041M	refilling electrolyte solution (250 mL)
HI7041L	refilling electrolyte solution (500 mL)

HI76409

## Galvanic DO Probe

with Protective Cap

The HI76409 is a standard galvanic dissolved oxygen probe for use with the HI9147 portable dissolved oxygen meter. Galvanic probes require no conditioning time and therefore allow the ability to measure instantaneously. With extreme portability and a straightforward design, this probe is ideal for both field and lab use.

The D.O. probe is provided with a membrane covering the galvanic sensors and a built-in thermistor for temperature measurement and compensation. The thin permeable membrane isolates the sensor elements from the testing solution but allows oxygen to enter. Oxygen that passes through the membrane causes a current flow, from which the oxygen concentration is determined.

- 1** Shielded, waterproof cable
- 2** Flex protect
- 3** Strain relief for cable
- 4** Temperature sensors
- 5** Zinc (Zn) anode
- 6** Ag<sup>+</sup> cathode (3.5 mm), pure silver
- 7** Protective cap

Probe	Cable Length	Recommended Meter
HI76409/4	4 m (13')	HI9147 (meter specific, fixed probe)
HI76409/10	10 m (33')	

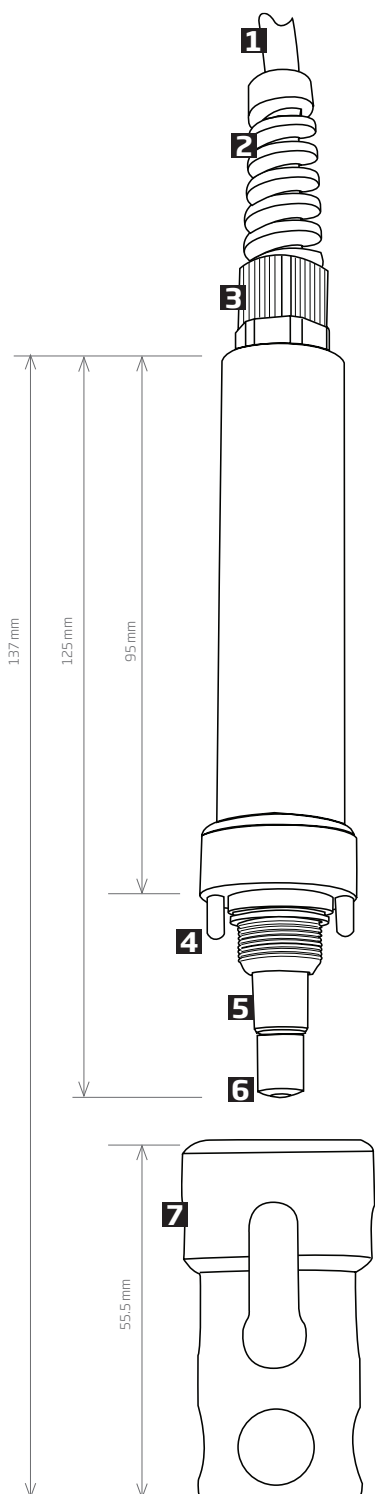

HI76409A/P

## Easy, Screw Cap DO Membranes

When the PTFE (polytetrafluoroethylene) membrane of the protective cap wears, it is always good to have a back-up.

**HI76409A/P** Contains 5 ready-to-use, replacement membranes



HI7040 • HI7042

## DO Solutions

It is crucial to the performance of your DO probe to keep the sensor active with regular maintenance.



**HI7040L** Zero oxygen solution set, 500 mL + 12g  
**HI7042S** Refilling electrolyte solution (30 mL)

HI76407

## Standard DO Probe

The HI76407 is a standard Clark-type polarographic dissolved oxygen probe for Hanna's benchtop and portable dissolved oxygen meters. The probe is constructed of durable ABS plastic and contains an integrated temperature sensor for temperature compensated measurements. It is compatible with our HI76407A/P PTFE membrane caps. Each membrane separates the probe's platinum cathode and silver anode from the water sample being measured. Oxygen diffuses across the membrane and interacts with the polarographic system to produce a current proportional to oxygen concentration. Each cap is easily filled with HI7041 electrolyte and screwed onto the probe. The probe's tapered design makes it ideal for BOD measurements.

- 1** Shielded, waterproof cable
- 2** Protective sleeve
- 3** PEI probe for best field protection
- 4** Linearized and accurate thermistor temperature sensor protected behind a stainless steel cover
- 5** Silver wire anode element
- 6** Glass encapsulated platinum cathode
- 7** Screw cap membrane that holds potassium chloride electrolyte solution (HI7041S)
- 8** Thin, permeable PTFE membrane isolates the sensor elements from the testing solution, but allows oxygen to enter (HI76407A/P)

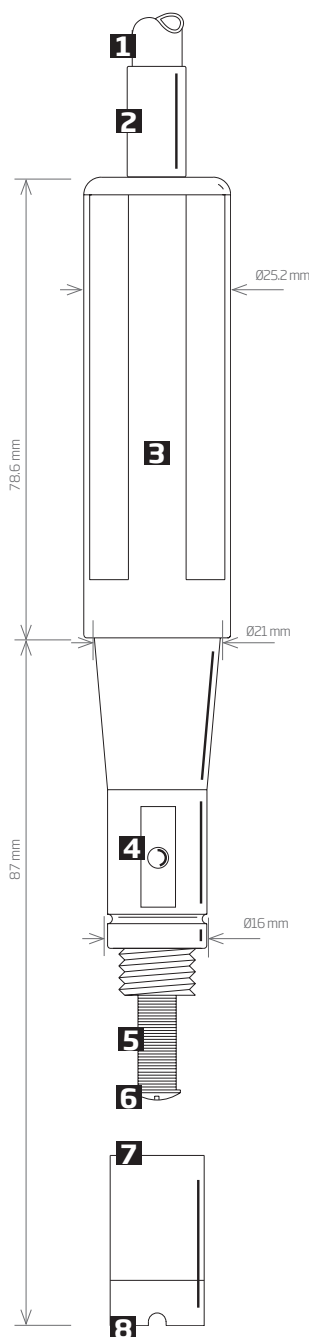

Probe	Cable Length	Recommended Meter
HI76407/2	2 m (6.6')	HI9142
HI76407/4	4 m (13')	
HI76407/10	10 m (33')	
HI76407/20	20 m (66')	

HI76407A/P

### Easy, Screw Cap DO Membranes



When the PTFE (polytetrafluoroethylene) membrane of the protective cap wears, it is always good to have a back-up.

**HI76407A/P** contains 5 ready-to-use, replacement membranes.

HI7041

### Electrolyte Solution



It is crucial to the performance of your DO probe to keep the sensor active with regular maintenance. For this purpose, Hanna has developed HI7041 electrolyte solution to refill the membrane cap.

<b>HI7041S</b>	refilling electrolyte solution (30 mL)
<b>HI7041M</b>	refilling electrolyte solution (250 mL)
<b>HI7041L</b>	refilling electrolyte solution (500 mL)



Multiparameter Guide.....7.2

- Product Spotlights..... 7.2
- Comparison Guides..... 7.2

Benchtop ..... 7.4

Portable..... 7.14

- Pool Line ..... 7.42
- GroLine® ..... 7.52

Replacement Probes ..... 7.58

HI98494

## Multiparameter Bluetooth® pH/EC/OPDO® Meter

pH, ORP, EC, TDS, Resistivity, Salinity, Seawater  $\sigma$ , Dissolved Oxygen, Atmospheric Pressure and Temperature

- **Bluetooth connectivity**
  - Retrieve data logs with Hanna Lab app for either sending by e-mail or download to a smart device for review
- **Waterproof**
  - IP67 rated waterproof, rugged enclosure for meter, IP68 for probe
- **Digital probe**
  - Digital probe with built-in temperature sensor and three ports for pH (ORP), EC and optical DO sensors
  - Color coded, field replaceable sensors
  - Auto-sensor recognition
  - Stainless steel, weighted protective guard

See page 7.28



## Multiparameter Guide

	(B) Benchtop, (P) Portable	pH	ORP	ISE	EC	TDS	Resistivity	Salinity	Temperature	Ammonium	Chloride	Nitrate	Seawater $\sigma$	Turbidity	Dissolved Oxygen	Atmospheric Pressure	Bluetooth®	GPS	Fast Tracker™	Logging	Page	
HI5522	B	•	•	•	•	•	•	•	•											•	7.4	
HI5521	B	•	•		•	•	•	•	•												•	7.10
HI9829	P	•	•		•	•	•	•	•	•	•	•	•	•	•	•		• <sup>1</sup>	•	•	•	7.14
HI98494	P	•	•		•	•	•	•	•				•	•	•	•	•				•	7.28
HI98194	P	•	•		•	•	•	•	•				•	•	•	•					•	7.34
HI98195	P	•	•		•	•	•	•	•				•								•	7.38
HI981954	P	•	•		•	•	•	•	•				•								•	7.42
HI98196	P	•	•						•						•	•					•	7.46
HI991300	P	•			•	•			•													7.50
HI991301	P	•			•	•			•													7.50
HI9814	P	•			•	•			•													7.52
HI9813-51	P	•			•	•			•													7.54
HI9813-61	P	•			•	•			•													7.54
HI9810-61	P	•			•	•			•													7.56
HI9811-51	P	•			•	•			•													7.56
HI9812-51	P	•			•	•			•													7.56

<sup>1</sup> Select Models





HI9829

## GPS Multiparameter Meters

*pH/ORP/ISE, EC/TDS/Resistivity/Salinity/Seawater  $\sigma$ , Turbidity, DO, Temperature and Atmospheric Pressure*

The HI9829 is a waterproof portable logging multiparameter meter that monitors up to 14 different water quality parameters.

The microprocessor based multi-sensor probe allows for the measurement of key parameters including pH, ORP, conductivity, dissolved oxygen, turbidity, ammonium, chloride, nitrate, and temperature. The probe transmits readings digitally with options to log data while disconnected from the meter. An optional GPS provides location tracking of measurements. The complete system is simple to setup and easy to use. The HI9829 is highly customizable and supplied with all necessary accessories, packaged in a durable carrying case.

See page 7.14



HI981954

## Multiparameter Waterproof Meter

*pH, ORP, EC, TDS, Resistivity, Salinity, Seawater  $\sigma$  and Temperature*

The HI981954 is a waterproof portable logging multiparameter meter that monitors up to 9 different water quality parameters. Its multi-sensor probe allows for the measurement of key parameters including pH, ORP, conductivity, and temperature. The probe transmits readings digitally to the meter, where data points can be displayed and logged. The complete system is simple to setup and easy to use.

See page 7.42



## Research Grade Meter

pH/ORP/ISE and EC/TDS/Resistivity/Salinity  
and Temperature



The HI5522 is an advanced research grade benchtop pH/ORP/ISE and EC/TDS/Salinity/Resistivity meter that is completely customizable with a large color LCD, capacitive touch keys, and USB port for computer connectivity.

The HI5522 is a two-channel meter that allows for simultaneous measure of pH, ORP, or ISE on one channel and EC, TDS, Salinity, or Resistivity on the other. Channel one has a BNC connection for use with the expansive line of pH, ORP, and ISE electrodes that Hanna Instruments offers. The meter is supplied with the HI1131B glass body, double junction, combination pH electrode that operates over a wide temperature range from 0 to 100°C. All readings are automatically compensated for temperature variations with the separate HI7662-T temperature probe or from the built in temperature sensor of the conductivity probe on Channel Two. The HI5522 is supplied with the

HI76312 four-ring conductivity probe that operates over a wide range from 0.000  $\mu\text{S}/\text{cm}$  to 1000.0  $\text{mS}/\text{cm}^*$ . The meter can be set to auto-ranging in which the meter chooses the appropriate conductivity range from seven ranges or fixed range in which the meter will only display reading in  $\mu\text{S}/\text{cm}$  or  $\text{mS}/\text{cm}$ . All readings are automatically compensated for temperature variations with a built in temperature sensor. The temperature correction coefficient is adjustable from 0.00 to 10.00  $\%/^{\circ}\text{C}$ .

As a pH meter the HI5522 can be calibrated up to five points with a choice of eight pre-programmed buffers or five custom buffers. The HI5522 features Hanna's exclusive CAL Check™ to alert the user of potential problems during the pH calibration process. Indicators displayed during calibration include "Electrode Dirty/Broken" and "Buffer Contaminated." The overall probe condition based on the offset

and slope characteristic of the electrode is displayed as a percentage after calibration is complete.

In ISE mode the HI5522 can be calibrated up to five points with a choice of five fixed standards or five user defined in any concentration unit. The calibration data including date, time, standards used and slope can be viewed at any time along with the current measurement by selecting the Good Laboratory Practice (GLP) display option.

As an EC/TDS/Salinity/Resistivity meter the HI5522 can be calibrated up to four points with a choice of six pre-programmed conductivity standards or user defined custom standards. Resistivity, TDS, Practical Salinity (PSU) and Natural Seawater Scale are calibrated through conductivity. The % NaCl is calibrated to single point with the HI7037 salinity standard. The calibration data including date, time, and

standards used, offset and cell factor can be accessed at any time along with the current measurement by selecting the Good Laboratory Practice (GLP) display option.

For the measurement of high purity water used in pharmaceutical manufacturing, the HI5522 is programmed with the three stages of the USP <645> method. Once a stage is met a report is generated and can be saved. Up to 200 reports can be stored and transferred to a Windows® compatible computer using the supplied USB cable and software.

Three selectable logging modes are available: automatic, manual and AutoHold logging. Up to 100,000 data points can be recorded in 100 lots with 50,000 records max/lot on each channel and exported to a computer for data review and storage.

## Customizable User Interface

The user interface of the HI5522 allows the user to show measurements in various modes: basic measurement with or without GLP information, real-time graphing, and logging data. Calibration stability criteria can be adjusted from fast, moderate, and accurate. Programmable alarm limits can be set to inside or outside allowable limits.

## Color Graphic LCD

The HI5522 features a color graphic LCD with on-screen help, graphic, and custom color configurations. The display allows for real-time graphing and the use of virtual keys provide for an intuitive user interface.

## Capacitive Touch

The HI5522 features sensitive capacitive touch buttons for accurate keystrokes when navigating menus and screens. There are four dedicated keys that are used for routine operations including calibration and switching measurement modes and four virtual keys that change based upon use. The capacitive touch technology ensures the buttons never get clogged with sample residue.

## Four Ring Conductivity Probe

All readings are performed with the HI76312 four-ring conductivity probe that has a built in temperature sensor for automatic temperature correction. The four rings are made with platinum and the body of the electrode is made of Polyetherimide (PEI) plastic that is resistant to many harsh chemicals. The four-ring design allows for this probe to be used over a wide range of measurements.

## Choice of Calibration

Automatic buffer recognition, semiautomatic, and direct manual entry pH calibration options are available for calibrating up to five points, from a selection of eight standard buffers and up to five custom buffers. For the conductivity channel the calibration can be set to automatic standard recognition or user entry along with a choice of single or multi-point. Calibration can be performed up to four points when multi-point is selected.

## CAL Check™

CAL Check alerts users to potential problems during the calibration of the pH electrode. Indicators include "Electrode Dirty/Broken," "Buffer Contaminated," electrode response time and the overall probe condition as a percentage that is based on the offset and slope characteristics.

## GLP Data

HI5522 includes a GLP Feature that allows users to view calibration data and calibration expiration information at the touch of a key. Calibration data include date, time, standards used for calibration.

## ISE Measurement with Choice of Concentration Units

The HI5522 allows for calibration and readings in choice of concentration units. The choices of concentration units include ppt, g/L, mg/mL, ppm, mg/L, µg/L, ppb, µg/L, mg/mL, M, mol/L, mmol/L, %w/v and a user-defined unit.

## ISE Measurement with Incremental Methods

The known addition, known subtraction, analyte addition, and analyte subtraction incremental methods are pre-programmed into the HI5522. Simply follow the on screen guided procedure and the meter will perform the calculation automatically allowing for a higher level of accuracy to be obtained as compared to a direct ISE measurement.

## Data Logging

Three selectable logging modes are available on the HI5522: automatic, manual, and AutoHold logging. Automatic and manual logs up to 100 lots with 50,000 records max/lot, with up to 100,000 total data points. Automatic logging features the option to save data according to sampling period and interval.

## Data Transfer

Data can be transferred to a PC with USB cable and HI92000 software (both sold separately).

## Contextual Help

Contextual help is always available through a dedicated "HELP" key. Clear tutorial messages and directions are available on-screen to quickly and easily guide users through setup and calibration. The help information displayed is relative to the setting/option being viewed.

## pH and EC Features

### pH CAL Check™

Proper calibration of the pH electrode system is critical in order to achieve reliable results. Hanna's exclusive CAL Check system includes several features to help users reach that goal.

- Each time a pH calibration is performed, the instrument compares the new calibration with the previous one. When this comparison indicates a significant difference, the message alerts the user to either clean the electrode, check the buffer or both.
- When measurements are taken too far from the calibration points, the instrument will warn the user with a message on the LCD.
- The condition of the pH electrode after calibration is shown on the display, as well as the date and time.
- To avoid taking readings with old calibrations, the instrument automatically reminds the user when the calibration has expired.

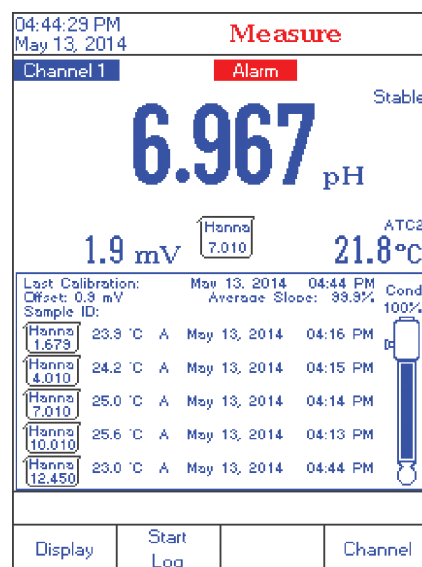
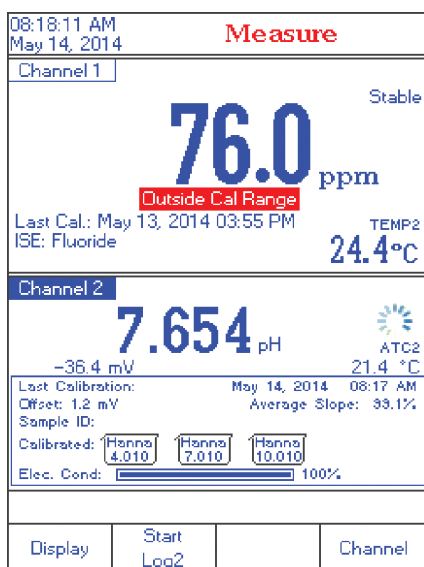
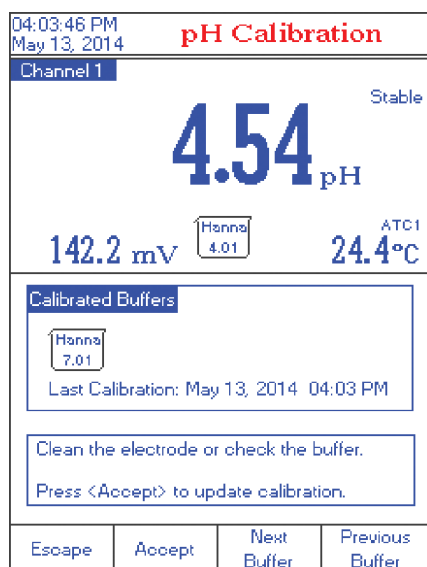

### EC USP Mode

Hanna's HI5522 and HI5521 together with EC probes can be used for conductivity measurements required to prepare water for injection (WFI) according to USP <645>.

The instruments give clear instructions on how to perform each stage and automatically check that the temperature, conductivity and stability are within USP limits.

Comprehensive results are shown on a single screen at the end of the test. Up to 200 reports can be saved for future recall.

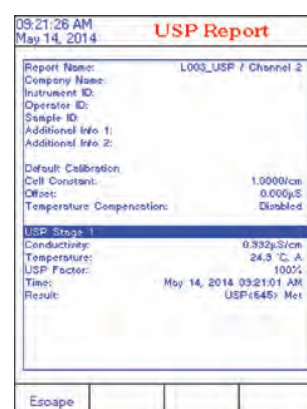
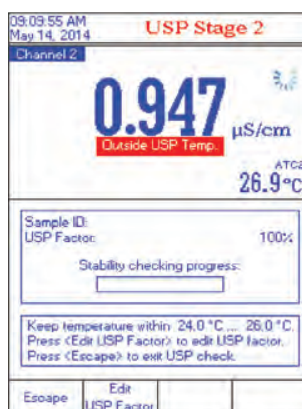
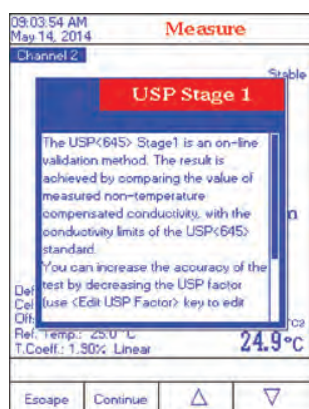

## ISE Features

### ISE Incremental Methods

Ion concentration determinations with ISEs can be made faster and easier using the streamlined incremental methods.

Incremental methods involve adding a standard to a sample or sample to a standard and detecting the mV change that occurs due to the addition, and this difference determines the concentration. Historically the user would use mathematical equations to determine the ion concentration of the sample; the HI5522, sample concentrations are calculated automatically and then logged into an ISE method report; up to 200 reports can be saved for future recall. The entire process can be repeated on multiple samples without reentering sets of parameters. Reports can be printed using HI92000 PC software.

Incremental method techniques can reduce errors from variables such as temperature, viscosity, pH or ionic strength. The electrodes remain immersed throughout the process, thus reducing measurement time as well as eliminating sample carry over and its associated errors.

Known Addition, Known Subtraction, Analyte Addition, and Analyte Subtraction methods are standard method choices provided by the HI5522.

08:05:39 AM May 14, 2014		Known Subtraction	
Channel 1		Stable	
14.8 mV		TEMP1 22.4 °C	
First Step First Reading			
Manual Edit			
Sample Vol.	100.000	mL	
ISA Vol.	2.000	mL	
Std. Vol.	10.000	mL	
Std. Conc.	100	ppm	
Stoich. Factor	1.0		
then press <Continue>.			
Escape	Edit	Next	Previous

#### First Step

The first step in performing an incremental method analysis is to enter the required parameters including sample, ISA and standard volumes, as well as standard concentration and stoichiometric factor.

When repeating the analysis on another sample, the parameters do not need to be reentered.

08:09:43 AM May 14, 2014		Known Addition	
Channel 1		Stable	
10.5 mV		TEMP1 21.7 °C	
First Step First Reading			
Second Step Second Reading			
Sample Volume:	100.000	mL	
ISA Buffer Vol. :	2.000	mL	
Reagent Volume:	2.000	mL	
Reagent Conc.:	1000	ppm	
Press <Read> to memorize the current reading and to pass to the next method step.			
Escape	Read		

#### Sequence of Readings

Once the variables are entered, the user is guided step-by-step through the measurement process.

The initial mV measurement is made before the addition; next is the addition, followed by the second mV measurement.

08:11:14 AM May 14, 2014		ISE Results	
Channel 1		Stable	
35.9 ppm		TEMP1 21.7 °C	
Sample ID:		Calculated Slope:	100.1 %
Reading 1:	10.5 mV	Reading 2:	-0.4 mV
Sample Volume:	100.000 mL	Reagent Volume:	2.000 mL
ISA Volume:	2.000 mL	Reagent Conc.:	1000 ppm
Press <Direct Measure> to return in main measurement panel. Press <Save> to log the current results.			
Direct Measure	Save	Edit	Start KA

#### Results

The results are automatically calculated and shown together with all the parameters used.

At this time, results can be saved into an ISE Methods Report and printed using the HI92000 PC software.



- **Low Profile**
  - HI5522 features a low profile with an ideal viewing angle

## Additional Features by Screen

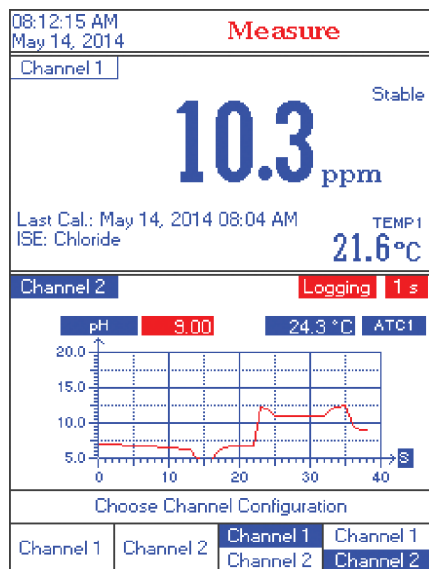

Channel Configuration

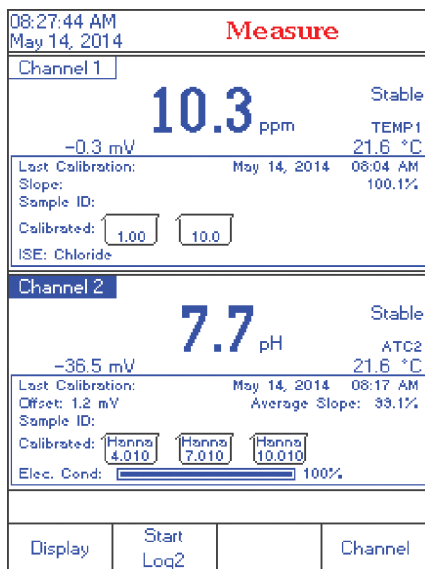

Good Laboratory Practices

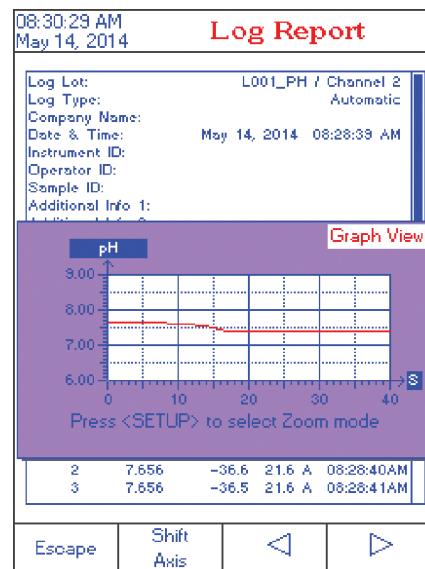

Log Recall

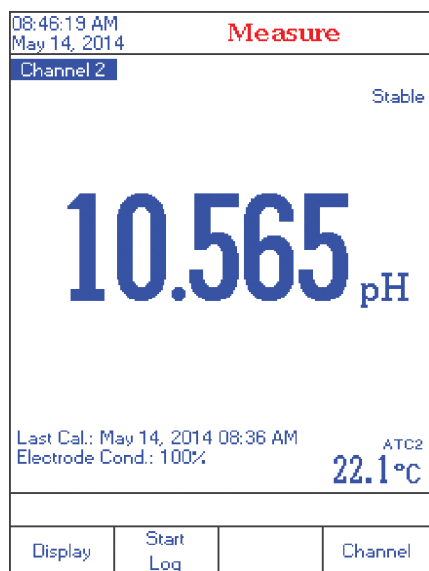

Basic Display

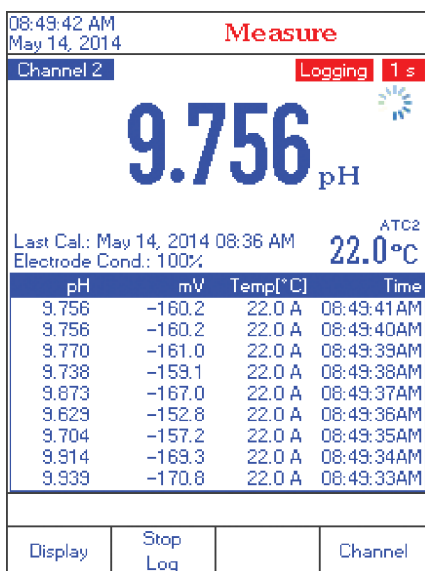

Real-Time Logging

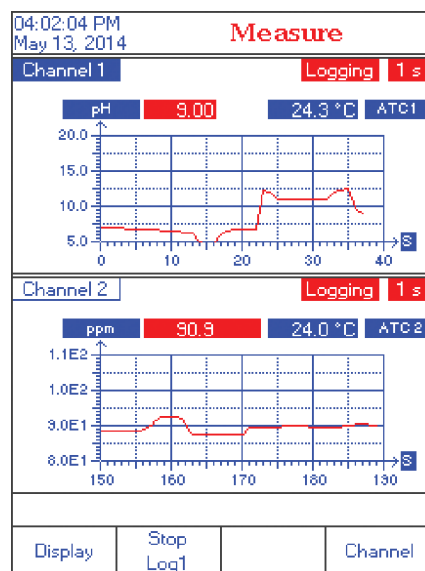

Simultaneous Dual-Channel Graphing



## Dual Channels

The two measurement channels of the HI5522 are galvanically isolated to eliminate noise and instability.

In ISE mode, this instrument provides a choice of several incremental methods. Communication is via opto-isolated USB.

Specifications	HI5522	
pH	Range	-2.0 to 20.0 pH; -2.00 to 20.00; -2.000 to 20.000 pH
	Resolution	0.1 pH; 0.01 pH; 0.001 pH
	Accuracy	±0.1 pH; ±0.01 pH; ±0.002 pH ±1 LSD
	Calibration	automatic, up to five-point calibration, eight standard buffers available (1.68, 3.00, 4.01, 6.86, 7.01, 9.18, 10.01, 12.45), and five custom buffers
	Temperature Compensation	automatic or manual from -20.0 to 120.0°C/-4.0 to 248.0°F/253.15 to 393.15K
mV	Range	±2000 mV
	Resolution	0.1 mV
	Accuracy	±0.2 mV ±1 LSD
ISE	Range	1 x 10 <sup>-6</sup> to 9.99 x 10 <sup>10</sup> concentration
	Resolution	1; 0.1; 0.01; 0.001 concentration
	Accuracy	±0.5% (monovalent ions); ±1% (divalent ions)
	Calibration	automatic, up to five-point calibration, seven fixed standard solutions available for each measurement unit, and five user defined standards
Temperature**	Range	-20.0 to 120°C; -4.0 to 248.0°F; 253.15 to 393.15K
	Resolution	0.1°C; 0.1°F; 0.1K
	Accuracy	±0.2°C; ±0.4°F; ±0.2K (without probe)
EC	Range	0.000 to 9.999 µS/cm; 10.00 to 99.99 µS/cm; 100.0 to 999.9 µS/cm; 1.000 to 9.999 mS/cm; 10.00 to 99.99 mS/cm; 100.0 to 1000.0 mS/cm absolute EC*
	Resolution	0.001 µS/cm; 0.01 µS/cm; 0.1 µS/cm; 0.001 mS/cm; 0.01 mS/cm; 0.1 mS/cm
	Accuracy	±1% of reading (±0.01 µS/cm)
	Cell Constant	0.0500 to 200.00
	Cell Type	4-pole cell
	Calibration	automatic standard recognition, user standard single point / multi-point calibration
	Calibration Reminder	yes
	Temperature Coefficient	0.00 to 10.00 %/°C
	Temperature Compensation	disabled, linear and non-linear (natural water)
	Reference Temperature	5.0 to 30.0°C
	Profiles	up to 10, 5 each channel
	USP Compliant	yes
TDS	Range	0.000 to 9.999 ppm; 10.00 to 99.99 ppm; 100.0 to 999.9 ppm; 1.000 to 9.999 ppt; 10.00 to 99.99 ppt; 100.0 to 400.0 ppt actual TDS* (with 1.00 factor)
	Resolution	0.001 ppm; 0.01 ppm; 0.1 ppm; 0.001 ppt; 0.01 ppt; 0.1 ppt
	Accuracy	±1% of reading (±0.01 ppm)
Resistivity	Range	1.0 to 99.9 Ω•cm; 100 to 999 Ω•cm; 1.00 to 9.99 kΩ•cm; 10.0 to 99.9 kΩ•cm; 100 to 999 kΩ•cm; 1.00 to 9.99 MΩ•cm; 10.0 to 100.0 MΩ•cm
	Resolution	0.1 Ω•cm; 1 Ω•cm; 0.01 kΩ•cm; 0.1 kΩ•cm; 1 kΩ•cm; 0.01 MΩ•cm; 0.1 MΩ•cm
	Accuracy	±2% of reading (±1 Ω•cm)
Salinity	Range	practical scale: 0.00 to 42.00 psu; natural sea water scale: 0.00 to 80.00 ppt; percent scale: 0.0 to 400.0%
	Resolution	0.01 for practical scale/natural sea water scale; 0.1% for percent scale
	Accuracy	±1% of reading
	Calibration	percent scale – one-point (with HI7037 standard); all others through EC
Additional Specifications	pH Electrode	HI1131B glass body pH electrode with BNC connector and 1 m (3.3') cable (included)
	EC Probe	HI76312 platinum, four-ring EC/TDS probe with and 1 m (3.3') cable (included)
	Temperature Probe	HI7662-W stainless steel temperature probe with 1 m (3.3') cable (included)
	Input Channel(s)	1 pH/ORP/ISE + 1 EC
	GLP	cell constant, reference temperature/coefficient, calibration points, cal time stamp, probe offset for conductivity
	Logging	<b>record:</b> Up to 100 lots, 50,000 records max/lot / maximum 100,000 data points/channel; <b>interval:</b> 14 selectable between 1 second and 180 minutes; <b>type:</b> automatic, manual, AutoHOLD; <b>additional:</b> 200 records USP; 200 records incremental methods
	PC Connection	USB
	Power Supply	12 VDC adapter (included)
	Environment	0 to 50°C (32 to 122°F; 273 to 323K) RH max 95% non-condensing
Dimensions / Weight	160 x 231 x 94 mm (6.3 x 9.1 x 3.7") / 1.2 kg (2.64 lbs.)	
Ordering Information	<b>HI5522-01</b> (115V) and <b>HI5522-02</b> (230V) are supplied with HI1131B pH electrode, HI76312 EC/TDS probe, HI7662-W temperature probe, pH 4.01 buffer solution sachet (2), pH 7.01 buffer solution sachet (2), pH 10.01 buffer solution sachet (2), 1413 µS/cm conductivity standard sachet (2), 12880 µS/cm conductivity standard sachet (2), HI700601 electrode cleaning solution sachet (2), HI7082 3.5M KCl electrolyte solution (30 mL), HI76404W electrode holder, 12 VDC adapter, capillary dropper pipette, quality certificate, quick start guide and instruction manual.	

(\*) Uncompensated conductivity (or TDS) is the conductivity (or TDS) value without temperature compensation.

(\*\*) Reduced to actual probe limits

pH and ORP electrodes begin on page 2.154; pH and ORP solutions begin on page 2.174;  
ISE electrodes and solutions begin on page 3.22; EC, TDS and salinity solutions begin on page 5.36

## Research Grade Meter

pH/ORP and EC/TDS/Resistivity/Salinity  
and Temperature



The HI5521 is an advanced, two channel research grade benchtop pH/ORP and EC/TDS/Salinity/Resistivity meter that is completely customizable with a large color LCD, capacitive touch keys, and USB port for computer connectivity.

The HI5521 allows for simultaneous measure of pH or ORP on one channel and EC or related parameters on the other. Channel one has a BNC connection for use with the expansive line of pH and ORP electrodes that Hanna Instruments offers. The meter is supplied with the HI1131B glass body, double junction, combination pH electrode that operates over a wide temperature range from 0 to 100°C. All readings are automatically compensated for temperature variations with the separate HI7662-T temperature probe or from the built in temperature sensor of the conductivity probe on Channel two. The

HI5521 is supplied with the HI76312 four-ring conductivity probe that operates over a wide range from 0.000  $\mu\text{S}/\text{cm}$  to 1000.0  $\text{mS}/\text{cm}^*$ . The meter can be set to auto-ranging in which the meter chooses the appropriate conductivity range from seven ranges or fixed range in which the meter will only display reading in  $\mu\text{S}/\text{cm}$  or  $\text{mS}/\text{cm}$ . All readings are automatically compensated for temperature variations with a built in temperature sensor. The temperature correction coefficient is adjustable from 0.00 to 10.00  $\%/^{\circ}\text{C}$ .

As a pH meter the HI5521 can be calibrated up to five points with a choice of eight pre-programmed buffers or five custom buffers. The HI5521 features Hanna's exclusive CAL Check™ to alert the user of potential problems during the pH calibration process. Indicators displayed during calibration include "Electrode Dirty/Broken" and



“Buffer Contaminated.” The overall probe condition based on the offset and slope characteristic of the electrode is displayed as a percentage after calibration is complete. The calibration data including date, time, buffers used, offset and slope can be accessed at any time along with the current measurement by selecting the Good Laboratory Practice (GLP) display option.

As an EC/TDS/Salinity/Resistivity meter the HI5521 can be calibrated up to four points with a choice of six pre-programmed conductivity standards or user defined custom standards. Resistivity, TDS, Practical Salinity (PSU) and Natural Seawater Scale are calibrated through conductivity. The % NaCl is calibrated to single point with the HI7037 salinity standard. The calibration data including date, time, and

standards used, offset and cell factor can be accessed at any time along with the current measurement by selecting the Good Laboratory Practice (GLP) display option.

For the measurement of high purity water used in pharmaceutical manufacturing, the HI5521 is programmed with the three stages of the USP <645> method. Once a stage is met a report is generated and can be saved. Up to 200 reports can be stored and with the USB port be transferred to a Windows® compatible computer.

Three selectable logging modes are available: automatic, manual and AutoHold logging. Up to 100,000 data points can be recorded in 100 lots with 50,000 records max/lot on each channel and exported to a computer for data review and storage.

## Customizable User Interface

The user interface of the HI5521 allows the user to show measurements in various modes: basic measurement with or without GLP information, real-time graphing, and logging data. Calibration stability criteria can be adjusted from fast, moderate, and accurate. Programmable alarm limits can be set to inside or outside allowable limits.

## Color Graphic LCD

The HI5521 features a color graphic LCD with on-screen help, graphic, and custom color configurations. The display allows for real-time graphing and the use of virtual keys provide for an intuitive user interface.

## Capacitive Touch

The HI5521 features sensitive capacitive touch buttons for accurate keystrokes when navigating menus and screens. There are four dedicated keys that are used for routine operations including calibration and switching measurement modes and four virtual keys that change based upon use. The capacitive touch technology ensures the buttons never get clogged with sample residue.

## Four Ring Conductivity Probe

All readings are performed with the HI76312 four-ring conductivity probe that has a built in temperature sensor for automatic temperature correction. The four rings are made with platinum and the body of the electrode is made of Polyetherimide (PEI) plastic that is resistant to many harsh chemicals. The four-ring design allows for this probe to be used over a wide range of measurements.

## Choice of Calibration

Automatic buffer recognition, semiautomatic, and direct manual entry pH calibration options are available for calibrating up to five points, from a selection of eight standard buffers and up to five custom buffers. For the conductivity channel the calibration can be set to automatic standard recognition or user entry along with a choice of single or multi-point. Calibration can be performed up to four points when multi-point is selected.

## CAL Check™

CAL Check alerts users to potential problems during the calibration of the pH electrode. Indicators include “Electrode Dirty/Broken,” “Buffer Contaminated,” electrode response time and the overall probe condition as a percentage that is based on the offset and slope characteristics.

## GLP Data

HI5521 includes a GLP Feature that allows users to view calibration data and calibration expiration information at the touch of a key. Calibration data include date, time, standards used for calibration.

## Data Logging

Three selectable logging modes are available on the HI5521: automatic, manual, and AutoHold logging. Automatic and manual logs up to 100 lots with 50,000 records max/lot, with up to 100,000 total data points. Automatic logging features the option to save data according to sampling period and interval.

## Data Transfer

Data can be transferred to a PC with USB cable and HI92000 software (both sold separately).

## Contextual Help

Contextual help is always available through a dedicated “HELP” key. Clear tutorial messages and directions are available on-screen to quickly and easily guide users through setup and calibration. The help information displayed is relative to the setting/option being viewed.



## Dual Channels

The two measurement channels of the HI5521 are galvanically isolated to eliminate noise and instability.

Communication is via opto-isolated USB.

## pH and EC Features

### pH CAL Check™

Proper calibration of the pH electrode system is critical in order to achieve reliable results. Hanna's exclusive CAL Check system includes several features to help users reach that goal.

- Each time a pH calibration is performed, the instrument compares the new calibration with the previous one. When this comparison indicates a significant difference, the message alerts the user to either clean the electrode, check the buffer or both.
- When measurements are taken too far from the calibration points, the instrument will warn the user with a message on the LCD.
- The condition of the pH electrode after calibration is shown on the display, as well as the date and time.
- To avoid taking readings with old calibrations, the instrument automatically reminds the user when the calibration has expired.

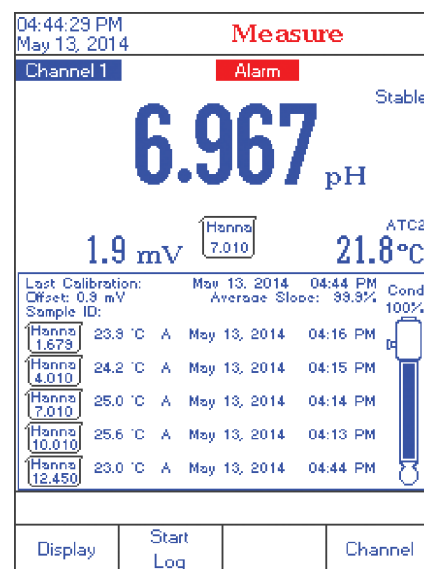
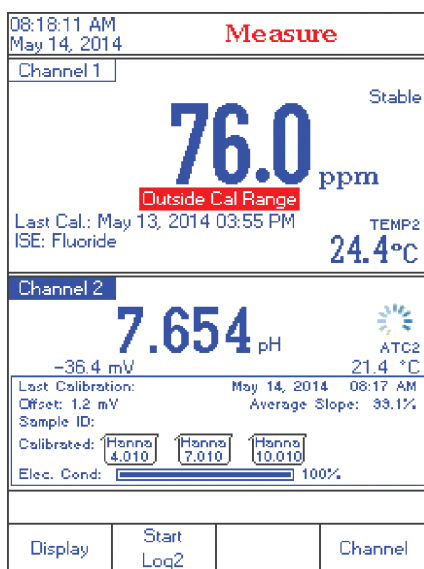
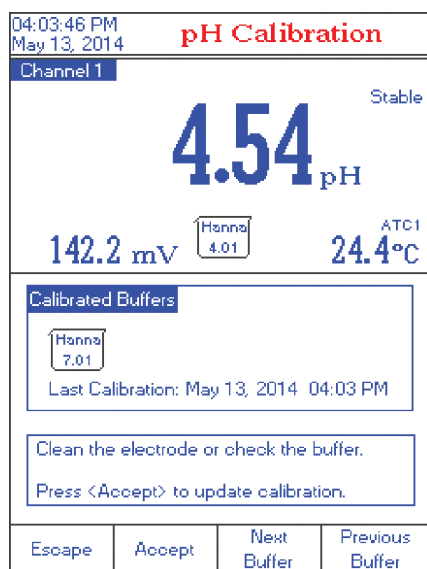

### EC USP Mode

Hanna's HI5522 and HI5521 together with EC probes can be used for conductivity measurements required to prepare water for injection (WFI) according to USP <645>.

The instruments give clear instructions on how to perform each stage and automatically check that the temperature, conductivity and stability are within USP limits.

Comprehensive results are shown on a single screen at the end of the test. Up to 200 reports can be saved for future recall.

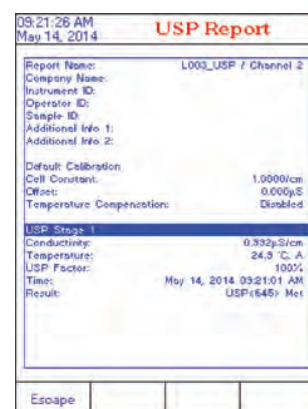
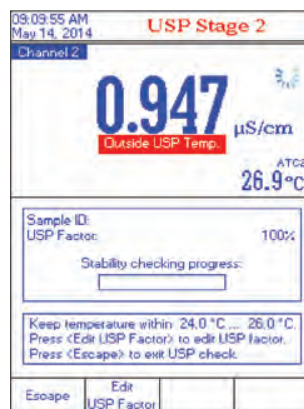

## Specifications

## HI5521

pH	Range	-2.0 to 20.0 pH; -2.00 to 20.00; -2.000 to 20.000 pH
	Resolution	0.1 pH; 0.01 pH; 0.001 pH
	Accuracy	±0.1 pH; ±0.01 pH; ±0.002 pH ±1 LSD
	Calibration	automatic, up to five-point calibration, eight standard buffers available (1.68, 3.00, 4.01, 6.86, 7.01, 9.18, 10.01, 12.45), and five custom buffers
	Temperature Compensation	automatic or manual from -20.0 to 120.0°C/-4.0 to 248.0°F/253.15 to 393.15K
mV	Range	±2000 mV
	Resolution	0.1 mV
	Accuracy	±0.2 mV ±1 LSD
Temperature**	Range	-20.0 to 120°C; -4.0 to 248.0°F; 253.15 to 393.15K
	Resolution	0.1°C; 0.1°F; 0.1K
	Accuracy	±0.2°C; ±0.4°F; ±0.2K (without probe)
EC	Range	0.000 to 9.999 µS/cm; 10.00 to 99.99 µS/cm; 100.0 to 999.9 µS/cm; 1.000 to 9.999 mS/cm; 10.00 to 99.99 mS/cm; 100.0 to 1000.0 mS/cm absolute EC*
	Resolution	0.001 µS/cm; 0.01 µS/cm; 0.1 µS/cm; 0.001 mS/cm; 0.01 mS/cm; 0.1 mS/cm
	Accuracy	±1% of reading (±0.01 µS/cm)
	Cell Constant	0.0500 to 200.00
	Cell Type	4-pole cell
	Calibration	automatic standard recognition, user standard single point / multi-point calibration
	Calibration Reminder	yes
	Temperature Coefficient	0.00 to 10.00 %/°C
	Temperature Compensation	disabled, linear and non-linear (natural water)
	Reference Temperature	5.0 to 30.0°C
	Profiles	up to 10, 5 each channel
	USP Compliant	yes
TDS	Range	0.000 to 9.999 ppm; 10.00 to 99.99 ppm; 100.0 to 999.9 ppm; 1.000 to 9.999 ppt; 10.00 to 99.99 ppt; 100.0 to 400.0 ppt actual TDS* (with 1.00 factor)
	Resolution	0.001 ppm; 0.01 ppm; 0.1 ppm; 0.001 ppt; 0.01 ppt; 0.1 ppt
	Accuracy	±1% of reading (±0.01 ppm)
Resistivity	Range	1.0 to 99.9 Ω•cm; 100 to 999 Ω•cm; 1.00 to 9.99 kΩ•cm; 10.0 to 99.9 kΩ•cm; 100 to 999 kΩ•cm; 1.00 to 9.99 MΩ•cm; 10.0 to 100.0 MΩ•cm
	Resolution	0.1 Ω•cm; 1 Ω•cm; 0.01 kΩ•cm; 0.1 kΩ•cm; 1 kΩ•cm; 0.01 MΩ•cm; 0.1 MΩ•cm
	Accuracy	±2% of reading (±1 Ω•cm)
Salinity	Range	practical scale: 0.00 to 42.00 psu; natural sea water scale: 0.00 to 80.00 ppt; percent scale: 0.0 to 400.0%
	Resolution	0.01 for practical scale/natural sea water scale; 0.1% for percent scale
	Accuracy	±1% of reading
	Calibration	percent scale—one-point (with HI7037 standard); all others through EC
Additional Specifications	pH Electrode	HI1131B glass body pH electrode with BNC connector and 1 m (3.3') cable (included)
	EC Probe	HI76312 platinum, four-ring EC/TDS probe with and 1 m (3.3') cable (included)
	Temperature Probe	HI7662-W stainless steel temperature probe with 1 m (3.3') cable (included)
	Input Channel(s)	1 pH/ORP + 1 EC
	GLP	cell constant, reference temperature/coefficient, calibration points, cal time stamp, probe offset for conductivity
	Logging	<b>record</b> : Up to 100 lots, 50,000 records max/lot / maximum 100,000 data points/channel; <b>interval</b> : 14 selectable between 1 second and 180 minutes; <b>type</b> : automatic, manual, AutoHOLD;
	PC Connection	USB
	Power Supply	12 VDC adapter (included)
	Environment	0 to 50°C (32 to 122°F; 273 to 323K) RH max 95% non-condensing
	Dimensions / Weight	160 x 231 x 94 mm (6.3 x 9.1 x 3.7") / 1.2 kg (2.64 lbs.)
Ordering Information	<b>HI5521-01</b> (115V) and <b>HI5521-02</b> (230V) are supplied with HI1131B pH electrode, HI76312 EC/TDS probe, HI7662-W temperature probe, pH 4.01 buffer solution sachet (2), pH 7.01 buffer solution sachet (4), pH 10.01 buffer solution sachet (2), HI700601 electrode cleaning solution sachet (2), HI7082 3.5M KCl electrolyte solution (30 mL), HI76404W electrode holder, 12 VDC adapter, capillary dropper pipette, quality certificate, quick start guide and instruction manual.	

(\*) Absolute conductivity (or TDS) is the conductivity (or TDS) value without temperature compensation.

(\*\*) Reduced to actual probe limits

HI9829

## GPS Multiparameter Meters

*pH/ORP/ISE, EC/TDS/Resistivity/  
Salinity/Seawater  $\sigma$ , Turbidity, DO,  
Temperature and Atmospheric  
Pressure*

- **Logging**
  - Logging from probe or meter
- **Fast Tracker**
  - Tag Identification System
- **Sensor Check™**
  - Auto-recognition of all sensors
- **GLP features**
  - Meets Good Laboratory Practices
- **Connectivity**
  - PC compatible via USB
- **Help feature**
  - On-screen user guides
- **Backlight**
  - Backlit, graphic LCD display
- **Waterproof**
  - Waterproof casing



## Waterproof Protection

The meter is enclosed in an IP67 rated waterproof casing and can withstand immersion in water at a depth of 1 m for up to 30 minutes. The probe features an IP68 rating for continuous immersion in water.

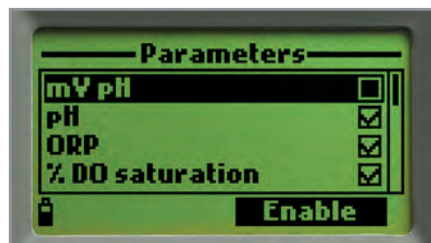

## Backlit Dot Matrix LCD Display

The HI9829 features a backlit graphic LCD with on-screen help and the capability to display up to twelve parameters simultaneously. The graphic display allows for the use of virtual keys to provide for an intuitive user interface.

## Intuitive Keypad

The fitted rubber keypad has dedicated keys for power, backlight, up/down arrows, help and alphanumeric characters. The meter also features two virtual soft keys that navigate the user through the configuration of each parameter, meter setup, and logging of data. The interface is intuitive for any user's level of experience.



## Auto-sensor Recognition

The probe and meter automatically recognize the sensors that are connected. Any ports not used on the probe will not have the parameter displayed or be configurable.

## Automatic Temperature Compensation

Integrated temperature sensor allows for automatic temperature compensation of pH, conductivity, and dissolved oxygen measurements.

## Automatic Barometric Pressure Compensation

The meter features a built-in barometer with user-selectable units for dissolved oxygen pressure compensation.



## Quick Calibration

Quick Calibration provides a speedy, single point calibration for pH, conductivity, and dissolved oxygen. Standard calibration options are available including pH up to three points, conductivity at one point and dissolved oxygen up to two points.

## Dedicated Help Key

Contextual help is always available through a dedicated "HELP" key. Clear tutorial messages and directions are available on-screen to quickly and easily guide users through setup and calibration. The help information displayed is relative to the setting/option being viewed.

## GLP Data

HI9829 includes a GLP feature that allows users to view calibration data and calibration expiration information at the touch of a key. Calibration data includes date, time, buffers/standards used for calibration, and slope characteristics.

## Data Logging

The HI9829 allows users to store up to 44,000 continuous or log-on-demand samples with logging intervals from one second to three hours.

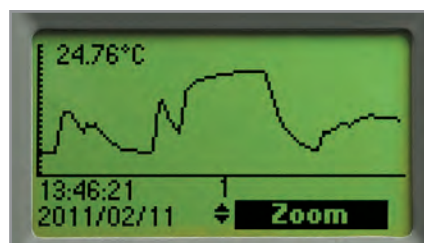

## Graphing Capability

Trend graphing with sample date and time stamp may be viewed on the display or transferred to a PC.

## PC Connectivity

Logged data can be transferred to a Windows compatible PC with the included HI7698291 USB adapter and HI929829 software.

## Long Battery Life

The display of the meter has a battery icon indicator to show the remaining power. The meter is supplied with four 1.5V "C" NiMH rechargeable batteries that provide up to 140 hours of battery life\*

\* Without GPS or turbidity measurements



## Rugged Custom Carrying Case

The HI9829 meter, probe, and all accessories are supplied in a rugged carrying case designed to provide years of use. The inside compartment of the carrying case is thermoformed to securely hold and protect all of the components.



### HI7698297 Quick Release Flow Cell (optional)

The HI7698297 is an optional quick release flow cell designed for low flow sampling of environmental groundwater. The flow cell features a threaded collar for the HI9829 probe and two quick release fittings for inlet and outlet flow. The HI7698297 includes a wall mount kit for continuous monitoring option.

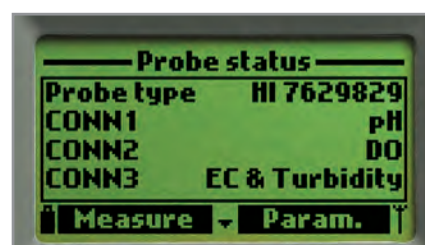
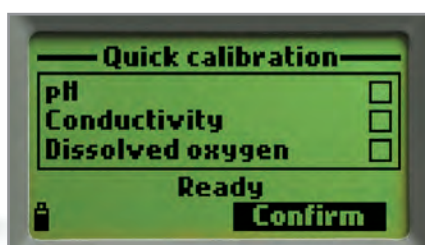

- **Field Ready**

- For field calibration, our quick calibration solution allows standardization of pH and conductivity with one calibration solution.

- **Quick Calibration**

- Simply screw the calibration beaker filled with HI9828-25 solution onto the probe, select "Quick calibration" from the menu and press OK. Individual calibration may also be performed using multiple calibration points.

- **Auto-sensor Recognition**

- In this example, the HI9829 is identifying a pH, dissolved oxygen and EC/turbidity sensor.

## Probes

The use of Hanna's microprocessor-based multiparameter intelligent probes with HI9829 will provide reliable data collection that can lead to an improved scientific understanding of the interconnections between natural, chemical and geological processes and manmade pollution to effectively evaluate applications for waste discharge permits, remediate contaminated sites and to protect or restore biological resources.

Reliable temperature measurements are a critical parameter of aquatic system monitoring. Temperature and temperature changes due to water releases can affect the ability of water to hold oxygen as well as the ability of organisms to resist certain pollutants. The intelligent probes incorporate an accurate thermistor that changes predictably with temperature changes. Accurate temperature reading in degrees Celsius, Fahrenheit and kelvin are displayed and utilized by other detectors for temperature correction.

The HI76x9829 probes utilize field replaceable sensors with auto-recognition. The sensors are housed with the probe electronics in a rugged housing and a water-tight cable connection. The HI76909829 probe allows conductivity, pH/ORP (or an ISE), and dissolved oxygen measurement. Other probe models allow turbidity and logging.

Probes with the logging function have a logging memory that allows storage of up to 140,000 individual samples or 35,000 complete

sample data sets with date and time stamp thus permitting up to a 70 day deployment with all channels logging at 10 minute intervals. The probe incorporates a temperature sensor for temperature compensation of all parameters.

The probes are available with a choice of cable lengths such as 4m, 10 m and 20 m (13', 33', 65') that utilize a DIN connection to interface with the meters. Logging probes can be connected directly to a PC with the HI76982910 USB adapter cable, and HI929829 PC application software to download log files directly from the probes.

## Sensors

Hanna offers a selection of seven sensors to be used on the intelligent probes. Sensor replacement is quick and easy with screw type connectors and are color coded for easy identification. The HI9829 automatically recognizes sensor presence.

The HI7609829-4 EC/turbidity sensor is field replaceable and offers readings from both parameters at the same time.

All potentiometric sensors feature a double junction design and are gel filled to increase resistance to contamination. One of the ISE sensors can be used in place of the pH sensor and is automatically recognized. pH in mV readings are also displayed –which is useful for troubleshooting.



HI7609829  
for pH/ORP, Dissolved  
Oxygen, EC

HI7629829  
for pH/ORP, Dissolved  
Oxygen, EC, Logging

With two probes to choose from, these digital probes provide stable, noise-free sensor signal management without the need for pre-amplified pH sensors.

Specifications	HI7609829	HI7629829	
Supported Configuration	Connector 1	pH, pH/ORP, ammonium ISE, chloride ISE, nitrate ISE	
	Connector 2	dissolved oxygen	
	Connector 3	EC	
Temperature sensor	built-in	built-in	
Autonomous Logging	-	yes	
Logging Interval	-	1 second to 3 hours	
Computer Interface	-	USB (HI76982910)	
Memory	-	140,000 measurements (single parameter logged); 35,000 measurements (all parameters logged)	
Operating Temperature	-5 to 55°C*	-5 to 55°C*	
Maximum Depth	20 m (66')*	20 m (66')*	
Cable Specification	multistrand-multiconductor shielded cable with internal strength member rated for 68 kg (150 lb.) intermittent use		
Wetted Materials	body: ABS; threads: nylon; shield: ABS/316 SS; temperature probe: 316 SS; O-rings: EPDM		
Logging Probe Internal Battery Type	-	1.5V (4) AA alkaline	
Logging Probe Battery Life <small>Note: Log space must be available for continuous logging</small>	-	Interval	all channels logging (no averaging)
		1-5 seconds	72 hours
		1 minute	22 days
		10 minutes	70 days
Sample Environment	fresh, brackish, seawater	fresh, brackish, seawater	
Waterproof Protection	IP68	IP68	
Dimensions (without cable)	342 mm (13.5"), dia=46 mm (1.8")	442 mm (17.4"), dia 46 mm (1.8")	
Weight (with batteries and sensors)	570 g (20.1 oz.)	775 g (27.3 oz.)	

\* Reduced for ISE sensors

## Sensor Configurations

Both probes can accommodate a multitude of sensor configurations. The long sensor cap fits all configurations while the short sensor cap fits configurations not requiring the turbidity/EC sensor.



### Dissolved Oxygen

**HI7609829-2** DO

The dissolved oxygen in lakes, rivers, and oceans is crucial for the organisms and creatures living in it. If dissolved oxygen concentrations drop below normal levels in water bodies, the water quality degrades and the organisms begin to die off. The HI7609829-2 galvanic DO sensor does not require long polarization times so is ready for measurement at a moment's notice. This sensor also utilizes a replaceable cap design for ease of maintenance and a safe, non-toxic electrolyte. DO readings are compensated for the effects of temperature (using the probe's built-in temperature sensor) and atmospheric pressure (using the HI 9829's internal atmospheric pressure sensor). The DO measurement complies with standard methods 4500-O G and EPA article 360.1.



### pH

**HI7609829-0** pH  
**HI7609829-1** pH/ORP

The HI7609829-0 and -1 feature a double junction design and are gel filled to increase resistance to contamination. These pH or pH/ORP sensors incorporate the technology that has made Hanna so successful as a pH manufacturer. Reliable pH measurements are one of the most important indicators of water chemistry indicating the relative amount of free hydrogen and hydroxyl ions in the water. Hanna's pH sensors utilize a resilient PEI body to protect them from solid particulates found in water samples. Consistency and quality are the hallmarks of these sensors. Our differential measurement system further enhances the measurement reliability, providing temperature corrected pH.

OR



### ISE

**HI7609829-10** Ammonium ISE  
**HI7609829-11** Chloride ISE  
**HI7609829-12** Nitrate ISE

A choice of three ion selective electrodes (ISE) is available for constant reporting of common surface water contaminants. Nitrate, ammonium and chloride ISEs are available. Each ISE is a combination electrode incorporating an extremely constant reference spiral; all potentiometric probes feature a double junction and solid gel reference design. The HI9829 displays measurements of ion activity as ppm ammonium-nitrogen, ppm chloride, and ppm nitrate-nitrogen.

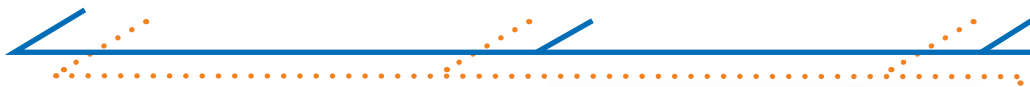

**HI7698295**

Short cap for probes without EC/turbidity sensor



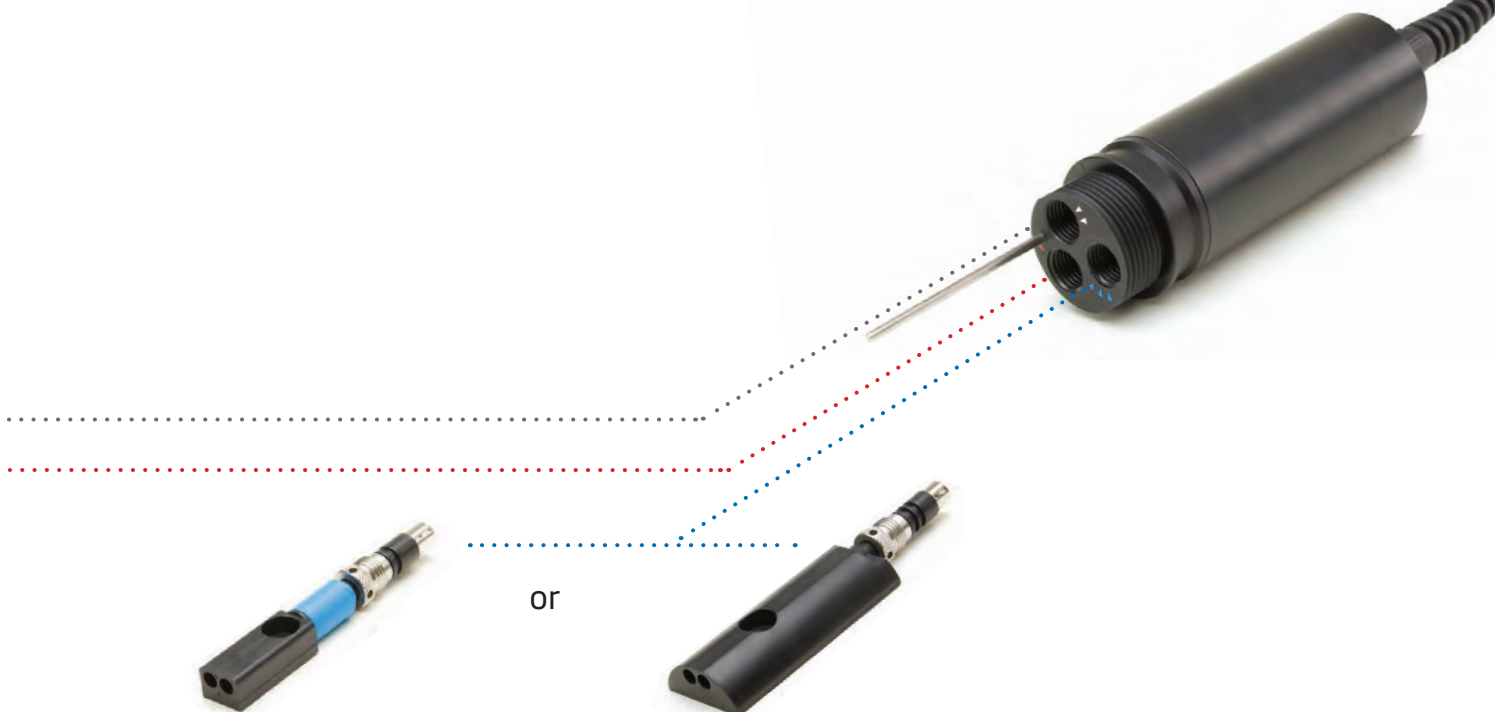

or

## Conductivity

HI7609829-3 EC

The HI7609829-3 4-electrode conductivity sensor using the polarographic measurement principle ensures stable conductivity readings. Electrolytic conductivity measures the ability of water to conduct an electrical current. It is highly dependent on the amount of dissolved solids (such as salt) in the water. Absolute conductivity, temperature-corrected conductivity, salinity. Seawater and water hardness (TDS) determinations are possible with measurements from this sensor.

## Conductivity and Turbidity

HI7609829-4 EC/Turbidity

The HI7609829-4 combined EC/turbidity sensor is a replaceable design for instantaneous conductivity and turbidity measurements that conform to ISO 7027 standards. It provides measurements from 0.0 to 1000 FNU. Turbidity is the amount of particulate matter that is suspended in water. Turbidity measures the scattering effect that suspended solids have on light: the higher the intensity of scattered light, the higher the turbidity. Material that causes water to be turbid include: clay, silt, finely divided organic and inorganic matter, soluble colored organic compounds, plankton and microscopic organisms. Conductivity measurement is the same as in the HI7609829-3.



HI7698296

Long cap for probes with EC/turbidity sensor



**FastTracker™**  
location traceability



### Fast Tracker™ –Tag Identification System

HANNA's Fast Tracker™–Tag Identification System simplifies test logging. iButton®s with a unique ID can be installed at various sampling sites. When the matching connector on the meter contacts the location button, measurements are logged and labeled with the alphanumeric user-entered location ID. Location, date, time and measurements are logged into the meter which can be transferred to a PC. The Fast Tracker™ system complements the GPS for ultimate tracking.

### iButton® Tags are Easy to Install

Install the optional TAGs near your sampling points for quick and easy iButton® readings. Each TAG contains a computer chip with a unique identification code encased in stainless steel. You can install a practically unlimited amount of TAGs. Additional TAGs can be ordered for all of your traceability requirements.

\*Google™ is a registered trademark of Google™, inc. HANNA Instruments® has no affiliation with Google™.

## Monitoring and Tracking

The HI9829 with GPS module can track measurement locations with detailed coordinate information. All models of the HI9829 are equipped with the Fast Tracker™ TAG ID system which is an invaluable tool for associating measurements with their locations. The HI9829 also incorporates a real-time clock which stamps all logged data with a time and date in addition to location information.

## GPS (Global Positioning System)

The HI9829 with GPS features an internal 12 channel GPS receiver and antenna that calculates its position to track locations along with measurement data. The GPS tracks your location using satellites to within 30 ft (10 m) so you can be sure that you return to the same location for repeated measurements. The GPS coordinates can be shown on the LCD together with up to 10 measurement parameters and are recorded with logged data. Users can connect to GPS tracking software such as Google™ Maps\* to view locations where samples have been taken. Measurement information is shown right on the map.

## Features

- **Basic GPS Features**
  - GPS coordinates shown on the LCD with up to 10 measurement parameters
  - GPS signal strength shown on LCD
  - Logged data is embedded with GPS coordinates
  - GPS status screen
- **Advanced GPS Features**
  - Users can associate GPS coordinates with alphanumeric locations
  - Distances between current location and predefined locations are displayed arranged by distance
  - Memorizes last location and time should signal be lost
- **HI929829 PC Application Software**
  - Manages logged data from the HI9829
  - Displays GPS coordinates with logged data
  - Automatically maps samples on your PC (internet connection required)
  - Shows location points on map with measurement data

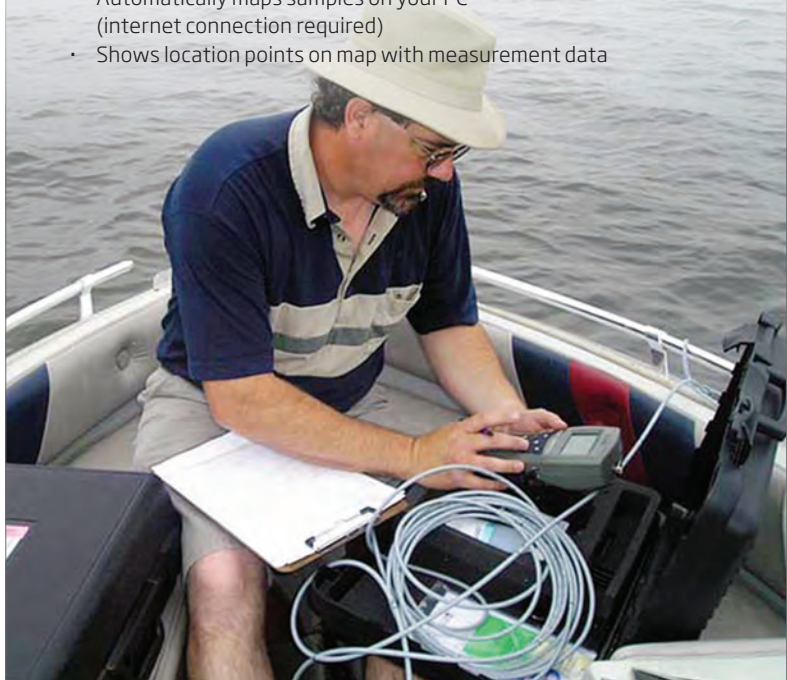

## GPS Screen Features

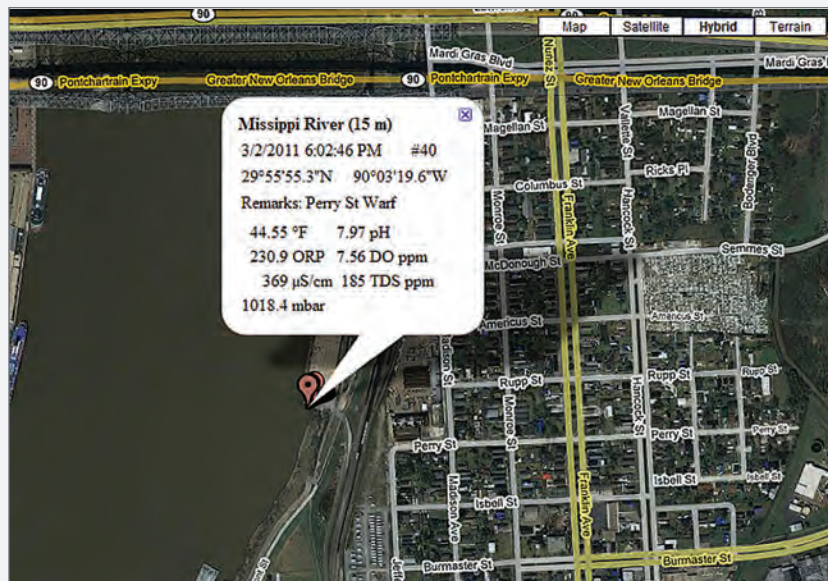

- GPS data can be customized to meet specific requirement



- Displays distances between current and predefined locations

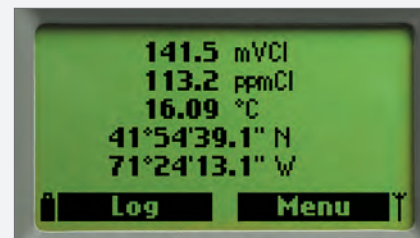

- Display current readings along with GPS coordinates

Measurement log data - LOG005.LOG

Type: HI 9829 Fw. Version v1.00b05.6

	Date	Time	Temp.[°C]	pH	ORP[mV]
1	2011.06.08	18:42:17	24.84	6.27	45.4
2	2011.06.08	18:42:22	24.84	6.27	45.4
3	2011.06.08	18:42:27	24.78	6.29	46.2
4	2011.06.08	18:42:32	24.73	6.25	43.6
5	2011.06.08	18:42:37	26.93	7.36	12.9
6	2011.06.08	18:42:42	29.66	7.38	12.3
7	2011.06.08	18:42:47	29.71	7.41	12.2
8	2011.06.08	18:42:52	29.73	7.45	13.1
9	2011.06.08	18:42:57	29.78	7.49	13.4
10	2011.06.08	18:43:02	29.54	7.45	17.3
11	2011.06.08	18:43:07	29.73	7.58	14.4
12	2011.06.08	18:43:12	29.76	7.60	14.6
13	2011.06.08	18:43:17	29.76	7.62	14.7
14	2011.06.08	18:43:22	29.75	7.63	15.0
15	2011.06.08	18:43:27	29.73	7.63	15.8
16	2011.06.08	18:43:32	29.74	7.64	16.1
17	2011.06.08	18:43:37	29.74	7.65	16.2
18	2011.06.08	18:43:42	29.73	7.66	16.4
19	2011.06.08	18:43:47	29.70	7.66	17.3
20	2011.06.08	18:43:52	29.72	7.67	17.0
21	2011.06.08	18:43:57	29.73	7.68	17.0
22	2011.06.08	18:44:02	29.71	7.68	17.2
23	2011.06.08	18:47:35	26.52	6.52	47.7

Export Print Graphic Log Close Help Map

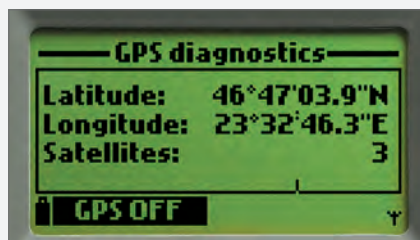

- Shows current position and number of satellites

Specifications	HI9829	HI9829 with GPS
Temperature Compensation	automatic from -5 to 55°C (23 to 131°F)	automatic from -5 to 55°C (23 to 131°F)
GPS	–	12 channel receiver, 10 m (30 ft) range
Logging Memory from Meter	44,000 records	44,000 records
Logging Interval	1 second to 3 hours	1 second to 3 hours
Computer Interface	USB (with HI 929829 software)	USB (with HI929829 software)
FastTracker™ TAG ID	Yes	Yes
Waterproof Protection	IP67	IP67
Environment	0 to 50°C (32 to 122°F); RH 100%	0 to 50°C (32 to 122°F); RH 100%
Power Supply	1.5V alkaline C cells (4) / 1.2V NiMH rechargeable C cells (4), USB, 12V power adapter	1.5V alkaline C cells (4) / 1.2V NiMH rechargeable C cells (4), USB, 12V power adapter
Dimensions	221 x 115 x 55 mm (8.7 x 4.5 x 2.2")	221 x 115 x 55 mm (8.7 x 4.5 x 2.2")
Weight	750g (26.5 oz.)	750g (26.5 oz.)

### HI9829 Parameter Specifications

	pH / mV of pH input	ORP mV	Ammonium-Nitrogen	Chloride	Nitrate-Nitrogen
Range	0.00 to 14.00 pH / ±600.0 mV	±2000.0 mV	0.02 to 200 ppm (as N)	0.6 to 200 ppm	0.62 to 200 ppm (as N)
Resolution	0.01 pH / 0.1 mV	0.1 mV	0.01 ppm to 1 ppm; 0.1 ppm to 200 ppm		
Accuracy	±0.02 pH / ±0.5 mV	±1.0 mV	±5% of reading or 2 ppm, whichever is greater		
Calibration	automatic one, two, or three points with five memorized standard buffers (pH 4.01, 6.86, 7.01, 9.18, 10.01) or one custom buffer	automatic at one custom point	1 or 2 point, 10 ppm and 100 ppm		

	Conductivity	TDS	Resistivity	Salinity	Seawater $\sigma$
Range	0 to 200 mS/cm (absolute EC up to 400 mS/cm)	0 to 400000 mg/L or ppm (the maximum value depends on the TDS factor)	0 to 999999 $\Omega$ •cm; 0 to 1000.0 k $\Omega$ •cm; 0 to 1.0000 M $\Omega$ •cm	0.00 to 70.00 PSU	0 to 50.0 $\sigma$ T, $\sigma$ 0, $\sigma$ 15
Resolution	<b>manual:</b> 1 $\mu$ S/cm; 0.001 mS/cm; 0.01 mS/cm; 0.1 mS/cm; 1 mS/cm; <b>automatic:</b> 1 $\mu$ S/cm from 0 to 9999 $\mu$ S/cm; 0.01 mS/cm from 10.00 to 99.99 mS/cm; 0.1 mS/cm from 100.0 to 400.0 mS/cm; <b>automatic mS/cm:</b> 0.001 mS/cm from 0.000 to 9.999 mS/cm; 0.01 mS/cm from 10.00 to 99.99 mS/cm; 0.1 mS/cm from 100.0 to 400.0 mS/cm	<b>manual:</b> 1 mg/L (ppm); 0.001 g/L (ppt); 0.01 g/L (ppt); 0.1 g/L (ppt); 1 g/L (ppt); <b>automatic:</b> 1 mg/L (ppm) from 0 to 9999 mg/L (ppm); 0.01 g/L (ppt) from 10.00 to 99.99 g/L (ppt); 0.1 g/L (ppt) from 100.0 to 400.0 g/L (ppt); <b>autorange g/L (ppt) scales:</b> 0.001 g/L (ppt) from 0.000 to 9.999 g/L (ppt); 0.01 g/L (ppt) from 10.00 to 99.99 g/L (ppt); 0.1 g/L (ppt) from 100.0 to 400.0 g/L (ppt)	dependent on resistivity reading	0.01 PSU	0.1 $\sigma$ T, $\sigma$ 0, $\sigma$ 15
Accuracy	±1% of reading or ±1 $\mu$ S/cm, whichever is greater	±1% of reading or ±1 mg/L, whichever is greater	–	±2% of reading or ±0.01 PSU, whichever is greater	±1 $\sigma$ T, $\sigma$ 0, $\sigma$ 15
Calibration	automatic one point with six memorized standards (84 $\mu$ S/cm, 1413 $\mu$ S/cm, 5.00 mS/cm, 12.88 mS/cm, 80.0 mS/cm, 111.8 mS/cm) or custom point	based on conductivity or salinity calibration		one custom point	based on conductivity or salinity calibration

	Turbidity	Dissolved Oxygen	Atm. Pressure	Temperature
Range	0.0 to 99.9 FNU; 100 to 1000 FNU	0.0 to 500.0%; 0.00 to 50.00 ppm	450 to 850 mm Hg; 17.72 to 33.46 in Hg; 600.0 to 1133.2 mbar; 8.702 to 16.436 psi; 0.5921 to 1.1184 atm; 60.00 to 113.32 kPa	-5.00 to 55.00°C; 23.00 to 131.00°F; 268.15 to 328.15K
Resolution	0.1 FNU from 0.0 to 99.9 FNU; 1 FNU from 100 to 1000 FNU	0.1%; 0.01 ppm	0.1 mm Hg; 0.01 in Hg; 0.1 mbar; 0.001 psi; 0.0001 atm; 0.01 kPa	0.01°C; 0.01°F; 0.01K
Accuracy	±0.3 FNU or ±2% of reading, whichever is greater	0.0 to 300.0%: ±1.5% of reading or ±1.0% whichever is greater; 300.0 to 500.0%: ±3% of reading; 0.00 to 30.00 ppm: ±1.5% of reading or 0.10 ppm, whichever is greater; 30.00 ppm to 50.00 ppm: ±3% of reading	±3 mm Hg within ±15°C from the temperature during calibration	±0.15°C; ±0.27°F; ±0.15K
Calibration	Automatic 1, 2 or 3 points at 0, 20 and 200 FNU, or custom	automatic one or two points at 0, 100% or one custom point	automatic at one custom point	Automatic at one custom point

## Ordering Information

Meter and Probe with Rugged Carrying Case

# HI9829 - [w] [x] [y] [z]



W=	0	Basic meter, no GPS
	1	Meter with GPS
X=	0	No turbidity basic probe
	1	Turbidity basic probe
	2	Autonomously logging probe, no turbidity
Y=	04	4 meter cable length
	10	10 meter cable length
Z=	1	115V
	2	230V

z=1 is supplied with 115V AC to 12V DC Adapter  
z=2 is supplied with 230V AC to 12V DC Adapter

### All HI9829 Kits Include:

- HI9829 or HI 98290 (GPS Model)
- HI710140 Hard carrying case
- HI710005/8 (115V) or HI710006/8 (230V) Multiparameter Probe (see table)
- HI7698292 Probe Maintenance Kit
- HI929829 Application Software
- HI7698291 USB cable (PC to meter)
- HI710045 Power supply cable
- HI710046 Cigarette lighter cable
- HI7609829-1 pH/ORP sensor
- HI7609829-2 Galvanic DO Sensor
- HI920005 iButton® with holder (5 pcs)
- HI9828-25 Calibration solution
- Instruction Manual

### Optional Kit Components:

- HI7609829-12 Nitrate sensor
- HI7609829-11 Chloride ISE sensor
- HI7609829-10 Ammonium ISE sensor
- HI7698297 Long quick release flow cell Spare Solution (see below)

### Kit Specific Components:

Kit Number	Probe	HI7609829-3 EC Sensor	HI7698290 Short calibration beaker	HI7609829-4 EC / Turbidity Sensor	HI7698293 Long calibration beaker	HI9829-16 0 FNU calibration solution	HI9829-17 20 FNU calibration solution	HI9829-18 200 FNU calibration solution	HI76982910 USB cable (PC to Probe)	HI7698295 Short protective sleeve	HI7698296 long protective sleeve
HI9829-0004Z	HI7609829/4	•	•							•	
HI9829-0010Z	HI7609829/10	•	•							•	
HI9829-0020Z	HI7609829/20	•	•							•	
HI9829-0104Z	HI7609829/4			•	•	•	•	•			•
HI9829-0110Z	HI7609829/10			•	•	•	•	•			•
HI9829-0120Z	HI7609829/20			•	•	•	•	•			•
HI9829-0204Z	HI7629829/4	•	•						•	•	
HI9829-0210Z	HI7629829/10	•	•						•	•	
HI9829-0220Z	HI7629829/20	•	•						•	•	
HI9829-0304Z	HI7629829/4			•	•	•	•	•	•	•	•
HI9829-0310Z	HI7629829/10			•	•	•	•	•	•	•	•
HI9829-0320Z	HI7629829/20			•	•	•	•	•	•	•	•
HI9829-1004Z	HI7609829/4	•	•							•	
HI9829-1010Z	HI7609829/10	•	•							•	
HI9829-1020Z	HI7609829/20	•	•							•	
HI9829-1104Z	HI7609829/4			•	•	•	•	•			•
HI9829-1110Z	HI7609829/10			•	•	•	•	•			•
HI9829-1120Z	HI7609829/20			•	•	•	•	•			•
HI9829-1204Z	HI7629829/4	•	•						•	•	
HI9829-1210Z	HI7629829/10	•	•						•	•	
HI9829-1220Z	HI7629829/20	•	•						•	•	
HI9829-1304Z	HI7629829/4			•	•	•	•	•	•	•	•
HI9829-1310Z	HI7629829/10			•	•	•	•	•	•	•	•
HI9829-1320Z	HI7629829/20			•	•	•	•	•	•	•	•

### Spare Solution

HI9829-10	25 sachets 10ppm ammonia-nitrogen calibration solution
HI9829-10/11	10 sachets each of 10ppm and 100ppm ammonia-nitrogen calibration solution
HI9829-11	25 sachets 100ppm ammonia-nitrogen calibration solution
HI9829-12	25 sachets 10ppm chloride calibration solution
HI9829-12/13	10 sachets each of 10ppm and 100ppm chloride calibration solution
HI9829-13	25 sachets 100ppm chloride calibration solution
HI9829-14	25 sachets 10ppm nitrate-nitrogen calibration solution
HI9829-14/15	10 sachets each of 10ppm and 100ppm nitrate-nitrogen calibration solution
HI9829-15	25 sachets 100ppm nitrate-nitrogen calibration solution



# Meter with Probe Ordering Information

Choose Your Configuration Below

## Meter and Logging Probe with Rugged Carrying Case

Basic with Autonomously Logging Probe	<b>HI9829-02041</b> (115V) <b>HI9829-02042</b> (230V)	HI9829 meter, HI7629829/4 probe, HI76982910 USB cable (PC to Probe), HI7698291 USB cable (PC to meter), HI929829 PC application software, HI920005 iButton® with holder (5 pcs), HI7609829-3 EC sensor, HI7609829-2 DO sensor, HI7609829-1 pH/ORP sensor, HI710045 power supply cable, HI7698290 short calibration beaker, HI9828-25 calibration solution (500 mL), HI710005/8 (115V) or HI710006/8 (230V), instruction manual.
	<b>HI9829-02101</b> (115V) <b>HI9829-02102</b> (230V)	HI9829 meter, HI7629829/10 probe, HI76982910 USB cable (PC to Probe), HI7698291 USB cable (PC to meter), HI929829 PC application software, HI920005 iButton® with holder (5 pcs), HI7609829-3 EC sensor, HI7609829-2 DO sensor, HI7609829-1 pH/ORP sensor, HI710045 power supply cable, HI7698290 short calibration beaker, HI9828-25 calibration solution (500 mL), HI710005/8 (115V) or HI710006/8 (230V), instruction manual.
	<b>HI9829-02201</b> (115V) <b>HI9829-02202</b> (230V)	HI9829 meter, HI7629829/20 probe, HI76982910 USB cable (PC to Probe), HI7698291 USB cable (PC to meter), HI929829 PC application software, HI920005 iButton® with holder (5 pcs), HI7609829-3 EC sensor, HI7609829-2 DO sensor, HI7609829-1 pH/ORP sensor, HI710045 power supply cable, HI7698290 short calibration beaker, HI9828-25 calibration solution (500 mL), HI710005/8 (115V) or HI710006/8 (230V), instruction manual.
GPS with Autonomously Logging Probe	<b>HI9829-12041</b> (115V) <b>HI9829-12042</b> (230V)	HI9829 meter with GPS, HI7629829/4 probe, HI76982910 USB cable (PC to Probe), HI7698291 USB cable (PC to meter), HI929829 PC application software, HI920005 iButton® with holder (5 pcs), HI7609829-3 EC sensor, HI7609829-2 DO sensor, HI7609829-1 pH/ORP sensor, HI710045 power supply cable, HI7698290 short calibration beaker, HI9828-25 calibration solution (500 mL), HI710005/8 (115V) or HI710006/8 (230V), instruction manual.
	<b>HI9829-12101</b> (115V) <b>HI9829-12102</b> (230V)	HI9829 meter with GPS, HI7629829/10 probe, HI76982910 USB cable (PC to Probe), HI7698291 USB cable (PC to meter), HI929829 PC application software, HI920005 iButton® with holder (5 pcs), HI7609829-3 EC sensor, HI7609829-2 DO sensor, HI7609829-1 pH/ORP sensor, HI710045 power supply cable, HI7698290 short calibration beaker, HI9828-25 calibration solution (500 mL), HI710005/8 (115V) or HI710006/8 (230V), instruction manual.
	<b>HI9829-12201</b> (115V) <b>HI9829-12202</b> (230V)	HI9829 meter with GPS, HI7629829/20 probe, HI76982910 USB cable (PC to Probe), HI7698291 USB cable (PC to meter), HI929829 PC application software, HI920005 iButton® with holder (5 pcs), HI7609829-3 EC sensor, HI7609829-2 DO sensor, HI7609829-1 pH/ORP sensor, HI710045 power supply cable, HI7698290 short calibration beaker, HI9828-25 calibration solution (500 mL), HI710005/8 (115V) or HI710006/8 (230V), instruction manual.
Basic with Autonomously Logging Probe & Turbidity	<b>HI9829-03041</b> (115V) <b>HI9829-03042</b> (230V)	HI9829 meter, HI7629829/4 probe, HI76982910 USB cable (PC to Probe), HI7698291 USB cable (PC to meter), HI929829 PC application software, HI920005 iButton® with holder (5 pcs), HI7609829-2 DO sensor, HI7609829-1 pH/ORP sensor, HI7609829-4 EC/Turbidity sensor, HI710045 power supply cable, HI7698292 probe maintenance kit, HI9829-16 0 FNU calibration solution (230 mL), HI9829-17 20 FNU calibration solution (230 mL), HI9829-18 200 FNU calibration solution (230 mL), HI7698293 long calibration beaker, HI9828-25 calibration solution (500 mL), HI710046 cigarette lighter cable, HI710005/8 (115V) or HI710006/8 (230V), instruction manual.
	<b>HI9829-03101</b> (115V) <b>HI9829-03102</b> (230V)	HI9829 meter, HI7629829/10 probe, HI76982910 USB cable (PC to Probe), HI7698291 USB cable (PC to meter), HI929829 PC application software, HI920005 iButton® with holder (5 pcs), HI7609829-2 DO sensor, HI7609829-1 pH/ORP sensor, HI7609829-4 EC/Turbidity sensor, HI710045 power supply cable, HI7698292 probe maintenance kit, HI9829-16 0 FNU calibration solution (230 mL), HI9829-17 20 FNU calibration solution (230 mL), HI9829-18 200 FNU calibration solution (230 mL), HI7698293 long calibration beaker, HI9828-25 calibration solution (500 mL), HI710046 cigarette lighter cable, HI710005/8 (115V) or HI710006/8 (230V), instruction manual.
	<b>HI9829-03201</b> (115V) <b>HI9829-03202</b> (230V)	HI9829 meter, HI7629829/20 probe, HI76982910 USB cable (PC to Probe), HI7698291 USB cable (PC to meter), HI929829 PC application software, HI920005 iButton® with holder (5 pcs), HI7609829-2 DO sensor, HI7609829-1 pH/ORP sensor, HI7609829-4 EC/Turbidity sensor, HI710045 power supply cable, HI7698292 probe maintenance kit, HI9829-16 0 FNU calibration solution (230 mL), HI9829-17 20 FNU calibration solution (230 mL), HI9829-18 200 FNU calibration solution (230 mL), HI7698293 long calibration beaker, HI9828-25 calibration solution (500 mL), HI710046 cigarette lighter cable, HI710005/8 (115V) or HI710006/8 (230V), instruction manual.
GPS with Autonomously Logging Probe & Turbidity	<b>HI9829-13041</b> (115V) <b>HI9829-13042</b> (230V)	HI9829 meter with GPS, HI7629829/4 probe, HI76982910 USB cable (PC to Probe), HI7698291 USB cable (PC to meter), HI929829 PC application software, HI920005 iButton® with holder (5 pcs), HI7609829-2 DO sensor, HI7609829-1 pH/ORP sensor, HI7609829-4 EC/Turbidity sensor, HI710045 power supply cable, HI7698292 probe maintenance kit, HI9829-16 0 FNU calibration solution (230 mL), HI9829-17 20 FNU calibration solution (230 mL), HI9829-18 200 FNU calibration solution (230 mL), HI7698293 long calibration beaker, HI9828-25 calibration solution (500 mL), HI710046 cigarette lighter cable, HI710005/8 (115V) or HI710006/8 (230V), instruction manual.
	<b>HI9829-13101</b> (115V) <b>HI9829-13102</b> (230V)	HI9829 meter with GPS, HI7629829/10 probe, HI76982910 USB cable (PC to Probe), HI7698291 USB cable (PC to meter), HI929829 PC application software, HI920005 iButton® with holder (5 pcs), HI7609829-2 DO sensor, HI7609829-1 pH/ORP sensor, HI7609829-4 EC/Turbidity sensor, HI710045 power supply cable, HI7698292 probe maintenance kit, HI9829-16 0 FNU calibration solution (230 mL), HI9829-17 20 FNU calibration solution (230 mL), HI9829-18 200 FNU calibration solution (230 mL), HI7698293 long calibration beaker, HI9828-25 calibration solution (500 mL), HI710046 cigarette lighter cable, HI710005/8 (115V) or HI710006/8 (230V), instruction manual.
	<b>HI9829-13201</b> (115V) <b>HI9829-13202</b> (230V)	HI9829 meter with GPS, HI7629829/20 probe, HI76982910 USB cable (PC to Probe), HI7698291 USB cable (PC to meter), HI929829 PC application software, HI920005 iButton® with holder (5 pcs), HI7609829-2 DO sensor, HI7609829-1 pH/ORP sensor, HI7609829-4 EC/Turbidity sensor, HI710045 power supply cable, HI7698292 probe maintenance kit, HI9829-16 0 FNU calibration solution (230 mL), HI9829-17 20 FNU calibration solution (230 mL), HI9829-18 200 FNU calibration solution (230 mL), HI7698293 long calibration beaker, HI9828-25 calibration solution (500 mL), HI710046 cigarette lighter cable, HI710005/8 (115V) or HI710006/8 (230V), instruction manual.

## Meter Only

Basic	<b>HI9829-01</b> (115V) <b>HI9829-02</b> (230V)	HI9829 meter only
GPS	<b>HI98290-01</b> (115V) <b>HI98290-02</b> (230V)	HI9829 meter with GPS only



**HI9828-27**  
Quick calibration solution,  
1 gallon

## Probe Only, No Sensors

<b>HI7609829/4</b>	Probe for pH/pH+ORP/ISE, DO, EC, temperature with HI7698295 short protective shield and 4 m (13.1') cable
<b>HI7609829/10</b>	Probe for pH/pH+ORP/ISE, DO, EC, temperature with HI7698295 short protective shield and 10 m (33') cable
<b>HI7609829/20</b>	Probe for pH/pH+ORP/ISE, DO, EC, temperature with HI7698295 short protective shield and 20 m (65.6') cable
<b>HI7629829/4</b>	Logging probe for pH/pH+ORP/ISE, DO, EC, temperature with HI7698295 short protective shield and 4 m (13.1') cable
<b>HI7629829/10</b>	Logging probe for pH/pH+ORP/ISE, DO, EC, temperature with HI7698295 short protective shield and 10 m (33') cable
<b>HI7629829/20</b>	Logging probe for pH/pH+ORP/ISE, DO, EC, temperature with HI7698295 short protective shield and 20 m (65.6') cable

## Sensors with O-Ring

<b>HI7609829-1</b>	pH/ORP
<b>HI7609829-2</b>	Dissolved Oxygen
<b>HI7609829-3</b>	EC
<b>HI7609829-4</b>	EC/Turbidity
<b>HI7609829-10</b>	Ammonium ISE
<b>HI7609829-11</b>	Chloride ISE
<b>HI7609829-12</b>	Nitrate ISE

## Quick Calibration Solutions

<b>HI9828-25</b>	Quick calibration solution, 500 mL
<b>HI9828-27</b>	Quick calibration solution, 1 gal

## pH Calibration Solutions

<b>HI7004L</b>	pH 4.01 buffer solution, 500 mL
<b>HI7007L</b>	pH 7.01 buffer solution, 500 mL
<b>HI7010L</b>	pH 10.01 buffer solution, 500 mL

## ORP Calibration Solutions

<b>HI7021L</b>	ORP test solution @240 mV, 500 mL
<b>HI7022L</b>	ORP test solution @470 mV, 500 mL

## EC Calibration Solutions

<b>HI7030L</b>	12880 $\mu$ S/cm cal. sol., 500 mL
<b>HI7031L</b>	1413 $\mu$ S/cm cal. sol., 500 mL
<b>HI7033L</b>	84 $\mu$ S/cm cal. sol., 500 mL
<b>HI7034L</b>	80000 $\mu$ S/cm cal. sol., 500 mL
<b>HI7035L</b>	111800 $\mu$ S/cm cal. sol., 500 mL
<b>HI7039L</b>	5000 $\mu$ S/cm cal. sol., 500 mL

## Dissolved Oxygen Solutions

<b>HI7040L</b>	Zero oxygen solution, 500 mL
<b>HI7042S</b>	Electrolyte solution, 30 mL



## Turbidity Calibration Solutions

HI9829-16	0 FNU calibration solution, 230 mL
HI9829-17	20 FNU calibration solution, 230 mL
HI9829-18	200 FNU calibration solution, 230 mL

## ISE Standards

HI9829-10/11	Kit containing 10 sachets each of 10 ppm and 100 ppm standard for HI7609829-10 ammonium ISE
HI9829-10	10 ppm standard sachet for HI7609829-10 ammonium ISE, 20 mL (25)
HI9829-11	100 ppm standard sachet for HI7609829-10 ammonium ISE, 20 mL (25)
HI9829-12/13	Kit containing 10 sachets each of 10 ppm and 100 ppm standard for HI7609829-11 chloride ISE
HI9829-12	10 ppm standard sachet for HI7609829-11 chloride ISE, 20 mL (25)
HI9829-13	100 ppm standard sachet for HI7609829-11 chloride ISE, 20 mL (25)
HI9829-14/15	Kit containing 10 sachets each of 10 ppm and 100 ppm standard for HI7609829-12 nitrate ISE
HI9829-14	10 ppm standard sachet for HI7609829-12 nitrate ISE, 20 mL (25)
HI9829-15	100 ppm standard sachet for HI7609829-12 nitrate ISE, 20 mL (25)

## Probe Maintenance Kit

HI7698292	Probe maintenance kit consisting of HI70425 (electrolyte solution for DO sensor), O-rings for DO sensor (5), small brush, O-rings for probe (5), and syringe with grease to lubricate the O-rings.
-----------	--

## pH/ORP Cleaning and Storage Solutions

HI70300L	pH/ORP electrode storage sol., 500 mL
HI7061L	pH/ORP electrode cleaning sol., 500 mL

## Accessories

HI929829	PC application software
HI7698291	USB cable, PC to meter
HI76982910	USB cable, PC to probe
HI710046	Car accessory port cable
HI7698290	Short calibration beaker
HI7698293	Long calibration beaker
HI7698297	Quick Release Flow Cell
HI7698294	Short flow cell
HI7698297	Long, quick release flow cell
HI7698295	Short protective shield
HI7698296	Long protective shield
HI920005	iButton® with holder (5 pcs)
HI710140	Hard carrying case
HI710045	Power supply cable



**HI76982910**  
USB cable, PC to probe



**HI710046**  
Car accessory port cable



**HI7698292**  
Probe maintenance kit



**HI7698297**  
Long, quick release flow cell

HI98494

# Multiparameter Bluetooth® pH/EC/OPDO® Meter

pH, ORP, EC, TDS, Resistivity, Salinity,  
Seawater  $\sigma$ , Dissolved Oxygen, Atmospheric  
Pressure and Temperature

- **Bluetooth connectivity**
  - Retrieve data logs with Hanna Lab app for either sending by e-mail or download to a smart device for review
- **Waterproof**
  - IP67 rated waterproof, rugged enclosure for meter, IP68 for probe
- **Digital probe**
  - Digital probe with built-in temperature sensor and three ports for pH (ORP), EC and optical DO sensors
  - Color coded, field replaceable sensors
  - Auto-sensor recognition
  - Stainless steel, weighted protective guard
- **Quick calibration feature**
- **Automatic barometric pressure compensation**
- **Automatic temperature compensation**
- **Logging**
  - Automatic interval logging of up to 45,000 samples
  - Log-on-demand to store measurement data
- **GLP**
  - GLP data provides data from previous five calibrations to ensure Good Laboratory Practices are met
- **Dedicated help key**
  - On-screen context specific help is readily available at the press of a button
- **Backlit LCD display with multifunction virtual keys**
- **Intuitive keypad**
  - Dedicated and virtual soft keys
- **USB type-C**
  - Computer connectivity for transferring logged data as .CSV file
  - Port used for recharging built-in lithium-ion battery
- **Dual power source**
  - Meter operates on built-in lithium-ion battery
  - Meter automatically switches to common alkaline batteries as backup power source



Stainless steel, weighted  
protective guard

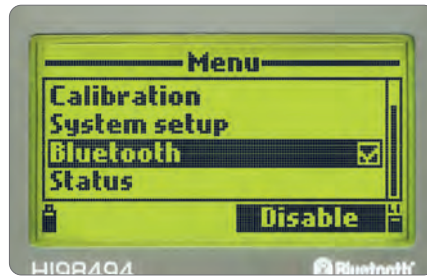

HI98494 offers the ability to connect wirelessly to a smart device running the Hanna Lap App. Using the app, log lots can be e-mailed or downloaded for review.

## Measurements

HI98494 can display from 1 to 12 parameters on the high contrast backlit LCD. The pH, EC and DO measurements are automatically compensated for temperature variations. Dissolved oxygen measurements are automatically compensated for barometric pressure and salinity.

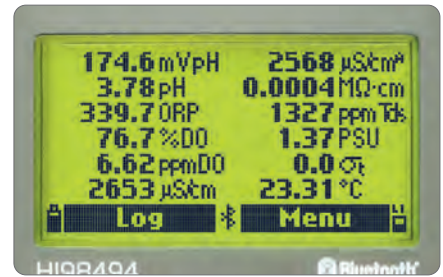
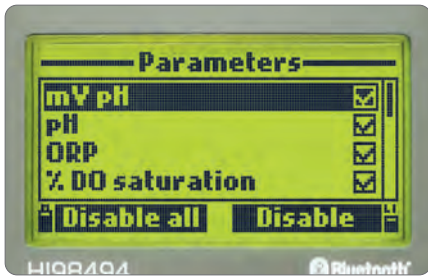

## Data Logging

HI98494 can be used to log one data point or do interval logging for continuous logging at a specified interval. All logs have the option to store data into a named lot and the ability to add remarks. Both help to provide for meaningful data including notes on local environmental conditions.

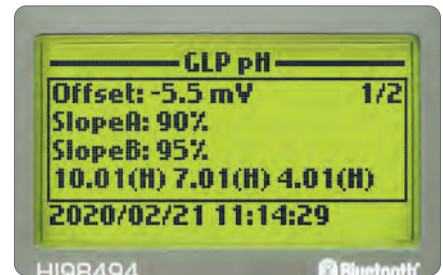
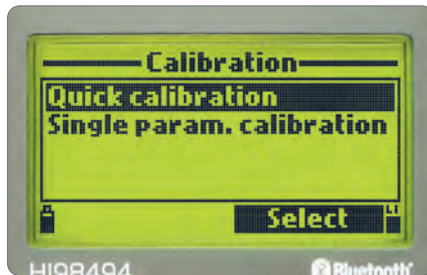

## Dual Power Source

The meter operates on a built-in lithium-ion battery. When the rechargeable battery is low the meter will automatically switch to the 1.5 AA alkaline batteries.

## Quick-Calibration

Quick Calibration provides a speedy, single point calibration for pH, conductivity, and dissolved oxygen. Standard calibration options are available including pH up to three points, conductivity at one point and dissolved oxygen up to two points.

## GLP Data

Calibration information is captured along with time and date stamp. Information includes calibration values along with other values that have an impact on the measurement. GLP data is stored with logged data.

# Bluetooth® and Hanna Lab App Compatibility

Using the Bluetooth connection the data can be transferred to a smart device for review or shared as an e-mail.

Multiparameter



portable

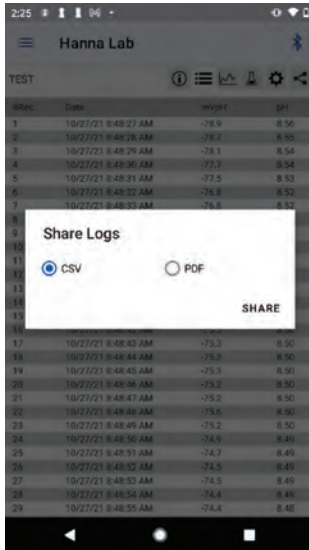

## Share

Logs can be shared as a .CSV or .PDF file when being e-mailed.



## GLP

Comprehensive GLP data can be reviewed for all parameters when the logged data is downloaded to a smart device.



## Unit Selection

When reviewing data on a smart device there is an option to select the measurement units to be displayed independently of the meter settings.

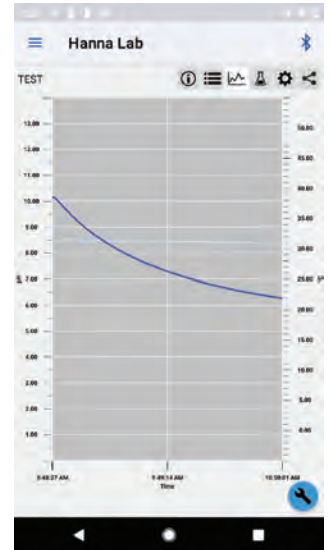

## Data Graphing

For trend analysis the Hanna Lab App offers the option to graph logged data.

# Multiparameter Probe and Sensors

## Multi-function Sensor

- Quick sensor replacement
  - Sensor replacement is quick and easy with field replaceable, screw type connectors and are color coded for easy identification. These meters automatically recognize sensors.



Easy sensor removal with hex key

Probe Specifications	HI7698494
Sensor Inputs	three (pH or pH/ORP, DO, EC)
Sample Environment	fresh, brackish, seawater
Waterproof Protection	IP68
Operating Temperature	-5 to 55°C
Storage Temperature	-20 to 70°C
Maximum Depth	20 m (66')
Dimensions (without cable)	342 mm (13.5"); 46 mm (1.8") dia
Weight (without sensors)	570 g (20.1 oz.)
Cable Specification	multistrand-multiconductor shielded cable with internal strength member rated for 68 kg (150 lb.) intermittent use
	Body ABS
	Threads Nylon
Wetted Materials	Shield ABS / 316 SS
	Temperature Probe 316 SS
	O-rings EPDM

### Optical Dissolved Oxygen Smart Caps

The optical dissolved oxygen sensor uses a smart cap that has an RFID tag that stores calibration coefficients unique to each cap. The RFID keeps track of the age of the cap and alerts the user when it should be replaced.



Sensor Specifications	HI7698194-0	HI7698194-1	HI7698194-3	HI7698494-5	
Description	pH sensor	pH/ORP sensor	EC sensor	optical; luminescence quenching DO sensor	
Measurement Type	pH, mV (pH)	pH, mV (pH), ORP	EC	DO (% saturation and concentration)	
Measurement Range	0.00 to 13.00 pH; ±600.0 mV	0.00 to 13.00 pH; ±600.0 mV; ±2000.0 mV	0.0 to 200.0 mS/cm; 0.0 to 400 mS/cm (absolute)	0.0 to 500.0 %; 0.00 to 50.00 mg/L	
Temperature Range	-5 to 55°C	-5 to 55°C	-5 to 55°C	-5 to 55°C	
Color Code	red	red	blue	green	
Materials	Tip	glass (pH)	glass (pH); Pt (ORP)	polypropylene	
	Glass Type	LT (low temperature)	LT (low temperature)	-	
	Junction	ceramic	ceramic	-	
	Body	PEI	PEI	ABS/epoxy	ABS
	Electrolyte	gel	gel	-	-
Reference	double	double	-	-	
Maintenance Solution	HI70300 (storage solution)	HI70300 (storage solution)	none	none	
Dimensions	118 x 15 mm	118 x 15 mm	111 x 17 mm	99 x 17 mm	
Depth	20 m (65')	20 m (65')	20 m (65')	20 m (65')	



### Data Transfer & Charging

The USB Type-C port provides for easy data transfer to memory stick, PC, or other compatible devices and is used to charge internal lithium-ion battery.

## Waterproof Probe Connection and USB Type-C

### Waterproof Quick Connect DIN Connector

The meter connects to the multiparameter probe through a single waterproof connector and makes attaching and removing the probe quick and easy. The meter automatically detects the probe when connected.

Specifications	HI98494	
pH / mV	Range	0.00 to 14.00 pH / $\pm 600.0$ mV
	Resolution	0.01 pH / 0.1 mV
	Accuracy	$\pm 0.02$ pH / $\pm 0.5$ mV
	Calibration	automatic one-point Quick Calibration using HI9828-25; automatic one, two, or three points with automatic recognition of five standard buffers (pH 4.01, 6.86, 7.01, 9.18, 10.01) or one custom buffer
ORP	Range	$\pm 2000.0$ mV
	Resolution	0.1 mV
	Accuracy	$\pm 1.0$ mV
	Calibration	manual at one custom point (relative mV)

EC	Range	0 to 200 mS/cm (absolute EC up to 400 mS/cm)
	Resolution	<b>manual:</b> 1 $\mu$ S/cm; 0.001 mS/cm; 0.01 mS/cm; 0.1 mS/cm; 1 mS/cm; <b>automatic:</b> 1 $\mu$ S/cm from 0 to 9999 $\mu$ S/cm; 0.01 mS/cm from 10.00 to 99.99 mS/cm; 0.1 mS/cm from 100.0 to 400.0 mS/cm; <b>automatic (mS/cm):</b> 0.001 mS/cm from 0.000 to 9.999 mS/cm; 0.01 mS/cm from 10.00 to 99.99 mS/cm; 0.1 mS/cm from 100.0 to 400.0 mS/cm
	Accuracy	$\pm 1\%$ of reading or $\pm 1 \mu$ S/cm whichever is greater
	Calibration	automatic one-point Quick Calibration using HI9828-25 ; automatic single point, with six standard solutions (84 $\mu$ S/cm, 1413 $\mu$ S/cm, 5.00 mS/cm, 12.88 mS/cm, 80.0 mS/cm, 111.8 mS/cm) or custom point
TDS	Range	0.0 to 400.0 ppt (g/L) (the maximum value depends on the TDS factor)
	Resolution	<b>manual:</b> 1 ppm (mg/L); 0.001 ppt (g/L); 0.01 ppt (g/L); 0.1 ppt (g/L); 1 ppt (g/L); <b>automatic:</b> 1 ppm (mg/L) from 0 to 9999 ppm (mg/L); 0.01 ppt (g/L) from 10.00 to 99.99 ppt (g/L); 0.1 ppt (g/L) from 100.0 to 400.0 ppt (g/L); <b>automatic ppt (g/L):</b> 0.001 ppt (g/L) from 0.000 to 9.999 ppt (g/L); 0.01 ppt (g/L) from 10.00 to 99.99 ppt (g/L); 0.1 ppt (g/L) from 100.0 to 400.0 ppt (g/L)
	Accuracy	$\pm 1\%$ of reading or $\pm 1$ ppm (mg/L) whichever is greater
	Calibration	based on conductivity calibration
Resistivity	Range	0 to 999999 $\Omega \cdot \text{cm}$ ; 0 to 1000.0 $\text{k}\Omega \cdot \text{cm}$ ; 0 to 1.0000 $\text{M}\Omega \cdot \text{cm}$
	Resolution	dependent on resistivity reading
	Calibration	based on conductivity calibration
Salinity	Range	0.00 to 70.00 PSU
	Resolution	0.01 PSU
	Accuracy	$\pm 2\%$ of reading or $\pm 0.01$ PSU whichever is greater
	Calibration	based on conductivity calibration
	Compensation	used for DO salinity compensation
Seawater $\sigma$	Range	0.0 to 50.0 $\sigma_t, \sigma_0, \sigma_{15}$
	Resolution	0.1 $\sigma_t, \sigma_0, \sigma_{15}$
	Accuracy	$\pm 1 \sigma_t, \sigma_0, \sigma_{15}$
	Calibration	based on conductivity calibration
Dissolved Oxygen	Range	0.0 to 500.0%; 0.00 to 50.00 ppm (mg/L)
	Resolution	0.1%; 0.01 ppm (mg/L)
	Accuracy	$\pm 1.5\%$ of reading $\pm 0.01$ mg/L for 0.00-20.00mg/L; $\pm 5\%$ of reading for 20.00-50.00mg/L; $\pm 1.5\%$ of reading $\pm 0.1\%$ for 0.0-200.0%; $\pm 5\%$ of reading for 200.0-500.0%
	Calibration	automatic Quick Calibration in water saturated air; one or two-point automatic calibration at 100% and 0%; manual single point using a value entered by the user in % saturation or mg/L
Atmospheric Pressure	Range	450 to 850 mm Hg; 17.72 to 33.46 in Hg; 600.0 to 1133.2 mbar; 8.702 to 16.436 psi; 0.5921 to 1.1184 atm; 60.00 to 113.32 kPa
	Resolution	0.1 mm Hg; 0.01 in Hg; 0.1 mbar; 0.001 psi; 0.0001 atm; 0.01 kPa
	Accuracy	$\pm 3$ mm Hg within $\pm 15^\circ\text{C}$ from calibration temperature
	Calibration	automatic at one custom point
Temperature	Range	-5.00 to 55.00 $^\circ\text{C}$ ; 23.00 to 131.00 $^\circ\text{F}$ ; 268.15 to 328.15K
	Resolution	0.01 $^\circ\text{C}$ ; 0.01 $^\circ\text{F}$ ; 0.01K
	Accuracy	$\pm 0.15^\circ\text{C}$ ; $\pm 0.27^\circ\text{F}$ ; $\pm 0.15\text{K}$
	Calibration	automatic at one custom point
	Temperature Compensation	automatic from -5 to 55 $^\circ\text{C}$ (23 to 131 $^\circ\text{F}$ )
Additional Specifications	Logging Memory	45,000 records interval logging or 25,000 records log-on-demand of all parameters
	Logging Interval	one second to three hours
	Connectivity	Bluetooth <sup>®</sup> using Hanna Lab App; USB-C: Host - save logs to USB stick device - appears as .MSD on computer
	Environment	0 to 50 $^\circ\text{C}$ (32 to 122 $^\circ\text{F}$ ); RH 100% IP67
	Battery Type / Life	1.5V AA batteries (4); built-in Li-ion battery (1) / minimum 200 hours (AA, without backlighting and BLE) minimum 50 hours (Li-ion battery, without backlighting and BLE)
	Dimensions / Weight	185 x 93 x 35.2 mm (7.3 x 3.6 x 1.4") / 400 g (14.2 oz.)
Ordering Information	all models are supplied with: HI7698194-1 pH/ORP sensor, HI7698194-3 EC sensor, HI7698295 short protective probe shield, HI7698494-5 optical DO sensor, HI9828-20 quick calibration solution, zero oxygen solution, HI7698494-2 probe maintenance kit, HI920016 USB type-C cable, HI7698290 calibration beaker, batteries (4), quality certificate, and instruction manual in a rugged carrying case with custom insert.	
	<b>HI98494</b> is supplied with HI7698494 multiparameter probe with 4m (13') cable <b>HI98494/10</b> is supplied with HI7698494/10 multiparameter probe with 10m (33') cable <b>HI98494/20</b> is supplied with HI7698494/20 multiparameter probe with 20m (66') cable <b>HI98494/30</b> is supplied with HI7698494/20 multiparameter probe with 20m (66') cable <b>HI98494/40</b> is supplied with HI7698494/40 multiparameter probe with 40m (131') cable <b>HI98494/50</b> is supplied with HI7698494/40 multiparameter probe with 40m (131') cable	
Accessories	<b>HI710034</b> orange protective rubber boot	
	<b>HI740246</b> ISE and HI7698494 pH Sensor Storage cap (5 pcs.)	

The Bluetooth<sup>®</sup> word mark and logos are registered trademarks owned by Bluetooth SIG, Inc.

HI98194

## Multiparameter Waterproof Meter

pH, ORP, EC, TDS, Resistivity, Salinity, Seawater  $\sigma$ , Dissolved Oxygen, Atmospheric Pressure and Temperature

### pH Features

- **Calibration**
  - Up to a three-point calibration with five standard buffers and one custom buffer available
- **pH in mV option**
  - Useful for diagnostics
- **GLP data**
  - Offset, slope, date, time and buffers used
- **Automatically temperature compensated readings**
- **pH or pH/ORP field replaceable sensors**
  - Gel filled and maintenance free
  - Double junction for reduced contamination of reference cell

### Dissolved Oxygen Features

- **Choice of units**
  - Display units in % saturation or ppm (mg/L)
- **Salinity compensation for saline waters**
  - Manual entry of salinity values
  - Readings compensated for salinity effects
- **Built-in barometer**
  - Automatic compensation for changes in atmospheric pressure
  - User selectable units
- **Temperature compensation**
- **Polarization**
  - Automatic polarization of probe at startup
- **Membrane caps**
  - Ready-to-use HDPE pre-tensioned membrane caps are easy to replace

### EC/TDS/Resistivity Features

- **Calibration**
  - Single-point calibration from six standards
- **Temperature compensation**
  - Automatic Temperature Compensation
  - Configurable temperature coefficient range from 0.00 to 6.00%/°C
  - Choice of reference temperatures at 20 or 25°C
  - Absolute conductivity can be displayed along with the temperature compensated value
- **Auto-ranging**
- **Salinity readings**
  - Practical Salinity Scale (PSU) based on conductivity calibration



The HI98194 is a waterproof portable logging multiparameter meter that monitors up to 12 different water quality parameters. It's multi-sensor probe allows for the measurement of key parameters including pH, ORP, conductivity, dissolved oxygen, and temperature. The probe transmits readings digitally to the meter, where data points can be displayed and logged. The complete system is simple to setup and easy to use.



## Backlit Graphic LCD Display

The HI98194 features a backlit graphic LCD with on-screen help and the capability to display up to twelve parameters simultaneously. The graphic display allows for the use of virtual keys to provide for an intuitive user interface.

## Waterproof Protection

The meter is enclosed in an IP67 rated waterproof casing and can withstand immersion in water at a depth of 1 m for up to 30 minutes. The probe features an IP68 rating for continuous immersion in water.



## Quick Connect Digital Probe

The HI7698194 probe features a Quick Connect DIN connector that makes a waterproof connection with the meter.

## Color Coded, Field Replaceable Sensors

Sensor replacement is quick and easy with field replaceable, screw type connectors that are color coded for easy sensor port identification.

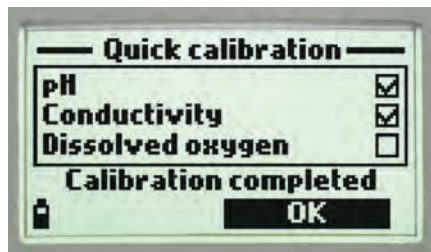

## Standard or Quick Calibration

Quick Calibration provides a speedy, single-point calibration for pH, conductivity, and dissolved oxygen. Standard pH calibration options are available for calibrating up to three points from a selection of five standard buffers and one custom buffer. Conductivity calibration is a single point from six standard selections or one custom standard. Dissolved oxygen calibration is up to two standard points or a single custom point.

## Auto-sensor Recognition

The probe and meter automatically recognize the sensors that are connected. Any ports not used on the probe will not have the parameter displayed or be configurable.

## Automatic Temperature Compensation

Integrated temperature sensor allows for automatic temperature compensation of pH, conductivity, and dissolved oxygen measurements.

## Automatic Barometric Pressure Compensation

The meter features a built-in barometer with user-selectable units for dissolved oxygen pressure compensation.

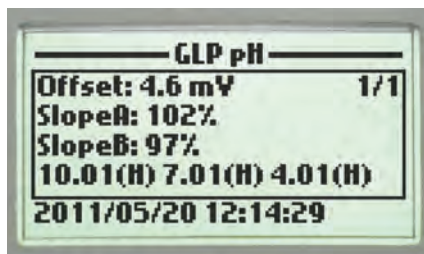

## GLP Data

HI98194 includes a GLP feature that allows users to view calibration data and calibration expiration information at the touch of a key. Calibration data includes date, time, buffers/standards used for calibration, and slope characteristics.

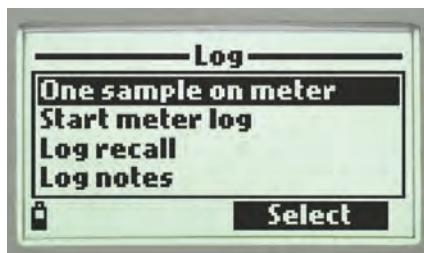

## Data Logging

The HI98194 allows users to store up to 45,000 continuous or log-on-demand samples with logging intervals from one second to three hours.

## Intuitive Keypad

The fitted rubber keypad has dedicated keys for power, backlight, up/down arrows, help and alphanumeric characters. The meter also features two virtual soft keys that navigate the user through the configuration of each parameter, meter setup, and logging of data. The interface is intuitive for any user's level of experience.

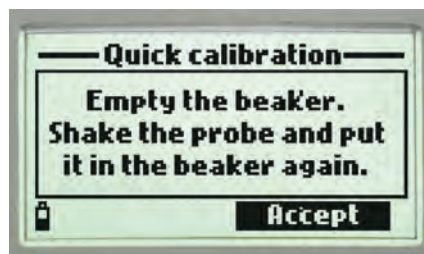

## Dedicated Help Key

Contextual help is always available through a dedicated "HELP" key. Clear tutorial messages and directions are available on-screen to quickly and easily guide users through setup and calibration. The help information displayed is relative to the setting/option being viewed.

## PC Connectivity

Logged data can be transferred to a Window's compatible PC with the included HI920015 micro USB cable and HI9298194 software.

## Long Battery Life

The display of the meter has a battery icon indicator to show the remaining power. The meter uses four 1.5V AA batteries that provide up to 360 hours of battery life.



## Rugged Custom Carrying Case

The HI98194 meter, probe, and all accessories are supplied in a rugged carrying case designed to provide years of use. The inside compartment of the carrying case is thermoformed to securely hold and protect all of the components.

## Probe and Sensors

The HI7698194 is a multiparameter pH/EC/DO/Temperature probe for use with the HI98194 portable meter. It features a Quick Connect DIN that makes a waterproof connection with the meter. Sensors are automatically recognized by the probe and meter when connected. Any ports not used on the probe will not have the parameter displayed on the meter. Sensor replacement is quick and easy with field replaceable, screw type connectors that are color coded for easy sensor identification. The probe features a multistrand-multiconductor shielded cable with 4m, 10m, 20m, and 40m lengths available. It's rugged, waterproof design makes it ideal for field use.

Probe Specifications	HI7698194
Sensor Inputs	three (pH or pH/ORP, DO, EC)
Sample Environment	fresh, brackish, seawater
Waterproof Protection	IP68
Operating Temperature	-5 to 55°C
Storage Temperature	-20 to 70°C
Maximum Depth	20 m (66')
Dimensions (without cable)	342 mm (13.5"); 46 mm (1.8") dia
Weight (without sensors)	570 g (20.1 oz.)
Cable Specification	multistrand-multiconductor shielded cable with internal strength member rated for 68 kg (150 lb.) intermittent use
	Body ABS
	Threads Nylon
Wetted Materials	Shield ABS / 316 SS
	Temperature Probe 316 SS
	O-rings EPDM



HI9828-25  
Quick Calibration  
solution



Sensor Specifications	HI7698194-0	HI7698194-1	HI7698194-3	HI7698194-2
Description	pH sensor	pH/ORP sensor	EC sensor	DO sensor
Measurement Type	pH, mV (pH)	pH, mV (pH), ORP	EC	DO (% saturation and concentration)
Measurement Range	0.00 to 13.00 pH; ±600.0 mV	0.00 to 13.00 pH; ±600.0 mV; ±2000.0 mV	0.0 to 200.0 mS/cm; 0.0 to 400 mS/cm (absolute)	0.0 to 500.0 %; 0.00 to 50.00 mg/L
Temperature Range	-5 to 55°C	-5 to 55°C	-5 to 55°C	-5 to 55°C
Color Code	red	red	blue	white
	Tip glass (pH)	glass (pH); Pt (ORP)	stainless steel electrodes AISI 316	cat/an: Ag/Zn
	Glass Type LT (low temperature)	LT (low temperature)	-	-
Materials	Junction ceramic	ceramic	-	membrane: HDPE
	Body PEI	PEI	ABS/epoxy	white top ABS
	Electrolyte gel	gel	-	-
	Reference double	double	-	-
Maintenance Solution	HI70300 (storage solution)	HI70300 (storage solution)	none	HI7042S (DO electrolyte)
Dimensions	118 x 15 mm	118 x 15 mm	111 x 17 mm	99 x 17 mm
Depth	20 m (65')	20 m (65')	20 m (65')	20 m (65')

HI7698194



## Multi-function Sensor

- Quick sensor replacement
  - Sensor replacement is quick and easy with field replaceable, screw type connectors and are color coded for easy identification. These meters automatically recognize sensors.



- Optional shockproof silicon rubber boot
  - Specially designed to protect your instrument from damage or impact

HI710034 Orange

Specifications		HI98194
pH / mV	Range	0.00 to 14.00 pH / $\pm 600.0$ mV
	Resolution	0.01 pH / 0.1 mV
	Accuracy	$\pm 0.02$ pH / $\pm 0.5$ mV
	Calibration	automatic one, two, or three points with automatic recognition of five standard buffers (pH 4.01, 6.86, 7.01, 9.18, 10.01) or one custom buffer
ORP	Range	$\pm 2000.0$ mV
	Resolution	0.1 mV
	Accuracy	$\pm 1.0$ mV
	Calibration	automatic at one custom point (relative mV)
EC	Range	0 to 200 mS/cm (absolute EC up to 400 mS/cm)
	Resolution	<b>manual:</b> 1 $\mu$ S/cm; 0.001 mS/cm; 0.01 mS/cm; 0.1 mS/cm; 1 mS/cm; <b>automatic:</b> 1 $\mu$ S/cm from 0 to 9999 $\mu$ S/cm; 0.01 mS/cm from 10.00 to 99.99 mS/cm; 0.1 mS/cm from 100.0 to 400.0 mS/cm; <b>automatic mS/cm:</b> 0.001 mS/cm from 0.000 to 9.999 mS/cm; 0.01 mS/cm from 10.00 to 99.99 mS/cm; 0.1 mS/cm from 100.0 to 400.0 mS/cm
	Accuracy	$\pm 1\%$ of reading or $\pm 1$ $\mu$ S/cm whichever is greater
	Calibration	automatic single point, with six standard solutions (84 $\mu$ S/cm, 1413 $\mu$ S/cm, 5.00 mS/cm, 12.88 mS/cm, 80.0 mS/cm, 111.8 mS/cm) or custom point
TDS	Range	0.0 to 400.0 ppt (g/L) (the maximum value depends on the TDS factor)
	Resolution	<b>manual:</b> 1 ppm (mg/L); 0.001 ppt (g/L); 0.01 ppt (g/L); 0.1 ppt (g/L); 1 ppt (g/L); <b>automatic:</b> 1 ppm (mg/L) from 0 to 9999 ppm (mg/L); 0.01 ppt (g/L) from 10.00 to 99.99 ppt (g/L); 0.1 ppt (g/L) from 100.0 to 400.0 ppt (g/L); <b>automatic ppt (g/L):</b> 0.001 ppt (g/L) from 0.000 to 9.999 ppt (g/L); 0.01 ppt (g/L) from 10.00 to 99.99 ppt (g/L); 0.1 ppt (g/L) from 100.0 to 400.0 ppt (g/L)
	Accuracy	$\pm 1\%$ of reading or $\pm 1$ ppm (mg/L) whichever is greater
	Calibration	based on conductivity calibration
Resistivity	Range	0 to 999999 $\Omega \cdot \text{cm}$ ; 0 to 1000.0 $\text{k}\Omega \cdot \text{cm}$ ; 0 to 1.0000 $\text{M}\Omega \cdot \text{cm}$
	Resolution	dependent on resistivity reading
	Calibration	based on conductivity calibration
Salinity	Range	0.00 to 70.00 PSU
	Resolution	0.01 PSU
	Accuracy	$\pm 2\%$ of reading or $\pm 0.01$ PSU whichever is greater
	Calibration	based on conductivity calibration
Seawater $\sigma$	Range	0.0 to 50.0 $\sigma_t, \sigma_\theta, \sigma_{15}$
	Resolution	0.1 $\sigma_t, \sigma_\theta, \sigma_{15}$
	Accuracy	$\pm 1$ $\sigma_t, \sigma_\theta, \sigma_{15}$
	Calibration	based on conductivity calibration
Dissolved Oxygen	Range	0.0 to 500.0%; 0.00 to 50.00 ppm (mg/L)
	Resolution	0.1%; 0.01 ppm (mg/L)
	Accuracy	0.0 to 300.0%: $\pm 1.5\%$ of reading or $\pm 1.0\%$ whichever is greater; 300.0 to 500.0%: $\pm 3\%$ of reading; 0.00 to 30.00 ppm (mg/L): $\pm 1.5\%$ of reading or $\pm 0.10$ ppm (mg/L), whichever is greater; 30.00 ppm (mg/L) to 50.00 ppm (mg/L): $\pm 3\%$ of reading
	Calibration	automatic one or two points at 0, 100% or one custom point
Atmospheric Pressure	Range	450 to 850 mm Hg; 17.72 to 33.46 in Hg; 600.0 to 1133.2 mbar; 8.702 to 16.436 psi; 0.5921 to 1.1184 atm; 60.00 to 113.32 kPa
	Resolution	0.1 mm Hg; 0.01 in Hg; 0.1 mbar; 0.001 psi; 0.0001 atm; 0.01 kPa
	Accuracy	$\pm 3$ mm Hg within $\pm 15^\circ\text{C}$ from the temperature during calibration
	Calibration	automatic at one custom point
Temperature	Range	$-5.00$ to $55.00^\circ\text{C}$ ; $23.00$ to $131.00^\circ\text{F}$ ; 268.15 to 328.15K
	Resolution	0.01 $^\circ\text{C}$ ; 0.01 $^\circ\text{F}$ ; 0.01K
	Accuracy	$\pm 0.15^\circ\text{C}$ ; $\pm 0.27^\circ\text{F}$ ; $\pm 0.15\text{K}$
	Calibration	automatic at one custom point
Additional Specifications	Temperature Compensation	automatic from $-5$ to $55^\circ\text{C}$ ( $23$ to $131^\circ\text{F}$ )
	Logging Memory	45,000 records (continuous logging or log-on-demand of all parameters)
	Logging Interval	one second to three hours
	PC Connectivity	via USB (with Hanna PC software)
	Environment	0 to $50^\circ\text{C}$ ( $32$ to $122^\circ\text{F}$ ); RH 100% IP67
	Battery Type / Life	1.5V AA batteries (4) / approximately 360 hours of continuous use without backlight (50 hours with backlight)
Ordering Information	Dimensions / Weight	185 x 93 x 35.2 mm (7.3 x 3.6 x 1.4") / 400 g (14.2 oz.)
	All models are supplied with: HI7698194-1 pH/ORP sensor, HI7698194-3 EC sensor, HI7698295 short protective probe shield, HI7698194-2 DO sensor, HI9828-20 quick calibration solution, HI76981942 probe maintenance kit, HI7698290 calibration beaker, HI9298194 PC software, HI920015 micro USB cable, batteries (4), quality certificate, and instruction manual in a rugged carrying case with custom insert. <b>HI98194</b> is supplied with HI7698194 multiparameter probe with 4m (13') cable <b>HI98194/10</b> is supplied with HI7698194/10 multiparameter probe with 10m (33') cable <b>HI98194/20</b> is supplied with HI7698194/20 multiparameter probe with 20m (66') cable <b>HI98194/40</b> is supplied with HI7698194/40 multiparameter probe with 40m (131') cable	
Accessories	<b>HI710034</b> orange protective rubber boot	
	<b>HI720194</b> spare thermoformed carrying case for HI98194, HI98195, and HI98196	

HI98195

## Multiparameter Waterproof Meter

pH, ORP, EC, TDS, Resistivity, Salinity, Seawater  $\sigma$  and Temperature

### pH Features

- **Calibration**
  - Up to a three-point calibration with five standard buffers and one custom buffer available
- **pH in mV option**
  - Useful for diagnostics
- **GLP data**
  - Offset, slope, date, time and buffers used
- **Automatically temperature compensated readings**
- **pH or pH/ORP field replaceable sensors**
  - Gel filled and maintenance free
  - Double junction for reduced contamination of reference cell

### EC/TDS/Resistivity Features

- **Calibration**
  - Single-point calibration from six standards
- **Temperature compensation**
  - Automatic Temperature Compensation
  - Configurable temperature coefficient range from 0.00 to 6.00%/°C
  - Choice of reference temperatures at 20 or 25°C
  - Absolute conductivity can be displayed along with the temperature compensated value
- **Auto-ranging**
- **Salinity readings**
  - Practical Salinity Scale (PSU) based on conductivity calibration

The HI98195 is a waterproof portable logging multiparameter meter that monitors up to 9 different water quality parameters. It's multi-sensor probe allows for the measurement of key parameters including pH, ORP, conductivity, and temperature. The probe transmits readings digitally to the meter, where data points can be displayed and logged. The complete system is simple to setup and easy to use.



- **Optional shockproof silicon rubber boot**
  - Specially designed to protect your instrument from damage or impact

HI710034 Orange

## Backlit Graphic LCD Display

The HI98195 features a backlit graphic LCD with on-screen help and the capability to display up to nine parameters simultaneously. The graphic display allows for the use of virtual keys to provide for an intuitive user interface.

## Waterproof Protection

The meter is enclosed in an IP67 rated waterproof casing and can withstand immersion in water at a depth of 1 m for up to 30 minutes. The probe features an IP68 rating for continuous immersion in water.



## Quick Connect Digital Probe

The HI7698195 probe features a Quick Connect DIN connector that makes a waterproof connection with the meter.

## Color Coded, Field Replaceable Sensors

Sensor replacement is quick and easy with field replaceable, screw type connectors that are color coded for easy sensor port identification.

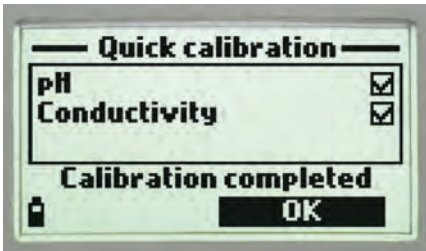

## Standard or Quick Calibration

Quick Calibration provides a speedy, single point calibration for pH and conductivity. Standard pH calibration options are available for calibrating up to three points from a selection of five standard buffers and one custom buffer. Conductivity calibration is a single point from six standard selections or one custom standard.

## Auto-sensor Recognition

The probe and meter automatically recognize the sensors that are connected. Any ports not used on the probe will not have the parameter displayed or be configurable.

## Automatic Temperature Compensation

Integrated temperature sensor allows for automatic temperature compensation of pH and conductivity measurements.

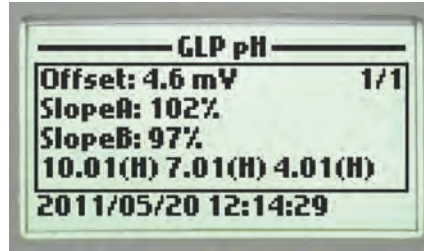

## GLP Data

HI98195 includes a GLP feature that allows users to view calibration data and calibration expiration information at the touch of a key. Calibration data includes date, time, buffers/standards used for calibration, and slope characteristics.

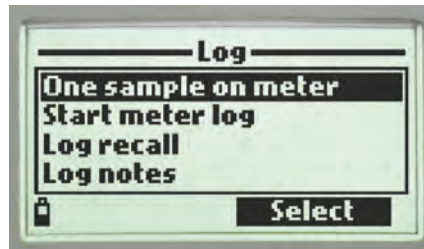

## Data Logging

The HI98195 allows users to store up to 45,000 continuous or log-on-demand samples with logging intervals from one second to three hours.

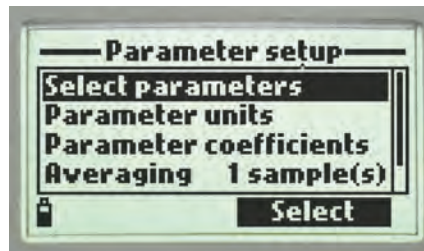

## Intuitive Keypad

The fitted rubber keypad has dedicated keys for power, backlight, up/down arrows, help and alphanumeric characters. The meter also features two virtual soft keys that navigate the user through the configuration of each parameter, meter setup, and logging of data. The interface is intuitive for any user's level of experience.

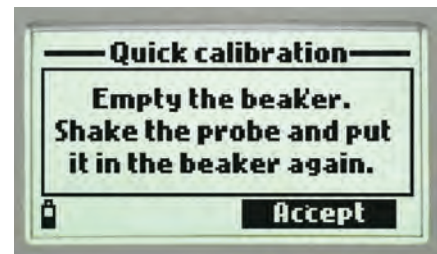

## Dedicated Help Key

Contextual help is always available through a dedicated "HELP" key. Clear tutorial messages and directions are available on-screen to quickly and easily guide users through setup and calibration. The help information displayed is relative to the setting/option being viewed.

## PC Connectivity

Logged data can be transferred to a Window's compatible PC with the included HI920015 micro USB cable and HI9298194 software.

## Long Battery Life

The display of the meter has a battery icon indicator to show the remaining power. The meter uses four 1.5V AA batteries that provide up to 360 hours of battery life.



## Rugged Custom Carrying Case

The HI98195 meter, probe, and all accessories are supplied in a rugged carrying case designed to provide years of use. The inside compartment of the carrying case is thermoformed to securely hold and protect all of the components.

## Probe and Sensors

The HI7698195 is a multiparameter pH/EC/Temperature probe for use with the HI98195 portable meter. It features a Quick Connect DIN that makes a waterproof connection with the meter. Sensors are automatically recognized by the probe and meter when connected. Any ports not used on the probe will not have the parameter displayed on the meter. Sensor replacement is quick and easy with field replaceable, screw type connectors that are color coded for easy sensor identification. The probe features a multistrand-multiconductor shielded cable with 4m, 10m, 20m, and 40m lengths available. It's rugged, waterproof design makes it ideal for field use.

Specifications	HI7698195
Sensor Inputs	two (pH or pH/ORP, EC)
Sample Environment	fresh, brackish, seawater
Waterproof Protection	IP68
Operating Temperature	-5 to 55°C
Storage Temperature	-20 to 70°C
Maximum Depth	20 m (66')
Dimensions (without cable)	342 mm (13.5"); 46 mm (1.8") dia
Weight (without sensors)	570 g (20.1 oz.)
Cable Specification	multistrand-multiconductor shielded cable with internal strength member rated for 68 kg (150 lb.) intermittent use
	Body ABS
	Threads Nylon
Wetted Materials	Shield ABS / 316 SS
	Temperature Probe 316 SS
	O-rings EPDM



HI9828-25  
Quick Calibration  
solution



Sensor Specifications	HI7698194-0	HI7698194-1	HI7698194-3	
Description	pH sensor	pH/ORP sensor	EC sensor	
Measurement Type	pH, mV (pH)	pH, mV (pH), ORP	EC	
Measurement Range	0.00 to 13.00 pH; $\pm 600.0$ mV	0.00 to 13.00 pH; $\pm 600.0$ mV; $\pm 2000.0$ mV	0.0 to 200.0 mS/cm; 0.0 to 400 mS/cm (absolute)	
Temperature Range	-5 to 55°C	-5 to 55°C	-5 to 55°C	
Color Code	red	red	blue	
Materials	Tip	glass (pH)	glass (pH); Pt (ORP)	stainless steel electrodes AISI 316
	Glass Type	LT (low temperature)	LT (low temperature)	-
	Junction	ceramic	ceramic	-
	Body	PEI	PEI	ABS/epoxy
	Electrolyte	gel	gel	-
	Reference	double	double	-
Maintenance Solution	HI70300 (storage solution)	HI70300 (storage solution)	none	
Dimensions	118 x 15 mm	118 x 15 mm	111 x 17 mm	
Depth	20 m (65')	20 m (65')	20 m (65')	



## Multi-function Sensor

- **Quick sensor replacement**
  - Sensor replacement is quick and easy with field replaceable, screw type connectors and are color coded for easy identification. These meters automatically recognize sensors

Specifications	HI98195	
pH / mV	Range	0.00 to 14.00 pH / ±600.0 mV
	Resolution	0.01 pH / 0.1 mV
	Accuracy	±0.02 pH / ±0.5 mV
	Calibration	automatic one, two, or three points with automatic recognition of five standard buffers (pH 4.01, 6.86, 7.01, 9.18, 10.01) or one custom buffer
ORP	Range	±2000.0 mV
	Resolution	0.1 mV
	Accuracy	±1.0 mV
	Calibration	automatic at one custom point (relative mV)
EC	Range	0 to 200 mS/cm (absolute EC up to 400 mS/cm)
	Resolution	<b>manual:</b> 1 µS/cm; 0.001 mS/cm; 0.01 mS/cm; 0.1 mS/cm; 1 mS/cm; <b>automatic:</b> 1 µS/cm from 0 to 9999 µS/cm; 0.01 mS/cm from 10.00 to 99.99 mS/cm; 0.1 mS/cm from 100.0 to 400.0 mS/cm; <b>automatic mS/cm:</b> 0.001 mS/cm from 0.000 to 9.999 mS/cm; 0.01 mS/cm from 10.00 to 99.99 mS/cm; 0.1 mS/cm from 100.0 to 400.0 mS/cm
	Accuracy	±1% of reading or ±1 µS/cm whichever is greater
	Calibration	automatic single point, with six standard solutions (84 µS/cm, 1413 µS/cm, 5.00 mS/cm, 12.88 mS/cm, 80.0 mS/cm, 111.8 mS/cm) or custom point
TDS	Range	0.0 to 400.0 ppt (g/L) (the maximum value depends on the TDS factor)
	Resolution	<b>manual:</b> 1 ppm (mg/L); 0.001 ppt (g/L); 0.01 ppt (g/L); 0.1 ppt (g/L); 1 ppt (g/L); <b>automatic:</b> 1 ppm (mg/L) from 0 to 9999 ppm (mg/L); 0.01 ppt (g/L) from 10.00 to 99.99 ppt (g/L); 0.1 ppt (g/L) from 100.0 to 400.0 ppt (g/L); <b>automatic ppt (g/L):</b> 0.001 ppt (g/L) from 0.000 to 9.999 ppt (g/L); 0.01 ppt (g/L) from 10.00 to 99.99 ppt (g/L); 0.1 ppt (g/L) from 100.0 to 400.0 ppt (g/L)
	Accuracy	±1% of reading or ±1 ppm (mg/L) whichever is greater
	Calibration	based on conductivity or salinity calibration
Resistivity	Range	0 to 999999 Ω•cm; 0 to 1000.0 kΩ•cm; 0 to 1.0000 MΩ•cm
	Resolution	dependent on resistivity reading
	Calibration	based on conductivity or salinity calibration
Salinity	Range	0.00 to 70.00 PSU
	Resolution	0.01 PSU
	Accuracy	±2% of reading or ±0.01 PSU whichever is greater
	Calibration	based on conductivity calibration
Seawater σ	Range	0.0 to 50.0 σ <sub>t</sub> , σ <sub>0</sub> , σ <sub>15</sub>
	Resolution	0.1 σ <sub>t</sub> , σ <sub>0</sub> , σ <sub>15</sub>
	Accuracy	±1 σ <sub>t</sub> , σ <sub>0</sub> , σ <sub>15</sub>
	Calibration	based on conductivity or salinity calibration
Temperature	Range	-5.00 to 55.00°C; 23.00 to 131.00°F; 268.15 to 328.15K
	Resolution	0.01°C; 0.01°F; 0.01K
	Accuracy	±0.15°C; ±0.27°F; ±0.15K
	Calibration	automatic at one custom point
Additional Specifications	Temperature Compensation	automatic from -5 to 55°C (23 to 131°F)
	Logging Memory	45,000 records (continuous logging or log-on-demand of all parameters)
	Logging Interval	one second to three hours
	PC Connectivity	via USB (with Hanna PC software)
	Environment	0 to 50°C (32 to 122°F); RH 100% IP67
	Battery Type / Life	1.5V AA batteries (4) / approximately 360 hours of continuous use without backlight (50 hours with backlight)
Dimensions / Weight	185 x 93 x 35.2 mm (7.3 x 3.6 x 1.4") / 400 g (14.2 oz.)	
Ordering Information	<p>All models are supplied with:            HI7698194-1 pH/ORP sensor, HI7698194-3 EC sensor, HI7698295 short protective probe shield, HI9828-20 quick calibration solution, HI76981952 probe maintenance kit, HI7698290 calibration beaker, HI9298194 PC software, HI920015 micro USB cable, batteries (4), quality certificate, and instruction manual in a rugged carrying case with custom insert.</p> <p><b>HI98195</b> is supplied with HI7698195 multiparameter probe with 4m (13') cable  <b>HI98195/10</b> is supplied with HI7698195/10 multiparameter probe with 10m (33') cable  <b>HI98195/20</b> is supplied with HI7698195/20 multiparameter probe with 20m (66') cable  <b>HI98195/40</b> is supplied with HI7698195/40 multiparameter probe with 40m (131') cable</p>	
Accessories	<p><b>HI710034</b> orange protective rubber boot</p> <p><b>HI720194</b> spare thermoformed carrying case for HI98194, HI98195, and HI98196</p>	

HI981954

## Multiparameter Waterproof Meter

pH, ORP, EC, TDS, Resistivity, Salinity,  
Seawater  $\sigma$  and Temperature

### pH Features

- **Calibration**
  - Up to a three-point calibration with five standard buffers and one custom buffer available
- **pH in mV option**
  - Useful for diagnostics
- **GLP data**
  - Offset, slope, date, time and buffers used
- **Automatically temperature compensated readings**
- **pH or pH/ORP field replaceable sensors**
  - Gel filled and maintenance free
  - Double junction for reduced contamination of reference cell

### EC/TDS/Resistivity Features

- **Calibration**
  - Single-point calibration from six standards
- **Temperature compensation**
  - Automatic Temperature Compensation
  - Configurable temperature coefficient range from 0.00 to 6.00%/°C
  - Choice of reference temperatures at 20 or 25°C
  - Absolute conductivity can be displayed along with the temperature compensated value
- **Auto-ranging**
- **Salinity readings**
  - Practical Salinity Scale (PSU) based on conductivity calibration

The HI981954 is a waterproof portable logging multiparameter meter that monitors up to 9 different water quality parameters. Its multi-sensor probe allows for the measurement of key parameters including pH, ORP, conductivity, and temperature. The probe transmits readings digitally to the meter, where data points can be displayed and logged. The complete system is simple to setup and easy to use.



- **Optional shockproof silicon rubber boot**
  - Specially designed to protect your instrument from damage or impact

HI710034 Orange





## Backlit Graphic LCD Display

The HI981954 features a backlit graphic LCD with on-screen help and the capability to display up to nine parameters simultaneously. The graphic display allows for the use of virtual keys to provide for an intuitive user interface.

## Waterproof Protection

The meter is enclosed in an IP67 rated waterproof casing and can withstand immersion in water at a depth of 1 m for up to 30 minutes. The probe features an IP68 rating for continuous immersion in water.



## Quick Connect Digital Probe

The HI7698195 probe features a Quick Connect DIN connector that makes a waterproof connection with the meter.

## Color Coded, Field Replaceable Sensors

Sensor replacement is quick and easy with field replaceable, screw type connectors that are color coded for easy sensor port identification.

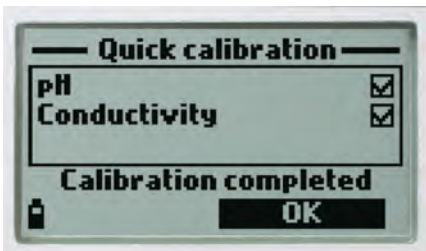

## Standard or Quick Calibration

Quick Calibration provides a speedy, single point calibration for pH and conductivity. Standard pH calibration options are available for calibrating up to three points from a selection of five standard buffers and one custom buffer. Conductivity calibration is a single point from six standard selections or one custom standard.

## Auto-sensor Recognition

The probe and meter automatically recognize the sensors that are connected. Any ports not used on the probe will not have the parameter displayed or be configurable.

## Automatic Temperature Compensation

Integrated temperature sensor allows for automatic temperature compensation of pH and conductivity measurements.



## GLP Data

HI981954 includes a GLP feature that allows users to view calibration data and calibration expiration information at the touch of a key. Calibration data includes date, time, buffers/standards used for calibration, and slope characteristics.

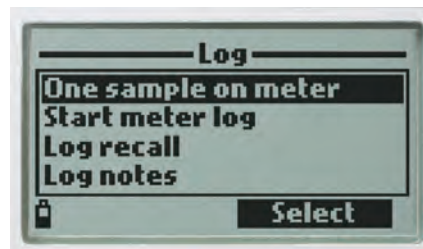

## Data Logging

The HI981954 allows users to store up to 45,000 continuous or log-on-demand samples with logging intervals from one second to three hours.



## Intuitive Keypad

The fitted rubber keypad has dedicated keys for power, backlight, up/down arrows, help and alphanumeric characters. The meter also features two virtual soft keys that navigate the user through the configuration of each parameter, meter setup, and logging of data. The interface is intuitive for any user's level of experience.

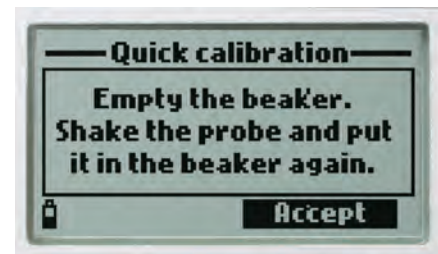

## Dedicated Help Key

Contextual help is always available through a dedicated "HELP" key. Clear tutorial messages and directions are available on-screen to quickly and easily guide users through setup and calibration. The help information displayed is relative to the setting/option being viewed.

## PC Connectivity

Logged data can be transferred to a Window's compatible PC with the included HI920015 micro USB cable and HI9298194 software.

## Long Battery Life

The display of the meter has a battery icon indicator to show the remaining power. The meter uses four 1.5V AA batteries that provide up to 360 hours of battery life.



## Rugged Custom Carrying Case

The HI981954 meter, probe, and all accessories are supplied in a rugged carrying case designed to provide years of use. The inside compartment of the carrying case is thermoformed to securely hold and protect all of the components.

## Probe and Sensors

The HI7698195 is a multiparameter pH/EC/Temperature probe for use with the HI981954 portable meter. It features a Quick Connect DIN that makes a waterproof connection with the meter. Sensors are automatically recognized by the probe and meter when connected. Any ports not used on the probe will not have the parameter displayed on the meter. Sensor replacement is quick and easy with field replaceable, screw type connectors that are color coded for easy sensor identification. The probe features a multistrand-multiconductor shielded cable with 4m, 10m, 20m, and 40m lengths available. It's rugged, waterproof design makes it ideal for field use.

Specifications	HI7698195	
Sensor Inputs	two (pH or pH/ORP, EC)	
Sample Environment	fresh, brackish, seawater	
Waterproof Protection	IP68	
Operating Temperature	-5 to 55°C	
Storage Temperature	-20 to 70°C	
Maximum Depth	20 m (66')	
Dimensions (without cable)	342 mm (13.5"); 46 mm (1.8") dia	
Weight (without sensors)	570 g (20.1 oz.)	
Cable Specification	multistrand-multiconductor shielded cable with internal strength member rated for 68 kg (150 lb.) intermittent use	
Wetted Materials	Body	ABS
	Threads	Nylon
	Shield	ABS / 316 SS
	Temperature Probe	316 SS
	O-rings	EPDM



HI9828-25  
Quick Calibration  
solution



Sensor Specifications	HI7698194-0	HI7698194-1	HI7698194-3	
Description	pH sensor	pH/ORP sensor	EC sensor	
Measurement Type	pH, mV (pH)	pH, mV (pH), ORP	EC	
Measurement Range	0.00 to 13.00 pH; $\pm 600.0$ mV	0.00 to 13.00 pH; $\pm 600.0$ mV; $\pm 2000.0$ mV	0.0 to 200.0 mS/cm; 0.0 to 400 mS/cm (absolute)	
Temperature Range	-5 to 55°C	-5 to 55°C	-5 to 55°C	
Color Code	red	red	blue	
Materials	Tip	glass (pH)	glass (pH); Pt (ORP)	stainless steel electrodes AISI 316
	Glass Type	LT (low temperature)	LT (low temperature)	-
	Junction	ceramic	ceramic	-
	Body	PEI	PEI	ABS/epoxy
	Electrolyte	gel	gel	-
	Reference	double	double	-
Maintenance Solution	HI70300 (storage solution)	HI70300 (storage solution)	none	
Dimensions	118 x 15 mm	118 x 15 mm	111 x 17 mm	
Depth	20 m (65')	20 m (65')	20 m (65')	



## Multi-function Sensor

- **Quick sensor replacement**
  - Sensor replacement is quick and easy with field replaceable, screw type connectors and are color coded for easy identification. These meters automatically recognize sensors

Specifications	HI981954	
pH / mV	Range	0.00 to 14.00 pH / $\pm 600.0$ mV
	Resolution	0.01 pH / 0.1 mV
	Accuracy	$\pm 0.02$ pH / $\pm 0.5$ mV
	Calibration	automatic one, two, or three points with automatic recognition of five standard buffers (pH 4.01, 6.86, 7.01, 9.18, 10.01) or one custom buffer
ORP	Range	$\pm 2000.0$ mV
	Resolution	0.1 mV
	Accuracy	$\pm 1.0$ mV
	Calibration	automatic at one custom point (relative mV)
EC	Range	0 to 200 mS/cm (absolute EC up to 400 mS/cm)
	Resolution	<b>manual:</b> 1 $\mu$ S/cm; 0.001 mS/cm; 0.01 mS/cm; 0.1 mS/cm; 1 mS/cm; <b>automatic:</b> 1 $\mu$ S/cm from 0 to 9999 $\mu$ S/cm; 0.01 mS/cm from 10.00 to 99.99 mS/cm; 0.1 mS/cm from 100.0 to 400.0 mS/cm; <b>automatic mS/cm:</b> 0.001 mS/cm from 0.000 to 9.999 mS/cm; 0.01 mS/cm from 10.00 to 99.99 mS/cm; 0.1 mS/cm from 100.0 to 400.0 mS/cm
	Accuracy	$\pm 1\%$ of reading or $\pm 1$ $\mu$ S/cm whichever is greater
	Calibration	automatic single point, with six standard solutions (84 $\mu$ S/cm, 1413 $\mu$ S/cm, 5.00 mS/cm, 12.88 mS/cm, 80.0 mS/cm, 111.8 mS/cm) or custom point
TDS	Range	0.0 to 400.0 ppt (g/L) (the maximum value depends on the TDS factor)
	Resolution	<b>manual:</b> 1 ppm (mg/L); 0.001 ppt (g/L); 0.01 ppt (g/L); 0.1 ppt (g/L); 1 ppt (g/L); <b>automatic:</b> 1 ppm (mg/L) from 0 to 9999 ppm (mg/L); 0.01 ppt (g/L) from 10.00 to 99.99 ppt (g/L); 0.1 ppt (g/L) from 100.0 to 400.0 ppt (g/L); <b>automatic ppt (g/L):</b> 0.001 ppt (g/L) from 0.000 to 9.999 ppt (g/L); 0.01 ppt (g/L) from 10.00 to 99.99 ppt (g/L); 0.1 ppt (g/L) from 100.0 to 400.0 ppt (g/L)
	Accuracy	$\pm 1\%$ of reading or $\pm 1$ ppm (mg/L) whichever is greater
	Calibration	based on conductivity or salinity calibration
Resistivity	Range	0 to 999999 $\Omega \cdot \text{cm}$ ; 0 to 1000.0 $\text{k}\Omega \cdot \text{cm}$ ; 0 to 1.0000 $\text{M}\Omega \cdot \text{cm}$
	Resolution	dependent on resistivity reading
	Calibration	based on conductivity or salinity calibration
Salinity	Range	0.00 to 70.00 PSU
	Resolution	0.01 PSU
	Accuracy	$\pm 2\%$ of reading or $\pm 0.01$ PSU whichever is greater
	Calibration	based on conductivity calibration
Seawater $\sigma$	Range	0.0 to 50.0 $\sigma_t$ , $\sigma_\theta$ , $\sigma_{15}$
	Resolution	0.1 $\sigma_t$ , $\sigma_\theta$ , $\sigma_{15}$
	Accuracy	$\pm 1$ $\sigma_t$ , $\sigma_\theta$ , $\sigma_{15}$
	Calibration	based on conductivity or salinity calibration
Temperature	Range	-5.00 to 55.00°C; 23.00 to 131.00°F; 268.15 to 328.15K
	Resolution	0.01°C; 0.01°F; 0.01K
	Accuracy	$\pm 0.15$ °C; $\pm 0.27$ °F; $\pm 0.15$ K
	Calibration	automatic at one custom point
Additional Specifications	Temperature Compensation	automatic from -5 to 55°C (23 to 131°F)
	Logging Memory	45,000 records (continuous logging or log-on-demand of all parameters)
	Logging Interval	one second to three hours
	PC Connectivity	via USB (with Hanna PC software)
	Environment	0 to 50°C (32 to 122°F); RH 100% IP67
	Battery Type / Life	1.5V AA batteries (4) / approximately 360 hours of continuous use without backlight (50 hours with backlight)
Dimensions / Weight	185 x 93 x 35.2 mm (7.3 x 3.6 x 1.4") / 400 g (14.2 oz.)	
Ordering Information	<b>HI981954</b> is supplied with HI7698195 multiparameter probe with 4m (13') cable, HI7698194-1 pH/ORP sensor, HI7698194-3 EC sensor, HI7698295 short protective probe shield, HI9828-20 quick calibration solution, HI76981952 probe maintenance kit, HI7698290 calibration beaker, HI9298194 PC software, HI920015 micro USB cable, batteries (4), quality certificate, and instruction manual in a rugged carrying case with custom insert.	
Accessories	<b>HI710034</b> orange protective rubber boot	

HI98196

# Multiparameter Waterproof Meter

pH, ORP, Dissolved Oxygen,  
Atmospheric Pressure and  
Temperature

## pH Features

- **Calibration**
  - Up to a three-point calibration with five standard buffers and one custom buffer available
- **pH in mV option**
  - Useful for diagnostics
- **GLP data**
  - Offset, slope, date, time and buffers used
- **Automatically temperature compensated readings**
- **pH or pH/ORP field replaceable sensors**
  - Gel filled and maintenance free
  - Double junction for reduced contamination of reference cell

## Dissolved Oxygen Features

- **Choice of units**
  - Display units in % saturation or ppm (mg/L)
- **Salinity compensation for saline waters**
  - Manual entry of salinity values
  - Readings compensated for salinity effects
- **Built-in barometer**
  - Automatic compensation for changes in atmospheric pressure
  - User selectable units
- **Temperature compensation**
- **Polarization**
  - Automatic polarization of probe at startup
- **Membrane caps**
  - Ready-to-use HDPE pre-tensioned membrane caps are easy to replace

The HI98196 is a waterproof portable logging multiparameter meter that monitors up to 6 different water quality parameters. It's multi-sensor probe allows for the measurement of key parameters including pH, ORP, conductivity, dissolved oxygen, and temperature. The probe transmits readings digitally to the meter, where data points can be displayed and logged. The complete system is simple to setup and easy to use.



- **Optional shockproof silicon rubber boot**
  - Specially designed to protect your instrument from damage or impact

HI710034 Orange

## Backlit Graphic LCD Display

The HI98196 features a backlit graphic LCD with on-screen help and the capability to display up to twelve parameters simultaneously. The graphic display allows for the use of virtual keys to provide for an intuitive user interface.

## Waterproof Protection

The meter is enclosed in an IP67 rated waterproof casing and can withstand immersion in water at a depth of 1 m for up to 30 minutes. The probe features an IP68 rating for continuous immersion in water.



## Quick Connect Digital Probe

The HI7698196 probe features a Quick Connect DIN connector that makes a waterproof connection with the meter.

## Color Coded, Field Replaceable Sensors

Sensor replacement is quick and easy with field replaceable, screw type connectors that are color coded for easy sensor port identification.

## Standard Calibration

Standard pH calibration options are available for calibrating up to three points from a selection of five standard buffers and one custom buffer. Dissolved oxygen calibration is up to two standard points or a single custom point.

## Auto-sensor Recognition

The probe and meter automatically recognize the sensors that are connected. Any ports not used on the probe will not have the parameter displayed or be configurable.

## Automatic Temperature Compensation

Integrated temperature sensor allows for automatic temperature compensation of pH and dissolved oxygen measurements.

## Automatic Barometric Pressure Compensation

The meter features a built-in barometer with user-selectable units for dissolved oxygen pressure compensation.

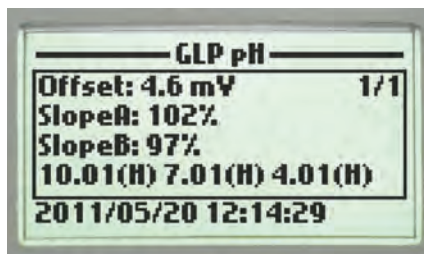

## GLP Data

HI98196 includes a GLP feature that allows users to view calibration data and calibration expiration information at the touch of a key. Calibration data includes date, time, buffers/standards used for calibration, and slope characteristics.

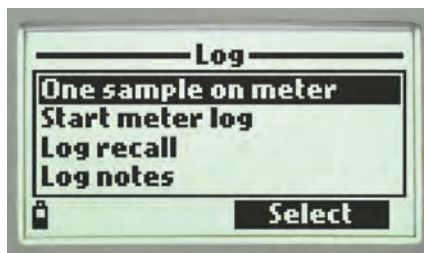

## Data Logging

The HI98196 allows users to store up to 45,000 continuous or log-on-demand samples with logging intervals from one second to three hours.

## Intuitive Keypad

The fitted rubber keypad has dedicated keys for power, backlight, up/down arrows, help and alphanumeric characters. The meter also features two virtual soft keys that navigate the user through the configuration of each parameter, meter setup, and logging of data. The interface is intuitive for any user's level of experience.

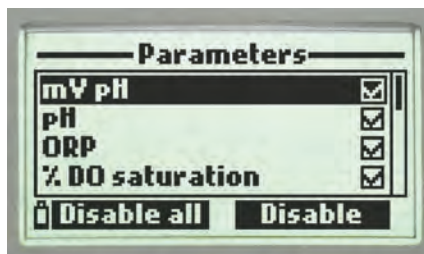

## Setup

Extensive setup screen features

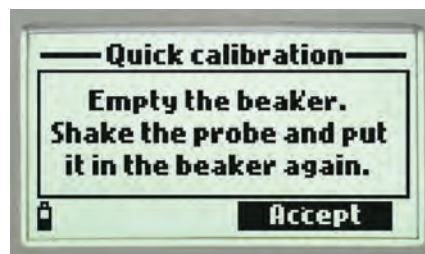

## Dedicated Help Key

Contextual help is always available through a dedicated "HELP" key. Clear tutorial messages and directions are available on-screen to quickly and easily guide users through setup and calibration. The help information displayed is relative to the setting/option being viewed.

## PC Connectivity

Logged data can be transferred to a Window's compatible PC with the included HI920015 micro USB cable and HI9298194 software.

## Long Battery Life

The display of the meter has a battery icon indicator to show the remaining power. The meter uses four 1.5V AA batteries that provide up to 360 hours of battery life.



## Rugged custom carrying case

The HI98196 meter, probe, and all accessories are supplied in a rugged carrying case designed to provide years of use. The inside compartment of the carrying case is thermoformed to securely hold and protect all of the components.

## Probe and Sensors

The HI7698196 is a multiparameter pH/DO/Temperature probe for use with the HI98196 portable meter. It features a Quick Connect DIN that makes a waterproof connection with the meter. Sensors are automatically recognized by the probe and meter when connected. Any ports not used on the probe will not have the parameter displayed on the meter. Sensor replacement is quick and easy with field replaceable, screw type connectors that are color coded for easy sensor identification. The probe features a multistrand-multiconductor shielded cable with 4m, 10m, 20m, and 40m lengths available. It's rugged, waterproof design makes it ideal for field use.



Specifications	HI7698196
Sensor Inputs	two (pH or pH/ORP, DO)
Sample Environment	fresh, brackish, seawater
Waterproof Protection	IP68
Operating Temperature	-5 to 55°C
Storage Temperature	-20 to 70°C
Maximum Depth	20 m (66')
Dimensions (without cable)	342 mm (13.5"); 46 mm (1.8") dia
Weight (without sensors)	570 g (20.1 oz.)
Cable Specification	multistrand-multiconductor shielded cable with internal strength member rated for 68 kg (150 lb.) intermittent use
	Body ABS
	Threads Nylon
Wetted Materials	Shield ABS / 316 SS
	Temperature Probe 316 SS
	O-rings EPDM

## Multi-function Sensor

- Quick sensor replacement
  - Sensor replacement is quick and easy with field replaceable, screw type connectors and are color coded for easy identification. These meters automatically recognize sensors



Sensor Specifications	HI7698194-0	HI7698194-1	HI7698194-2
Description	pH sensor	pH/ORP sensor	DO sensor
Measurement Type	pH, mV (pH)	pH, mV (pH), ORP	DO (% saturation and concentration)
Measurement Range	0.00 to 13.00 pH; ±600.0 mV	0.00 to 13.00 pH; ±600.0 mV; ±2000.0 mV	0.0 to 500.0 %; 0.00 to 50.00 mg/L
Temperature Range	-5 to 55°C	-5 to 55°C	-5 to 55°C
Color Code	red	red	white
	Tip glass (pH)	glass (pH); Pt (ORP)	cat/an: Ag/Zn
	Glass Type LT (low temperature)	LT (low temperature)	-
Materials	Junction ceramic	ceramic	membrane: HDPE
	Body PEI	PEI	white top ABS
	Electrolyte gel	gel	-
	Reference double	double	-
Maintenance Solution	HI70300 (storage solution)	HI70300 (storage solution)	HI7042S (DO electrolyte)
Dimensions	118 x 15 mm	118 x 15 mm	99 x 17 mm
Depth	20 m (65')	20 m (65')	20 m (65')



Specifications	HI98196	
pH / mV	Range	0.00 to 14.00 pH / $\pm 600.0$ mV
	Resolution	0.01 pH / 0.1 mV
	Accuracy	$\pm 0.02$ pH / $\pm 0.5$ mV
	Calibration	automatic up to three points with automatic recognition of five standard buffers (pH 4.01, 6.86, 7.01, 9.18, 10.01) or one custom buffer
ORP	Range	$\pm 2000.0$ mV
	Resolution	0.1 mV
	Accuracy	$\pm 1.0$ mV
	Calibration	automatic at one custom point (relative mV)
Dissolved Oxygen	Range	0.0 to 500.0%; 0.00 to 50.00 ppm (mg/L)
	Resolution	0.1%; 0.01 ppm (mg/L)
	Accuracy	0.0 to 300.0%; $\pm 1.5\%$ of reading or $\pm 1.0\%$ whichever is greater; 300.0 to 500.0%; $\pm 3\%$ of reading; 0.00 to 30.00 ppm (mg/L); $\pm 1.5\%$ of reading or $\pm 0.10$ ppm (mg/L), whichever is greater; 30.00 ppm (mg/L) to 50.00 ppm (mg/L); $\pm 3\%$ of reading
	Calibration	automatic one or two points at 0, 100% or one custom point
Atmospheric Pressure	Range	450 to 850 mm Hg; 17.72 to 33.46 in Hg; 600.0 to 1133.2 mbar; 8.702 to 16.436 psi; 0.5921 to 1.1184 atm; 60.00 to 113.32 kPa
	Resolution	0.1 mm Hg; 0.01 in Hg; 0.1 mbar; 0.001 psi; 0.0001 atm; 0.01 kPa
	Accuracy	$\pm 3$ mm Hg within $\pm 15^\circ\text{C}$ from the temperature during calibration
	Calibration	automatic at one custom point
Temperature	Range	$-5.00$ to $55.00^\circ\text{C}$ ; $23.00$ to $131.00^\circ\text{F}$ ; 268.15 to 328.15K
	Resolution	$0.01^\circ\text{C}$ ; $0.01^\circ\text{F}$ ; 0.01K
	Accuracy	$\pm 0.15^\circ\text{C}$ ; $\pm 0.27^\circ\text{F}$ ; $\pm 0.15\text{K}$
	Calibration	automatic at one custom point
Additional Specifications	Temperature Compensation	automatic from $-5$ to $55^\circ\text{C}$ (23 to $131^\circ\text{F}$ )
	Logging Memory	45,000 records (continuous logging or log-on-demand of all parameters)
	Logging Interval	one second to three hours
	PC Connectivity	via USB (with Hanna PC software)
	Environment	0 to $50^\circ\text{C}$ (32 to $122^\circ\text{F}$ ); RH 100% IP67
	Battery Type / Life	1.5V AA batteries (4) / approximately 360 hours of continuous use without backlight (50 hours with backlight)
Dimensions / Weight	185 x 93 x 35.2 mm (7.3 x 3.6 x 1.4") / 400 g (14.2 oz.)	
	All models are supplied with: HI7698194-1 pH/ORP sensor, HI7698194-2 DO sensor, HI7698295 short protective probe shield, HI9828-20 quick calibration solution, HI76981942 probe maintenance kit, HI7698290 calibration beaker, HI9298194 PC software, HI920015 micro USB cable, batteries (4), quality certificate, and instruction manual in a rugged carrying case with custom insert. <b>HI98196</b> is supplied with HI7698196 multiparameter probe with 4m (13') cable <b>HI98196/10</b> is supplied with HI7698196/10 multiparameter probe with 10m (33') cable <b>HI98196/20</b> is supplied with HI7698196/20 multiparameter probe with 20m (66') cable <b>HI98196/40</b> is supplied with HI7698196/40 multiparameter probe with 40m (131') cable	
Accessories	<b>HI710034</b> orange protective rubber boot	
	<b>HI720194</b> spare thermoformed carrying case for HI98194, HI98195, and HI98196	

HI991300 · HI991301

## pH/EC/TDS/ Temperature Meters

- Simultaneous, pH, EC/TDS and temperature measurements on a large three-line LCD display;
- User-friendly Design
  - With only two buttons, meter operation could not be simpler. Two buttons allow you to quickly adjust settings, select the measurement range, and choose calibration buffer sets.



- **Watertight Connection**
  - A Quick Connect DIN connector makes attaching and removing the probe simple and easy. The rubber coating protects the cable and creates a sealed connection for added reliability.
- **Probe Condition**
  - An on-screen indicator provides visual confirmation that your probe is working at its best.
- **Large LCD**
  - A multilevel display provides at-a-glance readings of your most important numbers from any angle.
- **Durable IP67 waterproof casing**
  - Designed to withstand the knocks, drops, and spills of real life, the new IP67 body ensures top performance in any environment. These meters are totally protected against dust and water intrusion from any direction.
- **On-screen calibration tags**
- **mV of pH measurement for electrode check**
- **Selectable temperature unit (°C or °F)**
- **Battery life indication and low battery detection**



- **Optional shockproof silicon rubber boot**
  - Specially designed to protect your instrument from damage or impact

**HI710028** Orange  
**HI710029** Blue

The HI991300 and HI991301 are light weight, portable pH, conductivity (or total dissolved solids) and temperature meters for portable applications requiring both a pH and conductivity (or TDS) measurement. Applications include measurements for greenhouses irrigation, hydroponics and groundwater monitoring from agriculture nutrient pollution.

The HI991300 and HI991301 meters feature 2 button operation and are simple to use. All operations and settings, including calibration buffers and temperature scale selections, are made through these 2 buttons. They have a waterproof and compact casing rated for IP67 conditions and a large Tri-line display. The meters have automatic pH calibration at one or two points and a single conductivity calibration. Other user selectable features include different TDS factors from 0.45 to 1.00, and a range of temperature coefficients ( $\beta$ ) from 0.0 to 2.4% for better conductivity or TDS solution temperature compensation. These meters are supplied with a multi-parameter probe specifically designed for these meters. To increase conductivity accuracy, two meter models are available, with different conductivity ranges, for applications from purified to brackish waters.

The HI12883 multi-parameter probe, incorporates a domed shaped pH bulb rated from 0-13 pH, a single junction Ag/AgCl reference electrode with gelled electrolyte and a retractable cloth wick junction, a graphite EC/TDS cell, and a temperature sensor in one convenient, rugged polypropylene body. In addition, to ensure against interference from transient electrical noise to pH, a solidstate preamplifier is integrated into the probe. The probe is rated from 0 to 50°C.



## HI1288 amplified pH electrode

- 3 sensors in a single probe
- Pre-amplified pH electrode for resistance to electrical noise
- Extractable cloth junction to clear any clogging
- Graphite EC/TDS sensor

The HI991301 and HI991300 are supplied with an amplified polypropylene body pH/EC/TDS/temperature probe. The built in amplifier will reduce the effects of electrical noise on the high impedance pH measurement. Examples of sources of electrical noise include rectifiers, motors and ballasts.

The HI1288 pH electrode also features an extractable cloth junction. Every pH electrode has a junction. Many use a single ceramic frit

which acts as a barrier between the inside reference cell to the outside sample. This barrier allows for a diffusion electrolyte that is necessary for the pH measurement. Any clogging of the junction will result in a reduced diffusion and as a result the readings will become erratic. Most probes will have to have this junction cleaned and if not possible then the probe has to be replaced. The extractable cloth junction of the HI1288 allows for the renewing of the junction. Simply extract  $\frac{1}{8}$ " of the junction by pulling on the junction will expose a new portion. Any clogging that was present will be cleared and the response time will be back to normal extending the life of the pH electrode.

The EC/TDS sensor is made of graphite. A common problem with amperometric sensors is a polarization effect. With amperometric sensors there are two poles in which a voltage is alternated. The positive and negative ions



in the solution migrate to one of the negative or positive poles. When the charges build up on one of these poles a polarization effect occurs. Having a conductivity sensor made of graphite reduces the polarization effect.

Specifications	HI991300	HI991301	
pH	Range*	-2.00 to 16.00 pH / -2.0 to 16.0 pH	-2.00 to 16.00 pH / -2.0 to 16.0 pH
	Resolution	0.01 pH / 0.1 pH	0.01 pH / 0.1 pH
	Accuracy (@25°C/77°F)	±0.02 pH / ±0.1 pH	±0.02 pH / ±0.1 pH
	Calibration	automatic, 1 or 2 points choose between 2 sets of buffers (standard: 4.01; 7.01; 10.01 or NIST: 4.01; 6.86; 9.18)	automatic, 1 or 2 points choose between 2 sets of buffers (standard: 4.01; 7.01; 10.01 or NIST: 4.01; 6.86; 9.18)
pH-mV	Range	±825 mV	±825 mV
	Resolution	1 mV	1 mV
	Accuracy (@25°C/77°F)	±1 mV	±1 mV
EC	Range	0 to 3999 µS/cm**	0.00 to 20.00 mS/cm**
	Resolution	1 µS/cm	0.01 mS/cm
	Accuracy (@25°C/77°F)	±2% F.S.	±2% F.S.
TDS	Range	0 to 2000 ppm (mg/L)	0.00 to 10.00 ppt (g/L)
	Resolution	1 ppm (mg/L)	0.01 ppt (g/L)
	Accuracy (@25°C/77°F)	±2% F.S.	±2% F.S.
Temperature	Range*	-5.0 to 105.0°C / 23.0 to 221.0°F	-5.0 to 105.0°C / 23.0 to 221.0°F
	Resolution	0.1°C/0.1°F	0.1°C/0.1°F
	Accuracy (@25°C/77°F)	±0.5°C / ±1.0°F	±0.5°C / ±1.0°F
Ordering Information	EC/TDS Calibration	automatic, one point at: 1413 µS/cm or 1382 ppm (CONV=0.5) or 1500 ppm (CONV=0.7)	automatic, one point at: 12880 µS/cm or 6.44 ppt (CONV=0.5) or 9.02 ppt (CONV=0.7)
	pH Temp. Compensation	automatic	automatic
	EC/TDS Temperature Compensation	automatic with β selectable from 0.0-2.4%/°C with 0.1 increments	
	TDS Conversion Factor	selectable from 0.45 to 1.00 with 0.01 increments	
	Probe (included)	HI12883 pH/EC/TDS/temperature sensor, DIN connector and 1 m (3.3') cable	
	Battery Type/Life	1.5V AAA (3) /approx. 600 hours of continuous use	
	Auto-off	user selectable: after 8 min, 60 min or disabled	
	Environment	0 to 50°C (32 to 122°F); RH max. 100%	
	Meter Dimensions	154 x 63 x 30 mm (6.1 x 2.5 x 1.2")	
	Meter Mass (with batteries)	196 g (6.91 oz.)	
	Casing Ingress Protection Rating	IP67	
		<p><b>HI991300</b> is supplied with HI12883 pH/EC/TDS probe with built-in temperature sensor, DIN connector and 1m (3.3') cable, pH 4.01 and 7.01 buffer sachets, HI70031 1413 µS/cm and HI70032 1382 ppm calibration solution sachets, HI700601 Electrode cleaning solution sachets (2), 100 mL beaker, 1.5V AAA batteries (3), calibration certificate of meter, calibration certificate of probe, instruction manual and HI710142 rugged carrying case.</p> <p><b>HI991301</b> is supplied with HI12883 pH/EC/TDS probe with built-in temperature sensor, DIN connector and 1m (3.3') cable, pH 4.01 and 7.01 buffer sachets, HI70030 12880 µS/cm and HI70038 6.44 ppt calibration solution sachets, HI700601 electrode cleaning solution sachets (2), 100 mL beaker, 1.5V AAA batteries (3), calibration certificate of meter, calibration certificate of probe, instruction manual and HI710142 rugged carrying case.</p>	

\* the pH range is limited from 0 to 13 pH and the temperature range from 0 to 50°C (32 to 122°F) using HI12883 probe  
 \*\* displays µS for µS/cm  
 \*\* displays mS for mS/cm

HI9814

## pH / EC / TDS / Temperature Meter

with Multiparameter Probe

- Simultaneous, pH, EC/TDS and temperature measurements on a large three-line LCD display;
- User-friendly Design
  - With only two buttons, meter operation could not be simpler. Two buttons allow you to quickly adjust settings, select the measurement range, and choose calibration buffer sets.



- **Watertight Connection**
  - A Quick Connect DIN connector makes attaching and removing the probe simple and easy. The rubber coating protects the cable and creates a sealed connection for added reliability.
- **Probe Condition**
  - An on-screen indicator provides visual confirmation that your probe is working at its best.
- **Large LCD**
  - A multilevel display provides at-a-glance readings of your most important numbers from any angle.
- **Durable IP67 waterproof Casing**
  - Designed to withstand the knocks, drops, and spills of real life, the new IP67 body ensures top performance in any environment. These meters are totally protected against dust and water intrusion from any direction.
- On-screen calibration tags
- mV of pH measurement for electrode check
- Selectable temperature unit (°C or °F)
- Battery life indication and low battery detection



HI9814 is a durable, portable pH, conductivity, total dissolved solids and temperature meter for most measurements encountered in hydroponics, aquaponics or general agriculture applications. All operations and settings, are made through only two buttons and the housing is waterproof and rated for IP67 conditions. User-selectable features include selectable TDS factors of 0.5 and 0.7 as well as auto-off after 8 minutes or 60 minutes to prolong battery life.

The supplied HI1285-7 multiparameter probe measures pH, EC/TDS, and temperature in one convenient, rugged probe.



- **Calibrate pH and EC with one solution**
  - The HI9814 offers a quick calibration feature that allows for calibration of both parameters with a single solution. Simply enter calibration mode and the meter will automatically detect and calibrate pH and EC sensors. EC calibration is automatically applied to TDS readings.



- Optional shockproof silicon rubber boot
- Specially designed to protect your instrument from damage or impact

**HI710030** Green



### HI1285-7 Multiparameter Probe

- 3 sensors in a single probe
- Gel filled maintenance free pH electrode
- Amplified pH electrode
- Polypropylene body
  - The polypropylene body houses all the sensors in a single body design and is durable. The probe is gel filled for maintenance free operation. It does not have to be refilled periodically.

The specially engineered HI1285-7 pH/EC/TDS/temperature probe utilizes a fiber junction and gel electrolyte which provides a fast response and reduced potential for contamination. These features make this probe ideal for use in fertilizer solutions.

A solid-state preamplifier is integrated into the probe to protect the pH measurement from transient electrical noise. Sources of electrical noise include ballasts used in lighting and pumps to circulate water and nutrient solutions.

The HI1285-7 probe features a Quick Connect DIN connector that makes a waterproof connection with the meter.

#### Specifications

#### HI9814

pH	Range*	-2.00 to 16.00 pH
	Resolution	0.01 pH
	Accuracy	±0.02 pH
	Calibration	automatic, one or two-point calibration (using pH 4.01, 7.01, 10.01 buffers); one-point calibration using quick calibration solution
	Temperature Compensation	automatic
pH-mV	Range	±825 mV
	Resolution	1 mV
	Accuracy	±1 mV
EC	Range	0.00 to 6.00 mS/cm**
	Resolution	0.01 mS/cm
	Accuracy	±2% F.S.
	Calibration	automatic, one-point at 1.41 mS/cm or 5.00 mS/cm; one-point calibration using quick calibration solution
	Temperature Compensation	automatic, with $\beta = 1.9\%/^{\circ}\text{C}$
TDS	Range	0 to 3000 ppm (500 CF); 0 to 3999 ppm (700 CF)
	Resolution	10 ppm (mg/L)
	Accuracy	±2% F.S.
	Conversion Factor (CF)***	0.5 (500 ppm) or 0.7 (700 ppm)
Temperature	Range*	-5.0 to 105.0°C / 23.0 to 221.0°F
	Resolution	0.1°C/0.1°F
	Accuracy	±0.5°C / ±1.0°F
Additional Specifications	Probe (included)	HI1285-7 pH/EC/TDS/temperature sensor, DIN connector and 1 m (3.3') cable
	Battery Type/Life	1.5V AAA (3) /approx. 500 hours of continuous use
	Auto-off	user selectable: after 8 min, 60 min or disabled
	Environment	0 to 50°C (32 to 122°F); RH max. 100%
	Meter Dimensions	154 x 63 x 30 mm (6.1 x 2.5 x 1.2")
	Meter Mass (with batteries)	196 g (6.91 oz.)
	Casing Ingress Protection Rating	IP67
Ordering Information	<b>HI9814</b> is supplied with HI1285-7 pH/EC/TDS probe with built-in temperature sensor, DIN connector and 1m (3.3') cable, HI50036 Quick calibration solution sachets (3), HI700661 electrode cleaning solution sachets for agriculture (3), 100 mL beaker, 1.5V AAA batteries (3), calibration certificate of meter, calibration certificate of probe, instruction manual and rugged carrying case.	
Accessories	green carrying case	

\* the pH range is limited from 0 to 13 pH and the temperature range from 0 to 50°C (32 to 122°F) using HI1285-7 probe.

\*\* mS/cm is displayed as mS on the display.

\*\*\* TDS Conversion Factor: 1000 µS/cm = 500 ppm with 0.5 CF.

pH and Quick Cal solutions begin on page 2.181; EC and TDS solutions begin on page 5.36; See page 7.58 for probe specifications



### HI12943 pH Electrode

HI9814 is also compatible with the HI12943 pH electrode.

See page 2.139 for more information

HI9813-51 · HI9813-61

## pH/EC/TDS/ Temperature Portable Meter

- Waterproof
- CAL Check™ (HI9813-61)
  - Allows the user to easily check the probe calibration status at any time.
- Variable EC to TDS conversion factor
  - Factor automatically adjusts from 0.56 to 0.78 based on actual EC readings
  - Factor based on 442 curve for natural water
- Automatic Temperature Compensation
  - All readings are compensated for variations in temperature
- Low Battery Indicator

The HI9813-61 and HI9813-51 portable meters feature a large LCD which displays either pH, EC, TDS or temperature readings along with tutorial instructions. The pH readings are displayed with a 0.1 resolution and an accuracy of  $\pm 0.1$  pH while the EC and TDS readings are displayed with a 0.01 mS/cm and 1 ppm (mg/L) resolution and 2% full scale accuracy. The EC range of both meters is from 0.00 to 4.00 mS/cm and TDS is from 0 to 1999 ppm. The temperature correction coefficient ( $\beta$ ) is fixed at 2 %/°C and allows for automatic temperature compensated measurements of EC and TDS. These meters are calibrated manually to a single point with the use of two trimmers. pH is calibrated to pH 7.01 while EC/TDS is calibrated to either 1.41 mS/cm (1413  $\mu$ S/cm) or 1500 ppm. The LCD screen has battery life indicator as well as on-screen tutorial messages.

No probe changes are required when switching your measured parameter between pH, conductivity and TDS. These multiparameter meters reduce the number of instruments required for daily water quality analysis.

The supplied probe on both models feature a polypropylene body, amplified pH electrode with a built-in EC/TDS and temperature sensors. The amplifier for the pH electrode prevents interference from humidity and electrical noise from common sources including from motors, ballasts or pumps. The HI9813-61 and HI9813-51 are versatile meters for the agriculture, greenhouse and hydroponics industries.



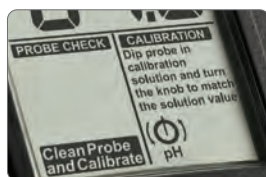
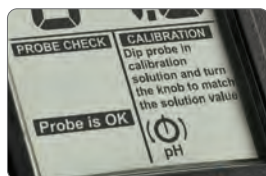
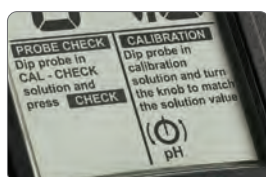

## HI9813-61 CAL Check™ Feature

The HI9813-61's CAL Check feature alerts users if there is a problem with the pH electrode. This feature is important for customers that calibrate only to pH 7.0; if there is a fracture on the pH glass of the electrode, the pH meter will always display pH 7.0 regardless of the solution being measured. This can be disastrous for the person that calibrates at pH 7.0 and takes readings of samples with an expected pH of 7.0. The user will never be aware that there is a problem. Placing the HI1285-61 pH/EC electrode in HI50021 CAL Check solution and pressing the "Check" button helps users determine if the probe needs to be calibrated, cleaned or replaced. The meter runs CAL Check diagnostics and will display either "Probe is OK" or "Clean Probe and Calibrate". If the reading is around pH 4.0 when the probe is placed in the solution then the probe is broken and needs to be replaced.



## HI1285 series probes

These meters are supplied with a polypropylene body pH/EC/TDS/temperature probe. The pH, EC, TDS, and temperature sensor are housed in a single body that connects to the meter with a DIN connector.

- **3 sensors in a single probe**
- **Amplified pH electrode**
  - The pH electrode circuit has a built-in amplifier that will reduce the effects of electrical noise on the high impedance pH measurement. Examples of sources of electrical noise include motors, ballasts, and pumps which are common in greenhouses.
- **Amperometric EC/TDS sensor**
  - The EC/TDS readings are performed by an amperometric sensor. An alternating voltage is applied to the sensor and the amount of current that passes between the two stainless steel pins is dependent upon the amount of salts (fertilizer) present. A greater amount of salt present results in an increase in conductance.
- **Polypropylene body**
  - The polypropylene body houses all the sensors in a single body design and is durable. The probe is gel filled for maintenance free operation. It does not have to be refilled periodically.

Specifications		HI9813-51	HI9813-61 (with CAL Check)
pH	Range	0.0 to 14.0 pH	0.0 to 14.0 pH
	Resolution	0.1 pH	0.1 pH
	Accuracy	±0.1 pH	±0.1 pH
EC	Range	0.00 to 4.00 mS/cm	0.00 to 4.00 mS/cm
	Resolution	0.01 mS/cm	0.01 mS/cm
	Accuracy	±2% F.S.	±2% F.S.
TDS	Range	0 to 1999 ppm (mg/L)	0 to 1999 ppm (mg/L)
	Resolution	1 ppm (mg/L)	1 ppm (mg/L)
	Accuracy	±2% F.S.	±2% F.S.
Temperature	Range	0.0 to 60.0°C	0.0 to 60.0°C
	Resolution	0.1°C	0.1°C
	Accuracy	±0.5°C	±0.5°C
Additional Specifications	TDS Conversion Factor	0.56 to 0.78 ppm = 1 µS/cm (according to TDS 442 curve)	0.56 to 0.78 ppm = 1 µS/cm (according to TDS 442 curve)
	pH & EC/TDS Calibration	manual, one point (all parameters except temperature)	manual, one point (all parameters except temperature)
	Temp. Compensation	automatic 0 to 70°C (32 to 158°F) with β=2%/°C (EC/TDS only)	automatic 0 to 70°C (32 to 158°F) with β=2%/°C (EC/TDS only)
	Probe	HI1285-51 polypropylene body, pre-amplified multiparameter probe with internal temperature sensor, 8-pin DIN connector and 1 m (3.3') cable (included)	HI1285-61 polypropylene body, pre-amplified multiparameter probe with CAL Check compatibility, internal temperature sensor, 8-pin DIN connector and 1 m (3.3') cable (included)
	Battery Type / Life	9V / approximately 450 hours of continuous use	
	Environment	0 to 50°C (32 to 122°F); RH max 100%	
	Dimensions	145 x 80 x 36 mm (5.7 x 3.1 x 1.4")	
Weight	230 g (8.1 oz.)		
Ordering Information		<p><b>HI9813-51</b> is supplied with HI1285-51 multiparameter probe, HI70007 pH 7.01 calibration solution sachet, HI70442 1500 ppm (mg/L) calibration solution sachet, HI70031 1413 µS/cm calibration solution sachet, HI700661 electrode cleaning solution sachets (2), battery and instructions.</p> <p><b>HI9813-61</b> is supplied with HI1285-61 multiparameter probe, HI70007 pH 7.01 calibration solution sachet, HI70442 1500 ppm (mg/L) calibration solution sachet, HI70031 1413 µS/cm calibration solution sachet, HI50021 calibration check solution sachets (2), HI700661 electrode cleaning solution sachets (2), 9v battery (1), instructions and rugged carrying case.</p>	
		<p><b>HI50021P</b> CAL Check solution sachets for HI9813-6, 20mL (25)</p>	
Accessories		<b>HI710007</b> blue shockproof rubber boot	
		<b>HI710008</b> orange shockproof rubber boot	
		<b>HI7209811</b> spare carrying case for HI981X-X series	

HI9810-61 · HI9811-51 · HI9812-51

## pH/EC/TDS/ Temperature Portable Meters

- Waterproof
- Automatic Temperature Compensation
  - All readings are compensated for variations in temperature
- Low battery indicator

HI9810-61 is a pH/EC/TDS meter designed to measure pH,  $\mu\text{S}/\text{cm}$ , mg/L and temperature in hydroponics, greenhouse, farming and ground water applications. HI9810-6 features Cal Check™, which allows the user to easily check the probe calibration status at any time.

The HI9812-51 and HI9811-51 are pH/EC/TDS meters for agriculture, greenhouse and hydroponics applications.

These meters feature a large LCD which displays either pH, EC, TDS or temperature readings along with tutorial instructions. The pH readings are displayed with a 0.1 resolution and an accuracy of  $\pm 0.1$  pH while the EC and TDS readings are displayed with a 10 mS/cm and 10 ppm (mg/L) resolution and 2% full scale accuracy. The temperature correction coefficient ( $\beta$ ) is fixed at 2 %/°C and allows for automatic temperature compensated measurements of EC and TDS. These meters are calibrated manually to a single point with the use of two trimmers. pH is calibrated to pH 7.01 while EC/TDS is calibrated to either 1.41 mS/cm (1413  $\mu\text{S}/\text{cm}$ ) or 1500 ppm. The LCD screen has battery life indicator as well as on-screen tutorial messages.

No probe changes are required when switching your measured parameter between pH, conductivity and TDS. These multiparameter meters reduce the number of instruments required for daily water quality analysis.

The supplied probe on all models feature a polypropylene body, amplified pH electrode with a built-in EC/TDS and temperature sensors. The amplifier for the pH electrode prevents interference from humidity and electrical noise from common sources including from motors, ballasts or pumps.





## HI1285-51 and HI1285-61 probes

HI9811-51 and HI9812-51 are supplied with the HI1285-51 pH/EC/TDS/temperature probe. The HI9810-61 is supplied with the HI1285-61 pH/EC/TDS/temperature probe with CAL Check. The pH, EC, TDS, and temperature sensor are housed in a single body that connects to the meter with a DIN connector.

- **Amplified pH electrode**
  - The pH electrode circuit has a built in amplifier that will reduce the effects of electrical noise on the high impedance pH measurement. Examples of sources of electrical noise include motors, ballasts, and pumps which are common in greenhouses.
- **Amperometric EC/TDS sensor**
  - The EC/TDS readings are performed by an amperometric sensor. An alternating voltage is applied to the sensor and the amount of current that passes between the two stainless steel pins is dependent upon the amount of salts (fertilizer) present. A greater amount of salt present results in an increase in conductance.
- **Polypropylene body**
  - The polypropylene body houses all the sensors in a single body design and is durable. The probe is gel filled for maintenance free operation. It does not have to be refilled periodically.
- **3 sensors in a single probe**
- **Gel filled maintenance free pH electrode**

Specifications	HI9810-61	HI9811-51	HI9812-51	
pH	Range	0.0 to 14.0 pH	0.0 to 14.0 pH	
	Resolution	0.1 pH	0.1 pH	
	Accuracy	±0.1 pH	±0.1 pH	
EC	Range	0 to 6000 µS/cm	0 to 1990 µS/cm	
	Resolution	10 µS/cm	10 µS/cm	
	Accuracy	±2% F.S.	±2% F.S.	
TDS	Range	0 to 3000 ppm (mg/L)	0 to 1990 ppm (mg/L)	
	Resolution	10 ppm (mg/L)	10 ppm (mg/L)	
	Accuracy	±2% F.S.	±2% F.S.	
Temperature	Range	0 to 70°C	0 to 60°C	
	Resolution	0.1°C	10°C	
	Accuracy	±0.5°C	±1°C	
Additional Specifications	TDS Conversion Factor	0.5 ppm (mg/L) = 1 µS/cm	0.5 ppm (mg/L) = 1 µS/cm	
	pH Calibration	manual, 1-point through offset trimmer		
	EC/TDS Calibration	manual, 1-point through slope trimmer		
	EC/TDS Temperature Compensation	automatic from 0 to 70°C (32 to 158°F) with $\beta = 2\% / ^\circ\text{C}$		
	Probe (included)	HI1285-61 polypropylene body, pre-amplified multiparameter probe with CAL Check, internal temperature sensor, 8-pin DIN connector and 1 m (3.3') cable	HI1285-51 polypropylene body, pre-amplified multiparameter probe with internal temperature sensor, 8-pin DIN connector and 1 m (3.3') cable	
	Battery Type / Life	9V / approximately 450 hours of continuous use		
	Environment	0 to 50°C (32 to 122°F); RH max 100%		
	Dimensions	145 x 80 x 36 mm (5.7 x 3.1 x 1.4")		
	Weight	230 g (8.1 oz.)		
	Ordering Information	<p><b>HI9810-61</b> is supplied with HI1285-61 multiparameter probe with CAL Check, HI70007 pH 7.01 calibration solution sachet, HI70032 1382 ppm (mg/L) calibration solution sachet, HI70031 1413 µS/cm calibration solution sachet, HI700661 electrode cleaning solution sachets (2), 9v battery (1), instructions and rugged carrying case.</p> <p><b>HI9811-51</b> and <b>HI9812-51</b> are supplied with HI1285-51 multiparameter probe, HI70007 pH 7.01 calibration solution sachet, HI70032 1382 ppm (mg/L) calibration solution sachet, HI70031 1413 µS/cm calibration solution sachet, HI700661 electrode cleaning solution sachets (2), 9v battery (1), instructions and rugged carrying case.</p>		
Accessories	<p><b>HI710007</b> blue shockproof rubber boot</p> <p><b>HI710008</b> orange shockproof rubber boot</p> <p><b>HI7209811</b> spare carrying case for HI981X-X series</p>			



Code	HI1285-7	HI1285-61	HI1285-51	HI12883
Description	pre-amplified pH and EC probe	pre-amplified pH and EC probe	pre-amplified pH and EC probe	pre-amplified pH and EC probe
Reference	single, Ag/AgCl	single, Ag/AgCl	single, Ag/AgCl	single, Ag/AgCl
Junction / Flow Rate	cloth	cloth	cloth	cloth
Electrolyte	gel	gel	gel	gel
Max Pressure	0.1 bar	0.1 bar	0.1 bar	1 bar
Range	pH: 0 to 13 / EC T: 0 to 50°C (32 to 122°F) - LT	pH: 0 to 13 / EC T: 0 to 50°C (32 to 122°F) - LT	pH: 0 to 13 / EC T: 0 to 50°C (32 to 122°F) - LT	pH: 0 to 13 / EC T: 0 to 50°C (32 to 122°F) - LT
Tip / Shape	spheric (dia: 8.0 mm)	spheric (dia: 8.0 mm)	spheric (dia: 8.0 mm)	spheric (dia: 8.5 mm)
Glass Type	LT (low temperature)	LT (low temperature)	LT (low temperature)	LT (low temperature)
Temperature Sensor	yes	yes	yes	yes
Amplifier	yes	yes	yes	yes
Body Material	polypropylene	polypropylene	polypropylene	polypropylene
Cable	7-pole; 1 m (3.3')	7-pole; 1 m (3.3')	7-pole; 1 m (3.3')	7-pole; 1 m (3.3')
Recommended Use	greenhouses, hydroponics	greenhouses, hydroponics, environmental monitoring, water treatment, boilers, cooling towers	greenhouses, hydroponics, environmental monitoring, water treatment, boilers, cooling towers	general purpose, water treatment, agriculture, boilers, cooling towers
Plug	Quick Connect DIN To be used with HI9814	DIN with CAL Check™ To be used with HI9813-61 and HI9810-61	DIN To be used with HI9811-51, HI9812-51 and HI9813-51	Quick Connect DIN To be used with HI991300 and HI991301





Introduction..... 8.8

Stirrers .....8.3

- Standard .....8.3
- Heavy-Duty.....8.4
- Compact, Round Edge  
with electrode holder.....8.6
- Compact, Round Edge.....8.8



### Speedsafe™ from Hanna

There are two types of magnetic stirrers; mechanical and electronic. Most manufacturers of magnetic stirrers use the mechanical approach, using steel and aluminum for the structural material and outdated methods of speed control. These units are not only very heavy, but also very inaccurate. The use of these materials and methods appear to make the units rugged and strong, but they are instead cumbersome and obsolete.

Something as simple as completely dissolving salts in a medium is, in reality, a science. Often this cannot be achieved with simple mechanical processes. The only choice that the user has with mechanical products is to increase the stirring time or the temperature. With electronics, you can do more... the Hanna approach is electronic.

**Speed sensor and limiter:** Each Hanna stirrer is equipped with a speed sensing device (opto-sensor) coupled with an FVC (frequency voltage converter), which monitors the speed. As the speed reaches a preset maximum level, the speed limiter shuts down the VCO (voltage-controlled oscillator) to slow down the motor speed. This ensures that when the load is suddenly removed from the stirrer, the motor will not accelerate to such a high speed that will be hazardous to both the user and the stirrer; a feature not commonly found in conventional stirrers.

### Sophisticated Engineering

Parts are engineered and manufactured to strict specifications to ensure absolute reliability. All components are mounted into a molded casing covered with either ABS plastic or a stainless steel plate, which are splash-proof and chemically-resistant. Minimal vibration and a well-balanced rotating arm provide years of trouble-free operation.

HI190M • HI190M-0 • HI200M

## Our Most Popular Magnetic Mini-Stirrers

- **Compact size**
  - The compact size of these stirrers allow users to maximize bench space for efficiency and safety
- **Safety**
  - Speedsafe™ limits the maximum speed to 1000 rpm even if a load is suddenly removed
- **Built to last**
  - The ABS housing of HI190M and HI190 M-0 resists most harmful chemicals in the lab

The HI190M, HI190M-0 and HI200M are compact and lightweight, so that lack of laboratory bench space is no longer a concern.

These stirrers incorporate electronic controls that allow the user to regulate the speed with greater precision. Often, in the lab, a sample is removed from the stirrer before reducing the speed. This would cause the motor of conventional equipment to accelerate until it is destroyed. This does not pose a problem with Hanna mini-stirrers, as the Speedsafe™ mechanism ensures that the maximum speed is never exceeded.

HI190M and HI190M-0 come supplied with an ABS cover that will resist the harmful effects of chemicals that are accidentally spilled.

HI200M has an AISI 316 stainless steel cover. This model is ideal for applications that create exothermic reactions.



- Stainless steel cover

Speedsafe™

- ABS plastic cover

Specifications	HI190M	HI190M-0	HI200M
Maximum Stirring Capacity	1 liter (0.26 gallons)	1 liter (0.26 gallons)	1 liter (0.26 gallons)
Min. Speed Range	100 rpm	100 rpm	100 rpm
Max. Speed Range	1000 rpm	1000 rpm	1000 rpm
Power Supply	110/115 VAC or 220/240 VAC, 50/60Hz	12 VDC (sold separately)	110/115 VAC or 230/240 VAC, 50/60Hz
Installation Category	II	II	II
Cover Material	ABS plastic	ABS plastic	AISI 316 stainless steel
Environment	0 to 50°C (32 to 122°F); RH max 95%	0 to 50°C (32 to 122°F); RH max 95%	0 to 50°C (32 to 122°F); RH max 95%
Dimensions	120 x 120 x 45 mm (4.8 x 4.8 x 1.8")	120 x 120 x 45 mm (4.8 x 4.8 x 1.8")	120 x 120 x 45 mm (4.8 x 4.8 x 1.8")
Weight	640 g (1.4 lbs.)	610 g (1.3 lbs.)	710 g (1.6 lbs.)
<b>Ordering Information</b>	<b>HI190M-1</b> (110/115 Vac), <b>HI190M-2</b> (230/240 Vac), <b>HI190M-0</b> (12 VDC), <b>HI200M-1</b> (110/115 Vac) and <b>HI200M-2</b> (230/240 Vac) mini-stirrers are supplied with micro stir bar and instructions.		
<b>Accessories</b>	<b>HI731319</b> Magnetic micro stir bar (10)		

HI300N • HI310N

## Heavy-duty Magnetic Stirrers



- Stainless steel cover

HI300N and HI310N are heavy-duty stirrers. HI300N can stir up to 2.5 liters (0.66 gallons) of liquid and the HI310N can stir up to 5.0 liters (1.3 gallons). This makes them perfect for laboratory use as well as for use in production. Electronic controls are incorporated into these stirrers that allow the user to regulate the speed with greater precision. With Hanna's Speedsafe™, a limiter will assure that the maximum speed will never be exceeded.

HI310N also has an automatic feedback feature. The motor is electronically controlled to maintain the chosen speed as the load changes. If the viscosity or the level (fluid weight) increases or decreases, the circuitry will adjust the output power to keep the speed constant.

Specifications	HI300N	HI310N
Maximum Stirring Capacity	2.5 liters (0.66 gallons)	5 liters (1.3 gallons)
Min. Speed Range	100 rpm	
Max. Speed Range	800 to 1000 rpm	
Auto-Feedback	-	standard
Power Supply	110/115 VAC or 230/240 VAC, 50/60 Hz	
Installation Category	II	
Cover Material	AISI 316 stainless steel	
Environment	0 to 50°C (32 to 122°F); RH max 95%	
Dimensions	180 x 180 x 70 mm (7.1 x 7.1 x 2.8")	
Weight	1.4 kg (3.1 lbs.)	
<b>Ordering Information</b>	<b>HI300N-1</b> (115V), <b>HI300N-2</b> (230V), <b>HI310N-1</b> (115V), and <b>HI310N-2</b> (230V) are supplied with micro stir bar and instructions.	
<b>Accessories</b>	<b>HI731320</b> Magnetic stir bar (10)	

HI302N

## Auto-reverse Magnetic Stirrers



- Stainless steel cover

The HI302N model can stir up to 2.5 liters (0.66 gallons). It is often desirable to stir your samples in two directions. This will achieve maximum homogeneity and solubility. An advanced circuit allows HI302N to reverse the direction of the stirring at a user-selected interval. The interval can be adjusted from 30 seconds up to 3 minutes. In addition to precision speed control, a limiter will also assure that the maximum speed will never be exceeded.

Hanna stirrers incorporate a VCO device that stops the motor from accelerating as soon as a load is removed (Speedsafe™).

Specifications	HI302N
Maximum Stirring Capacity	2.5 liters (0.66 gallons)
Low Speed Range	100 rpm
High Speed Range	800 to 1000 rpm
Reverse Interval	from 30 seconds to 3 minutes
Power Supply	110/115 VAC or 220/240V, 50/60 Hz
Installation Category	II
Cover Material	AISI 316 stainless steel
Environment	0 to 50°C (32 to 122°F); RH max 95%
Dimensions	180 x 180 x 70 mm (7.1 x 7.1 x 2.8")
Weight	1.4 kg (3.1 lb.)
<b>Ordering Information</b>	<b>HI302N-1</b> (115V) and <b>HI302N-2</b> (230V) are supplied with magnetic stir bar and instructions.
<b>Accessories</b>	<b>HI731320</b> Magnetic stir bar (10)

## Auto-reverse Magnetic Stirrers

with Tachometer



- Stainless steel cover

When stirring a solution, to work with a constant speed is an important factor in ensuring that the best repeatability in tests and processes is achieved. Without a tachometer, there is no way of knowing the RPMs.

HI304N is a heavy-duty stirrer with a built-in tachometer. It is often desirable to stir in two directions in order to achieve maximum homogeneity. An advanced circuit allows HI304N to reverse the direction of the stir at a user-selected interval. The interval can be adjusted from 30 seconds up to 3 minutes. In addition to precision speed control, a limiter will also assure that the maximum speed will never be exceeded (Speedsafe™). Often, a sample is removed from the stirrer before the user reduces the speed. This can cause the motor to accelerate until it is destroyed. Hanna stirrers incorporate a VCO device that will stop the motor from accelerating as soon as the load is removed.

Specifications	HI304N
Maximum Stirring Capacity	2.5 liters (0.66 gallons)
Low Speed Range	100 rpm
High Speed Range	800 to 1000 rpm
Tachometer	four-digit LCD
Reverse Interval	from 30 seconds to 3 minutes
Power Supply	110/115 VAC or 220/240 VAC, 50/60 Hz
Installation Category	II
Cover Material	AISI 316 stainless steel
Environment	0 to 50°C (32 to 122°F); RH max 95%
Dimensions / Weight	180 x 180 x 70 mm (7.1 x 7.1 x 2.8") / 1.4 kg (3.1 lbs.)
<b>Ordering Information</b>	<b>HI304N-1</b> (115V) and <b>HI304N-2</b> (230V) is supplied with magnetic stir bar and instructions
<b>Accessories</b>	<b>HI731320</b> Magnetic stir bar (10)

## Timer Controlled Magnetic Stirrers



- Stainless steel cover

HI324N is a heavy-duty stirrer that incorporates a timer control that will turn the motor off after a selected amount of time. The time is adjustable from 5 minutes to 2 hours. This feature allows the user to carry out other tasks without worrying about over or under stirring. HI324N can stir up to 5.0 liters (1.3 gallons), making it ideal for laboratory and production use.

This stirrer allows regulated speed control. A limiter will assure the maximum speed is never exceeded (Speedsafe™).

HI324N has an automatic feedback feature and incorporates an LCD tachometer. The motor is electronically-controlled to maintain the chosen speed as the load changes. If the viscosity or the level increases or decreases, the circuitry will adjust the output power. The HI324N's RPM display guarantees repeatability in QC tests and research by constantly displaying the RPMs.

Specifications	HI324N
Maximum Stirring Capacity	5 liters (1.3 gallons)
Low Speed Range	100 rpm
High Speed Range	800 to 1000 rpm
Auto-Feedback	standard
Timer Range	from 5 minutes to 2 hours
Tachometer	four-digit LCD
Power Supply	110/115 VAC or 220/240 VAC, 50/60 Hz
Installation Category	II
Cover Material	AISI 316 stainless steel
Environment	0 to 50°C (32 to 122°F); RH max 95%
Dimensions	180 x 180 x 70 mm (7.1 x 7.1 x 2.8")
Weight	1.4 kg (3.1 lb.)
<b>Ordering Information</b>	<b>HI324N-1</b> (115V) and <b>HI324N-2</b> (230V) are supplied with magnetic stir bar and instructions
<b>Accessories</b>	<b>HI731320</b> Magnetic stir bar (10)

HI181

## Compact Magnetic Mini-Stirrers

with Electrode Holder

- **Electrode holder**
  - The HI181 series features an electrode holder that fits into the base.
- **Round edge**
- **Dynamic design**
  - Easy to handle, these lightweight and compact stirrers need little room and are quickly recognizable on busy benches
- **Built to last**
  - Chemical resistant housing resists damage by accidental falls

Common stirrers are manufactured with steel and aluminum components. These units are often too large and heavy to fit in the limited space of a laboratory. Hanna HI181 series is compact, lightweight and inexpensive.

Often, in the lab, a sample is removed from a stirrer before reducing the speed. Normally, this would cause the motor to accelerate until it is destroyed. Hanna stirrers incorporate electronic controls that allow the user to regulate the speed with greater precision. In addition to speed control, the Speedsafe™ mechanism will assure that the maximum speed is never exceeded. HI181 mini-stirrers are available in eleven colors. The various colors can allow easy sample identification at a distance.

Speedsafe™



11 colors to choose from



HI181 - Black



HI181W - Arctic White



HI181F - Blue



HI181K - Orange



HI181J - Charcoal



HI181I - Ivory



HI181C - Glacier Blue



HI181A - Yellow



HI181M - Moss Green



HI181E - Green



HI181L - Lavender

**Specifications****HI181**

Maximum Stirring Capacity	1 liter (0.26 gallons)
Min. Speed Range	100 rpm
Max. Speed Range	1000 rpm
Power Supply	110/115 VAC or 220/240 VAC, 50/60 Hz
Installation Category	II
Cover Material	ABS plastic
Environment	0 to 50°C (32 to 122°F); RH max 95%
Dimensions	137 mm (dia) x 51 mm (h)
Weight	640 g (1.4 lbs.)

**Accessories**

**HI731319** Magnetic micro stir bar (10)

**Ordering Information**

All models include electrode holder, micro stir bar and instructions

<b>HI181-1</b>	Black mini-stirrer (115V)
<b>HI181-2</b>	Black mini-stirrer (230V)
<b>HI181W-1</b>	Arctic White mini-stirrer (115V)
<b>HI181W-2</b>	Arctic White mini-stirrer (230V)
<b>HI181F-1</b>	Blue mini-stirrer (115V)
<b>HI181F-2</b>	Blue mini-stirrer (230V)
<b>HI181K-1</b>	Orange mini-stirrer (115V)
<b>HI181K-2</b>	Orange mini-stirrer (230V)
<b>HI181J-1</b>	Charcoal mini-stirrer (115V)
<b>HI181J-2</b>	Charcoal mini-stirrer (230V)
<b>HI181I-1</b>	Ivory mini-stirrer (115V)
<b>HI181I-2</b>	Ivory mini-stirrer (230V)
<b>HI181C-1</b>	Glacier Blue mini-stirrer (115V)
<b>HI181C-2</b>	Glacier Blue mini-stirrer (230V)
<b>HI181A-1</b>	Yellow mini-stirrer (115V)
<b>HI181A-2</b>	Yellow mini-stirrer (230V)
<b>HI181M-1</b>	Moss Green mini-stirrer(115V)
<b>HI181M-2</b>	Moss Green mini-stirrer (230V)
<b>HI181E-1</b>	Green mini-stirrer(115V)
<b>HI181E-2</b>	Green mini-stirrer (230V)
<b>HI181L-1</b>	Lavender mini-stirrer(115V)
<b>HI181L-2</b>	Lavender mini-stirrer (230V)



11 colors to choose from



HI180 - Black



HI180W - Arctic White



HI180F - Blue



HI180K - Orange



HI180J - Charcoal



HI180I - Ivory



HI180C - Glacier Blue



HI180A - Yellow



HI180M - Moss Green



HI180E - Green



HI180L - Lavender

### Specifications

### HI180

Maximum Stirring Capacity	1 liter (0.26 gallons)
Min. Speed Range	100 rpm
Max. Speed Range	1000 rpm
Power Supply	110/115 VAC or 220/240 VAC, 50/60 Hz
Installation Category	II
Cover Material	ABS plastic
Environment	0 to 50°C (32 to 122°F); RH max 95%
Dimensions	137 mm (dia) x 51 mm (h)
Weight	640 g (1.4 lbs.)
<b>Accessories</b>	<b>HI731319</b> Magnetic micro stir bar (10)

HI180

## Compact Magnetic Mini-Stirrers

- Round edge
- Dynamic design
  - Easy to handle, these lightweight and compact stirrers need little room and are quickly recognizable on busy benches
- Built to last
  - Chemical resistant housing resists damage by accidental falls

Hanna HI180 series is compact, lightweight and inexpensive.

Often, in the lab, a sample is removed from a stirrer before reducing the speed. Normally, this would cause the motor to accelerate until it is destroyed. Hanna stirrers incorporate electronic controls that allow the user to regulate the speed with greater precision. In addition to speed control, the Speedsafe™ mechanism will assure that the maximum speed is never exceeded. HI180 mini-stirrers are available in eleven colors. The various colors can allow easy sample identification at a distance.

### Ordering Information

All models are supplied with micro stir bar and instructions

<b>HI180-1</b>	Black mini-stirrer (115V)
<b>HI180-2</b>	Black mini-stirrer (230V)
<b>HI180W-1</b>	Arctic White mini-stirrer (115V)
<b>HI180W-2</b>	Arctic White mini-stirrer (230V)
<b>HI180F-1</b>	Blue mini-stirrer (115V)
<b>HI180F-2</b>	Blue mini-stirrer (230V)
<b>HI180K-1</b>	Orange mini-stirrer (115V)
<b>HI180K-2</b>	Orange mini-stirrer (230V)
<b>HI180J-1</b>	Charcoal mini-stirrer (115V)
<b>HI180J-2</b>	Charcoal mini-stirrer (230V)
<b>HI180I-1</b>	Ivory mini-stirrer (115V)
<b>HI180I-2</b>	Ivory mini-stirrer (230V)
<b>HI180C-1</b>	Glacier Blue mini-stirrer (115V)
<b>HI180C-2</b>	Glacier Blue mini-stirrer (230V)
<b>HI180A-1</b>	Yellow mini-stirrer (115V)
<b>HI180A-2</b>	Yellow mini-stirrer (230V)
<b>HI180M-1</b>	Moss Green mini-stirrer (115V)
<b>HI180M-2</b>	Moss Green mini-stirrer (230V)
<b>HI180E-1</b>	Green mini-stirrer (115V)
<b>HI180E-2</b>	Green mini-stirrer (230V)
<b>HI180L-1</b>	Lavender mini-stirrer (115V)
<b>HI180L-2</b>	Lavender mini-stirrer (230V)





Introduction.....9.2

- Product Spotlights.....9.3
- Single Parameter Quick Reference.....9.4
- Multiparameter Quick Reference .....9.6
- Backpack Lab® Quick Reference.....9.7

Chemical Test Kits.....9.8

- Olive Oil Test Kit .....9.8
- Single Parameter Test Kits ..... 9.10
- Multiparameter Test Kits.....9.31
  - Agriculture .....9.31
  - Boiler and Feedwater .....9.32
  - Cooling and Boiler .....9.33
  - Environmental Monitoring .....9.34
  - Marine .....9.35
  - Swimming Pools .....9.36
  - Water Quality .....9.37

Backpack Lab™ Educational Test Kits ..... 9.39

- Water Quality .....9.39
- Soil Quality ..... 9.41
- Marine Science .....9.43

Reagents.....9.44



## Hanna Chemical Test Kits

### *Single or Combination Kits*

Hanna test kits are a simple way to perform an accurate chemical analysis. The wide variety of single parameter test kits presented in this section includes colorimetric, checker disc, titration and turbidimetric methods.

Quick and easy to use, Hanna colorimetric chemical test kits are the ideal solution for water analysis of many chemical parameters. The kits are equipped with a transparent container which has the color scale right next to the sample being tested. This makes the color comparison process simple and error free. The reagents are either liquid or powder, depending on the parameter to be measured.

Hanna Checker® Disc test kits use the technology of colorimetric kits to provide greater accuracy and resolution. The Checker® Disc is a color comparison wheel shaded from dark to light in proportion to the concentration of the chemical parameter being tested. The user just needs to put both the blank and the reacted cuvettes inside the Checker® Disc. By turning the wheel, the user can then visually find the concentration that best equals the reacted sample. This technique enhances resolution and accuracy.

Titration test kits are easy to use without any loss of resolution and accuracy. To determine the concentration of the chemical parameter, these kits utilize a titration technique which consists of counting the number of drops of titrant necessary to cause a color change in the sample. Dropper bottles make titration extremely quick and easy without compromising accuracy. The endpoint can be determined with enhanced accuracy and simplicity.

Hanna test kits are supplied ready to use, complete with all the necessary accessories. They are designed to help you to work better, faster and safer. All Hanna chemical test kits use color-coded dropper bottles which are easy to recognize during analysis.

With some kits, a plastic beaker is provided featuring a ported cap to prevent spills and waste.

Every kit is manufactured according to the highest quality standards and a Safety Data Sheet (SDS) is available for each product, online.

### Designed for Specific Applications

Hanna combination chemical test kits are tailor made for specific applications:

#### Includes all you need

Hanna test kits include all the necessary reagents and accessories for their specific application.

#### Ideal for field measurements

Multiparameter test kits from Hanna are equipped with a hard carrying case helps to keep your equipment neat, organized and easy to carry around in the field. Our carrying cases are rugged, built to last, and easily refilled with replacement reagents as needed.

#### Comprehensive Instructions

Every chemical test kit is supplied with a comprehensive, easy-to-understand instruction manual. The manuals guide you through the analysis step-by-step, making it easy for even non-technical personnel to perform tests.

#### One more advantage: Hanna's exclusive pHep® for pH measurements

For those kits that offer pH measurements, Hanna has included the exclusive pHep® electronic tester so that your pH analysis will always be quick and reliable. Traditional pH test strips have limited accuracy and do not cover the entire pH range. Due to the pHep's long life, high accuracy and extended range, these problems are avoided.



HI3887

## Quick-Check Swimming Pool Test Kit

*Free Chlorine and pH*

The HI3887 is a colorimetric chemical test kit that determines the free chlorine concentration and pH level in samples within a 0.0 to 2.5 mg/L (ppm)  $\text{Cl}^-$  range and 6.0 to 8.5 pH range. The HI3887 is supplied with all of the necessary reagents and equipment to perform the analysis. The test kit contains enough reagents to perform approximately 50 tests for free chlorine and 100 tests for pH.

See page 9.36

HI3896

## Hanna Soil Test Kit

The chemical composition of soil includes pH and chemical elements. Soil analysis is necessary for better management of fertilization and to know the residues of fertilizers in relation to the crop, tillage and the most suitable plant choice for soil composition. An analysis can highlight shortages and help the understanding of the causes of an abnormal growth. By using the Hanna soil test, it is possible to measure pH and the most important elements for plant growth: nitrogen (N), phosphorus (P) and potassium (K).

Testing the soil during each crop cycle and comparing the results with plant growth can be a useful information for subsequent cultivations.

See page 9.31



HI3899BP

## Backpack Lab® Marine Science Educational Test Kit

Backpack Lab® is designed with all the necessary components in one place, reducing the chance of misplacing an item. Ideal for transporting, this durable backpack is great to take to the field for accurate on-site measurements.

This kit is designed to provide a complete unit for teachers to introduce students to important marine science topics. The teacher's guide provides detailed background information for marine science lessons and activities that can be adapted to various grade levels. Field tests are included to complement classroom lessons. All materials fit easily into the supplied backpack for easy transport.

See page 9.43



## Single Parameter Test Kits

	Parameter	Method	Range	# of Tests	Code	Page	
Acidity	Acidity (as % Oleic acid)	titration	0.00 - 1.00 % acidity	6	HI3897	9.8	
	Acidity (as CaCO <sub>3</sub> ) Methyl/Orange and Total	titration	0-100 mg/L (ppm); 0-500 mg/L (ppm)	110 avg.	HI3820	9.10	
Alkalinity	Alkalinity (as CaCO <sub>3</sub> ) Phenolphthalein and Total	titration	0-100 mg/L (ppm); 0-300 mg/L (ppm)	110 avg.	HI3811	9.10	
Ammonia	Ammonia (as NH <sub>3</sub> -N) (Fresh Water)	colorimetric	0.0-2.5 mg/L (ppm)	25 avg.	HI3824	9.11	
	Ammonia (as NH <sub>3</sub> -N) (Saltwater)	colorimetric	0.0-2.5 mg/L (ppm)	25 avg.	HI3826	9.11	
Boron	Boron	titration	0.0-5.0 mg/L (ppm)	100	HI38074	9.12	
Bromine	Bromine	colorimetric	0.0-3.0 mg/L (ppm)	60 avg.	HI3830	9.12	
Carbon Dioxide	Carbon Dioxide	titration	0.0-10.0 mg/L (ppm); 0.0-50.0 mg/L (ppm); 0-100 mg/L (ppm)	110 avg.	HI3818	9.13	
Chloride	Chloride (as Cl <sup>-</sup> )	titration	0-100 mg/L (ppm); 0-1000 mg/L (ppm)	110 avg.	HI3815	9.13	
Chlorine	Chlorine Free	colorimetric	0.0-2.0 mg/L (ppm)	50 avg.	HI3829F	9.14	
	Chlorine Free	colorimetric	0.0-2.5 mg/L (ppm)	50 avg.	HI3831F	9.14	
	Chlorine Free	checker disc	0.0-3.5 mg/L (ppm)	100	HI3875	9.15	
	Chlorine Free	checker disc	0.00-0.70 mg/L (ppm); 0.0-3.5 mg/L (ppm)	200	HI38018	9.15	
	Chlorine Free & Total	checker disc	0.00-0.70 mg/L (ppm); 0.0-3.5 mg/L (ppm)	200	HI38017	9.16	
	Chlorine Free & Total	checker disc	0.00-0.70 mg/L (ppm); 0.0-3.5 mg/L (ppm); 0.0-10.0 mg/L (ppm)	200	HI38020	9.16	
	Chlorine Total	colorimetric	0.0-2.5 mg/L (ppm)	50 avg.	HI3831T	9.17	
	Chlorine Total	titration	10-200 mg/L (ppm)	100	HI38023	9.17	
	Chromium	Chromium (as CrVI)	colorimetric	0.0-1.0 mg/L (ppm)	100 avg.	HI3846	9.18
	Copper	Copper	colorimetric	0.0-2.5 mg/L (ppm)	100	HI3847	9.18
Formaldehyde	Formaldehyde	titration	0-1%; 0-10%	110 avg.	HI3838	9.19	
Glycol	Glycol	visual	Present/Absent	25	HI3859	9.19	
Hardness	Hardness (as CaCO <sub>3</sub> ) Total	titration	0 - 80 TH		HI3890 (Pool Line)	9.20	
	Hardness (as CaCO <sub>3</sub> ) Total	titration	0.0-30.0 mg/L (ppm); 0-300 mg/L (ppm)	100 avg.	HI3812	9.20	
	Hardness (as CaCO <sub>3</sub> ) Total	titration	0-30 gpg	100	HI38033	9.20	
	Hardness (as CaCO <sub>3</sub> ) Total	titration	0-150 mg/L (ppm)	50 avg.	HI3840	9.21	
	Hardness (as CaCO <sub>3</sub> ) Total	titration	40-500 mg/L (ppm)	50 avg.	HI3841	9.21	
	Hardness (as CaCO <sub>3</sub> ) Total	titration	400-3000 mg/L (ppm)	50 avg.	HI3842	9.21	
Hydrogen Peroxide	Hydrogen Peroxide	titration	0.00-2.00 mg/L; 0.0-10.0 mg/L	100 avg.	HI3844/ HI38444 (Pool Line)	9.22	
Hypochlorite	Hypochlorite (as Cl <sub>2</sub> )	titration	50-150 g/L (ppt)	100 avg.	HI3843/ HI38434 (Pool Line)	9.22	
Iron	Iron	colorimetric	0-5 mg/L (ppm)	50 avg.	HI3834	9.23	
	Iron	checker disc	0.00-1.00 mg/L (ppm)	100	HI38039	9.23	
	Iron	checker disc	0.0-5.0 mg/L (ppm)	100	HI38040	9.24	
	Iron	checker disc	0.0-10.0 mg/L (ppm)	100	HI38041	9.24	

	Parameter	Method	Range	# of Tests	Code	Page
Nitrate	Nitrate (as NO <sub>3</sub> <sup>-</sup> -N)	colorimetric	0-50 mg/L (ppm)	100	HI3874	9.25
	Nitrate (as NO <sub>3</sub> <sup>-</sup> -N) (Irrigation Water and Soil)	checker disc	water: 0-50 mg/L (ppm); soil: 0-60 mg/L (ppm)	100 100	HI38050	9.25
Nitrite	Nitrite (as NO <sub>2</sub> <sup>-</sup> -N)	colorimetric	0.0-1.0 mg/L (ppm)	100	HI3873	9.26
Oxygen, Dissolved	Oxygen, Dissolved	titration	0.0-10.0 mg/L (ppm)	110 avg.	HI3810	9.26
Ozone	Ozone	checker disc	0.0-2.3 mg/L (ppm)	100	HI38054	9.27
Phosphate	Phosphate (PO <sub>4</sub> <sup>3-</sup> )	colorimetric	0-5 mg/L (ppm)	50	HI3833	9.27
	Phosphate (PO <sub>4</sub> <sup>3-</sup> )	checker disc	0.00-1.00 mg/L (ppm); 0.0-5.0 mg/L (ppm); 0-50 mg/L (ppm)	100	HI38061	9.28
Salinity	Salinity	titration	0.0-40.0 g/kg (ppt)	110 avg.	HI3835	9.28
Silica, HR	Silica as (SiO <sub>2</sub> )	checker disc	0-40 mg/L (ppm); 0-800 mg/L (ppm)	100	HI38067	9.29
Sulfate	Sulfate (as SO <sub>4</sub> <sup>2-</sup> )	turbidimetric	20-100 mg/L (ppm)	100	HI38000	9.29
	Sulfate (as SO <sub>4</sub> <sup>2-</sup> )	titration	100-1000 mg/L (ppm); 1000-10000 mg/L (ppm)	200	HI38001	9.30
Sulfite	Sulfite (as Na <sub>2</sub> SO <sub>3</sub> )	titration	0.0-20.0 mg/L (ppm); 0-200 mg/L (ppm)	110 avg.	HI3822	9.30

# Multiparameter Test Kits

	Parameter	Method	Range	# of Tests	Page
HI3895 Agriculture Test Kit, Basic	Nitrogen	colorimetric	traces, low, medium, high	10	9.31
	Phosphorus	colorimetric	traces, low, medium, high	10	
	pH	colorimetric	4 to 9 pH	10	
	Potassium	turbidimetric	traces, low, medium, high	10	
HI3896 Agriculture Test Kit, Professional	Nitrogen	colorimetric	traces, low, medium, high	25	9.31
	Phosphorus	colorimetric	traces, low, medium, high	25	
	pH	colorimetric	4 to 9 pH	25	
	Potassium	turbidimetric	traces, low, medium, high	25	
HI3827 Boiler and Feedwater Test Kit	Alkalinity (as CaCO <sub>3</sub> )	titration	0-100 mg/L (ppm); 0-300 mg/L (ppm)	110 avg.	9.32
	Chloride (as Cl <sup>-</sup> )	titration	0-100 mg/L (ppm); 0-1000 mg/L (ppm)	110 avg.	
	Hardness (as CaCO <sub>3</sub> )	titration	0.0-30.0 mg/L (ppm); 0-300 mg/L (ppm)	100 avg.	
	Phosphate	colorimetric	0-5 mg/L (ppm)	50	
	pH	electronic pH tester	0.0-14.0 pH	life of the meter	
	Sulfite (as Na <sub>2</sub> SO <sub>3</sub> )	titration	0.0-20.0 mg/L (ppm); 0-200 mg/L (ppm)	110 avg.	
HI3821 Cooling and Boiler Combination Test Kit	Alkalinity (as CaCO <sub>3</sub> )	titration	0-100 mg/L (ppm); 0-300 mg/L (ppm)	110 avg.	9.33
	Chloride (as Cl <sup>-</sup> )	titration	0-100 mg/L (ppm); 0-1000 mg/L (ppm)	110 avg.	
	Hardness (as CaCO <sub>3</sub> )	titration	0.0-30.0 mg/L (ppm); 0-300 mg/L (ppm)	100 avg.	
	Phosphate	colorimetric	0-5 mg/L (ppm)	50 avg.	
	Oxygen, Dissolved	titration	0.0-10.0 mg/L (ppm)	110 avg.	
	Sulfite (as Na <sub>2</sub> SO <sub>3</sub> )	titration	0.0-20.0 mg/L (ppm); 0-200 mg/L (ppm)	110 avg.	
HI3814 Environmental Monitoring Test Kit	Acidity (as CaCO <sub>3</sub> )	titration	0-100 mg/L (ppm); 0-500 mg/L (ppm)	110 avg.	9.34
	Alkalinity (as CaCO <sub>3</sub> )	titration	0-100 mg/L (ppm); 0-300 mg/L (ppm)	110 avg.	
	Carbon Dioxide	titration	0.0-10.0 mg/L (ppm); 0.0-50.0 mg/L (ppm); 0-100 mg/L (ppm)	110 avg.	
	Hardness (as CaCO <sub>3</sub> )	titration	0.0-30.0 mg/L (ppm); 0-300 mg/L (ppm)	100 avg.	
	Oxygen, Dissolved	titration	0.0-10.0 mg/L (ppm)	110 avg.	
	pH	electronic pH tester	0.0-14.0 pH	life of the meter	
HI3823 Marine Test Kit	Alkalinity (as CaCO <sub>3</sub> )	titration	0-100 mg/L (ppm); 0-300 mg/L (ppm)	110 avg.	9.35
	Carbon Dioxide	titration	0.0-10.0 mg/L (ppm); 0.0-50.0 mg/L (ppm); 0-100 mg/L (ppm)	110 avg.	
	Hardness (as CaCO <sub>3</sub> )	titration	0.0-30.0 mg/L (ppm); 0-300 mg/L (ppm)	100 avg.	
	Oxygen, Dissolved	titration	0.0-10.0 mg/L (ppm)	110 avg.	
	pH	electronic pH tester	0.0-14.0 pH	life of the meter	
	Salinity	titration	0.0-40.0 g/kg	110 avg.	
HI3887 Pool Line Quick-check Swimming Pool Test Kit	Free Chlorine	colorimetric	0-2.5 mg/L (ppm)	50 avg.	9.36
	pH	colorimetric	6.0-8.5 pH	100 avg.	
HI3817 Water Quality Test Kit	Alkalinity (as CaCO <sub>3</sub> )	titration	0-100 mg/L (ppm); 0-300 mg/L (ppm)	110 avg.	9.37
	Chloride (as Cl <sup>-</sup> )	titration	0-100 mg/L (ppm); 0-1000 mg/L (ppm)	110 avg.	
	Hardness (as CaCO <sub>3</sub> )	titration	0.0-30.0 mg/L (ppm); 0-300 mg/L (ppm)	100 avg.	
	Iron	colorimetric	0-5 mg/L (ppm)	50	
	pH	electronic pH tester	0.0-14.0 pH	life of the meter	
	Sulfite (as Na <sub>2</sub> SO <sub>3</sub> )	titration	0.0-20.0 mg/L (ppm); 0-200 mg/L (ppm)	110 avg.	



# Backpack Lab® Multiparameter Test Kits

## HI3817BP Backpack Lab® Water Quality Educational Test Kit

Parameter	Method	Range	# of Tests	Page
Acidity (CaCO <sub>3</sub> )	titration	0-100 mg/L (ppm); 0-500 mg/L (ppm)	110	
Alkalinity (CaCO <sub>3</sub> ) Phenolphthalein & Total	titration	0-100 mg/L (ppm); 0-300 mg/L (ppm)	110	
Carbon Dioxide	titration	0.0-10.0 mg/L (ppm); 0.0-50.0 mg/L (ppm) 0-100 mg/L (ppm)	110	
Oxygen, Dissolved	titration	0.0-10.0 mg/L (ppm)	110	
Hardness (CaCO <sub>3</sub> )	titration	0.0-30.0 mg/L (ppm); 0-300 mg/L (ppm)	100	
Nitrate (NO <sub>3</sub> <sup>-</sup> -N)	colorimetric	0-50 mg/L (ppm)	100	
Phosphate	colorimetric	0-5 mg/L (ppm)	50	9.39
pH	Hanna electronic Combo tester	-2 to 16 pH	life of meter	
EC	Hanna electronic Combo tester	0-3999 µS/cm	life of meter	
TDS	Hanna electronic Combo tester	0-2000 ppm	life of meter	
Temperature	Hanna electronic Combo tester	-5-60.0°C	life of meter	
Turbidity	secchi disc	-	-	

## HI3896BP Backpack Lab® Soil Quality Educational Test Kit

Nitrogen	colorimetric	traces, low, medium, high	50	
Phosphorus	colorimetric	traces, low, medium, high	50	
Potassium	turbidimetric	traces, low, medium, high	50	
	colorimetric	4 to 9 pH (1 pH increments)	50	
pH	Hanna electronic Combo tester	-2 to 16 pH	life of meter	9.41
EC	Hanna electronic Combo tester	0 to 3999 µS/cm	life of meter	
TDS	Hanna electronic Combo tester	0 to 2000 ppm	life of meter	
Temperature	Hanna electronic Combo tester	-50.0 to 220°C	life of meter	

## HI3899BP Backpack Lab® Marine Science Educational Test Kit

Acidity (CaCO <sub>3</sub> )	titration	0-100 mg/L (ppm); 0-500 mg/L (ppm)	110 avg.	
Alkalinity (CaCO <sub>3</sub> ) Phenolphthalein & Total	titration	0-100 mg/L (ppm); 0-300 mg/L (ppm)	110 avg.	
Ammonia (as NH <sub>3</sub> -N)	colorimetric	0.0-2.5 mg/L (ppm)	25 avg.	
Carbon Dioxide (CO <sub>2</sub> )	titration	0.0-10.0 mg/L (ppm); 0.0-50.0 mg/L (ppm)	110 avg.	
Oxygen, Dissolved	titration	0.0-10.0 mg/L (ppm)	110 avg.	
Nitrite	colorimetric	0.0-9.0 mg/L (ppm)	100	
Nitrate (NO <sub>3</sub> <sup>-</sup> -N)	colorimetric	0-50 mg/L (ppm)	100	
Phosphate (PO <sub>4</sub> <sup>3-</sup> )	colorimetric	0-5 mg/L (ppm)	50	9.43
Salinity	titration	0.0-40.0 g/kg	110 avg.	
pH	Hanna electronic Combo tester	-2 to 16 pH	life of meter	
EC	Hanna electronic Combo tester	0-3999 µS/cm	life of meter	
TDS	Hanna electronic Combo tester	0-2000 ppm	life of meter	
Temperature	Hanna electronic Combo tester	-5-60.0°C	life of meter	
Turbidity	secchi disc	-	-	

HI3897

## Olive Oil Acidity Test Kit

Now there is an easy, affordable and accurate way to determine the quality, classification and freshness of your olive oil.

Acidity (as % oleic acid) is the most fundamental measurement of olive oil. It is the primary indicator of olive oil purity and freshness.

The quality of olive oil is directly related to the degree of breakdown of the fatty acids in the oil. As the bound fatty acids break down, free fatty acids are formed, which increase the % acidity of the oil. Acidity, is a measure of the free fatty acid present in the oil, which is directly related to its purity.

The quality of olive oil can be adversely affected during either maturation or by environmental conditions. Mishandling, processing and bruising during harvesting can also contribute to a breakdown of fatty acids and an increase in free acidity. Improper and/or long-term storage can cause olive oil to break down and become rancid. Regular acidity testing is the best way to ensure and maintain quality and freshness.

Normally, testing acidity is a complicated process requiring the use of various chemicals in a laboratory environment. Hanna has simplified this process in an easy-to-understand test kit that can be used by almost anyone to produce quick and accurate results.

Studies have shown that the quality of olive oil has a direct impact on its health benefits. Extra Virgin Olive Oil contains higher levels of antioxidants, particularly phenols and vitamin E (because it is less processed). Antioxidants can help prevent oxidation damage to body tissue caused by free radicals. Studies have also shown that the oxidation of LDL (bad) cholesterol is associated with the hardening of arteries that can lead to heart disease.

With the HI3897 test kit, it is possible to easily and accurately test the quality of olive oil at various stages of processing and storage to monitor and maintain the highest quality.



Acidity, defined as percent oleic acid, is a parameter that indicates olive oil freshness. A high acidity value indicates the oil quality has diminished and is at risk of becoming rancid.

Acidity is used to discriminate an extra virgin olive oil from all other olive oils. According to the CEE 2568/91 regulation, olive oil is considered extra virgin when its acidity level is below 1%. A low acidity value also indicates a natural extraction process occurred soon after olive harvesting.

The HI3897 kit utilizes a titration method where the endpoint is visually determined when the color changes from yellow-green to pink.



*The HI180 is a compact and lightweight magnetic stirrer which incorporates electronic controls that allow the user to regulate the speed with precision. In addition to speed control, Hanna's Speedsafe™ system will assure that the maximum speed is never exceeded.*

### Chemical Parameters

Olive Storage Period (between harvesting and extraction)	within 48 hours	2 to 4 days	over 4 days
Acidity (as % oleic acid)	0.3	0.4	0.5





## Sensory Quality of Olive Oil

The sensory analysis of virgin olive oil is based on a panel test, developed by the International Olive Oil Council. The rating is awarded on the basis of a scale of points running from 0, which indicates that the oil has extreme defects, to 9, which indicates that the oil has no defects at all. See the following chart for sensory ratings of each grade of olive oil.

- Extra Virgin Oil >6.5
- Virgin >5.5
- Ordinary Virgin >3.5
- Virgin Lampante <3.5

Specifications	HI3897
Range	0.00 to 1.00 % acidity
Smallest Increment	0.01 mL = 0.01%
Method	titration
Sample Size	4.6 mL or 4 g
Number of Tests	6
Dimensions (kit)	112 x 390 x 318 mm (4.4 x 15.4 x 12.5")

Specifications	HI180 Magnetic Stirrer (included)
Maximum Stirring Capacity	1 L (0.26 g)
Speed Range	100 rpm min.; 1000 rpm max
Installation Category	II
Cover Material	ABS plastic
Environment	0 to 50°C (32 to 122°F) 95% RH max
Dimensions	dia. 137 mm x 51 mm (h) (5.39 x 2")
Weight	640 g (1.4 lbs.)
<b>Ordering Information</b>	<b>HI3897</b> is supplied with 6 ready-to-use bottles of organic solvent, HI180I/MB magnetic stirrer, calibrated syringe for oil dosing, calibrated syringe for titrant dosing with tip, titrant (20 mL bottle), rugged carrying case and instructions.
<b>Reagents</b>	<b>HI3897-010</b> Replacement reagents for 10 tests.

In accordance with the European Community (EC) reg. CEE2568/91 quality classification of olive oil based on acidity (expressed as percent oleic acid) is as follows:

- **Extra Virgin Olive Oil: Acidity  $\leq$  1%**
  - "Perfect flavor and odor", with a maximum acidity, expressed as oleic acid, of 1 g/100 g
- **Virgin Olive Oil: Acidity 1 - 2%**
  - "Perfect flavor and odor", with a maximum acidity, expressed as oleic acid, of 2 g/100 g
- **Ordinary Virgin Olive Oil: Acidity 2 - 3.3% (tolerance of 10%)**
  - "Good flavor and odor", with a maximum acidity, expressed as oleic acid, of 3.3 g/100 g
- **Virgin Lampante Olive Oil: + 3.3%. Not fit for human consumption**
  - "Off flavor and odor", with a maximum acidity, expressed as oleic acid, > 3.3 g/100 g

## Additional Technical Information:

Olive oil is a complex compound made of fatty acids, vitamins, volatile components, water soluble components and microscopic bits of olive. The three primary fatty acids (triglycerides) are oleic, linoleic, and linolenic.

- Palmitic Acid (16:0) = 7.5 - 20%
- Oleic Acid (18:1) = 55 - 85% olive oil composition
- Linoleic Acid (18:2) = 3.5 - 21.00% olive oil composition
- Linolenic Acid (18:3) = 0.0 - 1.5% olive oil composition

Oleic acid makes up 55 to 85% of olive oil. Oleic acid is the most abundant fatty acid found in nature.

Studies show that high concentrations of oleic acid can lower blood levels of total and LDL (bad) cholesterol, reducing the long term risk of heart disease.

## Olive Oil Acid Composition

- Palmitic Acid (16:0) = 7.5 - 20%
- Palmitoleic Acid (16:1) = 0.3 - 3.5%
- Stearic Acid (18:0) = 0.5 - 5.0%
- Oleic Acid (18:1) = 55.0 - 83.0 %
- Linoleic Acid (18:2) = 3.5 - 21.0%
- Linolenic Acid (18:3) = 0.0 - 1.5%
- Others = 1.5 - 3.2%

HI3820

## Acidity Test Kit

The HI3820 is a titration-based chemical test kit that determines the acidity concentration in two ranges: 0 to 100 mg/L and 0 to 500 mg/L CaCO<sub>3</sub>. The HI3820 is supplied with all of the necessary reagents and equipment to perform the analysis. The test kit contains enough reagents to perform approximately 110 tests.

- **Complete setup**
  - All required materials are included with the test kit, such as the sample beaker, indicator and reagent bottles, and calibrated syringe.
- **High resolution**
  - Readings from 0 to 100 mg/L are determined to 1 mg/L resolution.
  - Readings from 0 to 500 mg/L are determined to 5 mg/L resolution.
- **Replacement reagents available**
  - There is no need to buy a new kit when reagents are exhausted. The HI3820-100 can be ordered to replace the reagents supplied with the kit.

### Significance of Use

Acidity is the quantitative capacity of a water sample to neutralize a base to a predetermined pH value. Therefore, the greater acidity, the more potentially corrosive the water. Acidity can be caused by mineral acids, organic acids, and carbon dioxide in the form of carbonic acid. Today, our water supplies are becoming more contaminated with corrosive chemicals from industrial dumping and ever-growing amounts of carbon dioxide in the atmosphere. Acidity measurements are an essential monitoring device to define and control pollution in sewers, lakes, and rivers. Acidity of water is equally important to monitor in soils and fish farming to ensure an adequate growing environment.



Specifications	HI3820 Acidity (as CaCO <sub>3</sub> *)
Type	titration
Range	0-100 mg/L (ppm) 0-500 mg/L (ppm)
Smallest Increment	1 mg/L (ppm) 5 mg/L (ppm)
Method	methyl-orange/phenolphthalein
Number of Tests	110 avg.
<b>Ordering Information</b>	<b>HI3820</b> test kit comes with 10 mL dechlorinating reagent, 10 mL bromophenol blue indicator, 10 mL phenolphthalein indicator, 120 mL acidity titrant, 10 mL calibrated vessel, 50 mL calibrated vessel, and calibrated syringe with tip.
<b>Reagent</b>	<b>HI3820-100</b> Acidity (as CaCO <sub>3</sub> ), 110 tests avg

HI3811

## Alkalinity Test Kit

The HI3811 is a titration-based chemical test kit that determines the alkalinity concentration in samples within a 0 to 100 mg/L (ppm) CaCO<sub>3</sub> or 0 to 300 mg/L CaCO<sub>3</sub> range. The HI3811 is supplied with all of the necessary reagents and equipment to perform the analysis. The test kit contains enough reagents to perform approximately 110 tests.

- **Complete setup**
  - All required materials are included with the test kit, such as the sample beakers, plastic syringe, phenolphthalein indicator, and bromophenol blue indicator.
- **High resolution**
  - Readings from 0 to 100 mg/L are determined to 1 mg/L resolution
  - Readings from 0 to 300 mg/L are determined to 3 mg/L resolution
- **Replacement reagents available**
  - There is no need to buy a new kit when reagents are exhausted. The HI3811-100 can be ordered to replace the reagents supplied with the kit

### Significance of Use

Alkalinity is the quantitative capacity of a water sample to neutralize an acid to a set pH. This measurement is very important in determining the corrosive characteristics of water due primarily to hydroxide, carbonate, and bicarbonate ions. Other sources of alkalinity can be from anions that can be hydrolyzed such as phosphates, silicates, borates, fluoride, and salts of some organic acids. Alkalinity is critical in the treatments of drinking water, wastewater, boiler and cooling systems, and soils.

Alkalinity can be measured as Phenolphthalein Alkalinity and Total Alkalinity. The Phenolphthalein Alkalinity is determined by neutralizing the sample to a pH of 8.3 using a dilute hydrochloric acid solution and a phenolphthalein indicator. This process converts hydroxide ions to water, and carbonate ions to bicarbonate ions:



Since bicarbonate ions can be converted to carbonic acid with additional hydrochloric acid, the Phenolphthalein Alkalinity measures total hydroxide ions, but only half of the bicarbonate contribution. To completely convert the carbonate ions, hydrochloric acid is added until the sample pH is 4.5, which is known as Total Alkalinity:



Specifications	HI3811 Alkalinity (as CaCO <sub>3</sub> *)
Type	titration
Range	0-100 mg/L (ppm) 0-300 mg/L (ppm)
Smallest Increment	1 mg/L (ppm) 3 mg/L (ppm)
Method	phenolphthalein/bromophenol blue
Number of Tests	110 avg.
<b>Ordering Information</b>	<b>HI3811</b> test kit comes with 10 mL phenolphthalein indicator, 10 mL bromophenol blue indicator, 120 mL alkalinity titrant, 10 mL calibrated vessel, 50 mL calibrated vessel, and calibrated syringe with tip.
<b>Reagent</b>	<b>HI3811-100</b> Alkalinity (as CaCO <sub>3</sub> ), 110 tests avg

\* 1 gpg = 17 ppm CaCO<sub>3</sub>

HI3824

## Ammonia Test Kit

for Fresh Water

The HI3824 is a colorimetric chemical test kit that determines the ammonia concentration in fresh water within a 0.0 to 2.5 mg/L (ppm) range as  $\text{NH}_3\text{-N}$ . The HI3824 is supplied with all of the necessary reagents and equipment to perform the analysis. The test kit contains enough reagents for perform approximately 25 tests.

- **Complete setup**
  - All required materials are included with the test kit, such as the sample beaker, color comparison cube, and reagent dropper bottles.
- **High resolution**
  - Readings from 0.0 to 2.5 mg/L  $\text{NH}_3\text{-N}$  are determined to 0.5 mg/L resolution.
- **Replacement reagents available**
  - There is no need to buy a new kit when reagents are exhausted. The HI3824-025 can be ordered to replace the reagents supplied with the kit.

### Significance of Use

Groundwater normally contains ammonia due to bacterial decay of plants and animals. However, concentrations of ammonia in rivers and drinking water reservoirs may indicate the presence of agricultural runoff or urban pollution. When the concentration of ammonia is high enough, it can alter the smell and taste of water. In industrial applications, high concentrations of ammonia can cause corrosion in pipes. Ammonia is also monitored in fresh water aquariums and fish farming applications because of its toxicity to fish.



Specifications	HI3824 Ammonia (as $\text{NH}_3\text{-N}$ ) in fresh water
Type	colorimetric
Range	0.0-2.5 mg/L (ppm)
Smallest Increment	0.5 mg/L (ppm)
Method	Nessler
Number of Tests	25 avg.
<b>Ordering Information</b>	<b>HI3824</b> test kit comes with 20 mL plastic beaker, color comparison cube, 20 mL ammonia reagent 1 (for fresh water) and 20 mL Nessler reagent.
<b>Reagent</b>	<b>HI3824-025</b> Ammonia (fresh water) (as $\text{NH}_3\text{-N}$ ), 25 tests avg

HI3826

## Ammonia Test Kit

for Seawater

The HI3826 is a colorimetric chemical test kit that determines the ammonia concentration in seawater within a 0.0 to 2.5 mg/L (ppm) range as  $\text{NH}_3\text{-N}$ . The HI3826 is supplied with all of the necessary reagents and equipment to perform the analysis. The test kit contains enough reagents for perform approximately 25 tests.

- **Complete setup**
  - All required materials are included with the test kit, such as the sample beaker, color comparison cube, and reagent dropper bottles.
- **High resolution**
  - Readings from 0.0 to 2.5 mg/L  $\text{NH}_3\text{-N}$  are determined to 0.5 mg/L resolution.
- **Replacement reagents available**
  - There is no need to buy a new kit when reagents are exhausted. The HI3826-025 can be ordered to replace the reagents supplied with the kit.

### Significance of Use

Concentrations of ammonia in rivers, estuaries, and bays may indicate the presence of agricultural runoff or urban pollution. When the concentration of ammonia is high enough, it can prove toxic to aquatic life, affecting the survival, growth, and reproduction rates of various marine species. In industrial applications, high concentrations of ammonia can cause corrosion in pipes.



Specifications	HI3826 Ammonia (as $\text{NH}_3\text{-N}$ ) in saltwater
Type	colorimetric
Range	0.0-2.5 mg/L (ppm)
Smallest Increment	0.5 mg/L (ppm)
Method	Nessler
Number of Tests	25 avg.
<b>Ordering Information</b>	<b>HI3826</b> test kit comes with 20 mL plastic beaker, color comparison cube, 20 mL ammonia reagent 1 (for seawater) and 20 mL Nessler reagent.
<b>Reagent</b>	<b>HI3826-025</b> Ammonia (seawater) (as $\text{NH}_3\text{-N}$ ), 25 tests avg

HI38074

## Boron Test Kit

The HI38074 is a titration-based chemical test kit that determines the boron concentration in irrigation water within a 0 to 5 mg/L (ppm) range. The HI38074 is supplied with all of the necessary reagents and equipment to perform the analysis, including the HI98103 Checker pH meter. The HI 98103 Checker pH meter is used for sample preparation and for the determination of the pH titration endpoint. The HI38074 contains enough reagents for perform 100 tests.

### Complete setup

- All required materials are included with the test kit, such as the sample beaker, plastic pipettes, pH adjustment reagents, and pocket pH meter.
- **High resolution**
  - Readings from 0 to 5 mg/L are determined to 0.2 mg/L resolution.
- **Replacement reagents available**
  - There is no need to buy a new kit when reagents are exhausted. The HI38074-100 can be ordered to replace the reagents supplied with the kit.

### Significance of Use

Boron is one of the micronutrients essential for plant growth. It may be present naturally in water, or it may find its way into a watercourse through industrial waste effluents. Boron in excess of 2.0 mg/L in irrigation water can be detrimental to plant growth, and some plants may even be adversely affected by concentrations lower than 1.0 mg/L.

The United States Department of Agriculture (USDA) reports the following classification:

#### Boron (ppm) Effect on crops

- < 0.5 good (except for very sensitive crops)
- 0.5 to 2.0 some risks (many crops must be excluded)
- > 2.0 dangerous (may only be used for very tolerant crops)



Specifications	HI38074 Boron
Type	titration
Range	0.0-5.0 mg/L (ppm)
Smallest Increment	0.2 mg/L (ppm)
Method	boric acid
Number of Tests	100 avg.
<b>Ordering Information</b>	<b>HI38074</b> test kit comes with reagent for 100 tests, HI98103 Checker pocket pH meter, pH 4.01 (1 sachet), pH 7.01 (1 sachet), screwdriver, 120 mL bottle with cap, 50 mL calibrated vessel, and 1 mL plastic pipettes (2).
<b>Reagent</b>	<b>HI38074-100</b> Boron, 100 tests avg

HI3830

## Bromine Test Kit

The HI3830 is a colorimetric chemical test kit that determines the bromine concentration in samples within a 0.0 to 3.0 mg/L (ppm) Br<sub>2</sub> range. The HI3830 is supplied with all of the necessary reagents and equipment to perform the analysis. The test kit contains enough reagents for perform approximately 60 tests.

- **Complete setup**
  - All required materials are included with the test kit, such as the sample beaker, color comparison cube, and reagent dropper bottles.
- **High resolution**
  - Readings from 0.0 to 3.0 mg/L Br<sub>2</sub> are determined to 0.6 mg/L resolution.
- **Replacement reagents available**
  - There is no need to buy a new kit when reagents are exhausted. The HI3830-060 can be ordered to replace the reagents supplied with the kit.

### Significance of Use

Bromine is less volatile and more stable than chlorine, making it a good choice as a disinfectant in pools, spas, and hot tubs, and a sanitizing agent in drinking water systems. Like chlorine, excess amounts of bromine in water can be dangerous to health and can cause eye irritation. Daily monitoring of bromine concentration prevents damage to equipment and contributes to the optimization and efficiency of the process while providing for increased user safety.



Specifications	HI3830 Bromine (as Br <sub>2</sub> )
Type	colorimetric
Range	0.0-3.0 mg/L (ppm)
Smallest Increment	0.6 mg/L (ppm)
Method	DPD
Number of Tests	60 avg.
<b>Ordering Information</b>	<b>HI3830</b> test kit comes with 30 mL reagent 1, 20 mL reagent 2, color comparison cube, and plastic vessel.
<b>Reagent</b>	<b>HI3830-060</b> Bromine, 60 tests avg

HI3818

## Carbon Dioxide Test Kit

The HI3818 is a titration-based chemical test kit that determines the carbon dioxide concentration in three ranges: 0.0 to 10.0 mg/L CO<sub>2</sub>, 0.0 to 50.0 mg/L CO<sub>2</sub>, and 0 to 100 mg/L CO<sub>2</sub>. The HI3818 is supplied with all of the necessary reagents and equipment to perform the analysis. The test kit contains enough reagents for perform approximately 110 tests.

- **Complete setup**
  - All required materials are included with the test kit, such as two sample beakers, reagent dropper bottles, and calibrated syringe.
- **High resolution**
  - Readings from 0.0 to 10.0 mg/L CO<sub>2</sub> are determined to 0.1 mg/L resolution.
  - Readings from 0.0 to 50.0 mg/L CO<sub>2</sub> are determined to 0.5 mg/L resolution.
  - Readings from 0 to 100 mg/L CO<sub>2</sub> are determined to 1 mg/L resolution.
- **Replacement reagents available**
  - There is no need to buy a new kit when reagents are exhausted. The HI3818-100 can be ordered to replace the reagents supplied with the kit.

### Significance of Use

Lakes and rivers naturally contain carbon dioxide concentrations less than 10 mg/L. However, stagnant or polluted water can generate large amounts of carbon dioxide due to organic or mineral decomposition. Higher amounts of carbon dioxide can make the water corrosive and toxic to aquatic organisms. Monitoring carbon dioxide levels is also critical in the manmade environment. Carbon dioxide is added to drinking water during the final stages of the purification process. In water softening systems, a delicate balance of carbon dioxide must be maintained to prevent corrosion or encrustation of pipes and storage tanks.



Specifications	HI3818 Carbon Dioxide (as CO <sub>2</sub> )
Type	titration
Range	0.0-10.0 mg/L (ppm) 0.0-50.0 mg/L (ppm) 0-100 mg/L (ppm)
Smallest Increment	0.1 mg/L (ppm) 0.5 mg/L (ppm) 1 mg/L (ppm)
Method	phenolphthalein
Number of Tests	100 avg.
<b>Ordering Information</b>	<b>HI3818</b> test kit comes with 10 mL phenolphthalein indicator, 120 mL carbon dioxide reagent, 10 mL calibrated vessel, 50 mL calibrated vessel and calibrated syringe with tip.
<b>Reagent</b>	<b>HI3818-100</b> Carbon Dioxide, 110 tests avg

HI3815

## Chloride Test Kit

The HI3815 is a titration-based chemical test kit that determines the chloride concentration within two ranges: 0 to 100 mg/L Cl<sup>-</sup> and 0 to 1000 mg/L Cl<sup>-</sup>. The HI3815 is supplied with all of the necessary reagents and equipment to perform the analysis. The test kit contains enough reagents for perform approximately 110 tests.

- **Complete setup**
  - All required materials are included with the test kit, such as the sample beaker, indicator and reagent solutions, and calibrated syringe.
- **High resolution**
  - Readings from 0 to 100 mg/L are determined to 1 mg/L resolution.
  - Readings from 0 to 1000 mg/L are determined to 10 mg/L resolution.
- **Replacement reagents available**
  - There is no need to buy a new kit when reagents are exhausted. The HI3815-100 can be ordered to replace the reagents supplied with the kit.

### Significance of Use

Chloride ions are one of the major inorganic anions in water and wastewater. Although high concentrations of chloride in water are not known to be toxic to humans, its regulation is mainly due to taste. It is essential to monitor chloride concentration in boiler systems to prevent damage of metal parts. In high levels, chloride can corrode stainless steel and be toxic to plant life.



Specifications	HI3815 Chloride (as Cl <sup>-</sup> )
Type	titration
Range	0-100 mg/L (ppm) 0-1000 mg/L (ppm)
Smallest Increment	1 mg/L (ppm) 10 mg/L (ppm)
Method	mercuric nitrate
Number of Tests	110 avg.
<b>Ordering Information</b>	<b>HI3815</b> test kit comes with 15 mL diphenylcarbazone indicator, 30 mL nitric acid solution, 120 mL mercuric nitrate solution, 50 mL calibrated vessel, 10 mL calibrated vessel, calibrated syringe with tip.
<b>Reagent</b>	<b>HI3815-100</b> Chloride, 110 tests avg

HI3829F

## Free Chlorine Test Kit

With Color Cube

The HI3829F is a colorimetric chemical test kit that determines the free chlorine concentration within a 0.0 to 2.0 mg/L (ppm) range. The HI3829F is supplied with all of the necessary reagents and equipment to perform the analysis. The test kit contains enough reagents for perform approximately 50 tests.

- **Complete setup**
  - All required materials are included with the test kit, such as the sample beaker, color comparison cube, and reagent packets and dropper bottles.
- **High resolution**
  - Readings from 0.0 to 2.0 mg/L are determined to 0.5 mg/L resolution.
- **Replacement reagents available**
  - There is no need to buy a new kit when reagents are exhausted. The HI3829F-050 can be ordered to replace the reagents supplied with the kit.

### Significance of Use

Disinfection is a process of killing disease-causing organisms (or pathogens). Chlorine ( $\text{Cl}_2$ ) is a very desirable disinfectant because, when mixed with pure water, it reacts to form hypochlorous acid (HOCl) and hydrochloric acid (HCl). HOCl (free active chlorine) is the most effective form of chlorine for disinfection of pools, spas, and drinking water.

Drinking water municipalities add elemental chlorine to the water supply as chlorine gas, liquid sodium hypochlorite, or dry calcium hypochlorite. In water these form free chlorine ions, which destroy disease-causing pathogens, reduce odor, eliminate bacteria and help to remove unwanted elements. The USEPA requires that residual disinfectant is present in finished drinking water to ensure there is disinfectant available throughout the distribution system, with chlorine acting as one of the disinfectants that provides said residual.



Specifications	HI3829F Free Chlorine (as $\text{Cl}_2$ )
Type	colorimetric
Range	0.0 to 2.0 mg/L (ppm)
Smallest Increment	0.5 mg/L (ppm)
Method	DPD
Number of Tests	50 avg.
<b>Ordering Information</b>	<b>HI3829F</b> test kit comes with color comparison cube, 20 mL reagent 1 and 15 mL reagent 2
<b>Reagent</b>	<b>HI3829F-050</b> free chlorine, 50 tests avg.

HI3831F

## Free Chlorine Test Kit

With Color Cube

The HI3831F is a colorimetric chemical test kit that determines the free chlorine concentration within a 0.0 to 2.5 mg/L (ppm) range. The HI3831F is supplied with all of the necessary reagents and equipment to perform the analysis. The test kit contains enough reagents for perform approximately 50 tests.

- **Complete setup**
  - All required materials are included with the test kit, such as the sample beaker, color comparison cube, and reagent packets and dropper bottles.
- **High resolution**
  - Readings from 0.0 to 2.5 mg/L are determined to 0.5 mg/L resolution.
- **Replacement reagents available**
  - There is no need to buy a new kit when reagents are exhausted. The HI3831F-050 can be ordered to replace the reagents supplied with the kit.

### Significance of Use

Disinfection is a process of killing disease-causing organisms (or pathogens). Chlorine ( $\text{Cl}_2$ ) is a very desirable disinfectant because, when mixed with pure water, it reacts to form hypochlorous acid (HOCl) and hydrochloric acid (HCl). HOCl (free active chlorine) is the most effective form of chlorine for disinfection of pools, spas, and drinking water.

Drinking water municipalities add elemental chlorine to the water supply as chlorine gas, liquid sodium hypochlorite, or dry calcium hypochlorite. In water these form free chlorine ions, which destroy disease-causing pathogens, reduce odor, eliminate bacteria and help to remove unwanted elements. The USEPA requires that residual disinfectant is present in finished drinking water to ensure there is disinfectant available throughout the distribution system, with chlorine acting as one of the disinfectants that provides said residual. However, the EPA has also set a maximum contaminant level of 4.0 mg/L for free chlorine due to potential health effects above this level.



Specifications	HI3831F Free Chlorine (as $\text{Cl}_2$ )
Type	colorimetric
Range	0.0 to 2.5 mg/L (ppm)
Smallest Increment	0.5 mg/L (ppm)
Method	DPD
Number of Tests	50 avg.
<b>Ordering Information</b>	<b>HI3831F</b> test kit comes with color comparison cube, 20 mL reagent 1 and 15 mL reagent 2.
<b>Reagent</b>	<b>HI3831F-050</b> free chlorine, 50 tests avg.

HI3875

## Free Chlorine Test Kit

Medium Range with Checker® Disc

The HI3875 is a chemical test kit that determines the free chlorine concentration within a 0.0 to 3.5 mg/L (ppm) range. The HI3875 is supplied with all of the necessary reagents and equipment to perform the analysis, including the Checker® disc for accurate determination. The test kit contains enough reagents to perform approximately 100 tests.

### • Complete setup

- All required materials are included with the test kit, such as the glass vials, plastic pipette, reagent packets, and Checker® disc.

### • High resolution

- Readings from 0.0 to 3.5 mg/L are determined to 0.1 mg/L resolution.

### • Replacement reagents available

- There is no need to buy a new kit when reagents are exhausted. The HI3875-100 can be ordered to replace the reagents supplied with the kit.



## Significance of Use

Disinfection is a process of killing disease-causing organisms (or pathogens). Chlorine (Cl<sub>2</sub>) is a very desirable disinfectant because, when mixed with pure water, it reacts to form hypochlorous acid (HOCl) and hydrochloric acid (HCl). HOCl (free active chlorine) is the most effective form of chlorine for disinfection of pools, spas, and drinking water.

Drinking water municipalities add elemental chlorine to the water supply as chlorine gas, liquid sodium hypochlorite, or dry calcium hypochlorite. In water these form free chlorine ions, which destroy disease-causing pathogens, reduce odor, eliminate bacteria and help to remove unwanted elements. The USEPA requires that residual disinfectant is present in finished drinking water to ensure there is disinfectant available throughout the distribution system, with chlorine acting as one of the disinfectants that provides said residual. However, the EPA has also set a maximum contaminant level of 4.0 mg/L for free chlorine due to potential health effects above this level.

Specifications	HI3875 Free Chlorine (as Cl <sub>2</sub> )
Type	checker disc
Range	0.0-3.5 mg/L (ppm)
Smallest Increment	0.1 mg/L (ppm)
Method	DPD
Number of Tests	100 avg.
<b>Ordering Information</b>	<b>HI3875</b> test kit comes with HI93701-0 free Cl reagent (100 packets), 500 mL deionized water, checker disc, glass vials with caps (2) and 3 mL plastic pipette.
<b>Reagent</b>	<b>HI3875-100</b> free chlorine, 100 tests avg.

HI38018

## Free Chlorine Test Kit

Low and Medium Range with Checker® Disc

The HI38018 is a chemical test kit that determines the free chlorine concentration in two ranges: 0.00 to 0.70 mg/L and 0.0 to 3.5 mg/L. The HI38018 is supplied with all of the necessary reagents and equipment to perform the analysis, including the Checker® disc for accurate determination. The test kit contains enough reagents to perform approximately 200 tests.

### • Complete setup

- All required materials are included with the test kit, such as the glass vials, plastic pipette, reagent packets, and Checker® disc.

### • High resolution

- Readings from 0.00 to 0.70 mg/L are determined to 0.02 mg/L resolution.
- Readings from 0.0 to 3.5 mg/L are determined to 0.1 mg/L resolution.

### • Replacement reagents available

- There is no need to buy a new kit when reagents are exhausted. The HI38018-200 can be ordered to replace the reagents supplied with the kit.

## Significance of Use

Disinfection is a process of killing disease-causing organisms (or pathogens). Chlorine (Cl<sub>2</sub>) is a very desirable disinfectant because, when mixed with pure water, it reacts to form hypochlorous acid (HOCl) and hydrochloric acid (HCl). HOCl (free active chlorine) is the most effective form of chlorine for disinfection of pools, spas, and drinking water.

Drinking water municipalities add elemental chlorine to the water supply as chlorine gas, liquid sodium hypochlorite, or dry calcium hypochlorite. In water these form free chlorine ions, which destroy disease-causing pathogens, reduce odor, eliminate bacteria and help to remove unwanted elements. The USEPA requires that residual disinfectant is present in finished drinking water to ensure there is disinfectant available throughout the distribution system, with chlorine acting as one of the disinfectants that provides said residual. However, the EPA has also set a maximum contaminant level of 4.0 mg/L for free chlorine due to potential health effects above this level.



Specifications	HI38018 Free Chlorine (as Cl <sub>2</sub> )
Type	checker disc
Range	0.00-0.70 mg/L (ppm) 0.0-3.5 mg/L (ppm)
Smallest Increment	0.02 mg/L (ppm) 0.1 mg/L (ppm)
Method	DPD
Number of Tests	200 avg.
<b>Ordering Information</b>	<b>HI38018</b> test kit comes with HI93701-0 free chlorine reagent (200 packets), demineralizer bottle with cap for 12 L, checker disc, glass vials with caps (2) and 3 mL plastic pipettes.
<b>Reagent</b>	<b>HI38018-200</b> free chlorine, 200 tests avg.

HI38017

## Free & Total Chlorine Test Kit

Low and Medium Range with Checker® Disc

The HI38017 is a chemical test kit that determines the free and total chlorine concentration in two ranges: 0.00 to 0.70 mg/L and 0.0 to 3.5 mg/L. The HI38017 is supplied with all of the necessary reagents and equipment to perform both analyses, including the Checker® disc for accurate determination. The test kit contains enough reagents for perform approximately 200 tests.

- **Complete setup**
  - All required materials are included with the test kit, such as the glass vials, plastic pipette, reagent packets, and Checker® disc.
- **High resolution**
  - Readings from 0.00 to 0.70 mg/L are determined to 0.02 mg/L resolution.
  - Readings from 0.0 to 3.5 mg/L are determined to 0.1 mg/L resolution.
- **Replacement reagents available**
  - There is no need to buy a new kit when reagents are exhausted. The HI38017-200 can be ordered to replace the reagents supplied with the kit.

### Significance of Use

Chlorine is the most commonly used water disinfectant in applications such as drinking water and wastewater treatment, pool and spa sanitization, and food processing and sterilization. Chlorine present in water binds with bacteria, leaving only a part of the original quantity (free chlorine) to continue its disinfecting action. If the free chlorine level is improper with respect to pH, water will have an unpleasant taste and odor and the disinfecting potential of the chlorine will be diminished.

Free chlorine reacts with ammonium ions and organic compounds to form chlorine compounds; this results in diminished disinfecting capabilities compared with free chlorine. Chlorine compounds together with chloramines form combined chlorine. Combined chlorine and free chlorine together result in total chlorine. While free chlorine has a much higher disinfectant potential, combined chlorine has a much higher stability and lower volatility.



Specifications	HI38017 Free & Total Chlorine (as Cl <sub>2</sub> )
Type	checker disc
Range	0.00-0.70 mg/L (ppm) 0.0-3.5 mg/L (ppm)
Smallest Increment	0.02 mg/L (ppm) 0.1 mg/L (ppm)
Method	DPD
Number of Tests	200 avg.
<b>Ordering Information</b>	<b>HI38017</b> test kit comes with HI93701-0 free chlorine reagent (100 packets), HI93711-0 total chlorine reagent (100 packets), demineralizer bottle with filter cap for 12 L, checker disc, glass vials with caps (2) and 3 mL plastic pipettes
<b>Reagent</b>	<b>HI38017-200</b> free & total chlorine, 200 tests avg.

HI38020

## Free & Total Chlorine Test Kit

Low, Medium and High Range with Checker® Disc

The HI38020 is a chemical test kit that determines the free and total chlorine concentration in three ranges: 0.00 to 0.70 mg/L, 0.0 to 3.5 mg/L, and 0.0 to 10.0 mg/L. The HI38020 is supplied with all of the necessary reagents and equipment to perform both analyses, including the Checker® disc for accurate determination. The test kit contains enough reagents for perform approximately 200 tests.

- **Complete setup**
  - All required materials are included with the test kit, such as the glass vials, plastic pipette, reagent packets, and Checker® disc.
- **High resolution**
  - Readings from 0.00 to 0.70 mg/L are determined to 0.02 mg/L resolution.
  - Readings from 0.0 to 3.5 mg/L are determined to 0.1 mg/L resolution.
  - Readings from 0.0 to 10.0 mg/L are determined to 0.5 mg/L resolution.
- **Replacement reagents available**
  - There is no need to buy a new kit when reagents are exhausted. The HI38020-200 can be ordered to replace the reagents supplied with the kit.



### Significance of Use

Chlorine is the most commonly used water disinfectant in applications such as drinking water and wastewater treatment, pool and spa sanitization, and food processing and sterilization. Chlorine present in water binds with bacteria, leaving only a part of the original quantity (free chlorine) to continue its disinfecting action. If the free chlorine level is improper with respect to pH, water will have an unpleasant taste and odor and the disinfecting potential of the chlorine will be diminished.

Free chlorine reacts with ammonium ions and organic compounds to form chlorine compounds; this results in diminished disinfecting capabilities compared with free chlorine. Chlorine compounds together with chloramines form combined chlorine. Combined chlorine and free chlorine together result in total chlorine. While free chlorine has a much higher disinfectant potential, combined chlorine has a much higher stability and lower volatility.

Specifications	HI38020 Free & Total Chlorine (as Cl <sub>2</sub> )
Type	checker disc
Range	0.00-0.70 mg/L (ppm) 0.0-3.5 mg/L (ppm) 0.0-10.0 mg/L (ppm)
Smallest Increment	0.02 mg/L (ppm) 0.1 mg/L (ppm) 0.5 mg/L (ppm)
Method	DPD
Number of Tests	200 avg.
<b>Ordering Information</b>	<b>HI38020</b> test kit comes with HI93701-0 free chlorine reagent (100 packets), HI93711-0 total chlorine reagent (100 packets), demineralizer bottle with filter cap for 12 L, checker disc, glass vials with caps (2) and 3 mL plastic pipettes
<b>Reagent</b>	<b>HI38020-200</b> free & total chlorine, 200 tests avg.



HI3831T

## Total Chlorine Test Kit

with Color Cube

The HI3831T is a colorimetric chemical test kit that determines the total chlorine concentration within a 0.0 to 2.5 mg/L (ppm) range. The HI3831T is supplied with all of the necessary reagents and equipment to perform the analysis. The test kit contains enough reagents for perform approximately 50 tests.

- **Complete setup**
  - All required materials are included with the test kit, such as the sample beaker, color comparison cube, and reagent packets and dropper bottles.
- **High resolution**
  - Readings from 0.0 to 2.5 mg/L are determined to 0.5 mg/L resolution.
- **Replacement reagents available**
  - There is no need to buy a new kit when reagents are exhausted. The HI3831T-050 can be ordered to replace the reagents supplied with the kit.

### Significance of Use

The chlorination of water supplies and polluted waters is used mainly to destroy or deactivate disease-producing microorganisms. Chlorine also serves to improve the quality of drinking waters, as it reacts with ammonia, iron, manganese, sulfide, and some organic substances. Nevertheless, high amounts of chlorine will produce adverse effects like the formation of compounds which are potentially carcinogenic (e.g. chloroform) or harmful to aquatic life (e.g. chloramines). It remains essential to control the amount of added chlorine in order to fulfill the primary purpose of disinfecting while also minimizing any adverse effects.



Specifications	HI3831T Total Chlorine (as Cl <sub>2</sub> )
Type	colorimetric
Range	0.0-2.5 mg/L (ppm)
Smallest Increment	0.5 mg/L (ppm)
Method	DPD
Number of Tests	50 avg.
<b>Ordering Information</b>	<b>HI3831T</b> test kits comes with color comparison cube, 20 mL chlorine reagent 1, 15 mL chlorine reagent 2 and 15 mL chlorine reagent 3
<b>Reagent</b>	<b>HI3831T-050</b> total chlorine, 50 tests avg.

HI38023

## Total Chlorine Test Kit

Extended Range

The HI38023 is a titration-based chemical test kit that determines the total chlorine concentration within a 10 to 200 mg/L (ppm) range. The HI38023 is supplied with all of the necessary reagents and equipment to perform the analysis. The test kit contains enough reagents for perform approximately 100 tests.

- **Complete setup**
  - All required materials are included with the test kit, such as the sample beaker, indicator and reagent bottles and packets, spoon, and plastic syringe.
- **High resolution**
  - Readings from 10 to 200 mg/L are determined to 10 mg/L resolution.
- **Replacement reagents available**
  - There is no need to buy a new kit when reagents are exhausted. The HI38023-100 can be ordered to replace the reagents supplied with the kit.

### Significance of Use

The chlorination of water supplies and polluted waters is used mainly to destroy or deactivate disease-producing microorganisms. Chlorine also serves to improve the quality of drinking waters, as it reacts with ammonia, iron, manganese, sulfide, and some organic substances. Nevertheless, high amounts of chlorine will produce adverse effects like the formation of compounds which are potentially carcinogenic (e.g. chloroform) or harmful to aquatic life (e.g. chloramines). It remains essential to control the amount of added chlorine in order to fulfill the primary purpose of disinfecting while also minimizing any adverse effects.



Specifications	HI38023 Total Chlorine (as Cl <sub>2</sub> )
Type	titration
Range	10-200 mg/L (ppm)
Smallest Increment	10 mg/L (ppm)
Method	iodometric
Number of Tests	100 avg.
<b>Ordering Information</b>	<b>HI38023</b> test kit comes with 30 mL potassium iodide solution, sulfamic reagent (100 packets), 25 mL starch indicator, 100 mL thiosulfate reagent, 50 mL calibrated vessel, 1 mL syringe with tip, 1 mL plastic pipette and spoon.
<b>Reagent</b>	<b>HI38023-100</b> total chlorine extended range, 100 tests avg.

HI3846

## Chromium Test Kit

The HI3846 is a colorimetric chemical test kit that determines the chromium concentration in samples within a 0.0 to 1.0 mg/L (ppm) range as CrVI. The HI3846 is supplied with all of the necessary reagents and equipment to perform the analysis. The test kit contains enough reagents to perform approximately 100 tests.

- **Complete setup**
  - All required materials are included with the test kit, such as the color comparison cube and reagent packets.
- **High resolution**
  - Readings from 0.0 to 1.0 mg/L CrVI are determined to 0.2 mg/L resolution.
- **Replacement reagents available**
  - There is no need to buy a new kit when reagents are exhausted. The HI3846-100 can be ordered to replace the reagents supplied with the kit.

### Significance of Use

Chromium salts are widely used in industrial processes such as metal finishing and plating, as well as in the leather industry as a tanning agent, and in the manufacture of paints, dyes, explosives, and ceramics. Chromium may enter a water supply through the discharge of waste from these industries or from chromate-treated cooling waters, where it is frequently added for corrosion control. The hexavalent state of chromium, CrVI, is toxic to humans, animals, and aquatic life; it can produce lung tumors when inhaled and readily induces skin sensitization.

HI3847

## Copper Test Kit

The HI3847 is a colorimetric chemical test kit that determines the copper concentration in samples within a 0 to 2.5 mg/L (ppm) range. The HI3847 is supplied with all of the necessary reagents and equipment to perform the analysis. The test kit contains enough reagents to perform approximately 100 tests.

- **Complete setup**
  - All required materials are included with the test kit, such as the color comparison cube and reagent packets.
- **High resolution**
  - Readings from 0 to 2.5 mg/L are determined to 0.5 mg/L resolution.
- **Replacement reagents available**
  - There is no need to buy a new kit when reagents are exhausted. The HI3847-100 can be ordered to replace the reagents supplied with the kit.

### Significance of Use

Copper is an essential trace element in for plant metabolism as well as the human diet, with a daily requirement of around 2.0 mg. Due to its malleability, thermal and electrical conductivity, and corrosion resistance, copper is also used in a variety of industrial and technological applications. Copper may also be present in natural water and effluents due to widespread use to control biological growths in reservoirs and distribution pipes.



Specifications	HI3846 Chromium (as CrVI)
Type	colorimetric
Range	0.0-1.0 mg/L (ppm)
Smallest Increment	0.2 mg/L (ppm)
Method	diphenylcarbohydrazide
Number of Tests	100 avg.
<b>Ordering Information</b>	<b>HI3846</b> test kit comes with HI3846-0 reagent (100 packets) and color comparison cube.
<b>Reagent</b>	<b>HI3846-100</b> chromium VI, 100 tests avg.

Specifications	HI3847 Copper
Type	colorimetric
Range	0.0-2.5 mg/L (ppm)
Smallest Increment	0.5 mg/L (ppm)
Method	bicinchoninic acid
Number of Tests	100 avg.
<b>Ordering Information</b>	<b>HI3847</b> test kit comes with HI3847-0 reagent (100 packets) and color comparison cube.
<b>Reagent</b>	<b>HI3847-100</b> copper, 100 tests avg.

HI3838

## Formaldehyde Test Kit

The HI3838 is a titration-based chemical test kit that determines the formaldehyde concentration in two ranges: 0.00 to 1.00% and 0.0 to 10.0%. The HI3838 is supplied with all of the necessary reagents and equipment to perform the analysis. The test kit contains enough reagents to perform approximately 110 tests.

- **Complete setup**
  - All required materials are included with the test kit, such as the sample beaker, indicator and reagent bottles, and calibrated syringe.
- **High resolution**
  - Readings from 0.00 to 1.00% are determined to 0.01% resolution.
  - Readings from 0.00 to 10.0% are determined to 0.1% resolution.
- **Replacement reagents available**
  - There is no need to buy a new kit when reagents are exhausted. The HI3838-100 can be ordered to replace the reagents supplied with the kit.

### Significance of Use

Formaldehyde is an important organic compound used to make many materials and chemical compounds. Its role in many industries varies from holding dyes onto fabrics, to assisting in the electroplating of metals. Formaldehyde is also used in biological preservation, drug testing, and photograph development. Each application uses different levels of formaldehyde and requires monitoring to optimize its given purpose. Formaldehyde is also a large consideration for human health. Due to its widespread use, there are regulations in place for formaldehyde limits within workplaces to avoid overexposure.



Specifications	HI3838 Formaldehyde (as CH <sub>2</sub> O)
Type	titration
Range	0.0 to 1.0% Formaldehyde; 0 to 10% Formaldehyde
Smallest Increment	0.1% (0.0 to 1.0% range); 1% (0 to 10% range)
Method	sodium sulfite / hydrochloric acid
Number of Tests	110 avg.
<b>Ordering Information</b>	<b>HI3838</b> test kit comes with 15 mL Alizarin Yellow R indicator, 30 g sodium sulfite, 120 mL titrant solution, plastic spoon, plastic bottle, 10 mL calibrated vessel, demineralizer bottle with filter cap, calibrated titration syringe with tip and plungers.
<b>Reagent</b>	<b>HI3838-100</b> formaldehyde, 110 tests avg.

HI3859

## Glycol Yes/No Test Kit

Use the HI3859 glycol standard 0.025% included in the kit to easily recognize a positive result in the form of an intense purple color. Ethylene glycol and other glycols are determined by a two-step reaction:

**Step One:** Glycol is oxidized to two carbonyl groups under acidic conditions.

**Step Two:** The carbonyl groups react with the indicator to give a highly colored solution.

The test detects traces of glycol above 30 ppm.



Specifications	HI3859 Glycol
Type	visual
Range	present/absent
Smallest Increment	–
Method	oxidation of glycolic group
Number of Tests	25 avg.
<b>Ordering Information</b>	<b>HI3859</b> test kit comes with 125 mL glycol reagent A, 25 packets glycol reagent B, 25 packets glycol reagent C, 25 mL glycol standard 0.025%, 3 mL plastic pipette, 1 mL plastic pipettes (25), 10 mL glass vials with caps (2) and brush.
<b>Reagent</b>	<b>HI3859-025</b> glycol, 25 tests avg.

Pool  
Line



HI3890 • HI38904

## Total Hardness Control Kit

Hardness, or TH, gives the total concentration of calcium and magnesium salts on: 1°FH / 0.562°dH hardness corresponds to 10 mg/L (ppm) calcium carbonate.

The harder the water, the bigger the risk of calcium and magnesium salt deposits on the walls of pools and spas. On the other hand, water that is too soft can be corrosive.

	°FH	°dH
very soft	0–7	0–4
soft	7–15	4–8
slightly hard	15–25	8–14
medium hard	25–32	14–18
hard	32–42	18–23
very hard	>42	>23

The ideal TH for pool water is between 10 and 20°FH or 5 and 11°dH.

- **Complete setup**
  - All required materials are included with the test kit, such as the sample beaker, indicator and buffer.

Specifications	HI3890/HI38904 Total Hardness (*as CaCO <sub>3</sub> )
Type	titration
Range	0 - 80 TH **
Smallest Increment	1 TH **
Method	calmagite
Ordering Information	HI3890 and HI38904 test kits comes with 30 mL hardness buffer, 10 mL calmagite indicator and 50 mL plastic beaker with cap.

\*\*1 °TH = 1 °FH = 0,562 °dH = 0,7 °gH = 0,2 meq/l = 10 mg/l CaCO<sub>3</sub>



HI3812

## Total Hardness Test Kit

The HI3812 is a titration-based chemical test kit that determines the total hardness concentration in two ranges: 0.0 to 30.0 mg/L and 0 to 300 mg/L. The HI3812 is supplied with all of the necessary reagents and equipment to perform the analysis. The test kit contains enough reagents for perform approximately 100 tests.

- **Complete setup**
  - All required materials are included with the test kit, such as the sample beaker, indicator and reagent bottles, and plastic syringe.
- **High resolution**
  - Readings from 0.0 to 30.0 mg/L are determined to 0.3 mg/L resolution.
  - Readings from 0 to 300 mg/L are determined to 3 mg/L resolution.
- **Replacement reagents available**
  - There is no need to buy a new kit when reagents are exhausted. The HI3812-100 can be ordered to replace the reagents supplied with the kit.

Specifications	HI3812 Total Hardness (*as CaCO <sub>3</sub> )
Type	titration
Range	0.0-30.0 mg/L (ppm) 0-300 mg/L (ppm)
Smallest Increment	0.3 mg/L (ppm) 3 mg/L (ppm)
Method	EDTA
Number of Tests	100 avg.
Ordering Information	HI3812 test kit comes with 30 mL hardness buffer, 10 mL calmagite indicator, 120 mL EDTA solution, 20 mL plastic beaker with cap, 50 mL plastic beaker with cap and 1 mL syringe with tip.
Reagent	HI3812-100 total hardness (*as CaCO <sub>3</sub> ), 100 tests avg.



HI38033

## Total Hardness Test Kit

The HI38033 is a titration-based chemical test kit that determines the total hardness concentration within the 0 to 30 grains per gallon (gpg) range. The HI38033 is supplied with all of the necessary reagents and equipment to perform the analysis. The test kit contains enough reagents for perform approximately 100 tests.

- **Complete setup**
  - All required materials are included with the test kit, such as the sample beaker, plastic pipette, and reagent dropper bottles.
- **High resolution**
  - Readings from 0 to 30 gpg are determined to 1 gpg resolution.
- **Replacement reagents available**
  - There is no need to buy a new kit when reagents are exhausted. The HI38033-100 can be ordered to replace the reagents supplied with the kit.

Specifications	HI38033 Total Hardness (*as CaCO <sub>3</sub> )
Type	titration
Range	0-30 gpg
Smallest Increment	1 gpg
Method	EDTA
Number of Tests	100 avg.
Ordering Information	HI38033 test kit comes with 30 mL buffer solution, 10 mL calmagite indicator, 75 mL EDTA solution (2), 20 mL plastic beaker with cap and 1 mL plastic pipette.
Reagent	HI38033-100 total hardness (*as CaCO <sub>3</sub> ), 100 tests avg.

\*1 gpg = 17 ppm CaCO<sub>3</sub>



HI3840

## Total Hardness Test Kit

*Low Range*

The HI3840 is a titration-based chemical test kit that determines the total hardness concentration within the 0 to 150 mg/L range. The HI3840 is supplied with all of the necessary reagents and equipment to perform the analysis. The test kit contains enough reagents for perform approximately 50 tests.

- **Complete setup**
  - All required materials are included with the test kit, such as the sample beaker and reagent dropper bottle.
- **High resolution**
  - Readings from 0 to 150 mg/L are determined to 5 mg/L resolution.

### Significance of Use

Water hardness has traditionally been defined as the capacity of water to precipitate soap. The ionic species in the water causing the precipitation was later found to be primarily calcium and magnesium. Thus, water hardness is actually a quantitative measure of these ions in the water. It is also now known that certain other ion species, such as iron, zinc, and manganese contribute to the overall water hardness. The measure and subsequent control of water hardness is essential to prevent scaling and clogging in water pipes.

Specifications	HI3840 Total Hardness (*as CaCO <sub>3</sub> )
Type	titration
Range	0-150 mg/L (ppm)
Smallest Increment	5 mg/L (ppm)
Method	EDTA
Number of Tests	50 avg.
<b>Ordering Information</b>	<b>HI3840</b> test kit comes with 30 mL hardness LR reagent, 10 mL calmagite indicator, and 50 mL calibrated vessel.



HI3841

## Total Hardness Test Kit

*Medium Range*

The HI3841 is a titration-based chemical test kit that determines the total hardness concentration within the 40 to 500 mg/L range. The HI3841 is supplied with all of the necessary reagents and equipment to perform the analysis. The test kit contains enough reagents for perform approximately 50 tests.

- **Complete setup**
  - All required materials are included with the test kit, such as the sample beaker and reagent dropper bottle.
- **High resolution**
  - Readings from 40 to 500 mg/L are determined to 20 mg/L resolution.

### Significance of Use

Water hardness has traditionally been defined as the capacity of water to precipitate soap. The ionic species in the water causing the precipitation was later found to be primarily calcium and magnesium. Thus, water hardness is actually a quantitative measure of these ions in the water. It is also now known that certain other ion species, such as iron, zinc, and manganese contribute to the overall water hardness. The measure and subsequent control of water hardness is essential to prevent scaling and clogging in water pipes.

Specifications	HI3841 Total Hardness (*as CaCO <sub>3</sub> )
Type	titration
Range	40-500 mg/L (ppm)
Smallest Increment	20 mg/L (ppm)
Method	EDTA
Number of Tests	50 avg.
<b>Ordering Information</b>	<b>HI3841</b> test kit comes with 30 mL hardness MR reagent, 10 mL calmagite indicator, and 50 mL calibrated vessel.



HI3842

## Total Hardness Test Kit

*High Range*

The HI3842 is a titration-based chemical test kit that determines the total hardness concentration within the 400 to 3000 mg/L range. The HI3842 is supplied with all of the necessary reagents and equipment to perform the analysis. The test kit contains enough reagents for perform approximately 50 tests.

- **Complete setup**
  - All required materials are included with the test kit, such as the sample beaker and reagent dropper bottle.
- **High resolution**
  - Readings from 400 to 3000 mg/L are determined to 100 mg/L resolution.

### Significance of Use

Water hardness has traditionally been defined as the capacity of water to precipitate soap. The ionic species in the water causing the precipitation was later found to be primarily calcium and magnesium. Thus, water hardness is actually a quantitative measure of these ions in the water. It is also now known that certain other ion species, such as iron, zinc, and manganese contribute to the overall water hardness. The measure and subsequent control of water hardness is essential to prevent scaling and clogging in water pipes.

Specifications	HI3842 Total Hardness (*as CaCO <sub>3</sub> )
Type	titration
Range	400-3000 mg/L (ppm)
Smallest Increment	100 mg/L (ppm)
Method	EDTA
Number of Tests	50 avg.
<b>Ordering Information</b>	<b>HI3842</b> test kit comes with 30 mL hardness HR reagent, 10 mL calmagite indicator, and 50 mL calibrated vessel.

HI3844 · HI38444

## Hydrogen Peroxide Test Kit

The HI3844 and HI38444 (Pool Line) are titration-based chemical test kits that determine the hydrogen peroxide concentration in two ranges: 0.00 to 2.00 mg/L and 0.0 to 10.0 mg/L. These test kits are supplied with all of the necessary reagents and equipment to perform the analysis. The test kit contains enough reagents for perform approximately 100 tests.

- **Complete setup**
  - All required materials are included with the test kit, such as the sample beaker, indicator and reagent bottles, spoon, and plastic pipettes.
- **High resolution**
  - Readings from 0.00 to 2.00 mg/L are determined to 0.25 mg/L resolution.
  - Readings from 0.0 to 10.0 mg/L are determined to 1.0 mg/L resolution.
- **Replacement reagents available**
  - There is no need to buy a new kit when reagents are exhausted. The HI3844-100 can be ordered to replace the reagents supplied with the kits.



### Significance of Use

Hydrogen peroxide (H<sub>2</sub>O<sub>2</sub>) is widely used as a disinfectant and as a bleach for textiles, wood pulp, and hair, just to name a few. It is also used as a substitute for chlorine in water and sewage treatment. Most common commercial forms are aqueous solutions containing about 6, 12 and 30% hydrogen peroxide and are referred to as "20-volume," "40-volume," and "100-volume" respectively, referring to the value of oxygen liberated when the solution is boiled. The Hanna test kit can quickly and easily determine concentration in water up to 10 mg/L of hydrogen peroxide. This is due to the fact that it is not affected by stabilizers, which are sometimes added to commercial hydrogen peroxide solutions.

In both the HI3844 and HI38444 test kit, hydrogen peroxide reacts slowly with iodide in acid solution (Step 1); thus a 15 minute interval is required to allow the reaction to occur completely. The amount of iodine generated is equivalent to the hydrogen peroxide in the sample. The liberated iodine is then titrated with standard sodium thiosulfate solution that reduces the iodine back to iodide ions (Step 2).

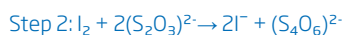

*Pool  
Line*

Specifications	HI3844 Hydrogen Peroxide (as H <sub>2</sub> O <sub>2</sub> )	HI38444 Hydrogen Peroxide (as H <sub>2</sub> O <sub>2</sub> )
Type	titration	
Range	0.00-2.00 mg/L (ppm); 0.0-10.0 mg/L (ppm)	
Smallest Increment	0.25 mg/L (ppm); 1.0 mg/L (ppm)	
Method	iodometric	
Number of Tests	100 avg.	
<b>Ordering Information</b>	<b>HI3844</b> and <b>HI38444</b> (Pool Line) test kits come with 100 mL hydrogen peroxide reagent A, 17 g hydrogen peroxide reagent B, 30 mL hydrogen peroxide reagent C, 25 mL hydrogen peroxide reagent D, graduated plastic test tube with cap, 50 mL calibrated plastic vessel, 3 mL plastic pipette, 1 mL plastic pipette and plastic spoon.	
<b>Reagent</b>	<b>HI3844-100</b> hydrogen peroxide, 100 tests avg.	

HI3843 · HI38434

## Bleach Test Kit

The HI3843 and HI38434 (Pool Line) are titration-based chemical test kits that determine the hypochlorite concentration within the 50 to 150 g/L Cl<sub>2</sub> range. These test kits are supplied with all of the necessary reagents and equipment to perform the analysis. The test kit contains enough reagents for perform approximately 100 tests.

- **Complete setup**
  - All required materials are included with the test kit, such as the Erlenmeyer flask, indicator and reagent bottles and packets, and plastic pipettes.
- **High resolution**
  - Readings from 50 to 150 g/L are determined to 5 g/L resolution.
- **Replacement reagents available**
  - There is no need to buy a new kit when reagents are exhausted. The HI3843-100 can be ordered to replace the reagents supplied with the kit.

### Significance of Use

Hypochlorites are common bleaching agents used to whiten textiles and paper and to disinfect solutions. Sodium hypochlorite solution has been traditionally used for the treatment of pool water since it is an inexpensive and readily available form of chlorine. The solution usually contains 10 to 15% available chlorine (equivalent to 100 to 150 g/L), but it rapidly loses its strength during storage. In addition, since it is greatly affected by heat, light, pH, and heavy metals, it needs to be monitored regularly.

An iodometric titration method is used in the HI3843 test kit. The hypochlorite solution is treated with potassium iodide and strongly acidified with acid (Step 1). The amount of iodine generated is equivalent to the chlorine in the sample. The concentration of iodine is then calculated by titration of thiosulfate ions that reduce the iodine back to iodide ions (Step 2).

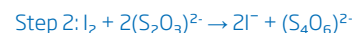
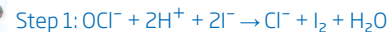

*Pool  
Line*

Specifications	HI3843 Hypochlorite (as Cl <sub>2</sub> )	HI38434 Hypochlorite (as Cl <sub>2</sub> )
Type	titration	
Range	50-150 g/L (ppt)	
Smallest Increment	5 g/L (ppt)	
Method	iodometric	
Number of Tests	100 avg.	
<b>Ordering Information</b>	<b>HI3843</b> and <b>HI38434</b> (Pool Line) test kits come with 30 mL potassium iodide solution, 100 packets bleach reagent B, 30 mL bleach reagent C (2), 125 mL glass Erlenmeyer flask and 1 mL plastic pipettes (25).	
<b>Reagent</b>	<b>HI3843-100</b> hypochlorite (bleach), 100 tests avg.	

\* 1 gpg = 17 ppm CaCO<sub>3</sub>

HI3834

## Iron Test Kit

Medium Range with Color Cube

The HI3834 is a colorimetric chemical test kit that determines the total iron concentration within a 0 to 5 mg/L (ppm) range. The HI3834 is supplied with all of the necessary reagents and equipment to perform the analysis. The test kit contains enough reagents for perform approximately 50 tests.

- **Complete setup**
  - All required materials are included with the test kit, such as the sample beaker, color comparison cube, and reagent packets.
- **High resolution**
  - Readings from 0 to 5 mg/L are determined to 1 mg/L resolution.
- **Replacement reagents available**
  - There is no need to buy a new kit when reagents are exhausted. The HI3834-050 can be ordered to replace the reagents supplied with the kit.

### Significance of Use

Iron is naturally present in water in low concentrations, but it reaches high concentrations in wastewater effluents. The iron concentration in water needs to be monitored because it becomes harmful above certain levels. In domestic water, for instance, iron can stain laundry, damage kitchenware, favor the growth of certain bacteria, and unpleasantly alter the taste of water. Iron is also an indicator of ongoing corrosion in water cooling and heating systems. Moreover, iron is normally monitored in mining wastewater to avoid contamination.



Specifications	HI3834 Iron (Fe <sup>2+</sup> & Fe <sup>3+</sup> )
Type	colorimetric
Range	0-5 mg/L (ppm)
Smallest Increment	1 mg/L (ppm)
Method	phenanthroline
Number of Tests	50 avg.
<b>Ordering Information</b>	<b>HI3834</b> test kit comes with 50 packets iron reagent, color comparison cube and 20 mL plastic vessel.
<b>Reagent</b>	<b>HI3834-050</b> iron, 50 tests avg.

HI38039

## Iron Test Kit

Low Range with Checker® Disc

The HI38039 is a colorimetric chemical test kit that determines the total iron concentration within a 0.00 to 1.00 mg/L (ppm) range. The HI38039 is supplied with all of the necessary reagents and equipment to perform the analysis. The test kit contains enough reagents for perform approximately 100 tests.

- **Complete setup**
  - All required materials are included with the test kit, such as the glass vials, plastic pipette, reagent packets, and Checker® disc.
- **High resolution**
  - Readings from 0.00 to 1.00 mg/L are determined to 0.02 mg/L resolution.
- **Replacement reagents available**
  - There is no need to buy a new kit when reagents are exhausted. The HI38039-100 can be ordered to replace the reagents supplied with the kit.

### Significance of Use

Iron is naturally present in water in low concentrations, but it reaches high concentrations in wastewater effluents. The iron concentration in water needs to be monitored because it becomes harmful above certain levels. In domestic water, for instance, iron can stain laundry, damage kitchenware, favor the growth of certain bacteria, and unpleasantly alter the taste of water. Iron is also an indicator of ongoing corrosion in water cooling and heating systems. Moreover, iron is normally monitored in mining wastewater to avoid contamination.



Specifications	HI38039 Iron (Fe <sup>2+</sup> & Fe <sup>3+</sup> )
Type	checker disc
Range	0.00-1.00 mg/L (ppm)
Smallest Increment	0.02 mg/L (ppm)
Method	phenanthroline
Number of Tests	100 avg.
<b>Ordering Information</b>	<b>HI38039</b> test kit comes with 100 packets iron reagent, checker disc, glass vials with caps (2) and 3 mL plastic pipette.
<b>Reagent</b>	<b>HI38039-100</b> iron LR, 100 tests avg.

HI38040

## Iron Test Kit

Medium Range with Checker® Disc

The HI38040 is a colorimetric chemical test kit that determines the total iron concentration within a 0.0 to 5.0 mg/L (ppm) range. The HI38040 is supplied with all of the necessary reagents and equipment to perform the analysis. The test kit contains enough reagents for perform approximately 100 tests.

- **Complete setup**
  - All required materials are included with the test kit, such as the glass vials, plastic pipette, reagent packets, and Checker® disc.
- **High resolution**
  - Readings from 0.0 to 5.0 mg/L are determined to 0.1 mg/L resolution.
- **Replacement reagents available**
  - There is no need to buy a new kit when reagents are exhausted. The HI38040-100 can be ordered to replace the reagents supplied with the kit.

### Significance of Use

Iron is naturally present in water in low concentrations, but it reaches high concentrations in wastewater effluents. The iron concentration in water needs to be monitored because it becomes harmful above certain levels. In domestic water, for instance, iron can stain laundry, damage kitchenware, favor the growth of certain bacteria, and unpleasantly alter the taste of water. Iron is also an indicator of ongoing corrosion in water cooling and heating systems. Moreover, iron is normally monitored in mining wastewater to avoid contamination.



Specifications	HI38040 Iron (Fe <sup>2+</sup> & Fe <sup>3+</sup> )
Type	checker disc
Range	0.0-5.0 mg/L (ppm)
Smallest Increment	0.1 mg/L (ppm)
Method	phenanthroline
Number of Tests	100 avg.
<b>Ordering Information</b>	<b>HI38040</b> test kit comes with 100 packets iron reagent, checker disc, glass vials with caps (2) and 3 mL plastic pipette.
<b>Reagent</b>	<b>HI38040-100</b> iron MR, 100 tests avg.

HI38041

## Iron Test Kit

High Range with Checker® Disc

The HI38041 is a colorimetric chemical test kit that determines the total iron concentration within a 0.0 to 10.0 mg/L (ppm) range. The HI38041 is supplied with all of the necessary reagents and equipment to perform the analysis. The test kit contains enough reagents for perform approximately 100 tests.

- **Complete setup**
  - All required materials are included with the test kit, such as the glass vials, plastic pipette, reagent packets, and Checker® disc.
- **High resolution**
  - Readings from 0.0 to 10.0 mg/L are determined to 0.2 mg/L resolution.
- **Replacement reagents available**
  - There is no need to buy a new kit when reagents are exhausted. The HI38041-100 can be ordered to replace the reagents supplied with the kit.

### Significance of Use

Iron is naturally present in water in low concentrations, but it reaches high concentrations in wastewater effluents. The iron concentration in water needs to be monitored because it becomes harmful above certain levels. In domestic water, for instance, iron can stain laundry, damage kitchenware, favor the growth of certain bacteria, and unpleasantly alter the taste of water. Iron is also an indicator of ongoing corrosion in water cooling and heating systems. Moreover, iron is normally monitored in mining wastewater to avoid contamination.



Specifications	HI38041 Iron (Fe <sup>2+</sup> & Fe <sup>3+</sup> )
Type	checker disc
Range	0.0-10.0 mg/L (ppm)
Smallest Increment	0.2 mg/L (ppm)
Method	phenanthroline
Number of Tests	100 avg.
<b>Ordering Information</b>	<b>HI38041</b> test kit comes with 100 packets iron reagent, 500 mL deionized water, checker disc, glass vials with caps (2), 3 mL plastic pipettes and long plastic pipette.
<b>Reagent</b>	<b>HI38041-100</b> iron HR, 100 tests avg.



HI3874

## Nitrate Test Kit

The HI3874 is a colorimetric chemical test kit that determines the nitrate concentration in samples within a 0 to 50 mg/L (ppm) range as nitrate-nitrogen ( $\text{NO}_3^-$ -N). The HI3874 is supplied with all of the necessary reagents and equipment to perform the analysis. The test kit contains enough reagents to perform approximately 100 tests.

- **Complete setup**
  - All required materials are included with the test kit, such as the glass cuvette, color comparison cube, and reagent packets.
- **High resolution**
  - Readings from 0 to 50 mg/L are determined to 10 mg/L resolution.
- **Replacement reagents available**
  - There is no need to buy a new kit when reagents are exhausted. The HI3874-100 can be ordered to replace the reagents supplied with the kit.

### Significance of Use

Nitrogen is abundant in the Earth's atmosphere and is present in water in the form of nitrate, nitrite, and ammonia. Plants use nitrogen as a nutrient to build proteins by tracking it in through their root system. Nitrate is formed in water mainly through rainfall, decomposition of organic matter, and runoff from manmade pollutants such as sewage waste and fertilizers. Almost all surface waters have a measurable level of nitrate, and a moderate amount is considered beneficial. Large amounts of nitrate, however, can lead to eutrophication which may result in decreased levels of dissolved oxygen in the water.



Specifications	HI3874 Nitrate (as $\text{NO}_3^-$ -N)
Type	colorimetric
Range	0-50 mg/L (ppm)
Smallest Increment	10 mg/L (ppm)
Method	cadmium reduction
Number of Tests	100 avg.
<b>Ordering Information</b>	<b>HI3874</b> test kit comes with 100 packets nitrate reagent, glass cuvette and color comparison cube.
<b>Reagent</b>	<b>HI3874-100</b> nitrate (as $\text{NO}_3^-$ -N), 100 tests avg.

HI38050

## Nitrate Test Kit

for Soil and Irrigation Water

The Hanna HI38050 nitrate test kit for soil and irrigation water makes it possible to determine the need for nitrogen fertilization. It also obtains the best crop response and avoids over-fertilization.

Nitrate is reduced to nitrite in the presence of cadmium. The nitrite thus produced reacts with the reagent to yield an orange compound. The amount of color developed is proportional to the concentration of nitrate present in the aqueous sample.

The Hanna nitrate-nitrogen test can be performed the whole year round, but testing is particularly recommended during spring and late spring, when rainfall and temperature-related bursts of microbiological activity often have great influence on the availability of nitrate-nitrogen.



Specifications	HI38050 Nitrate (as $\text{NO}_3^-$ -N) in irrigation water and soil
Type	checker disc
Range	water: 0-50 mg/L (ppm) soil: 0-60 mg/L (ppm)
Smallest Increment	water: 1 mg/L (ppm) soil: 2 mg/L (ppm)
Method	cadmium reduction
Number of Tests	water: 100 avg. soil: 100 avg.
<b>Ordering Information</b>	<b>HI38050</b> test kit comes with 200 packets nitrogen reagent, checker disc, glass vials with caps (2), 10 g calcium sulfate, demineralizer bottle with filter cap for 12 L, soil sieve, 50 mL plastic test tube with screw cap, large funnel, 100 paper filter discs, brush, 50 mL calibrated vessels (2), 2 g sample cup, 3 mL plastic pipette and spoons (2).
<b>Reagent</b>	<b>HI38050-200</b> nitrate, soil and irrigation (as $\text{NO}_3^-$ -N), 200 tests avg.

HI3873

## Nitrite Test Kit

The HI3873 is a colorimetric chemical test kit that determines the nitrite concentration in samples within a 0.0 to 1.0 mg/L (ppm) range as nitrite-nitrogen ( $\text{NO}_2^-$ -N). The HI3873 is supplied with all of the necessary reagents and equipment to perform the analysis. The test kit contains enough reagents to perform approximately 100 tests.

- **Complete setup**
  - All required materials are included with the test kit, such as the glass cuvette, color comparison cube, and reagent packets.
- **High resolution**
  - Readings from 0.0 to 1.0 mg/L are determined to 0.2 mg/L resolution.
- **Replacement reagents available**
  - There is no need to buy a new kit when reagents are exhausted. The HI3873-100 can be ordered to replace the reagents supplied with the kit.

### Significance of Use

Nitrites can be harmful to aquatic organisms even in low concentrations and for this reason, they are closely monitored in aquaculture facilities. In cooling towers, however, an adequate amount of nitrites is necessary to prevent corrosion. In high concentrations, they can be harmful to the environment and to humans. They are, therefore, normally monitored to verify the quality of water for domestic use, as well as lakes and ponds.

Nitrites are an intermediate product in the nitrogen cycle and are produced by ammonia oxidation with water, or even originate in industrial waste directly. They must not be present in drinking water.



Specifications	HI3873 Nitrite (as $\text{NO}_2^-$ -N)
Type	colorimetric
Range	0.0-1.0 mg/L (ppm)
Smallest Increment	0.2 mg/L (ppm)
Method	chromotropic acid
Number of Tests	100 avg.
<b>Ordering Information</b>	<b>HI3873</b> test kit comes with 100 packets nitrite reagent, glass cuvette and color comparison cube.
<b>Reagent</b>	<b>HI3873-100</b> nitrite (as $\text{NO}_2^-$ -N), 100 tests avg.

HI3810

## Dissolved Oxygen Test Kit



The HI3810 is a titration-based chemical test kit that determines the dissolved oxygen concentration within the 0 to 10 mg/L  $\text{O}_2$  range. The HI3810 is supplied with all of the necessary reagents and equipment to perform the analysis. The test kit contains enough reagents to perform approximately 110 tests.

- **Complete setup**
  - All required materials are included with the test kit, such as the glass stoppered bottle, indicator and reagent bottles, and calibrated syringe.
- **High resolution**
  - Readings from 0 to 10 mg/L are determined to 0.1 mg/L resolution.
- **Replacement reagents available**
  - There is no need to buy a new kit when reagents are exhausted. The HI3810-100 can be ordered to replace the reagents supplied with the kit.

### Significance of Use

The concentration of dissolved oxygen in water is extremely important in nature as well in man's environment. In oceans, lakes, rivers, and other surface water bodies, dissolved oxygen is essential to the growth and development of aquatic life. Without oxygen, water can become toxic due to the anaerobic decaying of organic matter. In man's environment, water must contain at least 2 mg/L of oxygen to protect water pipes from corrosion. However, boiler system water, in many cases, cannot contain greater than 10 mg/L oxygen.

A modified Winkler method is used in the HI3810 test kit. Manganous ions react with oxygen in the presence of potassium hydroxide to form a manganese oxide precipitate (Step 1). An azide is present to prevent any nitrite ions from interfering with the test. With addition of acid, manganese oxide hydroxide oxidizes the iodide to iodine (Step 2). Since the amount of iodine generated is equivalent to the oxygen in the sample, the concentration of iodine is calculated by titration of thiosulfate ions that reduce the iodine back to iodide ions (Step 3).



Specifications	HI3810 Dissolved Oxygen
Type	titration
Range	0.0-10.0 mg/L (ppm)
Smallest Increment	0.1 mg/L (ppm)
Method	modified Winkler
Number of Tests	110 avg.
<b>Ordering Information</b>	<b>HI3810</b> test kit comes with 30 mL manganous sulfate solution, 30 mL alkali-azide reagent, 30 mL sulfuric acid solution (2), 10 mL starch indicator, 120 mL titrant solution, glass bottle with stopper, 10 mL calibrated vessel and calibrated syringe with tip.
<b>Reagent</b>	<b>HI3810-100</b> dissolved oxygen, 100 tests avg.

HI38054

## Ozone Test Kit

The HI38054 is a chemical test kit that determines the ozone concentration in samples within the 0.0 to 2.3 mg/L range. The HI38054 is supplied with all of the necessary reagents and equipment to perform both analyses, including the Checker® disc for accurate determination. The test kit contains enough reagents to perform approximately 100 tests.

- **Complete setup**
  - All required materials are included with the test kit, such as the glass vials, plastic pipette, reagent packets, and Checker® disc.
- **High resolution**
  - Readings from 0.0 to 2.3 mg/L are determined to 0.1 mg/L resolution.
- **Replacement reagents available**
  - There is no need to buy a new kit when reagents are exhausted. The HI38054-100 can be ordered to replace the reagents supplied with the kit.

### Significance of Use

Ozone is an oxidizing agent used in many industrial and consumer applications. In drinking water, ozone is used for manganese removal, forming a precipitate that can be filtered out in the purification process. Additional organic matter present in drinking water that is responsible for producing odor and color can also be removed by ozone. Ozone also acts as a germicide and is used to manufacture pharmaceuticals, as a deodorizer, and bleaching agent.



Specifications	HI38054 Ozone
Type	checker disc
Range	0.0-2.3 mg/L (ppm)
Smallest Increment	0.1 mg/L (ppm)
Method	DPD
Number of Tests	100 avg.
<b>Ordering Information</b>	<b>HI38054</b> test kit comes with 100 packets ozone reagent, 500 mL deionized water, checker disc, glass vials with caps (2) and 3 mL plastic pipette.
<b>Reagent</b>	<b>HI38054-100</b> ozone, 100 tests avg.

HI3833

## Phosphate Test Kits

with Color Cube

The HI3833 is a colorimetric chemical test kit that determines the phosphate concentration in samples within a 0 to 5 mg/L (ppm) range. The HI3833 is supplied with all of the necessary reagents and equipment to perform the analysis. The test kit contains enough reagents to perform approximately 50 tests.

- **Complete setup**
  - All required materials are included with the test kit, such as the sample beaker, color comparison cube, and reagent packets.
- **High resolution**
  - Readings from 0 to 5 mg/L are determined to 1 mg/L resolution.
- **Replacement reagents available**
  - There is no need to buy a new kit when reagents are exhausted. The HI3833-050 can be ordered to replace the reagents supplied with the kit.

### Significance of Use

Phosphates are present in a number of products that are used by humans everyday. Some examples of the effects of phosphates are enhancing the flavor and tartness of cola drinks, as a buffering agent in controlling pH in antifreeze and delaying darkening of cut potatoes used in making french fries. Phosphates are also extensively used in detergents and cleaning fluids because of their ability to soften water and remove soil deposits.

Phosphates are particularly important for the growth and development of plant roots, and hence are one of the most common fertilizers used in agriculture. However, high concentrations of phosphates in agricultural runoff can cause environmental pollution, as they are a primary cause of eutrophication. Local laws govern the use of phosphates and the discharge levels into streams.



Specifications	HI3833 Phosphate (as PO <sub>4</sub> <sup>3-</sup> )
Type	colorimetric
Range	0-5 mg/L (ppm)
Smallest Increment	1 mg/L (ppm)
Method	ascorbic acid
Number of Tests	50 avg.
<b>Ordering Information</b>	<b>HI3833</b> test kit comes with 20 mL plastic beaker, color comparison cube and 50 packets phosphate reagent.
<b>Reagent</b>	<b>HI3833-050</b> phosphate, 50 tests avg.

HI38061

## Phosphate Test Kits

with Checker® Disc

The HI38061 is a chemical test kit that determines the phosphate concentration in three ranges: 0.00 to 1.00 mg/L, 0.0 to 5.0 mg/L, and 0 to 50 mg/L. The HI38061 is supplied with all of the necessary reagents and equipment to perform the analysis. The test kit contains enough reagents for perform approximately 100 tests.

- **Complete setup**
  - All required materials are included with the test kit, such as the glass vials, plastic pipette, reagent packets, and Checker® disc.
- **High resolution**
  - Readings from 0.00 to 1.00 mg/L are determined to 0.02 mg/L resolution.
  - Readings from 0.0 to 5.0 mg/L are determined to 0.1 mg/L resolution.
  - Readings from 0 to 50 mg/L are determined to 1 mg/L resolution.
- **Replacement reagents available**
  - There is no need to buy a new kit when reagents are exhausted. The HI38061-100 can be ordered to replace the reagents supplied with the kit.

### Significance of Use

Phosphates are present in a number of products that are used by humans everyday. Some examples of the effects of phosphates are enhancing the flavor and tartness of cola drinks, as a buffering agent in controlling pH in antifreeze and delaying darkening of cut potatoes used in making french fries. Phosphates are also extensively used in detergents and cleaning fluids because of their ability to soften water and remove soil deposits.

Phosphates are particularly important for the growth and development of plant roots, and hence are one of the most common fertilizers used in agriculture. However, high concentrations of phosphates in agricultural runoff can cause environmental pollution, as they are a primary cause of eutrophication. Local laws govern the use of phosphates and the discharge levels into streams.

Specifications	HI38061 Phosphate (as PO <sub>4</sub> <sup>3-</sup> )
Type	checker disc
Range	0.00-1.00 mg/L (ppm) 0.0-5.0 mg/L (ppm) 0-50 mg/L (ppm)
Smallest Increment	0.02 mg/L (ppm) 0.1 mg/L (ppm) 1 mg/L (ppm)
Method	ascorbic acid
Number of Tests	100 avg.
<b>Ordering Information</b>	<b>HI38061</b> test kit comes with 100 packets phosphate reagent, 500 mL deionized water, checker disc, glass vials with caps (2), 1 mL syringe with tip, 3 mL plastic pipette and long plastic pipette.
<b>Reagent</b>	<b>HI38061-100</b> phosphate, 100 tests avg.

HI3835

## Salinity Test Kit

The HI3835 is a titration-based chemical test kit that measures salinity within the 0.0 to 40.0 g/kg range. The HI3835 is supplied with all of the necessary reagents and equipment to perform the analysis. The test kit contains enough reagents for perform approximately 110 tests.

- **Complete setup**
  - All required materials are included with the test kit, such as the sample vial, indicator and reagent bottles, and calibrated syringe.
- **High resolution**
  - Readings from 0.0 to 40.0 g/kg are determined to 0.4 g/kg resolution.
- **Replacement reagents available**
  - There is no need to buy a new kit when reagents are exhausted. The HI3835-100 can be ordered to replace the reagents supplied with the kit.

### Significance of Use

Salinity is defined as the total solids in water after all carbonates have been converted to oxides, all bromide and iodide have been replaced by chloride, and all organic matter has been oxidized. The salinity value is in g/kg or ppt (parts per thousand). The monitoring of salinity is essential for industrial waste and seawater, as different species of plants and animals thrive varying salinity levels.



Specifications	HI3835 Salinity
Type	titration
Range	0 to 40 g/kg (ppt)
Smallest Increment	4 g/kg for each 0.1 ml of titrant
Method	mercuric nitrate
Number of Tests	110 avg.
<b>Ordering Information</b>	<b>HI3835</b> test kit comes with 15 mL diphenylcarbazone indicator, 30 mL nitric acid solution, 120 mL titrant solution, plastic vial with cap and 1 mL calibrated syringe with tip.
<b>Reagent</b>	<b>HI3835-100</b> salinity, 100 tests avg.

HI38067

## Silica Test Kit

### High Range

The HI38067 is a chemical test kit that determines the silica concentration in two ranges: 0 to 40 mg/L and 0 to 800 mg/L. The HI38067 is supplied with all of the necessary reagents and equipment to perform the analysis. The test kit contains enough reagents for perform approximately 100 tests.

- **Complete setup**
  - All required materials are included with the test kit, such as the glass vials, plastic pipette, reagent bottles and packets, and Checker® disc.
- **High resolution**
  - Readings from 0 to 40 mg/L are determined to 1 mg/L resolution.
  - Readings from 0 to 800 mg/L are determined to 40 mg/L resolution.
- **Replacement reagents available**
  - There is no need to buy a new kit when reagents are exhausted. The HI38067-100 can be ordered to replace the reagents supplied with the kit.

### Significance of Use

Silica is found in all natural waters in the dissolved mineral form. Silica is only slightly soluble in water and can be found as ionic silica, silicates, or colloidal or suspended particles. The solubility of silica is highly dependent on pH, temperature and pressure. Silica's presence in industrial applications, particularly high pressure turbines, is undesirable because of the scaling caused by the elevated temperature and pressure. Heating systems and reverse osmosis plants also require monitoring of silica to ensure process efficiency.



Specifications	HI38067 Silica (as SiO <sub>2</sub> )
Type	checker disc
Range	0-40 mg/L (ppm) 0-800 mg/L (ppm)
Smallest Increment	1 mg/L (ppm) 40 mg/L (ppm)
Method	heteropoly blue
Number of Tests	100 avg.
<b>Ordering Information</b>	<b>HI38067</b> test kit comes with 27 mL silica reagent A, 100 packets silica reagent B, 100 packets silica reagent C, demineralizer bottle with filter cap for 12 L, checker disc, glass vials with caps (2), 3 mL plastic pipette and 1 mL syringe with tip.
<b>Reagent</b>	<b>HI38067-100</b> silica HR (as SiO <sub>2</sub> ), 100 tests avg.

HI38000

## Sulfate Test Kits

The HI38000 is a chemical test kit that determines the sulfate concentration in two ranges: 20 to 30 mg/L and 30 to 100 mg/L. The HI38000 is supplied with all of the necessary reagents and equipment to perform the analysis. The test kit contains enough reagents for perform approximately 100 tests.

- **Complete setup**
  - All required materials are included with the test kit, such as the glass test tube, plastic pipette, spoon, and reagent bottles and packets.
- **High resolution**
  - Readings from 20 to 30 mg/L are determined to 5 mg/L resolution.
  - Readings from 30 to 100 mg/L are determined to 10 mg/L resolution.
- **Replacement reagents available**
  - There is no need to buy a new kit when reagents are exhausted. The HI38000-10 can be ordered to replace the reagents supplied with the kit.

### Significance of Use

Sulfate is widely present within natural waters in different concentrations. Sulfate concentration is to be kept within a strict range for drinking water, especially since this value can be high near mine drainage points. Sulfate is also rigorously tested in the production of beverages such as beer, due to its significant effect upon odor and taste.



Specifications	HI38000 Sulfate (as SO <sub>4</sub> <sup>2-</sup> )
Type	turbidimetric
Range	20-30 mg/L (ppm) 30-100 mg/L (ppm)
Smallest Increment	5 mg/L (ppm) 10 mg/L (ppm)
Method	barium chloride
Number of Tests	100 avg.
<b>Ordering Information</b>	<b>HI38000</b> test kit comes with 100 packets sulfate reagent A, 53 g sulfate reagent B, 10 mL complexing agent, 50 mL glass test tube, 50 mL plastic vessel, 3 mL plastic pipette and spoon.
<b>Reagent</b>	<b>HI38000-10</b> sulfate, 100 tests avg.

HI38001

## Sulfate Test Kits

### Low and High Range

The HI38001 is a chemical test kit that determines the sulfate concentration in two ranges: 100 to 1000 mg/L and 1000 to 10000 mg/L. The HI38001 is supplied with all of the necessary reagents and equipment to perform the analysis. The test kit contains enough reagents for perform approximately 200 tests.

- **Complete setup**
  - All required materials are included with the test kit, such as the sample beakers, syringes, and reagent bottles and packets.
- **High resolution**
  - Readings from 100 to 1000 mg/L are determined to 10 mg/L resolution.
  - Readings from 1000 to 10000 mg/L are determined to 100 mg/L resolution.
- **Replacement reagents available**
  - There is no need to buy a new kit when reagents are exhausted. The HI38000-10 can be ordered to replace the reagents supplied with the kit.

### Significance of Use

Sulfate is widely present within natural waters in different concentrations. Sulfate concentration is to be kept within a strict range for drinking water, especially since this value can be high near mine drainage points. Sulfate is also rigorously tested in the production of beverages such as beer, due to its significant effect upon odor and taste.



Specifications	HI38001 Sulfate (as $\text{SO}_4^{2-}$ )
Type	titration
Range	100-1000 mg/L (ppm) 1000-10000 mg/L (ppm)
Smallest Increment	10 mg/L (ppm) 100 mg/L (ppm)
Method	barium chloride
Number of Tests	200 avg.
<b>Ordering Information</b>	<b>HI38001</b> test kit comes with 100 packets sulfate reagent A (2 sets), 100 mL LR sulfate reagent B, 100 mL HR sulfate reagent B, 10 mL sulfate reagent C, 20 mL complexing agent, 30 mL sulfate solution, 50 mL plastic vessels (2) and 1 mL syringes (2).
<b>Reagent</b>	<b>HI38001-10</b> sulfate LR/HR, 100 tests avg.

HI3822

## Sulfite Test Kit

The HI3822 is a chemical test kit that determines the sulfite concentration in two ranges: 0 to 20 mg/L and 0 to 200 mg/L  $\text{Na}_2\text{SO}_3$ . The HI3822 is supplied with all of the necessary reagents and equipment to perform the analysis. The test kit contains enough reagents for perform approximately 110 tests.

- **Complete setup**
  - All required materials are included with the test kit, such as the sample beakers, indicator and reagent bottles, and calibrated syringe.
- **High resolution**
  - Readings from 0 to 20 mg/L are determined to 0.2 mg/L resolution.
  - Readings from 0 to 200 mg/L are determined to 2 mg/L resolution.
- **Replacement reagents available**
  - There is no need to buy a new kit when reagents are exhausted. The HI3822-100 can be ordered to replace the reagents supplied with the kit.

### Significance of Use

There are many reasons to monitor the concentration of sulfite in water. In boiler feed and effluent waters, a sulfite concentration of approximately 20 mg/L must be maintained to prevent pitting and oxidation of metal components. A high level of sulfite results in a lowered pH, thus promoting corrosion. The monitoring of sulfite is important in environmental control as well. Sulfite ions are toxic to aquatic lifeforms; the chemical demand that sulfide produces on oxygen in water can destroy the delicate ecological balance of lakes, rivers and ponds.



Specifications	HI3822 Sulfite (as $\text{Na}_2\text{SO}_3$ )
Type	titration
Range	0.0-20.0 mg/L (ppm) 0-200 mg/L (ppm)
Smallest Increment	0.2 mg/L (ppm) 2 mg/L (ppm)
Method	iodometric
Number of Tests	110 avg.
<b>Ordering Information</b>	<b>HI3822</b> test kit comes with 30 mL sulfamic acid solution, 30 mL EDTA reagent, 15 mL sulfuric acid solution, 10 mL starch indicator, 120 mL titrant solution, 20 mL calibrated vessel, 50 mL calibrated vessel and calibrated syringe with tip.
<b>Reagent</b>	<b>HI3822-100</b> sulfite (as $\text{Na}_2\text{SO}_3$ ), 110 tests avg.

## Hanna Soil Test Kit

The chemical composition of soil includes pH and chemical elements. Soil analysis is necessary for better management of fertilization and to know the residues of fertilizers in relation to the crop, tillage and the most suitable plant choice for soil composition. An analysis can highlight shortages and help the understanding of the causes of an abnormal growth. By using the Hanna soil test, it is possible to measure pH and the most important elements for plant growth: nitrogen (N), phosphorus (P) and potassium (K).

Testing the soil during each crop cycle and comparing the results with plant growth can be a useful information for subsequent cultivations.



Specifications	HI3896 Professional Agriculture Test Kit				
Test	Type	Range	Smallest Increment	Method	Number of Tests
Nitrogen	colorimetric	traces, low, medium, high	–	Ned	25 avg.
Phosphorus	colorimetric	traces, low, medium, high	–	ascorbic acid	25 avg.
pH	colorimetric	4 to 9 pH; 1 pH	–	pH indicator	25 avg.
Potassium	turbidimetric	traces, low, medium, high	–	tetraphenyl-borate	25 avg.
<b>Ordering Information</b>	<b>HI3896</b> test kit includes 120 mL extraction solution (2), 70 mL pH indicator, 75 powder packets (25 each for N, P & K), 1 mL pipettes (3), test tubes (5), test tube stand, spoon, brush, color cards (4), graduated card and handbook.				
<b>Reagents</b>	<b>HI3896-025</b> nitrogen, phosphorus, potassium and pH, 25 tests each				

## Quick Soil Test Kit

Hanna's quick soil test kit provides growers with an economical way to quickly test pH as well as the three basic elements needed for a healthier plant: nitrogen (N), phosphorus (P) and potassium (K).



Specifications	HI3895 Basic Agriculture Test Kit				
Test	Type	Range	Smallest Increment	Method	Number of Tests
Nitrogen	colorimetric	traces, low, medium, high	–	Ned	10 avg.
Phosphorus	colorimetric	traces, low, medium, high	–	ascorbic acid	10 avg.
pH	colorimetric	4 to 9 pH; 1 pH	–	pH indicator	10 avg.
Potassium	turbidimetric	traces, low, medium, high	–	tetraphenyl-borate	10 avg.
<b>Ordering Information</b>	<b>HI3895</b> test kit includes 40 powder packets (10 each for pH, N, P & K), 1 mL plastic pipette, test tubes (4), color cards (4) and one graduated card.				
<b>Reagents</b>	<b>HI3895-010</b> nitrogen, phosphorus, potassium and pH, 10 tests each				

HI3827

## Boiler & Feedwater Test Kit

The HI3827 is a chemical test kit that determines that uses titration, colorimetry, and direct measurement to measure six parameters common to boilers and feedwater testing: alkalinity, chloride, hardness, phosphate, pH, and sulfite. The HI3827 is supplied with all of the necessary reagents and equipment to perform each analysis, and all reagents are individually available as they run out.

- **Complete setup**
  - All required materials are included with the test kit, such as the pH tester, sample beaker, indicator and reagent bottles and packets, and color comparison cube.
- **High resolution**
  - All tests provide a high resolution based on the expected range of measurement.
- **Replacement reagents available**
  - There is no need to buy a new kit when reagents are exhausted. The reagents for each parameter can be ordered individually.



### Significance of Use

Monitoring the alkalinity, chloride, hardness, phosphate, pH, and sulfite concentrations in boiler and feedwater is essential in preventing hazardous or costly situations. These parameters are important in determining the corrosive characteristics of water due to carbonates and chloride. Sulfite is also critical to prevent pitting and oxidation of metal components. A high level of sulfite results in a lowered pH, which can also promote corrosion.

Specifications	HI3827 Test Kit for Boilers				
Test	Type	Range	Smallest Increment	Method	Number of Tests
Alkalinity (as CaCO <sub>3</sub> )	titration	0-100 mg/L (ppm) 0-300 mg/L (ppm)	1 mg/L (ppm) 3 mg/L (ppm)	phenolphthalein/ bromphenol blue	110 avg.
Chloride (as Cl <sup>-</sup> )	titration	0-100 mg/L (ppm) 0-1000 mg/L (ppm)	1 mg/L (ppm) 10 mg/L (ppm)	mercuric nitrate	110 avg.
Hardness (as CaCO <sub>3</sub> )	titration	0.0-30.0 mg/L (ppm) 0-300 mg/L (ppm)	0.3 mg/L (ppm) 3 mg/L (ppm)	EDTA	100 avg.
Phosphate (as PO <sub>4</sub> <sup>3-</sup> )	colorimetric	0-5 mg/L (ppm)	1 mg/L (ppm)	ascorbic acid	50 avg
pH	electronic pH tester	0.0-14.0 pH	0.1 pH	-	life of the meter
Sulfite (as Na <sub>2</sub> SO <sub>3</sub> )	titration	0.0-20.0 mg/L (ppm) 0-200 mg/L (ppm)	0.2 mg/L (ppm) 2 mg/L (ppm)	iodometric	110 avg.
Dimensions	440 x 330 x 100 mm (17.3 x 13.0 x 3.9")				
<b>Ordering Information</b>	<b>HI3827</b> test kit includes all of the necessary reagents and accessories to perform over 100 tests for every parameter, with the exception of phosphate, which includes reagents for 50 tests, hard carrying cases and instructions.				
<b>Reagents</b>	<b>HI3811-100</b> Alkalinity (as CaCO <sub>3</sub> ), 110 tests avg.		<b>HI70004P</b> pH 4.01 buffer solution, 20 mL sachets (25)		
	<b>HI3815-100</b> Chloride, 110 tests avg.		<b>HI70007P</b> pH 7.01 buffer solution, 20 mL sachets (25)		
	<b>HI3812-100</b> Hardness, total (as CaCO <sub>3</sub> ), 100 tests avg.		<b>HI70010P</b> pH 10.01 buffer solution, 20 mL sachets (25)		
	<b>HI3833-050</b> Phosphate, 50 tests avg.		<b>HI3822-100</b> Sulfite (as Na <sub>2</sub> SO <sub>3</sub> ), 110 tests avg.		





HI3821

## Cooling and Boiler Test Kit

The HI3821 is a chemical test kit that determines that uses titration and colorimetry to measure six parameters common to cooling and boiler systems: alkalinity, chloride, hardness, dissolved oxygen, phosphate, and sulfite. The HI3821 is supplied with all of the necessary reagents and equipment to perform each analysis, and all reagents are individually available as they run out.

- **Complete setup**
  - All required materials are included with the test kit, such as the dissolved oxygen glass bottle, sample beaker, indicator and reagent bottles and packets, and color comparison cube.
- **High resolution**
  - All tests provide a high resolution based on the expected range of measurement.
- **Replacement reagents available**
  - There is no need to buy a new kit when reagents are exhausted. The reagents for each parameter can be ordered individually.

### Significance of Use

Corrosion can occur in many key areas of a boiler. It can shorten the life of a boiler, or at the very least, increase the costs associated with maintaining a boiler. Corrosion can form in water heaters, deaerators, superheater tubes, and economizers, among other places. Monitoring the alkalinity, chloride, hardness, dissolved oxygen, phosphate, and sulfite concentrations in cooling and boiler systems is essential in preventing hazardous or costly situations.

Specifications	HI3821 Cooling and Boiler Combination Test Kit				
Test	Type	Range	Smallest Increment	Method	Number of Tests
Alkalinity (as CaCO <sub>3</sub> )	titration	0-100 mg/L (ppm) 0-300 mg/L (ppm)	1 mg/L (ppm) 3 mg/L (ppm)	phenolphthalein/ bromphenol blue	110 avg.
Chloride (as Cl <sup>-</sup> )	titration	0-100 mg/L (ppm) 0-1000 mg/L (ppm)	1 mg/L (ppm) 10 mg/L (ppm)	mercuric nitrate	110 avg.
Hardness (as CaCO <sub>3</sub> )	titration	0.0-30.0 mg/L (ppm) 0-300 mg/L (ppm)	0.3 mg/L (ppm) 3 mg/L (ppm)	EDTA	100 avg.
Phosphate (as PO <sub>4</sub> <sup>3-</sup> )	colorimetric	0-5 mg/L (ppm)	1 mg/L (ppm)	ascorbic acid	50 avg
Oxygen, Dissolved	titration	0.0-10.0 mg/L (ppm)	0.1 mg/L (ppm)	modified Winkler	110 avg.
Sulfite (as Na <sub>2</sub> SO <sub>3</sub> )	titration	0.0-20.0 mg/L (ppm) 0-200 mg/L (ppm)	0.2 mg/L (ppm) 2 mg/L (ppm)	iodometric	110 avg.
Dimensions	440 x 330 x 100 mm (17.3 x 13.0 x 3.9")				
<b>Ordering Information</b>	<b>HI3821</b> test kit includes all of the necessary reagents and accessories to perform over 100 tests for every parameter, with the exception of phosphate, which includes reagents for 50 tests, hard carrying case and instructions.				
<b>Reagents</b>	<b>HI3811-100</b> Alkalinity (as CaCO <sub>3</sub> ), 110 tests avg.		<b>HI3833-050</b> Phosphate, 50 tests avg.		
	<b>HI3815-100</b> Chloride, 110 tests avg.		<b>HI3810-100</b> Dissolved Oxygen, 110 tests avg.		
	<b>HI3812-100</b> Hardness, total (as CaCO <sub>3</sub> ), 100 tests avg.		<b>HI3822-100</b> Sulfite (as Na <sub>2</sub> SO <sub>3</sub> ), 110 tests avg.		

HI3814

# Environmental Monitoring Test Kit

*Ideal for Professionals and Students*

The HI3814 is a chemical test kit that determines that uses titration and direct measurement to measure six parameters common in environmental testing: acidity, alkalinity, carbon dioxide, hardness, dissolved oxygen, and pH. The HI3814 is supplied with all of the necessary reagents and equipment to perform each analysis, and all reagents are individually available as they run out.

- **Complete setup**
  - All required materials are included with the test kit, such as the pH tester, sample beaker, indicator and reagent bottles and packets, and glass bottle for dissolved oxygen.
- **High resolution**
  - All tests provide a high resolution based on the expected range of measurement.
- **Replacement reagents available**
  - There is no need to buy a new kit when reagents are exhausted. The reagents for each parameter can be ordered individually.



## Significance of Use

The six most important parameters in environmental applications can be monitored with this combination chemical test kit. They include: acidity, alkalinity, carbon dioxide, dissolved oxygen, hardness, and pH. This kit is ideal not only for professionals, but also for students studying environmental science, as it offers great performance and ease of use. HI3814 is equipped with all the accessories and reagents to perform over 100 tests for each parameter. The pHep®, our popular pH electronic tester, is included for your convenience. This small and easy to use pH meter will provide more accurate and reliable pH readings than conventional litmus paper. The pHep® also has the added benefit of introducing students to the use of a pH meter.

Specifications	HI3814 Environmental Monitoring Test Kit				
Test	Type	Range	Smallest Increment	Method	Number of Tests
Acidity (as CaCO <sub>3</sub> )	titration	0-100 mg/L (ppm) 0-500 mg/L (ppm)	1 mg/L (ppm) 5 mg/L (ppm)	methyl-orange/ phenolphthalein	110 avg.
Alkalinity (as CaCO <sub>3</sub> )	titration	0-100 mg/L (ppm) 0-300 mg/L (ppm)	1 mg/L (ppm) 3 mg/L (ppm)	phenolphthalein/ bromphenol blue	110 avg.
Carbon Dioxide	titration	0.0-10.0 mg/L (ppm) 0.0-50.0 mg/L (ppm) 0-100 mg/L (ppm)	0.1 mg/L (ppm) 0.5 mg/L (ppm) 1 mg/L (ppm)	phenolphthalein	110 avg.
Hardness (as CaCO <sub>3</sub> )	titration	0.0-30.0 mg/L (ppm) 0-300 mg/L (ppm)	0.3 mg/L (ppm) 3 mg/L (ppm)	EDTA	100 avg.
Oxygen, Dissolved	titration	0.0-10.0 mg/L (ppm)	0.1 mg/L (ppm)	modified Winkler	110 avg.
pH	electronic pH tester	0.0-14.0 pH	0.1 pH	-	life of the meter
Dimensions	440 x 330 x 100 mm (17.3 x 13.0 x 3.9")				
<b>Ordering Information</b>	<b>HI3814</b> test kit includes all of the necessary reagents and accessories to perform over 100 tests for every parameter, electronic pH tester, hard carrying case and instructions.				
<b>Reagents</b>	<b>HI3820-100</b> Acidity (as CaCO <sub>3</sub> ), 110 tests avg.		<b>HI3810-100</b> Dissolved Oxygen, 110 tests avg.		
	<b>HI3811-100</b> Alkalinity (as CaCO <sub>3</sub> ), 110 tests avg.		<b>HI70004P</b> pH 4.01 buffer solution, 20 mL sachets (25)		
	<b>HI3818-100</b> Carbon Dioxide, 110 tests avg.		<b>HI70007P</b> pH 7.01 buffer solution, 20 mL sachets (25)		
	<b>HI3812-100</b> Hardness, total (as CaCO <sub>3</sub> ), 100 tests avg.		<b>HI70010P</b> pH 10.01 buffer solution, 20 mL sachets (25)		



HI3823

## Marine Test Kit

HI 3823 provides users with the most important test parameters for aquaculture applications: alkalinity, carbon dioxide, dissolved oxygen, hardness, pH and salinity.

Each of these parameters plays a critical role in the delicate balance of the aquatic environment: alkalinity acts as a stabilizer for pH; carbon dioxide must be monitored because of its toxic effects on fish (every species can tolerate different levels of CO<sub>2</sub>); oxygen levels affect fish respiration and incorrect concentrations can slow down their growth rate; hardness is monitored because it diminishes the toxicity level of ammonia; pH also is measured to determine the toxicity level of the water; salinity is important because of its relation to dissolved oxygen.

- **Complete setup**
  - All required materials are included with the test kit, such as the pH tester, sample beaker, indicator and reagent bottles and packets, and glass bottle for dissolved oxygen.
- **High resolution**
  - All tests provide a high resolution based on the expected range of measurement.
- **Replacement reagents available**
  - There is no need to buy a new kit when reagents are exhausted. The reagents for each parameter can be ordered individually.

Specifications	HI3823 Marine Test Kit				
Test	Type	Range	Smallest Increment	Method	Number of Tests
Alkalinity (as CaCO <sub>3</sub> )	titration	0-100 mg/L (ppm) 0-300 mg/L (ppm)	1 mg/L (ppm) 3 mg/L (ppm)	phenolphthalein/ bromphenol blue	110 avg.
Carbon Dioxide	titration	0.0-10.0 mg/L (ppm) 0.0-50.0 mg/L (ppm) 0-100 mg/L (ppm)	0.1 mg/L (ppm) 0.5 mg/L (ppm) 1 mg/L (ppm)	phenolphthalein	110 avg.
Hardness (as CaCO <sub>3</sub> )	titration	0.0-30.0 mg/L (ppm) 0-300 mg/L (ppm)	0.3 mg/L (ppm) 3 mg/L (ppm)	EDTA	100 avg.
Oxygen, Dissolved	titration	0.0-10.0 mg/L (ppm)	0.1 mg/L (ppm)	modified Winkler	110 avg.
pH	electronic pH tester	0.0-14.0 pH	0.1 pH	-	life of the meter
Salinity	titration	0.0-40.0 g/kg	0.4 g/kg	mercuric nitrate	110 avg.
Dimensions	440 x 330 x 100 mm (17.3 x 13.0 x 3.9")				
<b>Ordering Information</b>	<b>HI3823</b> test kit includes all reagents and accessories necessary to perform over 100 tests for each parameter, electronic pH tester, hard carrying case and instructions.				
<b>Reagents</b>	<b>HI3811-100</b> Alkalinity (as CaCO <sub>3</sub> ), 110 tests avg.		<b>HI70004P</b> pH 4.01 buffer solution, 20 mL sachets (25)		
	<b>HI3818-100</b> Carbon Dioxide, 110 tests avg.		<b>HI70007P</b> pH 7.01 buffer solution, 20 mL sachets (25)		
	<b>HI3812-100</b> Hardness, total (as CaCO <sub>3</sub> ), 100 tests avg.		<b>HI70010P</b> pH 10.01 buffer solution, 20 mL sachets (25)		
	<b>HI3810-100</b> Dissolved Oxygen, 110 tests avg.		<b>HI3835-100</b> Salinity, 100 tests avg.		



HI3887

## Quick-Check Swimming Pool Test Kit

Free Chlorine and pH

The HI3887 is a colorimetric chemical test kit that determines the free chlorine concentration and pH level in samples within a 0.0 to 2.5 mg/L (ppm)  $\text{Cl}^-$  range and 6.0 to 8.5 pH range. The HI3887 is supplied with all of the necessary reagents and equipment to perform the analysis. The test kit contains enough reagents to perform approximately 50 tests for free chlorine and 100 tests for pH.

- **Complete setup**
  - All required materials are included with the test kit, such as the color comparison cubes and reagent dropper bottles.
- **High resolution**
  - Free chlorine readings from 0.0 to 2.5 mg/L are determined to 0.5 mg/L resolution.
  - pH readings from 6.0 to 8.5 pH are determined to 0.5 pH resolution.

### Significance of Use

Chlorine is one of the most commonly used disinfectants for drinking water, wastewater, and water used for pools and spas. It can be added to in various forms including calcium hypochlorite, sodium

hypochlorite, or in some instances, chlorine gas. When added to water, chlorine creates hypochlorous acid (HOCl) which dissociates into hypochlorite ion ( $\text{OCl}^-$ ).



hypochlorous acid  $\leftrightarrow$  hydrogen ion + hypochlorite ion

HOCl is the form of chlorine that acts as a stronger disinfectant as compared to  $\text{OCl}^-$ . To ensure the added chlorine is effective at sanitizing, the pH of the water must be taken into account. Around pH 7.5, HOCl and  $\text{OCl}^-$  are present in relatively equal amounts. Below pH 7.5, the equilibrium shifts to favor HOCl; above pH 7.5, the equilibrium shifts to favor  $\text{OCl}^-$ . Depending on the application, addition of chlorine is effective when added to water with a neutral or slightly acidic pH value.

When chlorine is first added to water, it is available as free chlorine. The measurement of free chlorine signifies the amount available for disinfection. Once chlorine begins to sanitize bacteria and pathogens present in the water, it becomes combined chlorine; combined chlorine is no longer available to act as a disinfectant.

Specifications	HI3887 Quick-Check Swimming Pool Test Kit				
Test	Type	Range	Smallest Increment	Method	Number of Tests
Free Chlorine	colorimetric	0-2.5 mg/L (ppm)	0.5 mg/L (ppm)	DPD	50 avg.
pH	colorimetric	6.0-8.5 pH	0.5 pH	pH indicator	100 avg.
<b>Ordering Information</b>	<b>HI3887</b> test kit includes color comparison cubes (2), 20 mL reagent 1, 12 mL reagent 2, 25 mL pH reagent and instructions.				
<b>Reagents</b>	<b>HI3831F-050</b> free chlorine, 50 tests avg.				



HI3817

## Water Quality Test Kit

*Accurate and Reliable Water Quality Tests*

Monitor the most important chemical parameters in water: alkalinity, chloride, hardness, iron, pH and sulfite with this combination test kit.

The kit has all the reagents needed to perform over 100 tests for each parameter, with the exception of iron, which includes reagents for 50 tests. Reagents may also be purchased individually as they run out (please see our reagent section for a complete listing).

pH measurements are performed with our electronic pHep® pH tester which guarantees more accurate and repeatable readings than litmus paper.

The chemical reagents to perform each test are provided in numerically labeled bottles and are easy to identify.

The kit is supplied with a convenient hard carrying case designed with field applications in mind. It will also keep your test kit neat and organized.

The Hanna HI3817 combination test kit offers all the necessary equipment for accurate and reliable water quality testing.

Specifications	HI3817 Water Quality Test Kit				
Test	Type	Range	Smallest Increment	Method	Number of Tests
Alkalinity (as CaCO <sub>3</sub> )	titration	0-100 mg/L (ppm) 0-300 mg/L (ppm)	1 mg/L (ppm) 3 mg/L (ppm)	phenolphthalein/ bromphenol blue	110 avg.
Chloride (as Cl <sup>-</sup> )	titration	0-100 mg/L (ppm) 0-1000 mg/L (ppm)	1 mg/L (ppm) 10 mg/L (ppm)	mercuric nitrate	110 avg.
Hardness (as CaCO <sub>3</sub> )	titration	0.0-30.0 mg/L (ppm) 0-300 mg/L (ppm)	0.3 mg/L (ppm) 3 mg/L (ppm)	EDTA	100 avg.
Iron	colorimetric	0-5 mg/L (ppm)	1 mg/L (ppm)	phenanthroline	50 avg
pH	electronic pH tester	0.0-14.0 pH	0.1 pH	-	life of the meter
Sulfite (as Na <sub>2</sub> SO <sub>3</sub> )	titration	0.0-20.0 mg/L (ppm) 0-200 mg/L (ppm)	0.2 mg/L (ppm) 2 mg/L (ppm)	iodometric	110 avg.
Dimensions	440 x 330 x 100 mm (17.3 x 13.0 x 3.9")				
<b>Ordering Information</b>	<b>HI3817</b> test kit includes all of the necessary reagents and accessories to perform over 100 tests for every parameter, with the exception of iron, which include reagents for 50 tests, electronic pH tester, hard carrying case and instructions.				
<b>Reagents</b>	<b>HI3811-100</b> Alkalinity (as CaCO <sub>3</sub> ), 110 tests avg.		<b>HI70004P</b> pH 4.01 buffer solution, 20 mL sachets (25)		
	<b>HI3815-100</b> Chloride, 110 tests avg.		<b>HI70007P</b> pH 7.01 buffer solution, 20 mL sachets (25)		
	<b>HI3812-100</b> Hardness, total (as CaCO <sub>3</sub> ), 100 tests avg.		<b>HI70010P</b> pH 10.01 buffer solution, 20 mL sachets (25)		
	<b>HI3834-050</b> iron, 50 tests avg.		<b>HI3822-100</b> Sulfite (as Na <sub>2</sub> SO <sub>3</sub> ), 110 tests avg.		



backpacklab.com

Chemical Test Kits

Backpack Lab



Test kits can be replaced individually

# A Classroom in a Backpack!

# Backpack Lab® Water Quality Educational Test Kit

## Backpack Lab Water Quality Educational Test Kit Includes:

- 110 tests each for acidity and alkalinity, 100 tests for carbon dioxide, dissolved oxygen, hardness, nitrate and phosphate
- Hanna's HI98129 Combo pH/EC/TDS/temperature tester
- Secchi disk for turbidity
- Backpack carrying case which holds all components of the kit
- Teacher's manual with a curriculum that meets National Science Teachers Association Standards
- Parameter summary in PDF and PowerPoint format (on included CD)
- Laminated, laboratory instruction cards with step-by-step field test procedures
- Reproducible lab activity worksheets with instructions, goals, hypothesis, and testing procedure results/observations (on included CD)

- A glossary of key terms in PDF format (on included CD)

Hanna offers a series of test kits specifically designed for educators and environmental science students. These portable kits contain well-constructed lessons and activities, and will allow the teacher to get the most out of their classroom time.

Backpack Lab is designed with all the necessary components in one place, reducing the chance of misplacing an item. Ideal for transporting, take this durable backpack to the field for on-site measurements.

The lesson plan and components are tied together by a comprehensive teacher's manual that includes information about each parameter, classroom activities designed to introduce students to each parameter, and detailed field-testing procedures. Hanna chemical test kits and pocket testers provide teachers with a valuable tool in helping students assess the water quality of streams, rivers and lakes.

Specifications HI3817BP Backpack Lab Water Quality Test Kit					
Test	Type	Range	Method	Number of Tests	Individual Kit Reorder Code
Acidity (CaCO <sub>3</sub> )	titration	0-100 mg/L (ppm) 0-500 mg/L (ppm)	methyl-orange phenolphthalein	110 avg.	HI3820
Alkalinity (CaCO <sub>3</sub> ) Phenolphthalein & Total	titration	0-100 mg/L (ppm) 0-300 mg/L (ppm)	phenolphthalein/ bromphenol blue	110 avg.	HI3811
Carbon Dioxide	titration	0.0-10.0 mg/L (ppm) 0.0-50.0 mg/L (ppm) 0-100 mg/L (ppm)	phenolphthalein	110 avg.	HI3818
Oxygen, Dissolved	titration	0.0-10.0 mg/L (ppm)	modified Winkler	110 avg.	HI3810
Hardness (CaCO <sub>3</sub> )	titration	0.0-30.0 mg/L (ppm) 0-300 mg/L (ppm)	EDTA	100 avg.	HI3812
Nitrate (NO <sub>3</sub> <sup>-</sup> -N)	colorimetric	0-50 mg/L (ppm)	cadmium reduction	100	HI3874
Phosphate	colorimetric	0-5 mg/L (ppm)	ascorbic acid	50	HI3833
Specifications HI98129 Combo pH/EC/TDS/Temperature Tester					
Type	Range	Resolution	Accuracy	Calibration	
pH	0.00 to 14.00 pH	0.01 pH	±0.05 pH	automatic, one or two-point with two sets of standard buffers (pH 4.01 / 7.01 / 10.01 or 4.01 / 6.86 / 9.18)	
Conductivity	0 to 3999 µS/cm	1 µS/cm	±2% F.S.	automatic, one point at 1413 µS/cm	
TDS	0 to 2000 mg/L (ppm)	1 mg/L (ppm)	±2% F.S.	automatic, one point at 1382 mg/L (ppm)	
Temperature	0.0 to 60.0°C / 32.0 to 140.0°F	0.1°C / 0.1°F	±0.5°C / ±1°F	-	
Ordering Information	<b>HI3817BP</b> Backpack Lab includes HI98129 Combo pH/EC/TDS/temperature tester, acidity test kit, alkalinity test kit, carbon dioxide test kit, dissolved oxygen test kit, hardness test kit, nitrate test kit, phosphate test kit, set of 10 field test procedures, teacher's resource CD, teacher's guide and backpack.				
Reagents and Solutions only	<b>HI3820-100</b> Acidity (as CaCO <sub>3</sub> ), 110 tests avg. <b>HI3811-100</b> Alkalinity (as CaCO <sub>3</sub> ), 110 tests avg. <b>HI3818-100</b> Carbon Dioxide, 110 tests avg. <b>HI3810-100</b> Dissolved Oxygen, 110 tests avg. <b>HI3812-100</b> Hardness, total (as CaCO <sub>3</sub> ), 100 tests avg. <b>HI3874-100</b> nitrate (as NO <sub>3</sub> <sup>-</sup> -N), 100 tests avg.		<b>HI3833-050</b> Phosphate, 50 tests avg. <b>HI70004P</b> pH 4.01 buffer solution for HI98129, 20 mL sachets (25) <b>HI70007P</b> pH 7.01 buffer solution for HI98129, 20 mL sachets (25) <b>HI70010P</b> pH 10.01 buffer solution for HI98129, 20 mL sachets (25) <b>HI70031P</b> 1413 µS/cm conductivity calibration solution for HI98129, 20 mL sachets (25) <b>HI70032P</b> 1382 mg/L (ppm) TDS calibration solution for HI98129, 20 mL sachets (25)		

Backpack Lab™ contents subject to change



backpacklab.com



Test kits can be replaced individually

# A Classroom in a Backpack!



# Backpack Lab® Soil Quality Educational Test Kit

## Backpack Lab Soil Quality Educational Test Kit Includes:

- Agriculture combination test kit for testing nitrogen, phosphorus, potassium (N,P,K) with enough materials for 50 tests of each parameter
- Hanna's HI98129 Combo pH/EC/TDS/temperature tester
- Hanna's HI145 digital thermometer
- Backpack carrying case which holds all components of the kit
- Teacher's manual with a curriculum that meets National Science Teachers Association Standards
- Parameter summary in PDF and PowerPoint format (on included CD)
- Laminated, laboratory instruction cards with step-by-step field test procedures
- Reproducible lab activity worksheets with instructions, goals, hypothesis and testing procedure results/observations (on included CD)
- A glossary of key terms in PDF format (on included CD)

Hanna introduces a kit specifically assembled for the educator and environmental science student. Using the popular Hanna Agricultural Combination Test Kit (HI3896) as its foundation, the Soil Quality Education Test Kit is designed to provide a complete lesson plan for teachers. Teachers are able to introduce students to important chemical tests for evaluating soil quality and fertility, and relate these measurements to the principles of plant metabolism. Tied together by an extensive teacher's guide, this kit includes in-depth background information about each parameter, classroom activities designed to introduce students to each parameter and field-testing procedures.

The Hanna Agricultural Combination Test Kit addresses important issues related to soil quality and modern agriculture practices. Real-world examples help students understand the relevance of macronutrients and other parameters in everyday life. This kit introduces the student to all major soil quality topics, and is presented in an easy-to-use format that makes lessons accessible, understandable and memorable.

Specifications	HI3896BP Backpack Lab Soil Quality Test Kit				
Test	Type	Range	Method	Number of Tests	Individual Kit Reorder Code
Nitrogen	colorimetric	traces, low, medium, high	Ned	25	HI3896-025
Phosphorus	colorimetric	traces, low, medium, high	ascorbic acid	25	HI3896-025
Potassium	turbidimetric	traces, low, medium, high	tetraphenylborate	25	HI3896-025
pH	colorimetric	4 to 9 pH (1 pH increments)	pH indicators	25	HI3896-025
Specifications	HI98129 Combo pH/EC/TDS/Temperature Tester				
Type	Range	Resolution	Accuracy	Calibration	
pH	0.00 to 14.00 pH	0.01 pH	±0.05 pH	automatic, one or two-point with two sets of standard buffers (pH 4.01 / 7.01 / 10.01 or 4.01 / 6.86 / 9.18)	
Conductivity	0 to 3999 µS/cm	1 µS/cm	±2% F.S.	automatic, one point at 1413 µS/cm	
TDS	0 to 2000 mg/L (ppm)	1 mg/L (ppm)	±2% F.S.	automatic, one point at 1382 mg/L (ppm)	
Temperature	0.0 to 60.0°C / 32.0 to 140.0°F	0.1°C / 0.1°F	±0.5°C / ±1°F	-	
Specifications	HI145-00 T-Shaped Thermometer				
Type	Range	Resolution	Accuracy	Probe	
Temperature	-50.0 to 220°C	0.1°C (-50.0 to 199.9°C); 1°C (200 to 220°C)	±0.3°C (-20 to 90°C); ±0.4% F.S. (outside)	stainless steel probe; 125 mm x dia 5 mm (4.9 x dia 0.2")	
Ordering Information	<b>HI3896BP</b> Backpack Lab test kit includes agriculture test kit pro, HI98129 Combo pH/EC/TDS/temperature tester, HI145 digital thermometer, set of 6 field test procedures, teacher's resource CD, teacher's guide and backpack				
Reagents and Solutions only	<b>HI3896-025</b> nitrogen, phosphorus, potassium and pH, 25 tests each <b>HI70004P</b> pH 4.01 buffer solution for HI98129, 20 mL sachets (25) <b>HI70007P</b> pH 7.01 buffer solution for HI98129, 20 mL sachets (25) <b>HI70010P</b> pH 10.01 buffer solution for HI98129, 20 mL sachets (25) <b>HI70031P</b> 1413 µS/cm conductivity calibration solution for HI98129, 20 mL sachets (25) <b>HI70032P</b> 1382 mg/L (ppm) TDS calibration solution for HI98129, 20 mL sachets (25)				

Backpack Lab™ contents subject to change



backpacklab.com

Chemical Test Kits

Backpack Lab



Test kits can be replaced individually

# A Classroom in a Backpack!

# Backpack Lab® Marine Science Educational Test Kit

## Backpack Lab® Includes:

- 110 tests each for acidity and alkalinity, 100 tests for ammonia, carbon dioxide, dissolved oxygen, hardness, nitrate, nitrogen, phosphate and salinity
- Hanna's HI98129 Combo pH/EC/TDS/temperature tester
- Hydrometer for salinity
- Secchi disk for turbidity
- Backpack-style carrying case which holds all components of the kit
- Teacher's manual with a curriculum that meets National Science Teachers Association Standards
- Parameter summary in PDF and PowerPoint format (on included CD)
- Laminated, laboratory instruction cards with step-by-step field-test procedures

- Reproducible lab activity worksheets with instructions, goals, hypothesis, and testing procedure results/observations (on included CD)
- A glossary of key terms in PDF format (on included CD)

Backpack Lab is designed with all the necessary components in one place, reducing the chance of misplacing an item. Ideal for transporting, take this durable backpack to the field for on-site measurements.

This kit is designed to provide a complete unit for teachers to introduce students to important marine science topics. The teacher's guide provides detailed background information for marine science lessons and activities that can be adapted to various grade levels. Field tests are included to complement classroom lessons. All materials fit easily into the supplied backpack for convenient transport.

Specifications	HI3899BP Backpack Lab Marine Science Educational Test Kit				
Test	Type	Range	Method	Number of Tests	Individual Kit Reorder Code
Acidity (CaCO <sub>3</sub> )	titration	0-100 mg/L (ppm) 0-500 mg/L (ppm)	methyl-orange phenolphthalein	110 avg.	HI3820
Alkalinity (CaCO <sub>3</sub> ) Phenolphthalein & Total	titration	0-100 mg/L (ppm) 0-300 mg/L (ppm)	phenolphthalein/ bromphenol blue	110 avg.	HI3811
Ammonia (as NH <sub>3</sub> -N) in saltwater	colorimetric	0.0-2.5 mg/L (ppm)	Nessler	25 avg.	HI3826
Carbon Dioxide	titration	0.0-10.0 mg/L (ppm) 0.0-50.0 mg/L (ppm) 0-100 mg/L (ppm)	phenolphthalein	110 avg.	HI3818
Oxygen, Dissolved	titration	0.0-10.0 mg/L (ppm)	modified Winkler	110 avg.	HI3810
Nitrite	colorimetric	0.0-1.0 mg/L (ppm)	chromotropic acid	100	HI3873
Nitrate (NO <sub>3</sub> <sup>-</sup> -N)	colorimetric	0-50 mg/L (ppm)	cadmium reduction	100	HI3874
Phosphate	colorimetric	0-5 mg/L (ppm)	ascorbic acid	50	HI3833
Salinity	titration	0.0-40.0 g/kg	mercuric nitrate	110 avg.	HI3835

Specifications	HI98129 Combo pH/EC/TDS/Temperature Tester			
Type	Range	Resolution	Accuracy	Calibration
pH	0.00 to 14.00 pH	0.01 pH	±0.05 pH	automatic, one or two-point with two sets of standard buffers (pH 4.01 / 7.01 / 10.01 or 4.01 / 6.86 / 9.18)
Conductivity	0 to 3999 µS/cm	1 µS/cm	±2% F.S.	automatic, one point at 1413 µS/cm
TDS	0 to 2000 mg/L (ppm)	1 mg/L (ppm)	±2% F.S.	automatic, one point at 1382 mg/L (ppm)
Temperature	0.0 to 60.0°C / 32.0 to 140.0°F	0.1°C / 0.1°F	±0.5°C / ±1°F	–

<b>Ordering Information</b>	<b>HI3899BP</b> Backpack Lab includes acidity test kit, alkalinity test kit, carbon dioxide test kit, ammonia test kit, dissolved oxygen test kit, nitrate test kit, nitrite test kit, phosphate test kit, salinity test kit, secchi disc, hydrometer, HI98129 Combo pH/EC/TDS/temperature tester, set of 6 field test procedures, teacher's resource CD, teacher's guide and backpack.	
<b>Reagents and Solutions only</b>	<b>HI3820-100</b> Acidity (as CaCO <sub>3</sub> ), 110 tests avg. <b>HI3811-100</b> Alkalinity (as CaCO <sub>3</sub> ), 110 tests avg. <b>HI3826-025</b> Ammonia, seawater (as NH <sub>3</sub> -N), 25 tests avg. <b>HI3818-100</b> Carbon Dioxide, 110 tests avg. <b>HI3810-100</b> Dissolved Oxygen, 110 tests avg. <b>HI3874-100</b> nitrate (as NO <sub>3</sub> <sup>-</sup> -N), 100 tests avg. <b>HI3873-100</b> nitrite (as NO <sub>2</sub> <sup>-</sup> -N), 100 tests avg.	<b>HI3833-050</b> Phosphate, 50 tests avg. <b>HI3835-100</b> salinity, 100 tests avg. <b>HI70004P</b> pH 4.01 buffer solution for HI98129, 20 mL sachets (25) <b>HI70007P</b> pH 7.01 buffer solution for HI98129, 20 mL sachets (25) <b>HI70010P</b> pH 10.01 buffer solution for HI98129, 20 mL sachets (25) <b>HI70031P</b> 1413 µS/cm conductivity calibration solution for HI98129, 20 mL sachets (25) <b>HI70032P</b> 1382 mg/L (ppm) TDS calibration solution for HI98129, 20 mL sachets (25)

Backpack Lab™ contents subject to change

CTK Code	Test Kit Parameter	Chemical Method	Reagent Code	# Tests	
HI3810	Dissolved Oxygen	Winkler	HI3810-100	110 avg.	
HI3811	Alkalinity (as CaCO <sub>3</sub> )	phenolphthalein/bromphenol blue	HI3811-100	110 avg.	
HI3812	Hardness, total (as CaCO <sub>3</sub> )	EDTA titration	HI3812-100	100 avg.	
HI3814	Dissolved Oxygen	Winkler	HI3810-100	110 avg.	
	Alkalinity (as CaCO <sub>3</sub> )	phenolphthalein/bromphenol blue	HI3811-100	110 avg.	
	Hardness, Total (as CaCO <sub>3</sub> )	EDTA titration	HI3812-100	100 avg.	
	Carbon Dioxide	phenolphthalein titration	HI3818-100	110 avg.	
	Acidity (as CaCO <sub>3</sub> )	methyl-orange/phenolphthalein	HI3820-100	110 avg.	
	Buffer solution	–	HI70004P	25	
	Buffer solution	–	HI70007P	25	
HI3815	Chloride	mercuric nitrate titration	HI3815-100	110 avg.	
	Alkalinity (as CaCO <sub>3</sub> )	phenolphthalein/bromphenol blue	HI3811-100	110 avg.	
	Hardness, total (as CaCO <sub>3</sub> )	EDTA titration	HI3812-100	100 avg.	
	Chloride	mercuric nitrate titration	HI3815-100	110 avg.	
	Sulfite (as Na <sub>2</sub> SO <sub>3</sub> )	titration	HI3822-100	110 avg.	
	Iron	phenanthroline	HI3834-050	50 avg.	
	Buffer solution	–	HI70004P	25	
HI3817	Buffer solution	–	HI70007P	25	
	Buffer solution	–	HI70010P	25	
	Dissolved Oxygen	Winkler	HI3810-100	110 avg.	
	Alkalinity (as CaCO <sub>3</sub> )	phenolphthalein/bromphenol blue	HI3811-100	110 avg.	
	Hardness, total (as CaCO <sub>3</sub> )	EDTA titration	HI3812-100	100 avg.	
	Carbon Dioxide	phenolphthalein titration	HI3818-100	110	
	Acidity (as CaCO <sub>3</sub> )	methyl orange/phenolphthalein	HI3820-100	110	
HI3817BP	Phosphate	ascorbic acid	HI3833-050	50	
	Nitrate (as NO <sub>3</sub> <sup>-</sup> -N)	cadmium reduction	HI3874-100	100	
	Buffer solution	–	HI70004P	25	
	Buffer solution	–	HI70007P	25	
	Buffer solution	–	HI70010P	25	
	EC Calibration Standard	–	HI70031P	25	
	EC Calibration Standard	–	HI7033M	1 bottle (230 mL)	
	HI3818	Carbon Dioxide	phenolphthalein titration	HI3818-100	110 avg.
	HI3820	Acidity (as CaCO <sub>3</sub> )	methyl orange/phenolphthalein	HI3820-100	110 avg.
	HI3821	Alkalinity (as CaCO <sub>3</sub> )	phenolphthalein/bromphenol blue	HI3811-100	110 avg.
Chloride		mercuric nitrate titration	HI3815-100	110 avg.	
Hardness, total (as CaCO <sub>3</sub> )		EDTA titration	HI3812-100	100 avg.	
Dissolved Oxygen		Winkler	HI3810-100	110 avg.	
Phosphate		ascorbic acid	HI3833-050	50	
Sulfite (as Na <sub>2</sub> SO <sub>3</sub> )		titration	HI3822-100	110 avg.	
HI3822	Sulfite (as Na <sub>2</sub> SO <sub>3</sub> )	titration	HI3822-100	110 avg.	
HI3824	Ammonia (fresh water) (as NH <sub>3</sub> -N)	Nessler colorimetric	HI3824-025	25 avg.	
HI3826	Ammonia (seawater) (as NH <sub>3</sub> -N)	Nessler colorimetric	HI3826-025	25 avg.	

CTK Code	Test Kit Parameter	Chemical Method	Reagent Code	# Tests
HI3829F	Chlorine, free	DPD colorimetric	HI3829F-050	50 avg
HI3830	Bromine	DPD colorimetric	HI3830-060	60 avg.
HI3831F	Chlorine, free	DPD colorimetric	HI3831F-050	50 avg
HI3831T	Chlorine, total	DPD colorimetric	HI3831T-050	50 avg
HI3833	Phosphate	ascorbic acid	HI3833-050	50
HI3834	Iron	phenanthroline	HI3834-050	50 avg.
HI3835	Chloride	mercuric nitrate	HI3835-100	110 avg.
HI3838	Formaldehyde	acid titration	HI3838-100	110 avg
HI3840	Hardness LR (as CaCO <sub>3</sub> )	EDTA titration	HI3840	50 avg
HI3841	Hardness MR (as CaCO <sub>3</sub> )	EDTA titration	HI3841	50 avg
HI3842	Hardness HR (as CaCO <sub>3</sub> )	EDTA titration	HI3842	50 avg
HI3843	Hypochlorite (bleach)	iodometric	HI3843-100	100 avg
HI3844	Hydrogen Peroxide	iodometric	HI3844-100	100 avg
HI3846	Chromium VI	diphenylcarbohydrazide	HI3846-100	100 avg
HI3847	Copper	bicinchoninate	HI3847-100	100
HI3859	Glycol	oxidation	HI3859-025	25
HI3873	Nitrite (as NO <sub>2</sub> <sup>-</sup> -N)	chromotropic acid	HI3873-100	100
HI3874	Nitrate (as NO <sub>3</sub> <sup>-</sup> -N)	cadmium reduction	HI3874-100	100
HI3875	Chlorine, free	DPD colorimetric	HI3875-100	100
HI3887	Chlorine, free	DPD colorimetric	HI3831F-050	50 avg
HI3895	Nitrogen	Ned	HI3895-010	10
	Phosphorus	ascorbic acid	HI3895-010	10
	Potassium	tetraphenylborate	HI3895-010	10
	pH	pH indicators	HI3895-010	10
HI3896	Nitrogen	Ned	HI3896-025	25
	Phosphorus	ascorbic acid	HI3896-025	25
	Potassium	tetraphenylborate	HI3896-025	25
	pH	pH indicators	HI3896-025	25
HI3896BP	Nitrogen	Ned	HI3896-025	25
	Phosphorus	ascorbic acid	HI3896-025	25
	Potassium	tetraphenylborate	HI3896-025	25
	pH	pH indicators	HI3896-025	25
	Buffer solution	-	HI70004P	25
	Buffer solution	-	HI70007P	25
	Buffer solution	-	HI70010P	25
	EC Calibration Standard	-	HI70031P	25
	TDS Calibration Standard	-	HI70032P	25
HI3897	Acidity, olive oil	titration with hydroxide	HI3897-010	10
HI3827	Alkalinity (as CaCO <sub>3</sub> )	acid titration	HI3811-100	110 avg.
	Hardness, total (as CaCO <sub>3</sub> )	EDTA titration	HI3812-100	100 avg.
	Chloride	mercuric nitrate titration	HI3815-100	110 avg.
	Sulfite (as Na <sub>2</sub> SO <sub>3</sub> )	titration	HI3822-100	110 avg.
	Phosphate	ascorbic acid	HI3833-050	50
	Buffer solution	-	HI70004P	25
	Buffer solution	-	HI70007P	25
	Buffer solution	-	HI70010P	25

CTK Code	Test Kit Parameter	Chemical Method	Reagent Code	# Tests
HI3899BP	Dissolved Oxygen	Winkler	HI3810-100	110 avg
	Alkalinity (as CaCO <sub>3</sub> )	phenolphthalein/bromphenol blue	HI3811-100	110 avg.
	Carbon Dioxide	phenolphthalein titration	HI3818-100	110 avg
	Acidity (as CaCO <sub>3</sub> )	methyl-orange/phenolphthalein	HI3820-100	110 avg
	Ammonia, Seawater (as NH <sub>3</sub> -N)	Nessler colorimetric	HI3826-025	25 avg
	Phosphate	ascorbic acid	HI3833-050	50
	Salinity	mercuric nitrate titration	HI3835-100	110 avg
	Nitrite (as NO <sub>2</sub> <sup>-</sup> -N)	chromotropic acid	HI3873-100	100
	Nitrate (as NO <sub>3</sub> <sup>-</sup> -N)	cadmium reduction	HI3874-100	100
	Buffer solution	-	HI70004P	25
	Buffer solution	-	HI70007P	25
	Buffer solution	-	HI70010P	25
	EC Calibration Standard	-	HI70031P	25
	EC Calibration Standard	-	HI7033M	1 bottle (230 mL)
HI38000	Sulfate	barium chloride	HI38000-10	100
HI38001	Sulfate LR/HR	barium chloride	HI38001-10	100
HI38017	Chlorine, free and total	DPD colorimetric	HI38017-200	200
HI38018	Chlorine, free	DPD colorimetric	HI38018-200	200
HI38020	Chlorine, free and total	DPD colorimetric	HI38020-200	200
HI38023	Chlorine, total, extended range	iodometric	HI38023-100	100
HI38033	Hardness, total (as CaCO <sub>3</sub> )	EDTA titration	HI38033-100	100
HI38039	Iron LR	phenanthroline colorimetric	HI38039-100	100
HI38040	Iron MR	phenanthroline colorimetric	HI38040-100	100
HI38041	Iron HR	phenanthroline colorimetric	HI38041-100	100
HI38050	Nitrate (soil + irrigation) (as NO <sub>3</sub> <sup>-</sup> -N)	cadmium reduction	HI38050-200	200
HI38054	Ozone	DPD	HI38054-100	100
HI38061	Phosphate	ascorbic acid	HI38061-100	100
HI38067	Silica HR (as SiO <sub>2</sub> )	heteropoly blue	HI38067-100	100
HI38074	Boron	boric acid	HI38074-100	100



**Introduction.....10.2**

- Product Spotlights..... 10.4
- Comparison Guides..... 10.6

**Benchtop .....10.8**

- iris® Spectrophotometer .....10.8
- Holmium Filter for iris .....10.21
- HI83300 Family Photometers .....10.22
  - Laboratory ..... 10.28
  - Aquaculture .....10.32
  - Boilers and Cooling Towers ..... 10.34
  - Environmental Analysis ..... 10.36
  - Nutrient Analysis ..... 10.38
  - Suction Lysimeter ..... 10.40
  - Pool and Spa Introduction ..... 10.41
  - Pools and Spas ..... 10.44
  - Water Conditioning ..... 10.46

**Portable.....10.48**

- HI97000 Series Introduction..... 10.48

- Single Parameter HI97000 Series .....10.53
- Multi-Parameter HI97000 Series..... 10.88
  - Marine Line.....10.88
  - Pool Line..... 10.96
- HI96000 Series Honey Color .....10.112

**Reagents .....10.114**

- Standard Reagents.....10.114
- CAL Check™ Kits .....10.115

**Photometers for Wine Applications .....10.116**

**Checker® HC Handheld Colorimeters ..... 10.122**

- Checker HC Introduction..... 10.122
- Checker HC Handheld Colorimeters..... 10.123
- Reagents ..... 10.152
- Accessories ..... 10.152

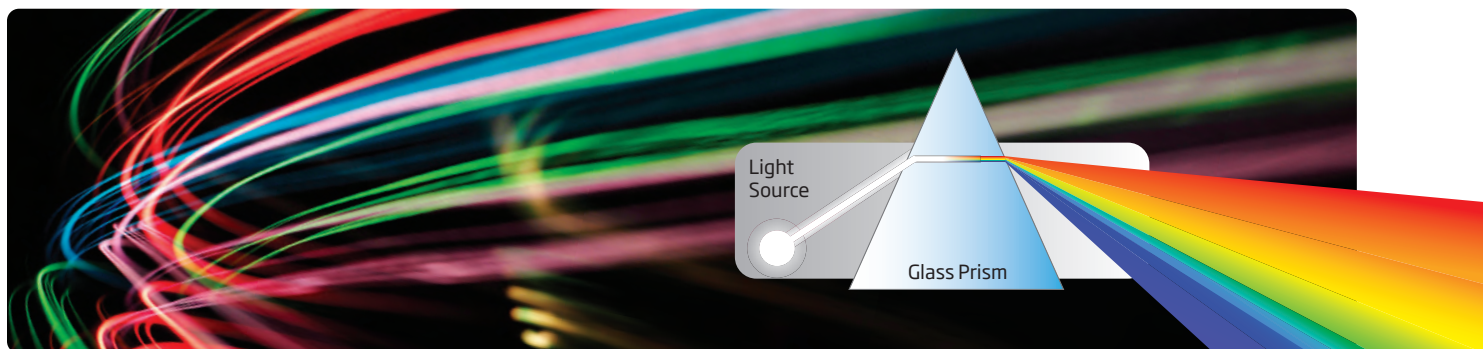

## Light and Color

Before entering into colorimetry, it is important to understand the relationship between light and color.

In simple terms, colors are dependent on light. We do not actually see colors rather, what we see as color is the effect of light shining on an object. When white light shines on an object, it may be reflected, absorbed, or transmitted. Glass transmits most of the light that comes into contact with it, thus it appears colorless. Snow reflects all of the light and appears white. A black cloth absorbs all light, and so appears black. A red piece of paper reflects red light better than it reflects other colors. Most objects appear colored because their chemical structure absorbs certain wavelengths of light and reflects others.

When discussing light, we are usually referring to white light. A thin line of light is called a ray; a beam is made up of many rays of light. When white light passes through a prism (a triangular transparent object) the colors that make up white light disperse into seven bands of color. These bands of color are called a spectrum. Seven colors constitute white light: red, orange, yellow, green, blue, indigo, and violet. In any spectrum, the bands of color are always organized in this order from left to right.

Suppose we shine a beam of white light at a substance that absorbs blue light. Since the blue component of the white light gets absorbed by the substance, the light that is transmitted is mostly yellow, the complementary color of blue. This yellow light reaches our eyes, and we “see” the substance as a yellow colored substance.

The color variation of a system that undergoes a change in concentration of some component is the basis of colorimetric analysis.

Wavelength (nm)	Color Absorbed	Color Observed
400	Violet	Yellow-green
435	Blue	Yellow
495	Green	Purple
560	Yellow	Blue
650	Orange	Greenish blue
800	Red	Bluish green

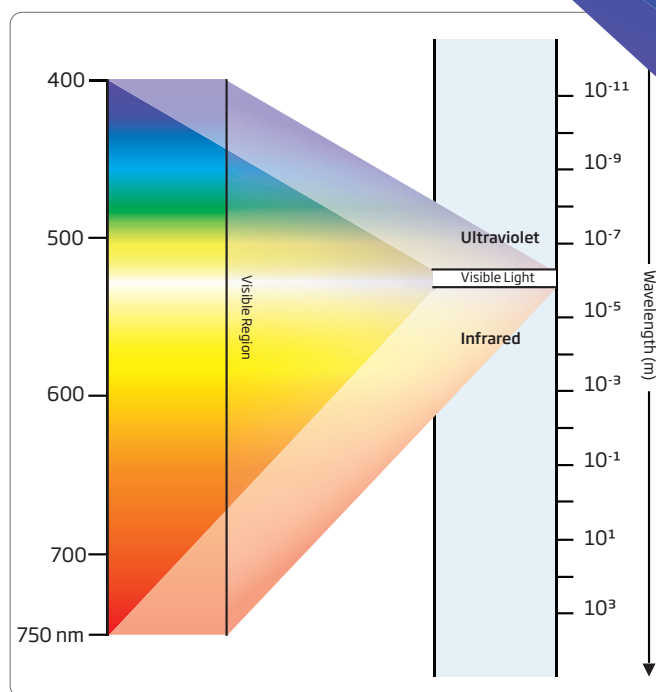

## Colorimetry

Colorimetry is simply the measurement of color. Colorimetry is the determination of the concentration of a substance by measurement of the relative absorption of light with respect to a known concentration of the substance. In visual colorimetry, natural or artificial white light is generally used as a light source and determinations are usually made with a simple instrument termed a colorimeter, or color comparator. When the eye is replaced by a photoelectric cell, the instrument is termed a photoelectric colorimeter.

A colorimetric analysis is based on the principle that many substances react with each other and form a color which can indicate the concentration of the substance to be measured. When a substance is exposed to a beam of light of intensity ( $I_0$ ) a portion of the radiation is absorbed by the substance's molecules and a radiation of intensity ( $I$ ) is emitted. This difference in intensity is used for the colorimetric determination.



The quantity of radiation absorbed is given by the Beer-Lambert Law:  $A = \log I_0$

Absorbance is also given by:  $A = \epsilon_{\lambda} \cdot C \cdot l$  where:

**A** is a dimensionless number

$\epsilon_{\lambda}$  the proportionality constant, is called the molar extinction coefficient or molar absorptivity; it is a constant for a given substance, provided the temperature and wavelength are constant [ $L/(\text{mol} \cdot \text{cm})$ ]

**C** concentration of the substance (mol/liter)

**l** optical distance light travels through sample (cm)

Therefore, the concentration (**C**) can be calculated from the absorbance of the substance determined by the emitted radiation (**I**), as the other factors are known.

A typical block diagram of a photometer is shown below:

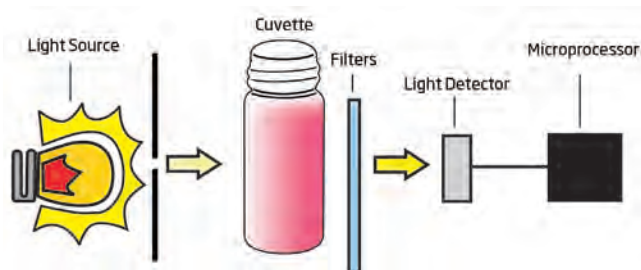

### Sources of light used by Hanna colorimeters:

**Tungsten lamp** an incandescent lamp having a tungsten filament

**LED** light emitting diode

The optical distance is measured by the dimension of the cuvette containing the sample. The photoelectric cell collects the radiation (**I**) emitted by the sample and converts it into an electric current, producing a potential in the mV range. The microprocessor uses this potential to convert the incoming value into the desired measuring unit and display it on the LCD.

In fact, the preparation of the solution to be measured occurs under known conditions, which are programmed into the meters microprocessor in the form of a calibration curve. This curve is used as a reference for each measurement. It is then possible to determine unknown concentrations of a sample by using a colorimetric reaction and the mV signal separated by a sensor in relation to the emitted intensity (**I**) (the color of the sample). By employing the calibration curve, one can determine the concentration of the sample that corresponds to the mV value.

Supposing that for one chemical substance there is a maximum absorbance at 610 nm. With the following graphs, you have one example of how the colorimeters are working to determine concentration:

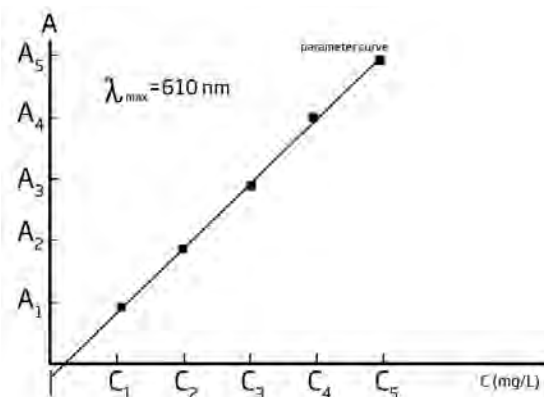
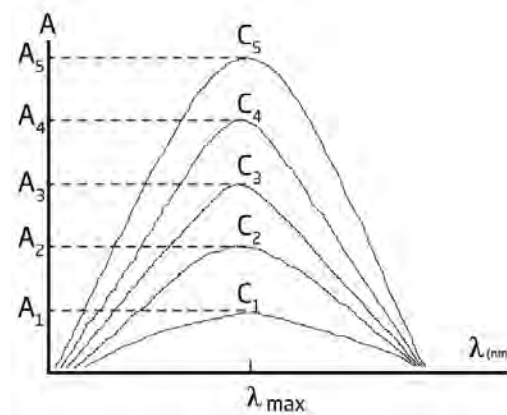

One example of an early colorimetric analysis is Nessler's method for ammonia, which was first proposed in 1856. Nessler found that adding an alkaline solution of HgI<sub>2</sub> and KI to a dilute solution of ammonia produced a yellow to reddish brown colloid with the color intensity proportional to the concentration of ammonia present. A comparison of the samples color for a series of standards was used to determine the concentration of ammonia. Equal volumes of the sample and standards were transferred to a set of tubes with flat bottoms. The tubes were placed in a rack equipped at the bottom with a reflecting surface, allowing light to pass through the solution. The colors of the samples and standards were compared by looking down through the solutions. A modified form of this method is used for the analysis of ammonia in water and wastewater.





## Spectrophotometer

*with split beam optical system, customizable methods and rechargeable battery*

iris® portable spectrophotometer is unlike any of the products we have created in the past. It is different from our photometers as it allows for measurement in the spectrum of all wavelengths of visible light and not just pre-specified wavelengths. Spectrophotometers work by isolating light at specific wavelengths from white light. This compact meter incorporates a number of features that facilitate both fantastic performance and exceptional usability.

See page 10.8



HI97115

## Marine Master Waterproof Wireless Multiparameter Photometer

*Measure pH, Alkalinity, Ammonia, Calcium, Magnesium, Nitrate LR, Nitrate HR, Nitrite ULR, and Phosphate ULR*

The HI97115 is a compact and versatile Marine multiparameter photometer designed for aquariums and marine biology applications. The HI97115 is suitable for field and bench measurements. The HI97115 can be used as a stand-alone photometer or can be connected to the Hanna Lab App with a compatible smart device via the integrated Bluetooth module.

See page 10.88

IP67  
waterproof



Hanna Lab App  
Compatible



HI83326

## Multiparameter Photometer

with Digital pH Electrode Input for Pool and Spa Applications

Made with the pool and spa industry in mind, the HI83326 benchtop photometer measures 12 different key water quality parameters using 14 different methods.



HI971044

## pH, Alkalinity, Free and Total Chlorine and Cyanuric Acid Portable Photometer

See page 10.96



HI783

## Marine Magnesium

Handheld Colorimeter

The HI783 Marine Magnesium Checker®HC is a handheld colorimeter that uses the Beer-Lambert principle to determine the concentration of magnesium colorimetrically. The HI783 is designed specifically to measure magnesium levels in a saltwater aquarium or in marine biology applications. The 1000 to 1800 ppm range is ideal for coral/fish or fish-only aquarium maintenance.

See page 10.133



HI784

## Marine Ammonia

Handheld Colorimeter

The HI784 Marine Ammonia Checker®HC is a handheld colorimeter that uses the Beer-Lambert principle to determine the concentration of ammonia colorimetrically. The HI784 is designed specifically to measure ammonia levels in a saltwater aquarium. The 0.00 to 2.50 ppm range is ideal for coral/fish or fish-only aquarium maintenance.

See page 10.124



Parameter	HI83300 Laboratory	HI83303 Aquaculture	HI83305 Boilers/Cooling Towers	HI83306 Environmental Analysis	HI83308 Water Conditioning	HI83325 Nutrient Analysis	HI83326 Pool Line, Pools and Spas
Alkalinity	•	•					•
Alkalinity, Marine	•	•					
Aluminum	•		•				
Ammonia Low Range	•	•	•	•	•	•	
Ammonia Medium Range	•	•	•	•	•	•	
Ammonia High Range	•	•	•	•	•	•	
Bromine	•		•				•
Calcium	•	•				•	
Calcium, Marine	•	•					
Chloride	•						
Chlorine Dioxide	•		•				•
Chlorine Dioxide, Rapid Method	•		•				•
Chlorine, Free	•	•	•	•	•		•
Chlorine, Free Ultra Low Range	•						
Chlorine, Total	•	•	•	•	•		•
Chlorine, Total Ultra Low Range	•						
Chlorine, Total Ultra High Range	•						
Chromium(VI) Low Range	•		•	•			
Chromium(VI) High Range	•		•	•			
Color of Water	•			•			
Copper Low Range	•	•	•	•	•		
Copper High Range	•	•	•	•	•		•
Cyanuric Acid	•			•			•
Fluoride Low Range	•				•		
Fluoride High Range	•						
Hardness, Calcium	•						•
Hardness, Magnesium	•						
Hardness, Total Low Range	•						
Hardness, Total Medium Range	•						
Hardness, Total High Range	•						
Hydrazine	•		•				
Iodine	•						
Iron Low Range	•		•		•		
Iron High Range	•		•		•		•
Iron (II) (Ferrous)	•		•				
Iron (II & III) (Ferrous and Ferric)	•					•	
Magnesium	•					•	
Manganese Low Range	•				•		
Manganese High Range	•				•		
Molybdenum	•		•	•	•		
Nickel Low Range	•			•	•		
Nickel High Range	•			•	•		
Nitrate	•	•	•	•	•	•	•
Nitrite Ultra Low Range, Marine	•	•					
Nitrite Low Range	•	•	•				
Nitrite High Range	•	•	•	•			
Oxygen, Dissolved	•	•	•	•	•		
Oxygen Scavengers (as Carbohydrazide)	•		•				
Oxygen Scavengers (as DEHA)	•		•				
Oxygen Scavengers (as Hydroquinone)	•		•				
Oxygen Scavengers (as Iso-ascorbic acid)	•		•				
Ozone	•						•
pH	•	•	•	•	•		•
Phosphate Ultra Low Range, Marine	•	•					
Phosphate Low Range	•	•	•	•	•		•
Phosphate High Range	•	•	•	•	•	•	
Potassium	•					•	
Silica Low Range	•		•	•	•		
Silica High Range	•		•				
Silver	•			•	•		
Sulfate	•					•	
Surfactants, Anionic	•						
Zinc	•		•	•	•		
Page	10.28	10.32	10.34	10.36	10.46	10.38	10.44

## Single Parameter Portable Photometers Guide

Parameter	Meter	Page	Parameter	Meter	Page	Parameter	Meter	Page
Aluminum	HI97712	10.53	Cyanide	HI97714	10.67	Nitrate, as Nitrogen	HI97728	10.78
Ammonia HR	HI97733	10.55	Cyanuric Acid	HI97722	10.68	Nitrite HR	HI97708	10.79
Ammonia MR	HI97715	10.54	Fluoride HR	HI97739	10.69	Nitrite LR	HI97707	10.79
Ammonia LR	HI97700	10.54	Fluoride LR	HI97729	10.69	Oxygen, Dissolved	HI97732	10.80
Anionic Surfactants	HI97769	10.56	Hardness, Ca	HI97720	10.70	Phosphate HR	HI97717	10.81
Bromine	HI97716	10.57	Hardness, Mg	HI97719	10.70	Phosphate LR	HI97713	10.81
Chloride	HI97753	10.58	Hardness, EPA	HI97735	10.71	Phosphorus	HI97706	10.82
Chlorine Dioxide	HI97738	10.59	Honey Color	HI96785	10.112	Potassium	HI97750	10.83
Chlorine Dioxide (Rapid)	HI97779	10.60	Hydrazine	HI97704	10.72	Silica HR	HI97770	10.84
Chlorine, Free ULR	HI97762	10.61	Iodine	HI97718	10.73	Silica LR	HI97705	10.84
Chlorine, Free	HI97701	10.62	Iron LR	HI97746	10.74	Silver	HI97737	10.85
Chlorine, Total ULR	HI97761	10.63	Iron HR	HI97721	10.74	Sulfate	HI97751	10.86
Chromium VI HR	HI97723	10.64	Manganese HR	HI97709	10.75	Zinc	HI97731	10.87
Chromium VI LR	HI97749	10.64	Manganese LR	HI97748	10.75			
Color of Water	HI97727	10.65	Molybdenum	HI97730	10.76			
Copper LR	HI97747	10.66	Nickel HR	HI97726	10.77			
Copper HR	HI97702	10.66	Nickel LR	HI97740	10.77			

## Multiparameter Portable Photometers Comparison Guides

	HI97115	HI97105	HI97101	HI97104 / HI971044	HI97725	HI97771	HI97736	HI97710	HI97711	HI97734	HI97741	HI97742	HI97752	HI97745
Alkalinity	.*	.*		.										
Ammonia	.*	.*												
Bromine			.											
Calcium	.*	.*												
Calcium HR													.	
Chlorine, Free			.	.	.			.	.					.
Chlorine, Free HR										.				
Chlorine, Free UHR						.								
Chlorine, Total			.	.	.			.	.					.
Chlorine, Total HR						.				.				
Chlorine, Total UHR						.								
Cyanuric Acid			.	.	.									
Hardness, Ca											.			
Hardness, Mg											.			
Hardness, Total							.				.			.
Iodine			.											
Iron LR			.								.	.		.
Magnesium	.*	.*												
Magnesium HR													.	
Manganese LR												.		
Nitrate LR	.*	.*												
Nitrate HR	.*	.*												
Nitrite ULR	.*	.*												
pH	.*	.*	.	.	.		.	.						.
Phosphate ULR	.*	.*												
Page	10.88	10.92	10.94	10.96	10.98	10.100	10.101	10.102	10.104	10.105	10.106	10.108	10.109	10.110

\* Marine

## Wine and Olive Oil Measurement Photometers

Concentration of Reducing Sugars in Wine	HI83746	10.116
Tartaric Acid in Wine	HI83748	10.118
Peroxide in Olive Oils	HI83730	10.120

The logo for 'iris' features the word in a lowercase, sans-serif font. Each letter is filled with a different color from the rainbow spectrum: 'i' is red, 'r' is orange, 'i' is yellow, 's' is green, and 's' is blue.

## Spectrophotometer

*with split beam optical system, customizable methods and rechargeable battery*

iris® portable spectrophotometer is unlike any of the products we have created in the past. It is different from our photometers as it allows for measurement in the spectrum of all wavelengths of visible light and not just pre-specified wavelengths. Spectrophotometers work by isolating light at specific wavelengths from white light. This compact meter incorporates a number of features that facilitate both fantastic performance and exceptional usability.

- Advanced split beam optical system
- Rechargeable li-ion battery
- User customizable methods



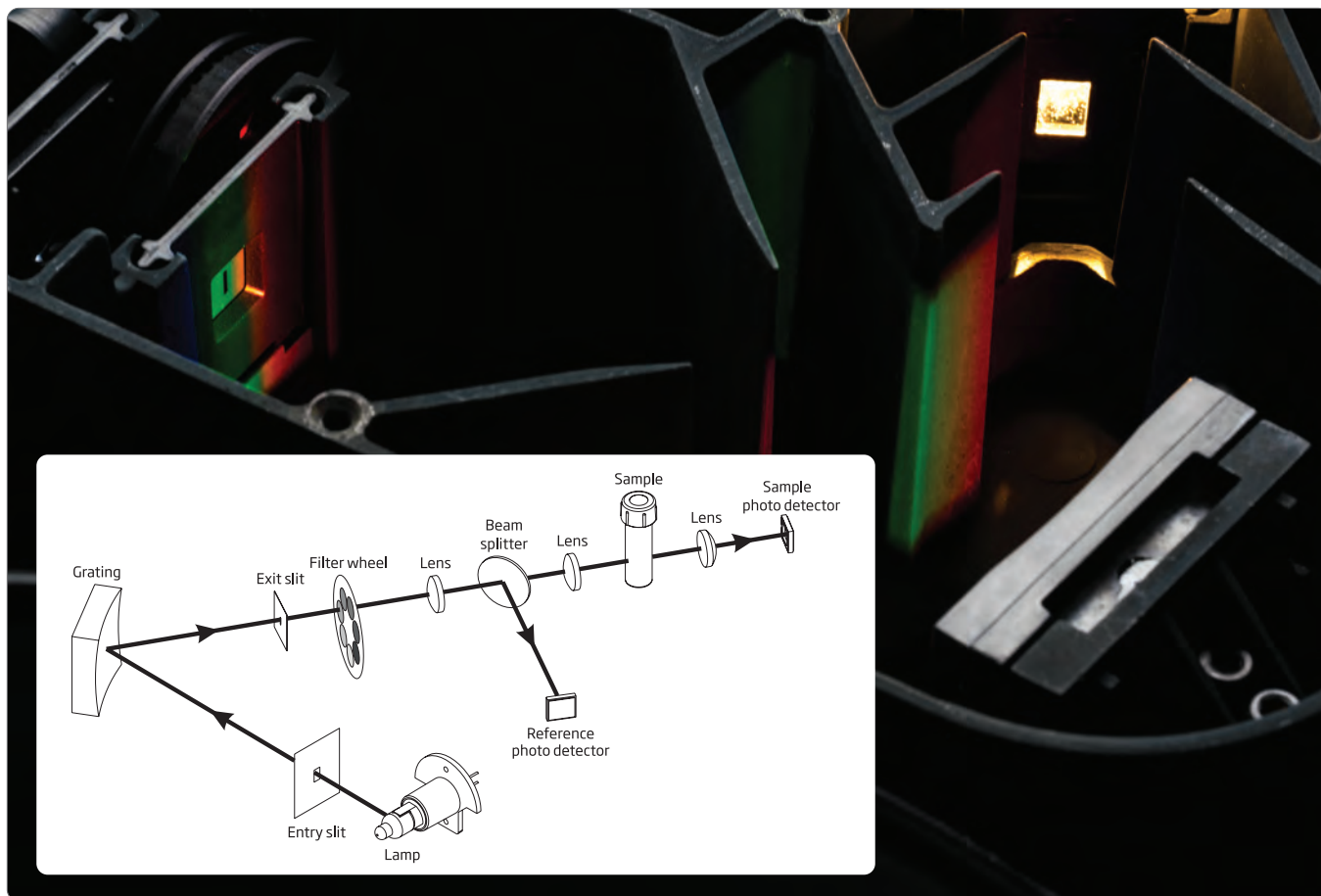

## Advanced Split-beam Optical System

In a spectrophotometer the optical system is the heart of the instrument. Ensuring that the optical system is built with the best design and highest quality materials will guarantee accurate readings and a long life for the meter. When developing this meter our research and development team paid special attention to details and combined many small improvements to a typical spectrophotometer design to create a portable meter with unprecedented performance.



### Replaceable Tungsten-Halogen Lamp

To be able to measure in a wide variety of wavelengths a broadband light source is necessary. In the iris® spectrophotometer this is accomplished by a tungsten-halogen lamp. As these lamps do not last indefinitely, it is necessary to change them throughout the life of the meter. The pre-alignment of the lighting fixture guarantees that the bulb is in the same position every time it is changed. This generates peace of mind as there is no need to worry about realigning the light source.



### Beam splitter

The beam splitter is added to the optical system for use with a reference detector to ensure that the measurement compensates for any drift in the light source. It works by splitting the light emitted by the tungsten lamp into two beams and sending one beam of light to the reference detector that measures intensity. If there are any fluctuations in the light source the meter detects this and compensates through a mathematical calculation. The reference detector also saves battery life and leads to improved speed of the meter as the lamp doesn't have to warm up prior to use.







### Concave grating

This element of the optical system is what generates the spectrum of light. When the light from the tungsten lamp hits the grating it is met with interference coatings that turn the polychromatic white light into a rainbow. This rainbow contains dispersed light at all wavelengths in the visible spectrum. The rotation of this grating is what allows for a specific wavelength to be selected. This ability is one of the biggest differences between a spectrophotometer and a photometer. The concave grating which accomplishes this is superior to other types of diffraction, such as prisms, as it minimizes stray light generated and has constant bandwidth. It also combines elements of the optical system that would typically be separate, for example if a flat grating was used a concave mirror would need to be added in order to refocus the light. The combination of these two pieces creates greater efficiency and a smaller optical system to yield a more compact portable meter.

### Narrow Bandwidth and High Resolution

Having a small bandwidth is necessary to accurately measure narrow peaks. The iris® spectrophotometer maintains a narrow bandwidth of 5 nm resulting in good spectral resolution. This leads to accurate measurement of sharp, narrow absorbance peaks. Additionally, the high resolution of 1 nm generates greater sensitivity as the wavelength is closer to where the sample absorbs the most light.

### Low stray light

A common problem in spectrophotometers is stray light. Stray light can be light which is outside the wavelength the meter is measuring or also light at the proper wavelength but from outside the meter. This leads to inaccurate readings as this light would not be absorbed by the sample but would still be detected by the meter. This is a problem that is typically hard to control. Due to the design of the optical system we are able to keep this potential issue to a minimum to improve the linearity and accuracy of readings.

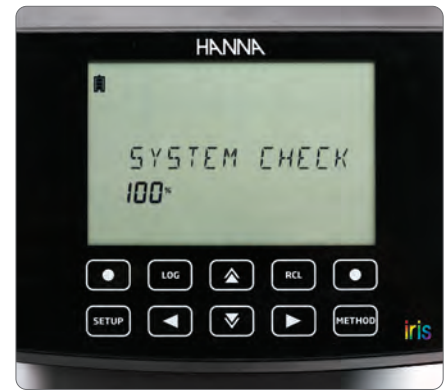

### System Check

Upon turning on the meter a performance check occurs to confirm that the light source is working properly and to calibrate the position of the grating. The grating calibration works by scanning for the "zero order" light reflecting off the grating. If any mechanical problems are present, the meter will display an alert. This feature establishes confidence in measurements knowing that the meter is always working properly without needing to run any additional tests.



### Universal Cuvette Holder and Auto-Recognition

The cuvette holder built into the meter holds both 22 mm round cuvettes and rectangular cuvettes with a 5 cm path length. Adapters for the cuvette holder are available to hold other 13 and 16 mm round cuvettes, and 10 mm square cuvettes. Rectangular cuvettes have longer path lengths which result in higher sensitivity in readings of low absorbance samples. Additionally, the meter permits the selection of the size of the cuvette used in custom user methods from the available sizes. For all methods, the programmed cuvette size is displayed on the screen to ensure the correct cuvette size is used, ensuring that the proper path length is being used by the meter when calculating measurements.

## Customized Methods

- Step-By-Step Method Creation
- Up to 10 calibration points
- Flexible calculations for multi wavelength methods

Creating a customized method is easy and intuitive. The HI801 guides you step-by-step through the process of creating your own custom method. The intuitive user interface will guide you through naming your method, setting the measurement wavelengths, creating reaction timers, and calibrating the method. Up to 10 points can be used to calibrate methods.

## User Interface

No one likes to work with difficult equipment, which is why we have worked hard to create an interface that makes the meter's operation seamless. The intuitive menu design and large LCD screen all make working with the meter a breeze. Get ready for your new favorite piece of lab equipment.

## Favorite Methods

Always have your most frequently used methods readily available with the favorite methods feature. Directly from the home screen is access to user-programmed favorite methods, saving time.

## Large High Contrast Custom LCD display

With a 6" display, the screen is large and easy to read. The high contrast makes every character on the display stand out even during outdoor use. The wide viewing angle allows for measurements to be seen from far away, so while working around the lab it is not necessary to hover over the meter to see the measurements.

## Capacitive touchpad

Maneuvering the menus and using the meter is effortless with the capacitive touchpad. Featuring dedicated buttons specifically for setup, logging data, recalling data, and methods allows for quick and easy access to these functions. There is a key beep feature that can be enabled or disabled, for audible feedback that the key was pressed. Additionally, the meter also still recognizes key touches even through gloves.



## General Features

When choosing a piece of equipment making sure the product has all required features for the intended purposes is critical. When building the iris® we included as many features as we could to aid in making this meter exceedingly versatile and convenient. From bare necessities such as long battery life and easy data logging and transfer, we have pushed the limits on seemingly basic features to make your life as easy as possible.



### Spectral range

The meter features a spectral range of 340nm to 900nm allowing for a wide selection of analytical methods. The flexibility of this range permits compliance with many methods from regulatory organizations and associations for a variety of applications.



### Pre-programmed Methods

Programmed in the meter are more than 80 commonly used methods for chemical analysis. Methods can easily be updated by transferring the file from a computer to the meter or by a flash drive. Up to 150 factory methods can be saved in the meter and some chemical parameters have the option to switch between different chemical forms. Finding the product codes to order additional reagents is easy as the meter provides the appropriate reagent codes for each programmed method.



### User methods

The ability to program up to 100 personal methods into the meter creates both versatility and customization. Methods can include up to 10 calibration points, 5 different wavelengths (which can be used simultaneously), and permits the use of 5 reaction timers. These features allow for many variations to be implemented into methods. Compared to a photometer there is no longer a limitation by factory methods. If a certain parameter is not offered or a modification to a pre-programmed method is required, the meter can be customized to suit your needs.



### Battery operated

The meter features a rechargeable lithium ion battery that lasts for approximately 3,000 measurements. Lasting well over a day of use in the field there is no need to worry about the battery life while out working without a power supply. The meter can be quickly recharged with a dedicated fast charging adapter.



### Data Logging and Transfer

Transferring data from a meter should always be simple and straightforward. Impressively the meter can store up to 9999 measurements in the memory. At any time data can be transferred to a PC or Mac as either a CSV or PDF file. No software is required, simply plug in a flash drive or plug it into a computer and export the data. The ability to save data as a PDF ensures higher integrity of the data as it cannot be easily changed. Additionally, a meter ID and a sample ID can be programmed to be saved along with logged measurements. With technical equipment wide-spread connection compatibility can often be an issue, which is why the iris features USB ports for both flash drive and a direct computer connection. Connectivity with a USB-A port to a flash drive can be used to transfer logged measurements from the meter and also to transfer method updates onto the meter. The USB-B port is used for a direct connection to a computer specifically for transferring logged data.

## HI801 iris® Parameter Specifications

Parameter	Range	Resolution	Accuracy	Wavelength	Cuvette Type	Method	Method ID	Reagent Code
Alkalinity	0 to 500 mg/L (as CaCO <sub>3</sub> )	1 mg/L	±5 mg/L ±5% of reading at 25 °C	610 nm	22 mm diameter	Bromocresol Green	#001	<b>HI775-26</b> Reagents for 25 tests
Alkalinity, Marine	0 to 300 mg/L (as CaCO <sub>3</sub> )	1 mg/L	±5 mg/L ±5% of reading at 25 °C	610 nm	22 mm diameter	Bromocresol Green	#002	<b>HI755-26</b> Reagents for 25 tests
Aluminum	0.00 to 1.00 mg/L (as Al <sup>3+</sup> )	0.01 mg/L	±0.04 mg/L ±4% of reading at 25 °C	530 nm	22 mm diameter	Adaptation of the Aluminon Method	#003	<b>HI93712-01</b> Reagents for 100 tests <b>HI93712-03</b> Reagents for 300 tests
Ammonia Low Range	0.00 to 3.00 mg/L (as NH <sub>3</sub> -N)	0.01 mg/L	±0.04 mg/L ±4% of reading at 25 °C	425 nm	16 mm diameter	Adaptation of the ASTM Manual of Water and Environmental Technology, D1426 Nessler Method	#004	<b>HI93700-01</b> Reagents for 100 tests <b>HI93700-03</b> Reagents for 300 tests
Ammonia Low Range (13 mm Vial)	0.00 to 3.00 mg/L (as NH <sub>3</sub> -N)	0.01 mg/L	±0.10 mg/L or ±5% of reading at 25 °C, whichever is greater	425 nm	13 mm diameter	Adaptation of the ASTM Manual of Water and Environmental Technology, D1426 Nessler Method	#005	<b>HI93764A-25</b> Reagents for 25 tests
Ammonia Medium Range	0.00 to 10.00 mg/L (as NH <sub>3</sub> -N)	0.01 mg/L	±0.05 mg/L ±5% of reading at 25 °C, whichever is greater	425 nm	16 mm diameter	Adaptation of the ASTM Manual of Water and Environmental Technology, D1426, Nessler Method	#006	<b>HI93715-01</b> Reagents for 100 tests <b>HI93715-03</b> Reagents for 300 tests
Ammonia High Range	0.0 to 100.0 mg/L (as NH <sub>4</sub> <sup>+</sup> )	0.1 mg/L	±0.5 mg/L ±5% of reading at 25 °C	425 nm	16 mm diameter	Adaptation of the ASTM Manual of Water and Environmental Technology, D1426, Nessler Method	#007	<b>HI93733-01</b> Reagents for 100 tests <b>HI93733-03</b> Reagents for 300 tests
Ammonia High Range (13 mm Vial)	0.0 to 100.0 mg/L (as NH <sub>3</sub> -N)	0.1 mg/L	±1.0 mg/L or ±5% of reading at 25 °C, whichever is greater	430 nm	13 mm diameter	Adaptation of the ASTM Manual of Water and Environmental Technology, D1426 Nessler Method	#008	<b>HI93764B-25</b> Reagents for 25 tests
Bromine	0.00 to 10.00 mg/L (as Br <sub>2</sub> )	0.01 mg/L	±0.08 mg/L ±3% of reading at 25 °C	525 nm	22 mm diameter	Adaptation of the Standard Methods for the Examination of Water and Wastewater, 18th Edition, DPD Method	#009	<b>HI93716-01</b> Reagents for 100 tests <b>HI93716-03</b> Reagents for 300 tests
Calcium	0 to 400 mg/L (as Ca <sup>2+</sup> )	1 mg/L	±10 mg/L ±5% of reading at 25 °C	466 nm	22 mm diameter	Adaptation of the Oxalate Method	#010	<b>HI937521-01</b> Reagents for 50 tests <b>HI937521-03</b> Reagents for 150 tests
Calcium, Marine	200 to 600 mg/L (as Ca <sup>2+</sup> )	1 mg/L	±5% of reading at 25 °C	610 nm	16 mm diameter	Adaptation of the Zincon Method	#011	<b>HI758-26</b> Reagents for 25 tests
Chloride	0.0 to 20.0 mg/L (as Cl <sup>-</sup> )	0.1 mg/L	±0.5 mg/L ±5% of reading at 25 °C	455 nm	22 mm diameter	Adaptation of the Mercury (II) Thiocyanate Method	#012	<b>HI93753-01</b> Reagents for 100 tests <b>HI93753-03</b> Reagents for 300 tests
Chlorine Dioxide	0.00 to 2.00 mg/L (as ClO <sub>2</sub> )	0.01 mg/L	±0.10 mg/L ±5% of reading at 25 °C	575 nm	22 mm diameter	Adaptation of the Chlorophenol Red Method	#013	<b>HI93738-01</b> Reagents for 100 tests <b>HI93738-03</b> Reagents for 300 tests
Chlorine Dioxide (Rapid)	0.00 to 2.00 mg/L (as ClO <sub>2</sub> )	0.01 mg/L	±0.10 mg/L ±5% of reading at 25 °C	525 nm	22 mm diameter	Adaptation of Standard Methods for the Examination of Water and Wastewater, 18th Edition, 4500 ClO <sub>2</sub> D	#086	<b>HI96779-01</b> Reagents for 100 tests <b>HI96779-03</b> Reagents for 300 tests
Chlorine, Free Ultra Low Range	0.000 to 0.500 mg/L (as Cl <sub>2</sub> )	0.001 mg/L	±0.020 mg/L ±3% of reading at 25 °C	525 nm	22 mm diameter	Adaptation of the EPA DPD Method 330.5	#014	<b>HI95762-01</b> Reagents for 100 tests <b>HI95762-03</b> Reagents for 300 tests
Chlorine, Free Low Range (Powder Reagent)	0.00 to 5.00 mg/L (as Cl <sub>2</sub> )	0.01 mg/L	±0.03 mg/L ±3% of reading at 25 °C	525 nm	22 mm diameter	Adaptation of the EPA DPD Method 330.5	#015	<b>HI93701-01</b> Reagents for 100 tests <b>HI93701-03</b> Reagents for 300 tests
Chlorine, Free Low Range (Liquid Reagent)	0.00 to 5.00 mg/L (as Cl <sub>2</sub> )	0.01 mg/L	±0.03 mg/L ±3% of reading at 25 °C	525 nm	22 mm diameter	Adaptation of the EPA DPD Method 330.5	#016	<b>HI93701-F</b> Reagents for 300 tests (liquid)
Chlorine, Free High Range	0.00 to 10.00 mg/L (as Cl <sub>2</sub> )	0.01 mg/L	±0.03 mg/L ±3% of reading at 25 °C	525 nm	22 mm diameter	Adaptation of the EPA DPD Method 330.5	#017	<b>HI93734-01</b> Reagents for 100 tests <b>HI93734-03</b> Reagents for 300 tests

Parameter	Range	Resolution	Accuracy	Wavelength	Cuvette Type	Method	Method ID	Reagent Code
Chlorine, Total Ultra Low Range	0.000 to 0.500 mg/L (as Cl <sub>2</sub> )	0.001 mg/L	±0.020 mg/L ±3% of reading at 25 °C	525 nm	22 mm diameter	Adaptation of the EPA DPD Method 330.5	#018	<b>HI95761-01</b> Reagents for 100 tests <b>HI95761-03</b> Reagents for 300 tests
Chlorine, Total Low Range (Powder Reagent)	0.00 to 5.00 mg/L (as Cl <sub>2</sub> )	0.01 mg/L	±0.03 mg/L ±3% of reading at 25 °C	525 nm	22 mm diameter	Adaptation of the EPA DPD Method 330.5	#019	<b>HI93711-01</b> Reagents for 100 tests (powder) <b>HI93711-03</b> Reagents for 300 tests (powder)
Chlorine, Total Low Range (Liquid Reagent)	0.00 to 5.00 mg/L (as Cl <sub>2</sub> )	0.01 mg/L	±0.03 mg/L ±3% of reading at 25 °C	525 nm	22 mm diameter	Adaptation of the EPA DPD Method 330.5	#020	<b>HI93701-T</b> Reagents for 300 tests (liquid)
Chlorine, Total High Range	0.00 to 10.00 mg/L (as Cl <sub>2</sub> )	0.01 mg/L	±0.03 mg/L ±3% of reading at 25 °C	525 nm	22 mm diameter	Adaptation of the EPA DPD Method 330.5	#021	<b>HI93734-01</b> Reagents for 100 tests <b>HI93734-03</b> Reagents for 300 tests
Chlorine, Total Ultra High Range	0 to 500 mg/L (as Cl <sub>2</sub> )	1 mg/L	±3 mg/L ±3% of reading at 25 °C	525 nm	22 mm diameter	Adaptation of the Standard Methods for Examination of Water and Wastewater, 20th Edition, 4500-Cl	#022	<b>HI95771-01</b> Reagents for 100 tests <b>HI95771-03</b> Reagents for 300 tests
Chromium (VI) Low Range	0 to 300 µg/L (as Cr(VI))	1 µg/L	±10 µg/L ±4% of reading at 25 °C	535 nm	22 mm diameter	Adaptation of the ASTM Manual of Water and Environmental Technology, D1687 Diphenylcarbohydrazide Method	#023	<b>HI93749-01</b> Reagents for 100 tests <b>HI93749-03</b> Reagents for 300 tests
Chromium (VI) High Range	0 to 1000 µg/L (as Cr(VI))	1 µg/L	±5 µg/L ±4% of reading at 25 °C	535 nm	22 mm diameter	Adaptation of the ASTM Manual of Water and Environmental Technology, D1687-92, Diphenylcarbohydrazide Method	#024	<b>HI93723-01</b> Reagents for 100 tests <b>HI93723-03</b> Reagents for 300 tests
Chromium (VI)/Total (13 mm Vial)	0 to 1000 µg/L (as Cr)	1 µg/L	±10 µg/L ± 3% of reading	525 nm	13 mm diameter	Adaptation of the Standard Methods of the Examination of Water and Wastewater, 22nd Edition, 3500-Cr, Diphenylcarbazide Method	#087	<b>HI96781-25</b> Reagents for 25 tests
Chemical Oxygen Demand Low Range EPA (13 mm Vial)	0 to 150 mg/L (as O <sub>2</sub> )	1 mg/L	±5 mg/L or ±4% of reading at 25 °C, whichever is greater	420 nm	13 mm diameter	Adaptation of the EPA 410.4 Approved Method for the COD Determination on Surface Waters and Wastewaters	#025	<b>HI93754A-25</b> Reagents for 24 tests
Chemical Oxygen Demand Low Range Mercury Free (13 mm Vial)	0 to 150 mg/L (as O <sub>2</sub> )	1 mg/L	±5 mg/L or ±4% of reading at 25 °C, whichever is greater	420 nm	13 mm diameter	Dichromate Mercury Free	#026	<b>HI93754D-25</b> Reagents for 24 tests
Chemical Oxygen Demand Low Range ISO (13 mm Vial)	0 to 150 mg/L (as O <sub>2</sub> )	1 mg/L	±5 mg/L or ±4% of reading at 25 °C, whichever is greater	420 nm	13 mm diameter	Dichromate ISO	#027	<b>HI93754F-25</b> Reagents for 24 tests
Chemical Oxygen Demand Medium Range EPA (13 mm Vial)	0 to 1500 mg/L (as O <sub>2</sub> )	1 mg/L	±15 mg/L or ±3% of reading at 25 °C, whichever is greater	610 nm	13 mm diameter	Adaptation of the EPA 410.4 Approved Method for the COD Determination on Surface Waters and Wastewaters	#028	<b>HI93754B-25</b> Reagents for 24 tests
Chemical Oxygen Demand Medium Range Mercury Free (13 mm Vial)	0 to 1500 mg/L (as O <sub>2</sub> )	1 mg/L	±15 mg/L or ±3% of reading at 25 °C, whichever is greater	610 nm	13 mm diameter	Dichromate Mercury Free	#029	<b>HI93754E-25</b> Reagents for 24 tests
Chemical Oxygen Demand Medium Range ISO (13 mm Vial)	0 to 1000 mg/L (as O <sub>2</sub> )	1 mg/L	±15 mg/L or ±3% of reading at 25 °C, whichever is greater	610 nm	13 mm diameter	Dichromate ISO	#030	<b>HI93754G-25</b> Reagents for 24 tests
Chemical Oxygen Demand High Range EPA (13 mm Vial)	0 to 15000 mg/L (as O <sub>2</sub> )	1 mg/L	±150 mg/L or ±2% of reading at 25 °C, whichever is greater	610 nm	13 mm diameter	Adaptation of the EPA 410.4 Approved Method for the COD Determination on Surface Waters and Wastewaters	#031	<b>HI93754C-25</b> Reagents for 24 tests
Chemical Oxygen Demand Ultra High Range (13 mm Vial)	0.0 to 60.0 ppt (as O <sub>2</sub> )	0.1 ppt	±0.5 ppt ±3% of reading @ 25°C	610 nm	13 mm diameter	Adaptation of the EPA 410.4 Approved Method for the COD Determination on Surface Waters and Wastewaters	#088	<b>HI93754J-25</b> Reagents for 24 tests

Parameter	Range	Resolution	Accuracy	Wavelength	Cuvette Type	Method	Method ID	Reagent Code
Color of Water	0 to 500 PCU (Platinum Cobalt Units)	1 PCU	±10 PCU ±5% of reading at 25 °C	460 nm	22 mm diameter	Adaptation of the Standard Methods for the Examination of Water and Wastewater, 18th Edition, Colorimetric Platinum Cobalt Method	#032	-
Copper Low Range	0 to 1500 µg/L (as Cu)	1 µg/L	±10 µg/L ±5% of reading at 25 °C	575 nm	22 mm diameter	Adaptation of the EPA Method	#033	<b>HI95747-01</b> Reagents for 100 tests <b>HI95747-03</b> Reagents for 300 tests
Copper High Range	0.00 to 5.00 mg/L (as Cu)	0.01 mg/L	±0.02 mg/L ±4% of reading at 25 °C	560 nm	22 mm diameter	Adaptation of the EPA Method	#034	<b>HI93702-01</b> Reagents for 100 tests <b>HI93702-03</b> Reagents for 300 tests
Cyanide	0.000 to 0.200 mg/L (as CN <sup>-</sup> )	0.001 mg/L	±0.005 mg/L ±3% of reading at 25 °C	610 nm	22 mm diameter	Pyridine-Pyrazalone	#035	<b>HI93714-01</b> Reagents for 100 tests <b>HI93714-03</b> Reagents for 300 tests
Cyanuric Acid	0 to 100 mg/L (as CYA)	1 mg/L	±1 mg/L ±15% of reading at 25 °C	525 nm	22 mm diameter	Adaptation of the Turbidimetric Method	#036	<b>HI93722-01</b> Reagents for 100 tests <b>HI93722-03</b> Reagents for 300 tests
Fluoride Low Range	0.00 to 2.00 mg/L (as F <sup>-</sup> )	0.01 mg/L	±0.03 mg/L ±3% of reading at 25 °C	575 nm	22 mm diameter	Adaptation of the Standard Methods for the Examination of Water and Wastewater, 18th Edition, SPADNS Method	#037	<b>HI93729-01</b> Reagents for 100 tests <b>HI93729-03</b> Reagents for 300 tests
Fluoride High Range	0.0 to 20.0 mg/L (as F <sup>-</sup> )	0.1 mg/L	±0.5 mg/L ±3% of reading at 25 °C	575 nm	22 mm diameter	Adaptation of the Standard Methods for the Examination of Water and Wastewater, 18th Edition, SPADNS Method	#038	<b>HI93739-01</b> Reagents for 100 tests <b>HI93739-03</b> Reagents for 300 tests
Hardness, Calcium	0.00 to 2.70 mg/L (as CaCO <sub>3</sub> )	0.01 mg/L	±0.08 mg/L ±4% of reading at 25 °C	523 nm	22 mm diameter	Adaptation of the Standard Methods for the Examination of Water and Wastewater, 18th Edition, Calmagite Method	#039	<b>HI93720-01</b> Reagents for 100 tests <b>HI93720-03</b> Reagents for 300 tests
Hardness, Magnesium	0.00 to 2.00 mg/L (as CaCO <sub>3</sub> )	0.01 mg/L	±0.11 mg/L ±5% of reading at 25 °C	523 nm	22 mm diameter	Adaptation of the Standard Methods for the Examination of Water and Wastewater, 18th Edition, EDTA Colorimetric Method	#040	<b>HI93719-01</b> Reagents for 100 tests <b>HI93719-03</b> Reagents for 300 tests
Hardness, Total Low Range	0 to 250 mg/L (as CaCO <sub>3</sub> )	1 mg/L	±5 mg/L ±4% of reading at 25 °C	466 nm	22 mm diameter	Adaptation of the EPA Method 130.1	#041	<b>HI93735-00</b> Reagents for 100 tests (LR) <b>HI93735-0</b> Reagents for 300 tests (LR - 100 tests, MR - 100 tests, HR - 100 tests)
Hardness, Total Medium Range	200 to 500 mg/L (as CaCO <sub>3</sub> )	1 mg/L	±7 mg/L ±3% of reading at 25 °C	466 nm	22 mm diameter	Adaptation of the EPA Method 130.1	#042	<b>HI93735-01</b> Reagents for 100 tests (MR) <b>HI93735-0</b> Reagents for 300 tests (LR - 100 tests, MR - 100 tests, HR - 100 tests)
Hardness, Total High Range	400 to 750 mg/L (as CaCO <sub>3</sub> )	1 mg/L	±10 mg/L ±2% of reading at 25 °C	466 nm	22 mm diameter	Adaptation of the EPA Method 130.1	#043	<b>HI93735-02</b> Reagents for 100 tests (HR) <b>HI93735-0</b> Reagents for 300 tests (LR - 100 tests, MR - 100 tests, HR - 100 tests)
Hydrazine	0 to 400 µg/L (as N <sub>2</sub> H <sub>4</sub> )	1 µg/L	±3 µg/L ±3% of reading at 25 °C	466 nm	22 mm diameter	Adaptation of the ASTM Manual of Water and Environmental Technology, Method D1385, p-Dimethylaminobenzaldehyde Method	#044	<b>HI93704-01</b> Reagents for 100 tests <b>HI93704-03</b> Reagents for 300 tests
Iodine	0.0 to 12.5 mg/L (as I <sub>2</sub> )	0.1 mg/L	±0.1 mg/L ±5% of reading at 25 °C	525 nm	22 mm diameter	Adaptation of the Standard Methods for the Examination of Water and Wastewater, 18th Edition, DPD Method	#045	<b>HI93718-01</b> Reagents for 100 tests <b>HI93718-03</b> Reagents for 300 tests

Parameter	Range	Resolution	Accuracy	Wavelength	Cuvette Type	Method	Method ID	Reagent Code
Iron Low Range	0.000 to 1.600 mg/L (as Fe)	0.001 mg/L	±0.010 mg/L ±8% of reading at 25 °C	575 nm	22 mm diameter	Adaptation of the TPTZ Method	#046	<b>HI93746-01</b> Reagents for 50 tests <b>HI93746-03</b> Reagents for 150 tests
Iron High Range	0.00 to 5.00 mg/L (as Fe)	0.01 mg/L	±0.04 mg/L ±2% of reading at 25 °C	525 nm	22 mm diameter	Adaptation of Standard Methods for the Examination of Water and Wastewater, 23rd Edition, 3500-Fe B, Phenanthroline Method	#047	<b>HI93721-01</b> Reagents for 100 tests <b>HI93721-03</b> Reagents for 300 tests
Iron (II) (Ferrous)	0.00 to 6.00 mg/L (as Fe <sup>2+</sup> )	0.01 mg/L	±0.10 mg/L ±2% of reading at 25 °C	525 nm	22 mm diameter	Adaptation of Standard Methods for the Examination of Water and Wastewater, 23rd Edition, 3500-Fe B, Phenanthroline Method	#089	<b>HI96776-01</b> Reagents for 100 tests <b>HI96776-03</b> Reagents for 300 tests
Iron (13 mm Vial)	0.00 to 6.00 mg/L (as Fe)	0.01 mg/L	±0.10 mg/L or ±3% of reading at 25°C	525 nm	13 mm diameter	Adaptation of Standard Methods for the Examination of Water and Wastewater, 23rd Edition, 3500-Fe B, Phenanthroline Method	#096	<b>HI96786-25</b> Reagents for 25 tests
Iron Total (13 mm Vial)	0.00 to 7.00 mg/L (as Fe)	0.01 mg/L	±0.20 mg/L or ±3% of reading, whichever is greater	525 nm	13 mm diameter	Adaptation of Standard Methods for the Examination of Water and Wastewater, 23rd Edition, 3500-Fe B, Phenanthroline Method	#090	<b>HI96778-25</b> Reagents for 25 tests
Magnesium	0 to 150 mg/L (as Mg <sup>2+</sup> )	1 mg/L	±5 mg/L ±3% of reading at 25 °C	466 nm	22 mm diameter	Adaptation of the Calmagite Method	#048	<b>HI937520-01</b> Reagents for 50 tests <b>HI937520-03</b> Reagents for 150 tests
Manganese Low Range	0 to 300 µg/L (as Mn)	1 µg/L	±7 µg/L ±3% of reading at 25 °C	560 nm	22 mm diameter	Adaptation of the PAN Method	#049	<b>HI93748-01</b> Reagents for 50 tests <b>HI93748-03</b> Reagents for 150 tests
Manganese High Range	0.0 to 20.0 mg/L (as Mn)	0.1 mg/L	±0.2 mg/L ±3% of reading at 25 °C	525 nm	22 mm diameter	Adaptation of the Standard Methods for the Examination of Water and Wastewater, 18th Edition, Periodate Method	#050	<b>HI93709-01</b> Reagents for 100 tests <b>HI93709-03</b> Reagents for 300 tests
Maple Syrup	0.00 to 100.00 %T	0.01 %T	±3% of reading at 25 °C	560 nm	10 mm diameter	Direct Measure	#051	<b>HI93703-57</b> Glycerol (4 pcs.), 30 mL
Molybdenum	0.0 to 40.0 mg/L (as Mo <sup>6+</sup> )	0.1 mg/L	±0.3 mg/L ±5% of reading at 25 °C	420 nm	22 mm diameter	Adaptation of the Mercaptoacetic Acid Method	#052	<b>HI93730-01</b> Reagents for 100 tests <b>HI93730-03</b> Reagents for 300 tests
Nickel Low Range	0.000 to 1.000 mg/L (as Ni)	0.001 mg/L	±0.010 mg/L ±7% of reading at 25 °C	565 nm	16 mm diameter	Adaptation of the PAN Method	#053	<b>HI93740-01</b> Reagents for 50 tests <b>HI93740-03</b> Reagents for 150 tests
Nickel High Range	0.00 to 7.00 ppt (as Ni)	0.01 ppt	±0.07 ppt ±4% of reading at 25 °C	575 nm	22 mm diameter	Adaptation of the Photometric Method	#054	<b>HI93726-01</b> Reagents for 100 tests <b>HI93726-03</b> Reagents for 300 tests
Nitrate	0.0 to 30.0 mg/L (as NO <sub>3</sub> <sup>-</sup> -N)	0.1 mg/L	±0.5 mg/L ±10% of reading at 25 °C	525 nm	22 mm diameter	Adaptation of the Cadmium Reduction Method	#055	<b>HI93728-01</b> Reagents for 100 tests <b>HI93728-03</b> Reagents for 300 tests
Nitrate Chromotropic Acid (13 mm Vial)	0.0 to 30.0 mg/L (as NO <sub>3</sub> <sup>-</sup> -N)	0.1 mg/L	±1.0 mg/L or ±3% of reading at 25 °C, whichever is greater	410 nm	13 mm diameter	Chromotropic Acid Method	#056	<b>HI93766-50</b> Reagents for 50 tests
Nitrite, Marine Ultra Low Range	0 to 200 µg/L (as NO <sub>2</sub> <sup>-</sup> -N)	1 µg/L	±8 µg/L ±4% of reading at 25 °C	480 nm	22 mm diameter	Adaptation of the EPA Diazotization Method 354.1	#057	<b>HI764-25</b> Reagents for 25 tests
Nitrite Low Range	0 to 600 µg/L (as NO <sub>2</sub> <sup>-</sup> -N)	1 µg/L	±20 µg/L ±4% of reading at 25 °C	480 nm	22 mm diameter	Adaptation of the EPA Diazotization Method 354.1	#058	<b>HI93707-01</b> Reagents for 100 tests <b>HI93707-03</b> Reagents for 300 tests
Nitrite Low Range (13 mm Vial)	0 to 600 µg/L (as NO <sub>2</sub> <sup>-</sup> -N)	1 µg/L	±10 µg/L ±3% of reading at 25°C, whichever is greater	525 nm	13 mm diameter	Adaptation of the Standard Method for the Examination of Water and Wastewater, 23rd Edition, 4500B Diazotization Method, Nitrogen Nitrite	#091	<b>HI96783-25</b> Reagents for 25 tests

Parameter	Range	Resolution	Accuracy	Wavelength	Cuvette Type	Method	Method ID	Reagent Code
Nitrite Medium Range (13 mm Vial)	0.00 to 6.00 mg/L (as NO <sub>2</sub> <sup>-</sup> -N)	0.01 mg/L	±0.10 mg/L ± 3% of reading at 25 °C	525 nm	13 mm diameter	Adaptation of the Standard Method for the Examination of Water and Wastewater, 23rd Edition, 4500B Diazotization Method, Nitrogen Nitrite	#092	<b>HI96784-25</b> Reagents for 25 tests
Nitrite High Range	0 to 150 mg/L (as NO <sub>2</sub> <sup>-</sup> )	1 mg/L	±4 mg/L ±4% of reading at 25 °C	575 nm	22 mm diameter	Adaptation of the Ferrous Sulfate Method	#059	<b>HI93708-01</b> Reagents for 100 tests <b>HI93708-03</b> Reagents for 300 tests
Nitrogen, Total Low Range (13 mm Vial)	0.0 to 25.0 mg/L (as N)	0.1 mg/L	±1.0 mg/L or ±5% of reading at 25 °C, whichever is greater	420 nm	13 mm diameter	Chromotropic Acid Method	#060	<b>HI93767A-50</b> Reagents for up to 49 tests
Nitrogen, Total High Range (13 mm Vial)	10 to 150 mg/L (as N)	1 mg/L	±3 mg/L or ±4% of reading at 25 °C, whichever is greater	420 nm	13 mm diameter	Chromotropic Acid Method	#061	<b>HI93767B-50</b> Reagents for up to 49 tests
Oxygen, Dissolved	0.0 to 10.0 mg/L (as O <sub>2</sub> )	0.1 mg/L	±0.4 mg/L ±3% of reading at 25 °C	466 nm	22 mm diameter	Adaptation of the Standard Methods for the Examination of Water and Wastewater, 18th Edition, Azide Modified Winkler Method	#062	<b>HI93732-01</b> Reagents for 100 tests <b>HI93732-03</b> Reagents for 300 tests
Oxygen Scavengers (Carbohydrazide)	0.00 to 1.50 mg/L (as Carbohydrazide)	0.01 mg/L	±0.02 mg/L ±3% of reading at 25 °C	575 nm	22 mm diameter	Adaptation of the Iron Reduction Method	#063	<b>HI96773-01</b> Reagents for 50 tests <b>HI96773-03</b> Reagents for 150 tests
Oxygen Scavengers (Diethylhydroxylamine) (DEHA)	0 to 1000 µg/L (as DEHA)	1 µg/L	±5 µg/L ±5% of reading at 25 °C	575 nm	22 mm diameter	Adaptation of the Iron Reduction Method	#064	<b>HI96773-01</b> Reagents for 50 tests <b>HI96773-03</b> Reagents for 150 tests
Oxygen Scavengers (Hydroquinone)	0.00 to 2.50 mg/L (as Hydroquinone)	0.01 mg/L	±0.04 mg/L ±3% of reading at 25 °C	575 nm	22 mm diameter	Adaptation of Iron Reduction Method	#065	<b>HI96773-01</b> Reagents for 50 tests <b>HI96773-03</b> Reagents for 150 tests
Oxygen Scavengers (Isoascorbic Acid)	0.00 to 4.50 mg/L (as Iso-Ascorbic Acid)	0.01 mg/L	±0.03 mg/L ±3% of reading at 25 °C	575 nm	22 mm diameter	Adaptation of the Iron Reduction Method	#066	<b>HI96773-01</b> Reagents for 50 tests <b>HI96773-03</b> Reagents for 150 tests
Ozone	0.00 to 2.00 mg/L (as O <sub>3</sub> )	0.01 mg/L	±0.02 mg/L ±3% of reading at 25 °C	525 nm	22 mm diameter	Colorimetric DPD Method	#067	<b>HI93757-01</b> Reagents for 100 tests <b>HI93757-03</b> Reagents for 300 tests <b>HI93703-52</b> Reagents for 100 tests (Optional)
pH	6.5 to 8.5 pH	0.1 pH	±0.1 pH at 25 °C	525 nm	22 mm diameter	Adaptation of the Phenol Red Method	#068	<b>HI93710-01</b> Reagents for 100 pH tests <b>HI93710-03</b> Reagents for 300 pH tests
Phosphorus, Marine Ultra Low Range	0 to 200 µg/L (as P)	1 µg/L	±5 µg/L ±5% of reading at 25 °C	610 nm	22 mm diameter	Adaptation of Standard Methods for the Examination of Water and Wastewater, 20th Edition, Ascorbic Acid Method	#069	<b>HI736-25</b> Reagents for 25 tests
Phosphate Low Range	0.00 to 2.50 mg/L (as PO <sub>4</sub> <sup>3-</sup> )	0.01 mg/L	±0.04 mg/L ±4% of reading at 25 °C	610 nm	22 mm diameter	Adaptation of the Ascorbic Acid Method	#070	<b>HI93713-01</b> Reagents for 100 tests <b>HI93713-03</b> Reagents for 300 tests
Phosphate High Range	0.0 to 30.0 mg/L (as PO <sub>4</sub> <sup>3-</sup> )	0.1 mg/L	±1.0 mg/L ±4% of reading at 25 °C	525 nm	22 mm diameter	Adaptation of the Standard Methods for the Examination of Water and Wastewater, 18th Edition, Amino Acid Method	#071	<b>HI93717-01</b> Reagents for 100 tests <b>HI93717-03</b> Reagents for 300 tests
Phosphorus, Acid Hydrolyzable (13 mm Vial)	0.00 to 1.60 mg/L (as P)	0.01 mg/L	±0.05 mg/L or ±5% of reading at 25 °C, whichever is greater	610 nm	13 mm diameter	Adaptation of the EPA method 365.2 and Standard Methods for the Examination of Water and Wastewater, 20th Edition, 4500-P E, Ascorbic Acid Method	#072	<b>HI93758B-50</b> Reagents for 50 tests



Parameter	Range	Resolution	Accuracy	Wavelength	Cuvette Type	Method	Method ID	Reagent Code
Phosphorus, Reactive Low Range (13 mm Vial)	0.00 to 1.60 mg/L (as P)	0.01 mg/L	±0.05 mg/L or ±4% of reading at 25 °C, whichever is greater	610 nm	13 mm diameter	Adaptation of the EPA method 365.2 and Standard Methods for the Examination of Water and Wastewater, 20th Edition, 4500-P E, Ascorbic Acid Method	#073	<b>HI93758A-50</b> Reagents for 50 tests
Phosphorus, Reactive High Range (13 mm Vial)	0.0 to 32.6 mg/L (as P)	0.1 mg/L	±0.5 mg/L or ±4% of reading at 25 °C, whichever is greater	420 nm	13 mm diameter	Adaptation of the Standard Methods for the Examination of Water and Wastewater, 20th Edition, 4500-P C, Vanadomolybdophosphoric Acid Method	#074	<b>HI93763A-50</b> Reagents for up to 49 tests
Phosphorus, Total Low Range (13 mm Vial)	0.00 to 1.60 mg/L (as P)	0.01 mg/L	±0.05 mg/L or ±5% of reading at 25 °C, whichever is greater	610 nm	13 mm diameter	Adaptation of the EPA method 365.2 and Standard Methods for the Examination of Water and Wastewater, 20th Edition, 4500-P E, Ascorbic Acid Method	#075	<b>HI93758C-50</b> Reagents for 50 tests
Phosphorus, Total High Range (13 mm Vial)	0.0 to 32.6 mg/L (as P)	0.1 mg/L	±0.5 mg/L or ±5% of reading at 25 °C, whichever is greater	420 nm	13 mm diameter	Adaptation of the Standard Methods for the Examination of Water and Wastewater, 20th Edition, 4500-P C, Vanadomolybdophosphoric Acid Method	#076	<b>HI93763B-50</b> Reagents for up to 49 tests
Potassium Low Range	0.0 to 20.0 mg/L (as K)	0.1 mg/L	±2 mg/L ±7% of reading at 25 °C	466 nm	22 mm diameter	Adaptation of the Turbidimetric Tetraphenylborate Method	#077	<b>HI93750-01</b> Reagents for 100 tests <b>HI93750-03</b> Reagents for 300 tests
Potassium Medium Range	10 to 100 mg/L (as K)	1 mg/L	±10 mg/L ±7% of reading at 25 °C	466 nm	22 mm diameter	Adaptation of the Turbidimetric Tetraphenylborate Method	#078	<b>HI93750-01</b> Reagents for 100 tests <b>HI93750-03</b> Reagents for 300 tests
Potassium High Range	20 to 200 mg/L (as K)	1 mg/L	±20 mg/L ±7% of reading at 25 °C	466 nm	22 mm diameter	Adaptation of the Turbidimetric Tetraphenylborate Method	#079	<b>HI93750-01</b> Reagents for 100 tests <b>HI93750-03</b> Reagents for 300 tests
Silica Low Range	0.00 to 2.00 mg/L (as SiO <sub>2</sub> )	0.01 mg/L	±0.03 mg/L ±5% of reading at 25 °C	610 nm	22 mm diameter	Adaptation of the ASTM Manual of Water and Environmental Technology, D859, Heteropoly Molybdenum Blue Method	#080	<b>HI93705-01</b> Reagents for 100 tests <b>HI93705-03</b> Reagents for 300 tests
Silica High Range	0 to 200 mg/L (as SiO <sub>2</sub> )	1 mg/L	±1 mg/L ±5% of reading at 25 °C	466 nm	22 mm diameter	Adaptation of the EPA Method 370.1 for Drinking, Surface and Saline Waters, Domestic and Industrial Wastes and Standard Method 4500-SiO <sub>2</sub>	#081	<b>HI96770-01</b> Reagents for 100 tests <b>HI96770-03</b> Reagents for 300 tests
Silver	0.000 to 1.000 mg/L (as Ag)	0.001 mg/L	±0.020 mg/L ±5% of reading at 25 °C	570 nm	22 mm diameter	Adaptation of the PAN Method	#082	<b>HI93737-01</b> Reagents for 50 tests <b>HI93737-03</b> Reagents for 150 tests
Sulfate	0 to 150 mg/L (as SO <sub>4</sub> <sup>2-</sup> )	1 mg/L	±5 mg/L ±3% of reading at 25 °C	466 nm	22 mm diameter	Sulfate is precipitated with barium chloride crystals	#083	<b>HI93751-01</b> Reagents for 100 tests <b>HI93751-03</b> Reagents for 300 tests
Surfactants, Anionic	0.00 to 3.50 mg/L (as SDBS)	0.01 mg/L	±0.04 mg/L ±3% of reading at 25 °C	610 nm	22 mm diameter	Adaptation of the EPA Method 425.1 and Standard Methods for the Examination of Water and Wastewater, 20th Edition, 5540C, Anionic Surfactants as MBAS	#084	<b>HI95769-01</b> Reagents for 40 tests
Surfactants, Anionic (13 mm Vial)	0.00 to 3.50 mg/L (as SDBS)	0.01 mg/L	±0.10 mg/L ±5% of reading at 25 °C	610 nm	13 mm diameter	Adaptation of the Standard Method for the Examination of Water and Wastewater, 23rd Edition, 5540C, Anionic Surfactants as MBAS	#093	<b>HI96782-25</b> Reagents for 25 tests
Surfactants, Cationic (13 mm Vial)	0.00 to 2.50 mg/L (as CTAB)	0.01 mg/L	±0.15 ppm ±3% of reading at 25 °C	420 nm	13 mm diameter	Bromophenol Blue Method	#095	<b>HI96785-25</b> Reagents for 25 tests
Surfactants, Nonionic (13 mm Vial)	0.00 to 6.00 mg/L (TRITON X-100)	0.01 mg/L	±0.10 mg/L ±5% of reading at 25 °C	610 nm	13 mm diameter	TBPE Method	#094	<b>HI96780-25</b> Reagents for 24 tests
Zinc	0.00 to 3.00 mg/L (as Zn)	0.01 mg/L	±0.03 mg/L ±3% of reading at 25 °C	620 nm	22 mm diameter	Adaptation of the Standard Methods for the Examination of Water and Wastewater, 18th Edition, Zincon Method	#085	<b>HI93731-01</b> Reagents for 100 tests <b>HI93731-03</b> Reagents for 300 tests



## Cuvette Adapters



## General Specifications

## HI801 iris®

Wavelength Range	340 to 900 nm
Wavelength Resolution	1 nm
Wavelength Accuracy	±1.5 nm
Photometric Range	0.000 to 3.000 Abs
Photometric Accuracy	5 mAbs at 0.000 to 0.500 Abs, 1 % at 0.500 to 3.000 Abs
Measurement Mode	transmittance (%), absorbance and concentration
Sample Cell	10 mm square, 50 mm rectangular, 16 mm round, 22 mm round, 13 mm round (vial)
Wavelength Selection	automatic, based on the selected method (editable for user methods only)
Light Source	tungsten halogen lamp
Optical System	split beam
Wavelength Calibration	internal, automatic at power-on with visual feedback
Stray Light	<0.1 % T at 340 nm with NaNO <sub>2</sub>
Spectral Bandwidth	5 nm
Number of Methods	up to 150 factory (96 pre-loaded), up to 100 user
Data Points Stored	9999 measured values
Export Capability	csv file format, pdf file format
Connectivity	1x USB A (mass storage host), 1x USB B (mass storage device)
Battery Life	3000 measurements or 8 hours
Power Supply	15 Vdc power adapter, 10.8 Vdc Li-Ion rechargeable battery
Environment	0 to 50 °C (32 to 122 °F), 0 to 95% RH
Dimensions	155 x 205 x 322 mm (6.1 x 8.0 x 12.6")
Weight	3 kg (6.6 lbs.)
<b>Ordering Information</b>	<b>HI801-01</b> (115V) and <b>HI801-02</b> (230V) is supplied with sample cuvette and cap, 22 mm (4 pcs.), cuvette adapters (3 pcs.), cloth for wiping cuvettes, scissors, USB cable, 15 VDC power adapter, USB flash drive, instrument quality certificate and instruction manual.
<b>Accessories</b>	<b>HI7408011</b> replacement 16mm vial adapter
	<b>HI7408012</b> replacement 10mm vial adapter
	<b>HI7408013</b> replacement 13mm vial adapter
	<b>HI7408014</b> replacement Tungsten-Halogen lamp
	<b>HI7408015</b> replacement battery

## HI801-11

## Holmium Filter

Validate HI801 iris® Wavelength Accuracy

The HI801-11 is a holmium oxide glass filter that is used to validate the wavelength accuracy of the HI801 iris spectrophotometer. The filter is mounted in a 10 mm square anodized holder and comes with a protective plastic holder that protects the filter when not in use.

- Glass filter mounted in anodized aluminum holder
- Fits all spectrophotometers that can accommodate 10 mm square cuvette
- Absorbance peaks measured at 361, 454, 536, and 638 nm.
- Holmium Oxide Filter
  - Supplied with certificate of analysis traceable to SRM2034
  - All values are certified and have an uncertainty of less than 0.1 nm
  - Packaged in light tight plastic cuvette holder

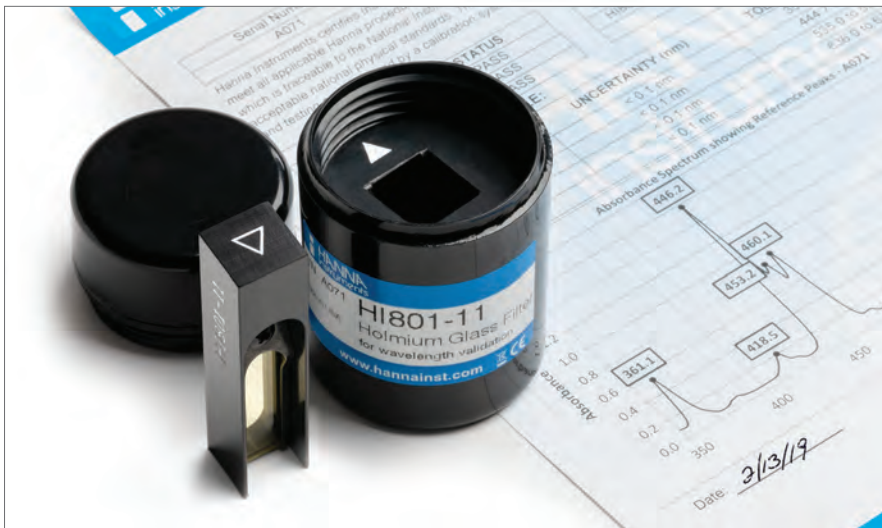

## Holmium

Holmium is a rare earth element that is silvery white and malleable. Holmium reacts with oxygen to form holmium oxide. Glasses that contain holmium oxide or holmium oxide solution are useful in the calibration of spectrophotometers due to their sharp absorption peaks in the visible spectrum. The National Institute of Technology (N.I.S.T.), formerly National Bureau of Standards (N.B.S.) uses a holmium oxide solution sealed into silica cuvettes as the standard reference material (SRM 2034) for traceability. The holmium oxide solution is prepared with holmium oxide dissolved in perchloric acid. This solution has many well-defined absorption bands. The SRM2034 was found to be stable for up to thirty years\*

The HI801-11 is traceable to SRM2034 and is supplied with certificate of that identifies the peak absorbance values of the filter within 0.1 nm of uncertainty. The HI801-11 holmium oxide filter is used with the wavelength check mode found in the HI801 iris spectrophotometer. The filter is placed into the meter and the wavelength check mode is then used to verify the wavelength positioning. Once the check is complete the meter will display the wavelength peaks and they are compared to the values found on the certificate. The values should be within  $\pm 1.5$  nm of the certified value.

\* NIST Special Publication 260-192

## Specifications

## HI801-11

Description	The HI801-11 is a holmium glass filter that is mounted in a 10 mm square anodized aluminum cuvette.
Peak Wavelengths @ 25°C	361, 446, 536, 637. Actual value traceable to SRM2034 found on COA
Peak Wavelength Uncertainty @ 25°C	<0.1 nm for all peaks
Dimensions	10 x 10 mm
Recommended use	Wavelength check of HI801 iris
<b>Ordering Information</b>	<b>HI801-11</b> is supplied with quality certificate with values that have an uncertainty of less than 0.1 nm.

# Multiparameter Photometers

with Digital pH Electrode Input



Since 1978, Hanna has introduced instruments that tailor to the needs of a specific application or industry. From this philosophy we have created Application Designed Photometers to satisfy the needs of your specific application or industry.

Aquaculture	HI83303
Boilers & Cooling Towers	HI83305
Environmental Analysis	HI83306
Laboratory Analyses	HI83300
Nutrient Analyses	HI83225
Pool and Spa Applications	HI83326
Water Conditioning	HI83308

- **Advanced optical system**
  - Innovative optical design that utilizes a reference detector and focusing lens to eliminate errors from changes in the light source and from imperfections in the glass cuvette.
- **Up to 73 different programmed methods measuring 40 key water and wastewater quality parameters.**
- **Absorbance mode**
  - Absorbance measurement mode for performance verification and can also be used to plot a custom concentration versus absorbance curve useful for user-supplied chemistry and for teaching students about photometry.
- **High performance pH meter** that uses advanced digital pH/temperature electrodes.



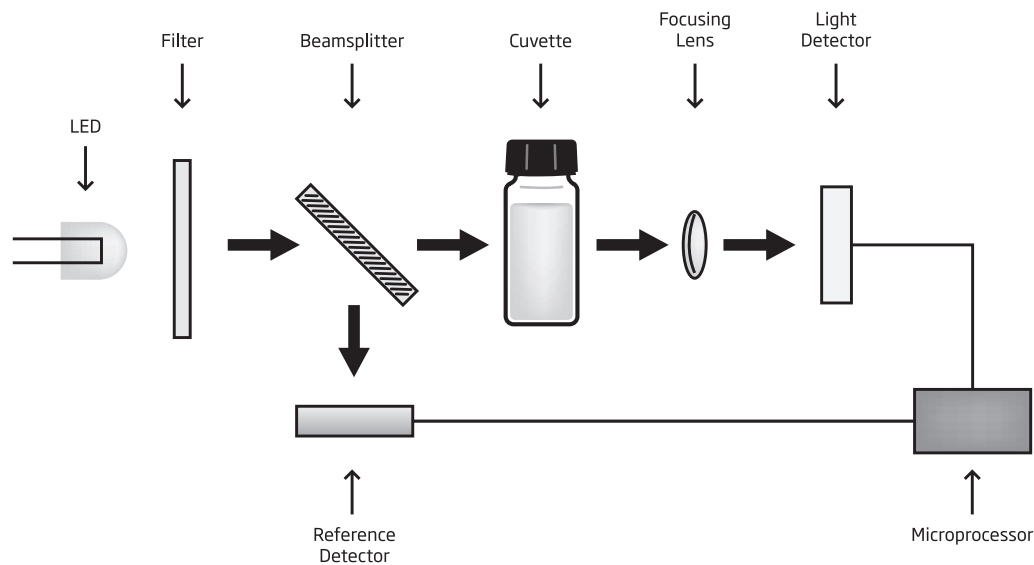

## Improved Optical System

HI83300 family is designed with an innovative optical system that incorporates a beam splitter so that light can be used for absorbance readings and by the reference detector. The reference detector monitors the intensity of light and modulates when there is drift due to power fluctuation or the heating of the optical components. Each part has an important role in providing unparalleled performance from a photometer.

## High Efficiency LED Light Source

An LED light source offers superior performance as compared to a tungsten lamp. LEDs have a much higher luminous efficiency, providing more light while using less power. They also produce very little heat, which could otherwise affect the optical components and electronic stability.

## Quality Narrow Band Interference Filters

The narrow band interference filter not only ensures greater wavelength accuracy ( $\pm 1$  nm) but is also extremely efficient, allowing a brighter, stronger signal to be transmitted. The end result is increased measurement stability and less wavelength error.

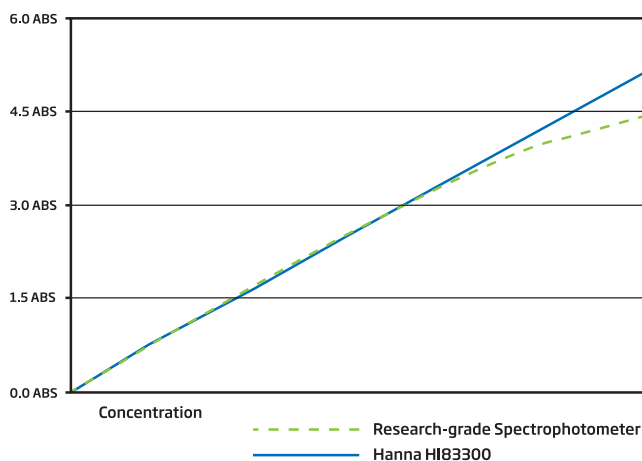

*Better linearity than research-grade spectrophotometers*

## Reference Detector for a Stable Light Source

A beam splitter is used as part of the internal reference system of the HI83300 photometer. The reference detector compensates for any drift due to power fluctuations or ambient temperature changes. Now you can rely on a stable source of light.

## Large Cuvette Size

The sample cell of the HI83300 fits a round, glass cuvette with a 25 mm path length. Along with the advanced optical components, the larger size of the cuvette greatly reduces errors in rotation from the indexing mark of the cuvettes. The relatively long path length of the sample cuvette allows the light to pass through more of the sample solution, ensuring accurate measurements even in low absorbance samples.

## Focusing Lens for Greater Light Yield

Adding a focusing lens to the optical path allows for the collection of all of the light that exits the cuvette and focusing the light on the silicon photo detector. This innovative approach to photometric measurements cancels the errors from imperfections and scratches present in the glass cuvette eliminating the need to index the cuvette.

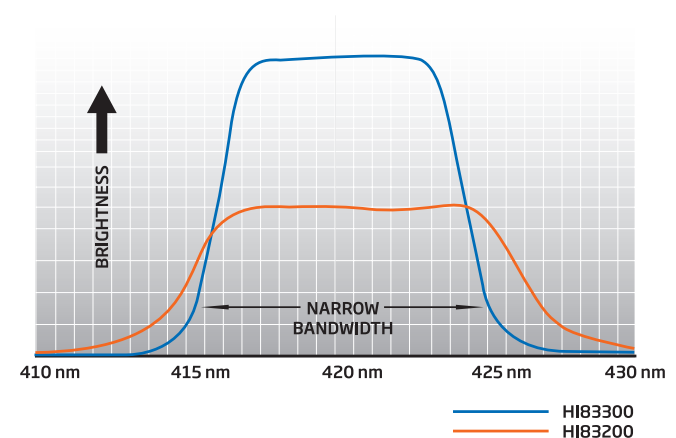

*Improved optical filters – higher wavelength accuracy and light throughput*



## Connectivity



### ① pH Connectivity

Any of our digital pH electrodes can be connected to the HI83300 family by a 3.5 mm input. Plugging in an electrode has never been easier; there are no alignment issues or broken pins. Simply connect the electrode and start taking measurements.

### ② Dual Power Supply

What makes the HI83300 family such versatile meters is their ability to be used as a portable or benchtop meter. Equipped with a rechargeable lithium ion battery, these meters can easily be brought on the production room floor or taken for measurements on the move. This long-

lasting battery lasts up to 500 photometer measurements or 50 hours of continuous pH measurements. To further preserve battery life, the auto-off feature automatically shuts off the meter after 15 minutes of inactivity. If being used on a benchtop, a power supply can be plugged into the micro USB port at the back of the meter.

### ② ③ USB Connectivity

Both a USB and micro USB port are located on the meters. Each of these ports can be used to transfer data via flash drive or direct connection to a PC or MAC. Data is transferred as CSV files for easy processing and widespread compatibility.

## Photometer Capabilities

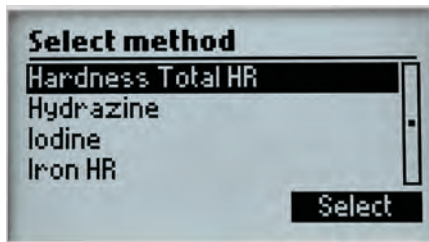

### Concentration Measurement Function

Users can access the menu of measurement methods with the simple press of a button. Low, medium, and high range methods of several parameters are available for users to obtain a high accuracy reading. Each method is assigned a concentration unit of measure. Parameters can be expressed in different chemical forms based on their preference.

### CAL Check™ Functionality

Hanna's exclusive CAL Check feature allows for performance verification of the independent measuring channels. Our CAL Check standard vials are developed to simulate a specific absorbance value at each wavelength to verify its accuracy.

### Built-in Reaction Timer

Reaction time is of key importance when performing colorimetric measurements, which is why the built-in timer of the HI83300 is a key feature. The countdown timer displays the time remaining until a measurement will be taken, ensuring consistent results between measurements and users.

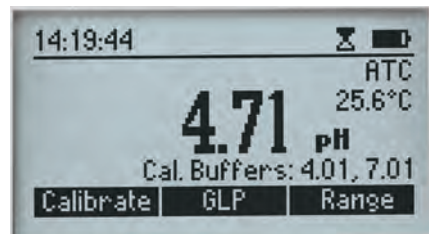

### pH Measurement

The HI83300 family offers the ability to connect a digital pH electrode. Users can connect any sensor from our extensive line of digital pH electrodes. Whether a user requires a glass or plastic body, a spheric or conical tip shape, or the ability for safe use with food samples, our digital electrode offering is suitable for nearly everyone.



### Large Cuvettes

The sample cell of these meters fits a round, glass cuvette with a 25 mm path length. The relatively long path length of the sample cuvette allows the light to pass through more of the sample solution, ensuring accurate measurements even in low absorbance samples. This cuvette size also provides a larger opening, making it easier for users to dispense ready-made liquid or powder reagents into the sample.

An affixed, light-blocking cover panel closes over the sample cell, reducing stray light from affecting any measurement readings.



### Absorbance Measurement Mode

Users can select to calibrate and measure samples in absorbance mode for each wavelength used by the meter. This mode is a convenient way for users to develop their own calibration curves and measure samples with customized chemistries.

## Data Management Capabilities

### User ID and Sample ID

An alphanumeric keypad can be used to enter sample ID and user ID to be stored with the measurement reading. The recall key allows the user to review the data along with the date and time that the reading was taken.

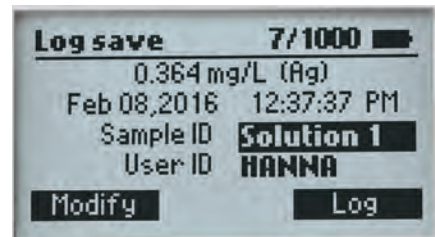

### Data Management

The HI83300 family can store up to 1000 photometer and pH electrode readings, which can be logged by pressing the LOG key on the face of the meter. pH readings are logged along with comprehensive GLP (Good Laboratory Practice) information such as date, time, calibration buffers, and electrode offset and slope.

### USB for Data Transfer

Two USB ports are provided for transferring data. One port allows the data to be transferred to a flash drive while the other USB is used for direct connection to a computer. All data is transferred as a .CSV file that can be used with many spreadsheet programs for documentation.

## Display Features



### Backlit Graphic LCD Display

A backlit, graphic LCD display provides an easy to read, user-friendly interface.

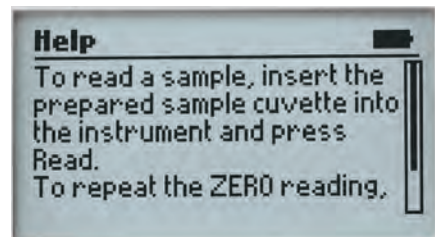

### Intuitive Display

With virtual keys, a battery status indicator, and practical error messages, users will find the meter interface intuitive. On-screen guides provide information relating to the current meter operation, and can be used at any stage in the setup or measurement process to show contextual help.



### General Specifications for all Models

Measurement Channels	5 x optical channels; 1 x digital electrode channel (pH measurement)		
Photometer	Range	0.000 to 4.000 Abs	
	Resolution	0.001 Abs	
	Accuracy	±0.003 Abs @ 1.000 Abs	
	Light Source	Light Emitting Diode	
	Bandpass Filter Bandwidth	8 nm	
	Bandpass Filter Wavelength Accuracy	± 1.0 nm	
	Light Detector	Silicon photocell	
	Cuvette Type	round, 24.6 mm diameter and 16 mm diameter	
Number of Methods	Dependant on model		
Probe	Range	-2.00 to 16.00 pH (±1000 mV)*	
	Resolution	0.01 pH (0.1 mV)	
	Accuracy	±0.01 pH (±0.2 mV) @ 25 °C / 77 °F	
	Temperature Compensation	ATC, -5.0 to 100.0 °C (23.0 to 212.0 °F)*	
	Calibration	two-point, from five available buffers (4.01, 6.86, 7.01, 9.18, 10.01 pH)	
Electrode (sold separately)	Intelligent pH / temperature electrode		
Temperature	Range	-20.0 to 120.0 °C (-4.0 to 248.0 °F)	
	Resolution	0.1 °C (0.1 °F)	
	Accuracy	0.5 °C @ 25 °C (±0.9 °F @ 77 °F)	
Additional Specifications	Logging	1000 readings (mixed photometer and electrode)	
	Display	128 x 64 pixel B/W LCD with backlight	
	USB-A (Host) functions	Mass-storage host	
	USB-B (Device) functions	Power input, mass-storage device	
	Battery Life	> 500 photometer measurements or 50 hours of continuous pH measurement	
	Power Supply	5 Vdc USB 2.0 power adapter / type micro-B connector 3.7 Vdc Li-polymer rechargeable battery, non-serviceable	
	Environment	0 to 50 °C (32 to 122 °F) 0 to 95% RH, non-serviceable	
	Dimensions	206 x 177 x 97 mm (8.1 x 7.0 x 3.8 in.)	
Weight	1.0 kg (2.2 lbs.)		

\*Limits will be reduced to actual probe / sensor limits





**HI83300-100** sample preparation kit consisting of activated carbon for 50 tests, demineralizer for preparation of 10 L deionized water (100 g), 170 mL graduated beaker, 100 mL beaker, 3 mL pipette, 60 mL syringe, 5 mL syringe, graduated cylinder, spoon, funnel, paper filters (25)



**HI72083300** carrying case for HI83300 family



**HI920015** USB to micro USB cable connector



**HI740224** plastic beaker 170 mL (12)



**HI740225** 60 mL graduated syringe



**HI740226** 5 mL graduated syringe



**HI76404A** electrode holder for HI83300 family



**HI731318** cuvette cleaning cloth (4)



**HI731331** cuvette (4)  
**HI731335N** caps for cuvette (4)



**HI93703-55** activated carbon for 50 tests



**HI11310** digital combination pH electrode



**HI75110/220U** Voltage adapter from 115 VAC to USB 5 VDC (USA plug)  
**HI75110/220E** Voltage adapter from 230 VAC to USB 5 VDC (European plug)



**HI740036P** beaker, plastic 100 mL (10)  
**HI740034P** cap for 100 mL plastic beaker (10)

HI83300

# Multiparameter Photometer

with Digital pH Electrode Input  
for Laboratories

HI83300 is a compact, multiparameter photometer for use in the lab or in the field. The meter is one of the most advanced photometers available with an innovative optical design that utilizes a reference detector and focusing lens to eliminate errors from changes in the light source and from imperfections in the glass cuvette. This meter has 63 different programmed methods measuring 37 key water quality parameters and also offers an absorbance measurement mode for performance verification and for users that would like to develop their own concentration versus absorbance curves.

To save valuable laboratory benchtop space, the HI83300 doubles as a professional pH meter with its digital pH/temperature electrode input. Now one meter can be used for both photometric and pH measurements.



- **Advanced optical system**
  - Innovative optical design that utilizes a reference detector and focusing lens to eliminate errors from changes in the light source and from imperfections in the glass cuvette
- **Backlit 128 x 64 Pixel Graphic LCD Display**
  - Backlit graphic display allows for easy viewing in low light conditions
  - The 128 x 64 Pixel LCD allows for a simplified user interface with virtual keys and on-screen help to guide the user through use of the meter
- **Built-in Reaction Timer for Photometric Measurements**
  - The measurement is taken after the countdown timer expires.
  - Countdown timer ensures that all readings are taken at the appropriate reaction intervals regardless of user for better consistency in measurements
- **Absorbance mode**
  - Hanna's exclusive CAL Check™ cuvettes for validation of light source and detector
  - Allows for the user to plot concentration versus absorbance for a specific wavelength for use with user supplied chemistry or for teaching principles of photometry
- **Units of Measure**
  - Appropriate unit of measure along with chemical form is displayed along with reading
- **Result Conversion**
  - Automatically convert readings to other chemical forms with the touch of a button
- **Cuvette Cover**
  - Aids in preventing stray light from affecting measurements
- **Digital pH Electrode Input**
  - Measure pH and temperature with a single probe
  - Good Laboratory Practice (GLP) to track calibration information including date, time, buffers used, offset and slope for traceability
  - pH CAL Check alerts user to potential problems during the calibration process
  - Space saving having a pH meter and photometer built into one meter
- **Data Logging**
  - Up to 1000 photometric and pH readings can be stored by simply pressing the dedicated LOG button. Logged readings are just as easily recalled by pressing the RCL button
- Sample ID and User ID information can be added to a logged reading using the alphanumeric keypad
- **Connectivity**
  - Logged readings can be quickly and easily transferred to a flash drive using the USB-A host port or to a computer using the micro USB-B port
  - Data is exported as a .CSV file for use with common spreadsheet programs
- **Rechargeable Battery**
  - Li-polymer rechargeable battery lasts for 500 measurements or 50 hours of pH measurement
- **Battery Status Indicator**
  - Indicates the amount of battery life left
- **Error Messages**
  - Photometric error messages
  - pH calibration messages include clean electrode, check buffer and check probe



HI83300-11

Parameter	Range	Resolution	Accuracy	Wavelength	Method	Reagent Code
Alkalinity	0 to 500 mg/L (as CaCO <sub>3</sub> )	1 mg/L	±5 mg/L ±5% of reading at 25 °C	610 nm	Bromocresol Green	<b>HI775-26</b> Reagents for 25 tests
Alkalinity, Marine	0 to 300 mg/L (as CaCO <sub>3</sub> )	1 mg/L	±5 mg/L ±5% of reading at 25 °C	610 nm	Bromocresol Green	<b>HI755-26</b> Reagents for 25 tests
Aluminum	0.00 to 1.00 mg/L (as Al <sup>3+</sup> )	0.01 mg/L	±0.04 mg/L ±4% of reading at 25 °C	525 nm	Adaptation of the Aluminon Method	<b>HI93712-01</b> Reagents for 100 tests <b>HI93712-03</b> Reagents for 300 tests
Ammonia Low Range	0.00 to 3.00 mg/L (as NH <sub>3</sub> -N)	0.01 mg/L	±0.04 mg/L ±4% of reading at 25 °C	420 nm	Adaptation of the ASTM Manual of Water and Environmental Technology, D1426 Nessler Method	<b>HI93700-01</b> Reagents for 100 tests <b>HI93700-03</b> Reagents for 300 tests
Ammonia Medium Range	0.00 to 10.00 mg/L (as NH <sub>3</sub> -N)	0.01 mg/L	±0.05 mg/L ±5% of reading at 25 °C	420 nm	Adaptation of the ASTM Manual of Water and Environmental Technology, D1426, Nessler Method	<b>HI93715-01</b> Reagents for 100 tests <b>HI93715-03</b> Reagents for 300 tests
Ammonia High Range	0.0 to 100.0 mg/L (as NH <sub>3</sub> -N)	0.1 mg/L	±0.5 mg/L ±5% of reading at 25 °C	420 nm	Adaptation of the ASTM Manual of Water and Environmental Technology, D1426, Nessler Method	<b>HI93733-01</b> Reagents for 100 tests <b>HI93733-03</b> Reagents for 300 tests
Bromine	0.00 to 8.00 mg/L (as Br <sub>2</sub> )	0.01 mg/L	±0.08 mg/L ±3% of reading at 25 °C	525 nm	Adaptation of the Standard Methods for the Examination of Water and Wastewater, 18th Edition, DPD Method	<b>HI93716-01</b> Reagents for 100 tests <b>HI93716-03</b> Reagents for 300 tests
Calcium	0 to 400 mg/L (as Ca <sup>2+</sup> )	1 mg/L	±10 mg/L ±5% of reading at 25 °C	466 nm	Adaptation of the Oxalate Method	<b>HI937521-01</b> Reagents for 50 tests <b>HI937521-03</b> Reagents for 150 tests
Calcium, Marine	200 to 600 mg/L (as Ca <sup>2+</sup> )	1 mg/L	±6% of reading at 25 °C	610 nm	Adaptation of the Zincon Method	<b>HI758-26</b> Reagents for 25 tests
Chloride	0.0 to 20.0 mg/L (as Cl <sup>-</sup> )	0.1 mg/L	±0.5 mg/L ±6% of reading at 25 °C	466 nm	Adaptation of the Mercury (II) Thiocyanate Method	<b>HI93753-01</b> Reagents for 100 tests <b>HI93753-03</b> Reagents for 300 tests
Chlorine Dioxide	0.00 to 2.00 mg/L (as ClO <sub>2</sub> )	0.01 mg/L	±0.10 mg/L ±5% of reading at 25 °C	575 nm	Adaptation of the Chlorophenol Red Method	<b>HI93738-01</b> Reagents for 100 tests <b>HI93738-03</b> Reagents for 300 tests
Chlorine Dioxide (Rapid)	0.00 to 2.00 mg/L (as ClO <sub>2</sub> )	0.01 mg/L	±0.10 mg/L ±5% of reading at 25 °C	525 nm	Adaptation of Standard Methods for the Examination of Water and Wastewater, 18th Edition, 4500 ClO <sub>2</sub> D	<b>HI96779-01</b> Reagents for 100 tests <b>HI96779-03</b> Reagents for 300 tests
Chlorine, Free Ultra Low Range	0.000 to 0.500 mg/L (as Cl <sub>2</sub> )	0.001 mg/L	±0.020 mg/L ±3% of reading at 25 °C	525 nm	Adaptation of the Standard Method 4500-Cl G	<b>HI95762-01</b> Reagents for 100 tests <b>HI95762-03</b> Reagents for 300 tests
Chlorine, Free	0.00 to 5.00 mg/L (as Cl <sub>2</sub> )	0.01 mg/L	±0.03 mg/L ±3% of reading at 25 °C	525 nm	Adaptation of the EPA DPD Method 330.5	<b>HI93701-F</b> Reagents for 300 tests (liquid) <b>HI93701-01</b> Reagents for 100 tests (powder) <b>HI93701-03</b> Reagents for 300 tests (powder)
Chlorine, Total Ultra Low Range	0.000 to 0.500 mg/L (as Cl <sub>2</sub> )	0.001 mg/L	±0.020 mg/L ±3% of reading at 25 °C	525 nm	Adaptation of the EPA DPD Method 330.5	<b>HI95761-01</b> Reagents for 100 tests <b>HI95761-03</b> Reagents for 300 tests
Chlorine, Total	0.00 to 5.00 mg/L (as Cl <sub>2</sub> )	0.01 mg/L	±0.03 mg/L ±3% of reading at 25 °C	525 nm	Adaptation of the EPA DPD Method 330.5	<b>HI93701-T</b> Reagents for 300 tests (liquid) <b>HI93711-01</b> Reagents for 100 total tests (powder) <b>HI93711-03</b> Reagents for 300 total tests (powder)
Chlorine, Total Ultra High Range	0 to 500 mg/L (as Cl <sub>2</sub> )	1 mg/L	±3 mg/L ±3% of reading at 25 °C	525 nm	Adaptation of the Standard Methods for Examination of Water and Wastewater, 20th Edition, 4500-Cl	<b>HI95771-01</b> Reagents for 100 tests <b>HI95771-03</b> Reagents for 300 tests
Chromium (VI) Low Range	0 to 300 µg/L (as Cr(VI))	1 µg/L	±10 µg/L ±4% of reading at 25 °C	525 nm	Adaptation of the ASTM Manual of Water and Environmental Technology, D1687 Diphenylcarbohydrazide Method	<b>HI93749-01</b> Reagents for 100 tests <b>HI93749-03</b> Reagents for 300 tests
Chromium (VI) High Range	0 to 1000 µg/L (as Cr(VI))	1 µg/L	±5 µg/L ±4% of reading at 25 °C	525 nm	Adaptation of the ASTM Manual of Water and Environmental Technology, D1687-92, Diphenylcarbohydrazide Method	<b>HI93723-01</b> Reagents for 100 tests <b>HI93723-03</b> Reagents for 300 tests
Color of Water	0 to 500 PCU (Platinum Cobalt Units)	1 PCU	±10 PCU ±5% of reading at 25 °C	420 nm	Adaptation of the Standard Methods for the Examination of Water and Wastewater, 18th Edition, Colorimetric Platinum Cobalt Method	–
Copper Low Range	0.000 to 1.500mg/L (as Cu <sup>2+</sup> )	0.001mg/L	±0.010mg/L ±5% of reading at 25 °C	575 nm	Adaptation of the EPA Method	<b>HI95747-01</b> Reagents for 100 tests <b>HI95747-03</b> Reagents for 300 tests
Copper High Range	0.00 to 5.00 mg/L (as Cu <sup>2+</sup> )	0.01 mg/L	±0.02 mg/L ±4% of reading at 25 °C	575 nm	Adaptation of the EPA Method	<b>HI93702-01</b> Reagents for 100 tests <b>HI93702-03</b> Reagents for 300 tests
Cyanuric Acid	0 to 80 mg/L (as CYA)	1 mg/L	±1 mg/L ±15% of reading at 25 °C	525 nm	Adaptation of the Turbidimetric Method	<b>HI93722-01</b> Reagents for 100 tests <b>HI93722-03</b> Reagents for 300 tests

Parameter	Range	Resolution	Accuracy	Wavelength	Method	Reagent Code
Fluoride Low Range	0.00 to 2.00 mg/L (as F <sup>-</sup> )	0.01 mg/L	±0.03 mg/L ±3% of reading at 25 °C	575 nm	Adaptation of the Standard Methods for the Examination of Water and Wastewater, 18th Edition, SPADNS Method	<b>HI93729-01</b> Reagents for 100 tests
						<b>HI93729-03</b> Reagents for 300 tests
Fluoride High Range	0.0 to 20.0 mg/L (as F <sup>-</sup> )	0.1 mg/L	±0.5 mg/L ±3% of reading at 25 °C	575 nm	Adaptation of the Standard Methods for the Examination of Water and Wastewater, 18th Edition, SPADNS Method	<b>HI93739-01</b> Reagents for 100 tests
						<b>HI93739-03</b> Reagents for 300 tests
Hardness, Calcium	0.00 to 2.70 mg/L (as CaCO <sub>3</sub> )	0.01 mg/L	±0.11 mg/L ±5% of reading at 25 °C	525 nm	Adaptation of the Standard Methods for the Examination of Water and Wastewater, 18th Edition, Calmagite Method	<b>HI93720-01</b> Reagents for 100 tests
						<b>HI93720-03</b> Reagents for 300 tests
Hardness, Magnesium	0.00 to 2.00 mg/L (as CaCO <sub>3</sub> )	0.01 mg/L	±0.11 mg/L ±5% of reading at 25 °C	525 nm	Adaptation of the Standard Methods for the Examination of Water and Wastewater, 18th Edition, EDTA Colorimetric Method	<b>HI93719-01</b> Reagents for 100 tests
						<b>HI93719-03</b> Reagents for 300 tests
Hardness, Total Low Range	0 to 250 mg/L (as CaCO <sub>3</sub> )	1 mg/L	±5 mg/L ±4% of reading at 25 °C	466 nm	Adaptation of the EPA Method 130.1	<b>HI93735-00</b> Reagents for 100 tests (LR, 0 to 250mg/L)
						<b>HI93735-0</b> Reagents for 300 tests (LR - 100 tests, MR - 100 tests, HR - 100 tests)
Hardness, Total Medium Range	200 to 500 mg/L (as CaCO <sub>3</sub> )	1 mg/L	±7 mg/L ±3% of reading at 25 °C	466 nm	Adaptation of the EPA Method 130.1	<b>HI93735-01</b> Reagents for 100 tests (MR, 200 to 500mg/L)
						<b>HI93735-0</b> Reagents for 300 tests (LR - 100 tests, MR - 100 tests, HR - 100 tests)
Hardness, Total High Range	400 to 750 mg/L (as CaCO <sub>3</sub> )	1 mg/L	±10 mg/L ±2% of reading at 25 °C	466 nm	Adaptation of the EPA Method 130.1	<b>HI93735-02</b> Reagents for 100 tests (HR, 400 to 750mg/L)
						<b>HI93735-0</b> Reagents for 300 tests (LR - 100 tests, MR - 100 tests, HR - 100 tests)
Hydrazine	0 to 400 µg/L (as N <sub>2</sub> H <sub>4</sub> )	1 µg/L	±4% of full scale reading at 25 °C	466 nm	Adaptation of the ASTM Manual of Water and Environmental Technology, Method D1385, p-Dimethylaminobenzaldehyde Method	<b>HI93704-01</b> Reagents for 100 tests
						<b>HI93704-03</b> Reagents for 300 tests
Iodine	0.0 to 12.5 mg/L (as I <sub>2</sub> )	0.1 mg/L	±0.1 mg/L ±5% of reading at 25 °C	525 nm	Adaptation of the Standard Methods for the Examination of Water and Wastewater, 18th Edition, DPD Method	<b>HI93718-01</b> Reagents for 100 tests
						<b>HI93718-03</b> Reagents for 300 tests
Iron Low Range	0.000 to 1.600 mg/L (as Fe)	0.001 mg/L	±0.010 mg/L ±8% of reading at 25 °C	575 nm	Adaptation of the TPTZ Method	<b>HI93746-01</b> Reagents for 50 tests
						<b>HI93746-03</b> Reagents for 150 tests
Iron High Range	0.00 to 5.00 mg/L (as Fe)	0.01 mg/L	±0.04 mg/L ±2% of reading at 25 °C	525 nm	Adaptation of Standard Methods for the Examination of Water and Wastewater, 23rd Edition, 3500-Fe-B, Phenanthroline Method	<b>HI93721-01</b> Reagents for 100 tests
						<b>HI93721-03</b> Reagents for 300 tests
Iron (II)	0.00 to 6.00 mg/L (as Fe <sup>2+</sup> )	0.01 mg/L	±0.10 mg/L ±2% of reading at 25 °C	525 nm	Adaptation of Standard Methods for the Examination of Water and Wastewater, 23rd Edition, 3500-Fe-B, Phenanthroline Method	<b>HI96776-01</b> Reagents for 100 tests
						<b>HI96776-03</b> Reagents for 300 tests
Iron(II)/(III)	0.00 to 6.00mg/L (as Fe)	0.01mg/L	±0.10 mg/L ±2% of reading at 25°C	525 nm	Adaptation of Standard Methods for the Examination of Water and Wastewater, 23rd Edition, 3500-Fe-B, Phenanthroline Method	<b>HI96777-01</b> Reagents for 100tests
						<b>HI96777-03</b> Reagents for 300tests
Magnesium	0 to 150 mg/L (as Mg <sup>2+</sup> )	1 mg/L	±5 mg/L ±3% of reading at 25 °C	466 nm	Adaptation of the Calmagite Method	<b>HI937520-01</b> Reagents for 50 tests
						<b>HI937520-03</b> Reagents for 150 tests
Manganese Low Range	0 to 300 µg/L (as Mn)	1 µg/L	±10 µg/L ±3% of reading at 25 °C	575 nm	Adaptation of the PAN Method	<b>HI93748-01</b> Reagents for 50 tests
						<b>HI93748-03</b> Reagents for 150 tests
Manganese High Range	0.0 to 20.0 mg/L (as Mn)	0.1 mg/L	±0.2 mg/L ±3% of reading at 25 °C	525 nm	Adaptation of the Standard Methods for the Examination of Water and Wastewater, 18th Edition, Periodate Method	<b>HI93709-01</b> Reagents for 100 tests
						<b>HI93709-03</b> Reagents for 300 tests
Molybdenum	0.0 to 40.0 mg/L (as Mo <sup>6+</sup> )	0.1 mg/L	±0.3 mg/L ±5% of reading at 25 °C	420 nm	Adaptation of the Mercaptoacetic Acid Method	<b>HI93730-01</b> Reagents for 100 tests
						<b>HI93730-03</b> Reagents for 300 tests
Nickel Low Range	0.000 to 1.000 mg/L (as Ni)	0.001 mg/L	±0.010 mg/L ±7% of reading at 25 °C	575 nm	Adaptation of the PAN Method	<b>HI93740-01</b> Reagents for 50 tests
						<b>HI93740-03</b> Reagents for 150 tests
Nickel High Range	0.00 to 7.00 g/L (as Ni)	0.01 g/L	±0.07 g/L ±4% of reading at 25 °C	575 nm	Adaptation of the Photometric Method	<b>HI93726-01</b> Reagents for 100 tests
						<b>HI93726-03</b> Reagents for 300 tests
Nitrate	0.0 to 30.0 mg/L (as NO <sub>3</sub> <sup>-</sup> -N)	0.1 mg/L	±0.5 mg/L ±10% of reading at 25 °C	525 nm	Adaptation of the Cadmium Reduction Method	<b>HI93728-01</b> Reagents for 100 tests
						<b>HI93728-03</b> Reagents for 300 tests
Nitrite, Marine Ultra Low Range	0 to 200 µg/L (as NO <sub>2</sub> <sup>-</sup> -N)	1 µg/L	±10 µg/L ±4% of reading at 25 °C	466 nm	Adaptation of the EPA Diazotization Method 354.1	<b>HI764-25</b> Reagents for 25 tests
Nitrite Low Range	0 to 600 µg/L (as NO <sub>2</sub> <sup>-</sup> -N)	1 µg/L	±20 µg/L ±4% of reading at 25 °C	466 nm	Adaptation of the EPA Diazotization Method 354.1	<b>HI93707-01</b> Reagents for 100 tests
						<b>HI93707-03</b> Reagents for 300 tests
Nitrite High Range	0 to 150 mg/L (as NO <sub>2</sub> <sup>-</sup> )	1 mg/L	±4 mg/L ±4% of reading at 25 °C	575 nm	Adaptation of the Ferrous Sulfate Method	<b>HI93708-01</b> Reagents for 100 tests
						<b>HI93708-03</b> Reagents for 300 tests

Parameter	Range	Resolution	Accuracy	Wavelength	Method	Reagent Code
Oxygen, Dissolved	0.0 to 10.0 mg/L (as O <sub>2</sub> )	0.1 mg/L	±0.4 mg/L ±3% of reading at 25 °C	420 nm	Adaptation of the Standard Methods for the Examination of Water and Wastewater, 18th Edition, Azide Modified Winkler Method	<b>HI93732-01</b> Reagents for 100 tests <b>HI93732-03</b> Reagents for 300 tests
Oxygen Scavengers (Carbohydrazide)	0.00 to 1.50 mg/L (as Carbohydrazide)	0.01 mg/L	±0.02 mg/L ±3% of reading at 25 °C	575 nm	Adaptation of the Iron Reduction Method	<b>HI96773-01</b> Reagents for 50 tests <b>HI96773-03</b> Reagents for 150 tests
Oxygen Scavengers (Diethylhydroxylamine) (DEHA)	0 to 1000 µg/L (as DEHA)	1 µg/L	±5 µg/L ±5% of reading at 25 °C	575 nm	Adaptation of the Iron Reduction Method	<b>HI96773-01</b> Reagents for 50 tests <b>HI96773-03</b> Reagents for 150 tests
Oxygen Scavengers (Hydroquinone)	0.00 to 2.50 mg/L (as Hydroquinone)	0.01 mg/L	±0.04 mg/L ±3% of reading at 25 °C	575 nm	Adaptation of Iron Reduction Method	<b>HI96773-01</b> Reagents for 50 tests <b>HI96773-03</b> Reagents for 150 tests
Oxygen Scavengers (Iso-ascorbic Acid)	0.00 to 4.50 mg/L (as Iso-Ascorbic Acid)	0.01 mg/L	±0.03 mg/L ±3% of reading at 25 °C	575 nm	Adaptation of the Iron Reduction Method	<b>HI96773-01</b> Reagents for 50 tests <b>HI96773-03</b> Reagents for 150 tests
Ozone	0.00 to 2.00 mg/L (as O <sub>3</sub> )	0.01 mg/L	±0.02 mg/L ±3% of reading at 25 °C	525 nm	Colorimetric DPD Method	<b>HI93757-01</b> Reagents for 100 tests <b>HI93757-03</b> Reagents for 300 tests <b>HI93703-52</b> Reagents for 100 tests (Optional)
pH	6.5 to 8.5 pH	0.1 pH	±0.1 pH at 25 °C	525 nm	Adaptation of the Phenol Red Method	<b>HI93710-01</b> Reagents for 100 pH tests <b>HI93710-03</b> Reagents for 300 pH tests
Phosphate, Marine Ultra Low Range	0 to 200 µg/L (as P)	1 µg/L	±5 µg/L ±5% of reading at 25 °C	610 nm	Adaptation of Standard Methods for the Examination of Water and Wastewater, 20th Edition, Ascorbic Acid Method	<b>HI736-25</b> Reagents for 25 tests
Phosphate Low Range	0.00 to 2.50 mg/L (as PO <sub>4</sub> <sup>3-</sup> )	0.01 mg/L	±0.04 mg/L ±4% of reading at 25 °C	610 nm	Adaptation of the Ascorbic Acid Method	<b>HI93713-01</b> Reagents for 100 tests <b>HI93713-03</b> Reagents for 300 tests
Phosphate High Range	0.0 to 30.0 mg/L (as PO <sub>4</sub> <sup>3-</sup> )	0.1 mg/L	±1.0 mg/L ±4% of reading at 25 °C	525 nm	Adaptation of the Standard Methods for the Examination of Water and Wastewater, 18th Edition, Amino Acid Method	<b>HI93717-01</b> Reagents for 100 tests <b>HI93717-03</b> Reagents for 300 tests
Potassium	0.0 to 20.0 mg/L (as K)	0.1 mg/L	±3 mg/L ±7% of reading at 25 °C	466 nm	Adaptation of the Turbidimetric Tetraphenylborate Method	<b>HI93750-01</b> Reagents for 100 tests <b>HI93750-03</b> Reagents for 300 tests
Silica Low Range	0.00 to 2.00 mg/L (as SiO <sub>2</sub> )	0.01 mg/L	±0.03 mg/L ±3% of reading at 25 °C	610 nm	Adaptation of the ASTM Manual of Water and Environmental Technology, D859, Heteropoly Molybdenum Blue Method	<b>HI93705-01</b> Reagents for 100 tests <b>HI93705-03</b> Reagents for 300 tests
Silica High Range	0 to 200 mg/L (as SiO <sub>2</sub> )	1 mg/L	±1 mg/L ±5% of reading at 25 °C	466 nm	Adaptation of the EPA Method 370.1 for Drinking, Surface and Saline Waters, Domestic and Industrial Wastes and Standard Method 4500-SiO <sub>2</sub>	<b>HI96770-01</b> Reagents for 100 tests <b>HI96770-03</b> Reagents for 300 tests
Silver	0.000 to 1.000 mg/L (as Ag)	0.001 mg/L	±0.020 mg/L ±5% of reading at 25 °C	575 nm	Adaptation of the PAN Method	<b>HI93737-01</b> Reagents for 50 tests <b>HI93737-03</b> Reagents for 150 tests
Sulfate	0 to 150 mg/L (as SO <sub>4</sub> <sup>2-</sup> )	1 mg/L	±5 mg/L ±3% of reading at 25 °C	466 nm	Sulfate is precipitated with barium chloride crystals	<b>HI93751-01</b> Reagents for 100 tests <b>HI93751-03</b> Reagents for 300 tests
Surfactants, Anionic	0.00 to 3.50 mg/L (as SDBS)	0.01 mg/L	±0.04 mg/L ±3% of reading at 25 °C	610 nm	Adaptation of the EPA Method 425.1 and Standard Methods for the Examination of Water and Wastewater, 20th Edition, 5540C, Anionic Surfactants as MBAS	<b>HI95769-01</b> Reagents for 40 tests
Zinc	0.00 to 3.00 mg/L (as Zn)	0.01 mg/L	±0.03 mg/L ±3% of reading at 25 °C	575 nm	Adaptation of the Standard Methods for the Examination of Water and Wastewater, 18th Edition, Zincon Method	<b>HI93731-01</b> Reagents for 100 tests <b>HI93731-03</b> Reagents for 300 tests
<b>Ordering Information</b>	<b>HI83300-01</b> (115V) and <b>HI83300-02</b> (230V) is supplied with sample cuvette (4 pcs.), sample cuvette cap (4 pcs.), cloth for wiping cuvettes, scissors, USB cable, 5 Vdc power adapter, 60 mL glass bottle, instrument quality certificate, and instruction manual.					
<b>Standards</b>	<b>HI83300-11</b> CAL Check Cuvette Kit for HI83300					

HI83303

# Multiparameter Photometer

with Digital pH Electrode Input for Aquaculture

The HI83303 benchtop photometer measures 12 different key water quality parameters using 20 different methods. This photometer uses an LED, a narrow band interference filter, a focusing lens, and both a silicon photodetector for absorbance measurement and a reference detector to maintain a consistent light source to ensure accurate and repeatable photometric readings every time.

Made with the aquaculture industry in mind, the HI83303 is a comprehensive solution to maintaining optimal chemical and environmental conditions, preventing disease, and increasing production. The HI83303 measures vital parameters such as alkalinity, calcium, nitrite, and phosphate. Alkalinity plays a part in a dynamic relationship with pH and CO<sub>2</sub> concentrations, high alkalinity water lowers fluctuations in pH. The buffering capacity acts to store extra CO<sub>2</sub> essential for photosynthesis in ponds to produce oxygen. Maintaining calcium at certain levels is vital to proper fish growth and development. Excessive nitrite can be toxic to fish. When nitrite interacts with hemoglobin the iron becomes oxidized and blood cells can no longer carry oxygen. Phosphate is essential to plant growth; too much phosphate in an aquaculture system can contribute to algal blooms decreasing dissolved oxygen vital for a successful ecosystem.

## • Advanced optical system

- Innovative optical design that utilizes a reference detector and focusing lens to eliminate errors from changes in the light source and from imperfections in the glass cuvette

## • Backlit 128 x 64 Pixel Graphic LCD Display

- Backlit graphic display allows for easy viewing in low light conditions
- The 128 x 64 Pixel LCD allows for a simplified user interface with virtual keys and on-screen help to guide the user through use of the meter

## • Built-in Reaction Timer for Photometric Measurements

- The measurement is taken after the countdown timer expires.
- Countdown timer ensures that all readings are taken at the appropriate reaction intervals regardless of user for better consistency in measurements



## • Absorbance mode

- Hanna's exclusive CAL Check™ cuvettes for validation of light source and detector
- Allows for the user to plot concentration versus absorbance for a specific wavelength for use with user supplied chemistry or for teaching principles of photometry

## • Units of Measure

- Appropriate unit of measure along with chemical form is displayed along with reading

## • Result Conversion

- Automatically convert readings to other chemical forms with the touch of a button

## • Cuvette Cover

- Aids in preventing stray light from affecting measurements

## • Digital pH Electrode Input

- Measure pH and temperature with a single probe
- Good Laboratory Practice (GLP) to track calibration information including date, time, buffers used, offset and slope for traceability
- pH CAL Check™ alerts user to potential problems during the calibration process
- Space saving having a pH meter and photometer built into one meter

## • Battery Status Indicator

- Indicates the amount of battery life left

## • Data Logging

- Up to 1000 photometric and pH readings can be stored by simply pressing the dedicated LOG button. Logged readings are just as easily recalled by pressing the RCL button
- Sample ID and User ID information can be added to a logged reading using the alphanumeric keypad

## • Connectivity

- Logged readings can be quickly and easily transferred to a flash drive using the USB-A host port or to a computer using the micro USB-B port
- Data is exported as a .CSV file for use with common spreadsheet programs

## • Rechargeable Battery

- Li-polymer rechargeable battery lasts for 500 measurements or 50 hours of pH measurement

## • Error Messages

- Photometric error messages
- pH calibration messages include clean electrode, check buffer and check probe



HI83303-11

Parameter	Range	Resolution	Accuracy	Wavelength	Method	Reagent Code
Alkalinity	0 to 500 mg/L (as CaCO <sub>3</sub> )	1 mg/L	±5 mg/L ±5% of reading at 25 °C	610 nm	Bromocresol Green	<b>HI775-26</b> Reagents for 25 tests
Alkalinity, Marine	0 to 300 mg/L (as CaCO <sub>3</sub> )	1 mg/L	±5 mg/L ±5% of reading at 25 °C	610 nm	Bromocresol Green	<b>HI755-26</b> Reagents for 25 tests
Ammonia Low Range	0.00 to 3.00 mg/L (as NH <sub>3</sub> -N)	0.01 mg/L	±0.04 mg/L ±4% of reading at 25 °C	420 nm	Adaptation of the ASTM Manual of Water and Environmental Technology, D1426, Nessler Method	<b>HI93700-01</b> Reagents for 100 tests <b>HI93700-03</b> Reagents for 300 tests
Ammonia Medium Range	0.00 to 10.00 mg/L (as NH <sub>3</sub> -N)	0.01 mg/L	±0.05 mg/L ±5% of reading at 25 °C	420 nm	Adaptation of the ASTM Manual of Water and Environmental Technology, D1426, Nessler Method	<b>HI93715-01</b> Reagents for 100 tests <b>HI93715-03</b> Reagents for 300 tests
Ammonia High Range	0.0 to 100.0 mg/L (as NH <sub>3</sub> -N)	0.1 mg/L	±0.5 mg/L ±5% of reading at 25 °C	420 nm	Adaptation of the ASTM Manual of Water and Environmental Technology, D1426, Nessler Method	<b>HI93733-01</b> Reagents for 100 tests <b>HI93733-03</b> Reagents for 300 tests
Calcium	0 to 400 mg/L (as Ca <sup>2+</sup> )	1 mg/L	±10 mg/L ±5% of reading at 25 °C	466 nm	Adaptation of the Oxalate Method	<b>HI937521-01</b> Reagents for 50 tests <b>HI937521-03</b> Reagents for 150 tests
Calcium, Marine	200 to 600 mg/L (as Ca <sup>2+</sup> )	1 mg/L	±6% of reading at 25 °C	610 nm	Adaptation of the Zincon Method	<b>HI758-26</b> Reagents for 25 tests
Chlorine, Free	0.00 to 5.00 mg/L (as Cl <sub>2</sub> )	0.01 mg/L	±0.03 mg/L ±3% of reading at 25 °C	525 nm	Adaptation of the EPA DPD Method 330.5	<b>HI93701-F</b> Reagents for 300 tests (liquid) <b>HI93701-01</b> Reagents for 100 tests (powder) <b>HI93701-03</b> Reagents for 300 tests (powder)
Chlorine, Total	0.00 to 5.00 mg/L (as Cl <sub>2</sub> )	0.01 mg/L	±0.03 mg/L ±3% of reading at 25 °C	525 nm	Adaptation of the EPA DPD Method 330.5	<b>HI93701-T</b> Reagents for 300 tests (liquid) <b>HI93711-01</b> Reagents for 100 total tests (powder) <b>HI93711-03</b> Reagents for 300 total tests (powder)
Copper Low Range	0.000 to 1.500mg/L (as Cu <sup>2+</sup> )	0.001mg/L	±0.010mg/L ±5% of reading at 25 °C	575 nm	Adaptation of the EPA Method	<b>HI95747-01</b> Reagents for 100 tests <b>HI95747-03</b> Reagents for 300 tests
Copper High Range	0.00 to 5.00 mg/L (as Cu <sup>2+</sup> )	0.01 mg/L	±0.02 mg/L ±4% of reading at 25 °C	575 nm	Adaptation of the EPA Method	<b>HI93702-01</b> Reagents for 100 tests <b>HI93702-03</b> Reagents for 300 tests
Nitrate	0.0 to 30.0 mg/L (as NO <sub>3</sub> <sup>-</sup> -N)	0.1 mg/L	±0.5 mg/L ±10% of reading at 25 °C	525 nm	Adaptation of the Cadmium Reduction Method	<b>HI93728-01</b> Reagents for 100 tests <b>HI93728-03</b> Reagents for 300 tests
Nitrite, Marine Ultra Low Range	0 to 200 µg/L (as NO <sub>2</sub> <sup>-</sup> -N)	1 µg/L	±10 µg/L ±4% of reading at 25 °C	466 nm	Adaptation of the EPA Diazotization Method 354.1	<b>HI764-25</b> Reagents for 25 tests
Nitrite Low Range	0 to 600 µg/L (as NO <sub>2</sub> <sup>-</sup> -N)	1 µg/L	±20 µg/L ±4% of reading at 25 °C	466 nm	Adaptation of the EPA Diazotization Method 354.1	<b>HI93707-01</b> Reagents for 100 tests <b>HI93707-03</b> Reagents for 300 tests
Nitrite High Range	0 to 150 mg/L (as NO <sub>2</sub> <sup>-</sup> )	1 mg/L	±4 mg/L ±4% of reading at 25 °C	575 nm	Adaptation of the Ferrous Sulfate Method	<b>HI93708-01</b> Reagents for 100 tests <b>HI93708-03</b> Reagents for 300 tests
Oxygen, Dissolved	0.0 to 10.0 mg/L (as O <sub>2</sub> )	0.1 mg/L	±0.4 mg/L ±3% of reading at 25 °C	420 nm	Adaptation of the Standard Methods for the Examination of Water and Wastewater, 18th Edition, Azide Modified Winkler Method	<b>HI93732-01</b> Reagents for 100 tests <b>HI93732-03</b> Reagents for 300 tests
pH	6.5 to 8.5 pH	0.1 pH	±0.1 pH at 25 °C	525 nm	Adaptation of the Phenol Red Method	<b>HI93710-01</b> Reagents for 100 pH tests <b>HI93710-03</b> Reagents for 300 pH tests
Phosphate, Marine Ultra Low Range	0 to 200 µg/L (as P)	1 µg/L	±5 µg/L ±5% of reading at 25 °C	610 nm	Adaptation of Standard Methods for the Examination of Water and Wastewater, 20th Edition, Ascorbic Acid Method	<b>HI736-25</b> Reagents for 25 tests
Phosphate Low Range	0.00 to 2.50 mg/L (as PO <sub>4</sub> <sup>3-</sup> )	0.01 mg/L	±0.04 mg/L ±4% of reading at 25 °C	610 nm	Adaptation of the Ascorbic Acid Method	<b>HI93713-01</b> Reagents for 100 tests <b>HI93713-03</b> Reagents for 300 tests
Phosphate High Range	0.0 to 30.0 mg/L (as PO <sub>4</sub> <sup>3-</sup> )	0.1 mg/L	±1.0 mg/L ±4% of reading at 25 °C	525 nm	Adaptation of the Standard Methods for the Examination of Water and Wastewater, 18th Edition, Amino Acid Method	<b>HI93717-01</b> Reagents for 100 tests <b>HI93717-03</b> Reagents for 300 tests
<b>Ordering Information</b>	<b>HI83303-01</b> (115V) and <b>HI83303-02</b> (230V) is supplied with sample cuvette (4 pcs.), sample cuvette cap (4 pcs.), cloth for wiping cuvettes, scissors, USB cable, 5 Vdc power adapter, 60 mL glass bottle, instrument quality certificate, and Instruction manual.					
<b>Standards</b>	<b>HI83303-11</b> CAL Check Cuvette Kit for HI83303					

HI83305

# Multiparameter Photometer

with Digital pH Electrode Input  
for Boilers and Cooling Towers

The HI83305 benchtop photometer measures 18 different key water quality parameters using 32 different methods. This photometer features an innovative optical system that use an LED, a narrow band interference filter, a focusing lens, and both a silicon photodetector for absorbance measurement and a reference detector to maintain a consistent light source to ensure accurate and repeatable photometric readings every time.

Specially designed for use with boilers and cooling towers, the HI83305 is a comprehensive way to maintain precise water conditions within these systems. Problems such as corrosion, deposition, and microbial growth can occur if these key parameters, such as oxygen scavengers and silica, aren't maintained. Oxygen scavengers are added to remove residual dissolved oxygen in boiler feed water that can cause corrosion in a steam generating plant. It is important that levels of oxygen scavengers be routinely checked to prevent corrosion and ensure that equipment is working efficiently. Boiler water maintenance is necessary to prevent or control deposit formation as seen with silica. Silica contamination can reduce system efficiency and increase maintenance of equipment due to scaling.

#### • Advanced optical system

- Innovative optical design that utilizes a reference detector and focusing lens to eliminate errors from changes in the light source and from imperfections in the glass cuvette

#### • Backlit 128 x 64 Pixel Graphic LCD Display

- Backlit graphic display allows for easy viewing in low light conditions
- The 128 x 64 Pixel LCD allows for a simplified user interface with virtual keys and on-screen help to guide the user through use of the meter

#### • Built-in Reaction Timer for Photometric Measurements

- The measurement is taken after the countdown timer expires.
- Countdown timer ensures that all readings are taken at the appropriate reaction intervals regardless of user for better consistency in measurements



#### • Absorbance mode

- Hanna's exclusive CAL Check™ cuvettes for validation of light source and detector
- Allows for the user to plot concentration versus absorbance for a specific wavelength for use with user supplied chemistry or for teaching principles of photometry

#### • Units of Measure

- Appropriate unit of measure along with chemical form is displayed along with reading

#### • Result Conversion

- Automatically convert readings to other chemical forms with the touch of a button

#### • Cuvette Cover

- Aids in preventing stray light from affecting measurements

#### • Digital pH Electrode Input

- Measure pH and temperature with a single probe
- Good Laboratory Practice (GLP) to track calibration information including date, time, buffers used, offset and slope for traceability
- pH CAL Check™ alerts user to potential problems during the calibration process
- Space saving having a pH meter and photometer built into one meter

#### • Battery Status Indicator

- Indicates the amount of battery life left

#### • Data Logging

- Up to 1000 photometric and pH readings can be stored by simply pressing the dedicated LOG button. Logged readings are just as easily recalled by pressing the RCL button
- Sample ID and User ID information can be added to a logged reading using the alphanumeric keypad

#### • Connectivity

- Logged readings can be quickly and easily transferred to a flash drive using the USB-A host port or to a computer using the micro USB-B port
- Data is exported as a .CSV file for use with common spreadsheet programs

#### • Rechargeable Battery

- Li-polymer rechargeable battery lasts for 500 measurements or 50 hours of pH measurement

#### • Error Messages

- Photometric error messages
- pH calibration messages include clean electrode, check buffer and check probe





Parameter	Range	Resolution	Accuracy	Wavelength	Method	Reagent Code
Aluminum	0.00 to 1.00 mg/L (as Al <sup>3+</sup> )	0.01 mg/L	±0.04 mg/L ±4% of reading at 25 °C	525 nm	Adaptation of the Aluminon Method	<b>HI93712-01</b> Reagents for 100 tests <b>HI93712-03</b> Reagents for 300 tests
Ammonia Low Range	0.00 to 3.00 mg/L (as NH <sub>3</sub> -N)	0.01 mg/L	±0.04 mg/L ±4% of reading at 25 °C	420 nm	Adaptation of the ASTM Manual of Water and Environmental Technology, D1426 Nessler Method	<b>HI93700-01</b> Reagents for 100 tests <b>HI93700-03</b> Reagents for 300 tests
Ammonia Medium Range	0.00 to 10.00 mg/L (as NH <sub>3</sub> -N)	0.01 mg/L	±0.05 mg/L ±5% of reading at 25 °C	420 nm	Adaptation of the ASTM Manual of Water and Environmental Technology, D1426, Nessler Method	<b>HI93715-01</b> Reagents for 100 tests <b>HI93715-03</b> Reagents for 300 tests
Ammonia High Range	0.0 to 100.0 mg/L (as NH <sub>3</sub> -N)	0.1 mg/L	±0.5 mg/L ±5% of reading at 25 °C	420 nm	Adaptation of the ASTM Manual of Water and Environmental Technology, D1426, Nessler Method	<b>HI93733-01</b> Reagents for 100 tests <b>HI93733-03</b> Reagents for 300 tests
Bromine	0.00 to 8.00 mg/L (as Br <sub>2</sub> )	0.01 mg/L	±0.08 mg/L ±3% of reading at 25 °C	525 nm	Adaptation of the Standard Methods for the Examination of Water and Wastewater, 18th Edition, DPD Method	<b>HI93716-01</b> Reagents for 100 tests <b>HI93716-03</b> Reagents for 300 tests
Chlorine Dioxide	0.00 to 2.00 mg/L (as ClO <sub>2</sub> )	0.01 mg/L	±0.10 mg/L ±5% of reading at 25 °C	575 nm	Adaptation of the Chlorophenol Red Method	<b>HI93738-01</b> Reagents for 100 tests <b>HI93738-03</b> Reagents for 300 tests
Chlorine Dioxide (Rapid)	0.00 to 2.00 mg/L (as ClO <sub>2</sub> )	0.01 mg/L	±0.10 mg/L ±5% of reading at 25 °C	525 nm	Adaptation of Standard Methods for the Examination of Water and Wastewater, 18th Edition, 4500 ClO <sub>2</sub> D	<b>HI96779-01</b> Reagents for 100 tests <b>HI96779-03</b> Reagents for 300 tests
Chlorine, Free	0.00 to 5.00 mg/L (as Cl <sub>2</sub> )	0.01 mg/L	±0.03 mg/L ±3% of reading at 25 °C	525 nm	Adaptation of the EPA DPD Method 330.5	<b>HI93701-F</b> 300 tests (liquid) <b>HI93701-01</b> 100 tests (powder) <b>HI93701-03</b> 300 tests (powder) <b>HI93701-T</b> 300 tests (liquid)
Chlorine, Total	0.00 to 5.00 mg/L (as Cl <sub>2</sub> )	0.01 mg/L	±0.03 mg/L ±3% of reading at 25 °C	525 nm	Adaptation of the EPA DPD Method 330.5	<b>HI93711-01</b> 100 total tests (powder) <b>HI93711-03</b> 300 total tests (powder)
Chromium (VI) Low Range	0 to 300 µg/L (as Cr(VI))	1 µg/L	±10 µg/L ±4% of reading at 25 °C	525 nm	Adaptation of the ASTM Manual of Water and Environmental Technology, D1687 Diphenylcarbohydrazide Method	<b>HI93749-01</b> Reagents for 100 tests <b>HI93749-03</b> Reagents for 300 tests
Chromium (VI) High Range	0 to 1000 µg/L (as Cr(VI))	1 µg/L	±5 µg/L ±4% of reading at 25 °C	525 nm	Adaptation of the ASTM Manual of Water and Environmental Technology, D1687-92, Diphenylcarbohydrazide Method	<b>HI93723-01</b> Reagents for 100 tests <b>HI93723-03</b> Reagents for 300 tests
Copper Low Range	0.000 to 1.500 mg/L (as Cu <sup>2+</sup> )	0.001 mg/L	±0.010 mg/L ±5% of reading at 25 °C	575 nm	Adaptation of the EPA Method	<b>HI95747-01</b> Reagents for 100 tests <b>HI95747-03</b> Reagents for 300 tests
Copper High Range	0.00 to 5.00 mg/L (as Cu <sup>2+</sup> )	0.01 mg/L	±0.02 mg/L ±4% of reading at 25 °C	575 nm	Adaptation of the EPA Method	<b>HI93702-01</b> Reagents for 100 tests <b>HI93702-03</b> Reagents for 300 tests
Hydrazine	0 to 400 µg/L (as N <sub>2</sub> H <sub>4</sub> )	1 µg/L	±4% of full scale reading at 25 °C	466 nm	Adaptation of the ASTM Manual of Water and Environmental Technology, Method D1385, p-Dimethylaminobenzaldehyde Method	<b>HI93704-01</b> Reagents for 100 tests <b>HI93704-03</b> Reagents for 300 tests
Iron Low Range	0.000 to 1.600 mg/L (as Fe)	0.001 mg/L	±0.010 mg/L ±8% of reading at 25 °C	575 nm	Adaptation of the TPTZ Method	<b>HI93746-01</b> Reagents for 50 tests <b>HI93746-03</b> Reagents for 150 tests
Iron High Range	0.00 to 5.00 mg/L (as Fe)	0.01 mg/L	±0.04 mg/L ±2% of reading at 25 °C	525 nm	Adaptation of Standard Methods for the Examination of Water and Wastewater, 23rd Edition, 3500-Fe B, Phenanthroline Method	<b>HI93721-01</b> Reagents for 100 tests <b>HI93721-03</b> Reagents for 300 tests
Iron (II)	0.00 to 6.00 mg/L (as Fe <sup>2+</sup> )	0.01 mg/L	±0.10 mg/L ±2% of reading at 25 °C	525 nm	Adaptation of Standard Methods for the Examination of Water and Wastewater, 23rd Edition, 3500-Fe B, Phenanthroline Method	<b>HI96776-01</b> Reagents for 100 tests <b>HI96776-03</b> Reagents for 300 tests
Molybdenum	0.0 to 40.0 mg/L (as Mo <sup>6+</sup> )	0.1 mg/L	±0.3 mg/L ±5% of reading at 25 °C	420 nm	Adaptation of the Mercaptoacetic Acid Method	<b>HI93730-01</b> Reagents for 100 tests <b>HI93730-03</b> Reagents for 300 tests
Nitrate	0.0 to 30.0 mg/L (as NO <sub>3</sub> <sup>-</sup> -N)	0.1 mg/L	±0.5 mg/L ±10% of reading at 25 °C	525 nm	Adaptation of the Cadmium Reduction Method	<b>HI93728-01</b> Reagents for 100 tests <b>HI93728-03</b> Reagents for 300 tests
Nitrite Low Range	0 to 600 µg/L (as NO <sub>2</sub> <sup>-</sup> -N)	1 µg/L	±20 µg/L ±4% of reading at 25 °C	466 nm	Adaptation of the EPA Diazotization Method 354.1	<b>HI93707-01</b> Reagents for 100 tests <b>HI93707-03</b> Reagents for 300 tests
Nitrite High Range	0 to 150 mg/L (as NO <sub>2</sub> <sup>-</sup> )	1 mg/L	±4 mg/L ±4% of reading at 25 °C	575 nm	Adaptation of the Ferrous Sulfate Method	<b>HI93708-01</b> Reagents for 100 tests <b>HI93708-03</b> Reagents for 300 tests
Oxygen, Dissolved	0.0 to 10.0 mg/L (as O <sub>2</sub> )	0.1 mg/L	±0.4 mg/L ±3% of reading at 25 °C	420 nm	Adaptation of the Standard Methods for the Examination of Water and Wastewater, 18th Edition, Azide Modified Winkler Method	<b>HI93732-01</b> Reagents for 100 tests <b>HI93732-03</b> Reagents for 300 tests
Oxygen Scavengers (Carbohydrazide)	0.00 to 1.50 mg/L (as Carbohydrazide)	0.01 mg/L	±0.02 mg/L ±3% of reading at 25 °C	575 nm	Adaptation of the Iron Reduction Method	<b>HI96773-01</b> Reagents for 50 tests <b>HI96773-03</b> Reagents for 150 tests
Oxygen Scavengers (Diethylhydroxylamine) (DEHA)	0 to 1000 µg/L (as DEHA)	1 µg/L	±5 µg/L ±5% of reading at 25 °C	575 nm	Adaptation of the Iron Reduction Method	<b>HI96773-01</b> Reagents for 50 tests <b>HI96773-03</b> Reagents for 150 tests
Oxygen Scavengers (Hydroquinone)	0.00 to 2.50 mg/L (as Hydroquinone)	0.01 mg/L	±0.04 mg/L ±3% of reading at 25 °C	575 nm	Adaptation of Iron Reduction Method	<b>HI96773-01</b> Reagents for 50 tests <b>HI96773-03</b> Reagents for 150 tests
Oxygen Scavengers (Iso-ascorbic Acid)	0.00 to 4.50 mg/L (as Iso-Ascorbic Acid)	0.01 mg/L	±0.03 mg/L ±3% of reading at 25 °C	575 nm	Adaptation of the Iron Reduction Method	<b>HI96773-01</b> Reagents for 50 tests <b>HI96773-03</b> Reagents for 150 tests
pH	6.5 to 8.5 pH	0.1 pH	±0.1 pH at 25 °C	525 nm	Adaptation of the Phenol Red Method	<b>HI93710-01</b> Reagents for 100 pH tests <b>HI93710-03</b> Reagents for 300 pH tests
Phosphate Low Range	0.00 to 2.50 mg/L (as PO <sub>4</sub> <sup>3-</sup> )	0.01 mg/L	±0.04 mg/L ±4% of reading at 25 °C	610 nm	Adaptation of the Ascorbic Acid Method	<b>HI93713-01</b> Reagents for 100 tests <b>HI93713-03</b> Reagents for 300 tests
Phosphate High Range	0.0 to 30.0 mg/L (as PO <sub>4</sub> <sup>3-</sup> )	0.1 mg/L	±1.0 mg/L ±4% of reading at 25 °C	525 nm	Adaptation of the Standard Methods for the Examination of Water and Wastewater, 18th Edition, Amino Acid Method	<b>HI93717-01</b> Reagents for 100 tests <b>HI93717-03</b> Reagents for 300 tests
Silica Low Range	0.00 to 2.00 mg/L (as SiO <sub>2</sub> )	0.01 mg/L	±0.03 mg/L ±3% of reading at 25 °C	610 nm	Adaptation of the ASTM Manual of Water and Environmental Technology, D859, Heteropoly Molybdenum Blue Method	<b>HI93705-01</b> Reagents for 100 tests <b>HI93705-03</b> Reagents for 300 tests
Silica High Range	0 to 200 mg/L (as SiO <sub>2</sub> )	1 mg/L	±1 mg/L ±5% of reading at 25 °C	466 nm	Adaptation of the EPA Method 370.1 for Drinking, Surface and Saline Waters, Domestic and Industrial Wastes and Standard Method 4500-SiO <sub>2</sub>	<b>HI96770-01</b> Reagents for 100 tests <b>HI96770-03</b> Reagents for 300 tests
Zinc	0.00 to 3.00 mg/L (as Zn)	0.01 mg/L	±0.03 mg/L ±3% of reading at 25 °C	575 nm	Adaptation of the Standard Methods for the Examination of Water and Wastewater, 18th Edition, Zincon Method	<b>HI93731-01</b> Reagents for 100 tests <b>HI93731-03</b> Reagents for 300 tests
<b>Ordering Information</b>	<b>HI83305-01</b> (115V) and <b>HI83305-02</b> (230V) is supplied with sample cuvette (4 pcs.), sample cuvette cap (4 pcs.), cloth for wiping cuvettes, scissors, USB cable, 5 Vdc power adapter, 60 mL glass bottle, instrument quality certificate, and instruction manual.					
<b>Standards</b>	<b>HI83305-11</b> CAL Check Cuvette Kit for HI83305					

HI83306

# Multiparameter Photometer

with Digital pH Electrode Input  
for Environmental Analysis

The HI83306 benchtop photometer measures 16 different key water quality parameters using 23 different methods. This photometer features an innovative optical system that uses an LED, a narrow band interference filter, a focusing lens, and both a silicon photodetector for absorbance measurement and a reference detector to maintain a consistent light source to ensure accurate and repeatable photometric readings every time.

The HI83306 was developed to measure the most common parameters in environmental water quality monitoring. Nutrients such as nitrates and phosphates are key indicators of nutrient pollution from agricultural sources and are considered dangerous to environmental waters. Too few nutrients and waters will be unable to sustain healthy ecosystems; too many nutrients and algal blooms can form, which can be detrimental to water quality and aquatic health. Dissolved oxygen is an essential to performing biological processes for many forms of aquatic life, such as fish, plants and microorganisms.

## • Advanced optical system

- Innovative optical design that utilizes a reference detector and focusing lens to eliminate errors from changes in the light source and from imperfections in the glass cuvette

## • Backlit 128 x 64 Pixel Graphic LCD Display

- Backlit graphic display allows for easy viewing in low light conditions
- The 128 x 64 Pixel LCD allows for a simplified user interface with virtual keys and on-screen help to guide the user through use of the meter

## • Built-in Reaction Timer for Photometric Measurements

- The measurement is taken after the countdown timer expires.
- Countdown timer ensures that all readings are taken at the appropriate reaction intervals regardless of user for better consistency in measurements



Application Designed Photometers



## • Absorbance mode

- Hanna's exclusive CAL Check™ cuvettes for validation of light source and detector
- Allows for the user to plot concentration versus absorbance for a specific wavelength for use with user supplied chemistry or for teaching principles of photometry

## • Units of Measure

- Appropriate unit of measure along with chemical form is displayed along with reading

## • Result Conversion

- Automatically convert readings to other chemical forms with the touch of a button

## • Cuvette Cover

- Aids in preventing stray light from affecting measurements

## • Digital pH Electrode Input

- Measure pH and temperature with a single probe
- Good Laboratory Practice (GLP) to track calibration information including date, time, buffers used, offset and slope for traceability
- pH CAL Check™ alerts user to potential problems during the calibration process
- Space saving having a pH meter and photometer built into one meter

## • Battery Status Indicator

- Indicates the amount of battery life left

## • Data Logging

- Up to 1000 photometric and pH readings can be stored by simply pressing the dedicated LOG button. Logged readings are just as easily recalled by pressing the RCL button
- Sample ID and User ID information can be added to a logged reading using the alphanumeric keypad

## • Connectivity

- Logged readings can be quickly and easily transferred to a flash drive using the USB-A host port or to a computer using the micro USB-B port
- Data is exported as a .CSV file for use with common spreadsheet programs

## • Rechargeable Battery

- Li-polymer rechargeable battery lasts for 500 measurements or 50 hours of pH measurement

## • Error Messages

- Photometric error messages
- pH calibration messages include clean electrode, check buffer and check probe



HI83306-11

Parameter	Range	Resolution	Accuracy	Wavelength	Method	Reagent Code
Ammonia Low Range	0.00 to 3.00 mg/L (as NH <sub>3</sub> -N)	0.01 mg/L	±0.04 mg/L ±4% of reading at 25 °C	420 nm	Adaptation of the ASTM Manual of Water and Environmental Technology, D1426 Nessler Method	<b>HI93700-01</b> Reagents for 100 tests <b>HI93700-03</b> Reagents for 300 tests
Ammonia Medium Range	0.00 to 10.00 mg/L (as NH <sub>3</sub> -N)	0.01 mg/L	±0.05 mg/L ±5% of reading at 25 °C	420 nm	Adaptation of the ASTM Manual of Water and Environmental Technology, D1426, Nessler Method	<b>HI93715-01</b> Reagents for 100 tests <b>HI93715-03</b> Reagents for 300 tests
Ammonia High Range	0.0 to 100.0 mg/L (as NH <sub>3</sub> -N)	0.1 mg/L	±0.5 mg/L ±5% of reading at 25 °C	420 nm	Adaptation of the ASTM Manual of Water and Environmental Technology, D1426, Nessler Method	<b>HI93733-01</b> Reagents for 100 tests <b>HI93733-03</b> Reagents for 300 tests
Chlorine, Free	0.00 to 5.00 mg/L (as Cl <sub>2</sub> )	0.01 mg/L	±0.03 mg/L ±3% of reading at 25 °C	525 nm	Adaptation of the EPA DPD Method 330.5	<b>HI93701-F</b> Reagents for 300 tests (liquid) <b>HI93701-01</b> Reagents for 100 tests (powder) <b>HI93701-03</b> Reagents for 300 tests (powder)
Chlorine, Total	0.00 to 5.00 mg/L (as Cl <sub>2</sub> )	0.01 mg/L	±0.03 mg/L ±3% of reading at 25 °C	525 nm	Adaptation of the EPA DPD Method 330.5	<b>HI93701-T</b> Reagents for 300 tests (liquid) <b>HI93711-01</b> Reagents for 100 total tests (powder) <b>HI93711-03</b> Reagents for 300 total tests (powder)
Chromium (VI) Low Range	0 to 300 µg/L (as Cr(VI))	1 µg/L	±10 µg/L ±4% of reading at 25 °C	525 nm	Adaptation of the ASTM Manual of Water and Environmental Technology, D1687 Diphenylcarbohydrazide Method	<b>HI93749-01</b> Reagents for 100 tests <b>HI93749-03</b> Reagents for 300 tests
Chromium (VI) High Range	0 to 1000 µg/L (as Cr(VI))	1 µg/L	±5 µg/L ±4% of reading at 25 °C	525 nm	Adaptation of the ASTM Manual of Water and Environmental Technology, D1687-92, Diphenylcarbohydrazide Method	<b>HI93723-01</b> Reagents for 100 tests <b>HI93723-03</b> Reagents for 300 tests
Color of Water	0 to 500 PCU (Platinum Cobalt Units)	1 PCU	±10 PCU ±5% of reading at 25 °C	420 nm	Adaptation of the Standard Methods for the Examination of Water and Wastewater, 18th Edition, Colorimetric Platinum Cobalt Method	-
Copper Low Range	0.000 to 1.500mg/L (as Cu <sup>2+</sup> )	0.001mg/L	±0.010mg/L ±5% of reading at 25 °C	575 nm	Adaptation of the EPA Method	<b>HI95747-01</b> Reagents for 100 tests <b>HI95747-03</b> Reagents for 300 tests
Copper High Range	0.00 to 5.00 mg/L (as Cu <sup>2+</sup> )	0.01 mg/L	±0.02 mg/L ±4% of reading at 25 °C	575 nm	Adaptation of the EPA Method	<b>HI93702-01</b> Reagents for 100 tests <b>HI93702-03</b> Reagents for 300 tests
Cyanuric Acid	0 to 80 mg/L (as CYA)	1 mg/L	±1 mg/L ±15% of reading at 25 °C	525 nm	Adaptation of the Turbidimetric Method	<b>HI93722-01</b> Reagents for 100 tests <b>HI93722-03</b> Reagents for 300 tests
Molybdenum	0.0 to 40.0 mg/L (as Mo <sup>6+</sup> )	0.1 mg/L	±0.3 mg/L ±5% of reading at 25 °C	420 nm	Adaptation of the Mercuric Acid Method	<b>HI93730-01</b> Reagents for 100 tests <b>HI93730-03</b> Reagents for 300 tests
Nickel Low Range	0.000 to 1.000 mg/L (as Ni)	0.001 mg/L	±0.010 mg/L ±7% of reading at 25 °C	575 nm	Adaptation of the PAN Method	<b>HI93740-01</b> Reagents for 50 tests <b>HI93740-03</b> Reagents for 150 tests
Nickel High Range	0.00 to 7.00 g/L (as Ni)	0.01 g/L	±0.07 g/L ±4% of reading at 25 °C	575 nm	Adaptation of the Photometric Method	<b>HI93726-01</b> Reagents for 100 tests <b>HI93726-03</b> Reagents for 300 tests
Nitrate	0.0 to 30.0 mg/L (as NO <sub>3</sub> <sup>-</sup> -N)	0.1 mg/L	±0.5 mg/L ±10% of reading at 25 °C	525 nm	Adaptation of the Cadmium Reduction Method	<b>HI93728-01</b> Reagents for 100 tests <b>HI93728-03</b> Reagents for 300 tests
Nitrite High Range	0 to 150 mg/L (as NO <sub>2</sub> <sup>-</sup> )	1 mg/L	±4 mg/L ±4% of reading at 25 °C	575 nm	Adaptation of the Ferrous Sulfate Method	<b>HI93708-01</b> Reagents for 100 tests <b>HI93708-03</b> Reagents for 300 tests
Oxygen, Dissolved	0.0 to 10.0 mg/L (as O <sub>2</sub> )	0.1 mg/L	±0.4 mg/L ±3% of reading at 25 °C	420 nm	Adaptation of the Standard Methods for the Examination of Water and Wastewater, 18th Edition, Azide Modified Winkler Method	<b>HI93732-01</b> Reagents for 100 tests <b>HI93732-03</b> Reagents for 300 tests
pH	6.5 to 8.5 pH	0.1 pH	±0.1 pH at 25 °C	525 nm	Adaptation of the Phenol Red Method	<b>HI93710-01</b> Reagents for 100 pH tests <b>HI93710-03</b> Reagents for 300 pH tests
Phosphate Low Range	0.00 to 2.50 mg/L (as PO <sub>4</sub> <sup>3-</sup> )	0.01 mg/L	±0.04 mg/L ±4% of reading at 25 °C	610 nm	Adaptation of the Ascorbic Acid Method	<b>HI93713-01</b> Reagents for 100 tests <b>HI93713-03</b> Reagents for 300 tests
Phosphate High Range	0.0 to 30.0 mg/L (as PO <sub>4</sub> <sup>3-</sup> )	0.1 mg/L	±1.0 mg/L ±4% of reading at 25 °C	525 nm	Adaptation of the Standard Methods for the Examination of Water and Wastewater, 18th Edition, Amino Acid Method	<b>HI93717-01</b> Reagents for 100 tests <b>HI93717-03</b> Reagents for 300 tests
Silica Low Range	0.00 to 2.00 mg/L (as SiO <sub>2</sub> )	0.01 mg/L	±0.03 mg/L ±3% of reading at 25 °C	610 nm	Adaptation of the ASTM Manual of Water and Environmental Technology, D859, Heteropoly Molybdenum Blue Method	<b>HI93705-01</b> Reagents for 100 tests <b>HI93705-03</b> Reagents for 300 tests
Silver	0.000 to 1.000 mg/L (as Ag)	0.001 mg/L	±0.020 mg/L ±5% of reading at 25 °C	575 nm	Adaptation of the PAN Method	<b>HI93737-01</b> Reagents for 50 tests <b>HI93737-03</b> Reagents for 150 tests
Zinc	0.00 to 3.00 mg/L (as Zn)	0.01 mg/L	±0.03 mg/L ±3% of reading at 25 °C	575 nm	Adaptation of the Standard Methods for the Examination of Water and Wastewater, 18th Edition, Zincon Method	<b>HI93731-01</b> Reagents for 100 tests <b>HI93731-03</b> Reagents for 300 tests

**Ordering Information**

**HI83306-01** (115V) and **HI83306-02** (230V) is supplied with sample cuvette (4 pcs.), sample cuvette cap (4 pcs.), cloth for wiping cuvettes, scissors, USB cable, 5 Vdc power adapter, 60 mL glass bottle, instrument quality certificate, and instruction manual.

**Standards**

**HI83306-11** CAL Check Cuvette Kit for HI83306

HI83325

# Multiparameter Photometer

with Digital pH Electrode Input  
for Nutrient Analysis

The HI83325 benchtop photometer measures 8 different key water quality parameters using 10 different methods. This photometer features an innovative optical system that uses an LED, a narrow band interference filter, a focusing lens, and both a silicon photodetector for absorbance measurement and a reference detector to maintain a consistent light source to ensure accurate and repeatable photometric readings every time.

Consistent and thorough monitoring of plant nutrients is essential to maintaining healthy growth and reproduction. This is easy with the HI83325, a comprehensive way to monitor vital plant nutrients such as potassium, calcium and magnesium. Required in large quantities, potassium plays a vital role in water uptake and enzyme regulation. Calcium helps to strengthen plant cell walls protecting against heat stress while magnesium helps build a strong immune system.

## • Advanced optical system

- Innovative optical design that utilizes a reference detector and focusing lens to eliminate errors from changes in the light source and from imperfections in the glass cuvette

## • Backlit 128 x 64 Pixel Graphic LCD Display

- Backlit graphic display allows for easy viewing in low light conditions
- The 128 x 64 Pixel LCD allows for a simplified user interface with virtual keys and on-screen help to guide the user through use of the meter

## • Built-in Reaction Timer for Photometric Measurements

- The measurement is taken after the countdown timer expires.
- Countdown timer ensures that all readings are taken at the appropriate reaction intervals regardless of user for better consistency in measurements



## • Absorbance mode

- Hanna's exclusive CAL Check™ cuvettes for validation of light source and detector
- Allows for the user to plot concentration versus absorbance for a specific wavelength for use with user supplied chemistry or for teaching principles of photometry

## • Units of Measure

- Appropriate unit of measure along with chemical form is displayed along with reading

## • Result Conversion

- Automatically convert readings to other chemical forms with the touch of a button

## • Cuvette Cover

- Aids in preventing stray light from affecting measurements

## • Digital pH Electrode Input

- Measure pH and temperature with a single probe
- Good Laboratory Practice (GLP) to track calibration information including date, time, buffers used, offset and slope for traceability
- pH CAL Check™ alerts user to potential problems during the calibration process
- Space saving having a pH meter and photometer built into one meter

## • Battery Status Indicator

- Indicates the amount of battery life left

## • Data Logging

- Up to 1000 photometric and pH readings can be stored by simply pressing the dedicated LOG button. Logged readings are just as easily recalled by pressing the RCL button
- Sample ID and User ID information can be added to a logged reading using the alphanumeric keypad

## • Connectivity

- Logged readings can be quickly and easily transferred to a flash drive using the USB-A host port or to a computer using the micro USB-B port
- Data is exported as a .CSV file for use with common spreadsheet programs

## • Rechargeable Battery

- Li-polymer rechargeable battery lasts for 500 measurements or 50 hours of pH measurement

## • Error Messages

- Photometric error messages
- pH calibration messages include clean electrode, check buffer and check probe



HI83325-11



## Supplied Complete

HI83225 is supplied with the HI83300-100 in a rugged carrying case.

Parameter	Range	Resolution	Accuracy	Wavelength	Method	Reagent Code
Ammonia Low Range	0.00 to 3.00 mg/L (as NH <sub>3</sub> -N)	0.01 mg/L	±0.04 mg/L ±4% of reading at 25 °C	420 nm	Adaptation of the ASTM Manual of Water and Environmental Technology, D1426 Nessler Method	<b>HI93700-01</b> Reagents for 100 tests <b>HI93700-03</b> Reagents for 300 tests
Ammonia Medium Range	0.00 to 10.00 mg/L (as NH <sub>3</sub> -N)	0.01 mg/L	±0.05 mg/L ±5% of reading at 25 °C	420 nm	Adaptation of the ASTM Manual of Water and Environmental Technology, D1426, Nessler Method	<b>HI93715-01</b> Reagents for 100 tests <b>HI93715-03</b> Reagents for 300 tests
Ammonia High Range	0.0 to 100.0 mg/L (as NH <sub>3</sub> -N)	0.1 mg/L	±0.5 mg/L ±5% of reading at 25 °C	420 nm	Adaptation of the ASTM Manual of Water and Environmental Technology, D1426, Nessler Method	<b>HI93733-01</b> Reagents for 100 tests <b>HI93733-03</b> Reagents for 300 tests
Calcium	0 to 400 mg/L (as Ca <sup>2+</sup> )	1 mg/L	±10 mg/L ±5% of reading at 25 °C	466 nm	Adaptation of the Oxalate Method	<b>HI937521-01</b> Reagents for 50 tests <b>HI937521-03</b> Reagents for 150 tests
Iron Low Range	0.000 to 1.600 mg/L (as Fe)	0.001 mg/L	±0.010 mg/L ±8% of reading at 25 °C	575 nm	Adaptation of the TPTZ Method	<b>HI93746-01</b> Reagents for 50 tests <b>HI93746-03</b> Reagents for 150 tests
Iron High Range	0.00 to 5.00 mg/L (as Fe)	0.01 mg/L	±0.04 mg/L ±2% of reading at 25 °C	525 nm	Adaptation of Standard Methods for the Examination of Water and Wastewater, 23rd Edition, 3500-Fe B, Phenanthroline Method	<b>HI93721-01</b> Reagents for 100 tests <b>HI93721-03</b> Reagents for 300 tests
Iron(II)/(III)	0.00 to 6.00 mg/L (as Fe)	0.01 mg/L	±0.10 mg/L ±2% of reading at 25 °C	525 nm	Adaptation of Standard Methods for the Examination of Water and Wastewater, 23rd Edition, 3500-Fe B, Phenanthroline Method	<b>HI96777-01</b> Reagents for 100 tests <b>HI96777-03</b> Reagents for 300 tests
Magnesium	0 to 150 mg/L (as Mg <sup>2+</sup> )	1 mg/L	±5 mg/L ±3% of reading at 25 °C	466 nm	Adaptation of the Calmagite Method	<b>HI937520-01</b> Reagents for 50 tests <b>HI937520-03</b> Reagents for 150 tests
Nitrate	0.0 to 30.0 mg/L (as NO <sub>3</sub> <sup>-</sup> -N)	0.1 mg/L	±0.5 mg/L ±10% of reading at 25 °C	525 nm	Adaptation of the Cadmium Reduction Method	<b>HI93728-01</b> Reagents for 100 tests <b>HI93728-03</b> Reagents for 300 tests
Phosphate High Range	0.0 to 30.0 mg/L (as PO <sub>4</sub> <sup>3-</sup> )	0.1 mg/L	±1.0 mg/L ±4% of reading at 25 °C	525 nm	Adaptation of the Standard Methods for the Examination of Water and Wastewater, 18th Edition, Amino Acid Method	<b>HI93717-01</b> Reagents for 100 tests <b>HI93717-03</b> Reagents for 300 tests
Potassium	0.0 to 20.0 mg/L (as K)	0.1 mg/L	±3 mg/L ±7% of reading at 25 °C	466 nm	Adaptation of the Turbidimetric Tetraphenylborate Method	<b>HI93750-01</b> Reagents for 100 tests <b>HI93750-03</b> Reagents for 300 tests
Sulfate	0 to 150 mg/L (as SO <sub>4</sub> <sup>2-</sup> )	1 mg/L	±5 mg/L ±3% of reading at 25 °C	466 nm	Sulfate is precipitated with barium chloride crystals	<b>HI93751-01</b> Reagents for 100 tests <b>HI93751-03</b> Reagents for 300 tests

### Ordering Information

**HI83325-01** (115V) and **HI83325-02** (230V) is supplied with sample cuvette (4 pcs.), sample cuvette cap (4 pcs.), cloth for wiping cuvettes, scissors, 100 mL plastic graduated beaker with cap, 170 mL plastic graduated beaker, 3 mL plastic pipette, 5 mL graduated syringe, 60 mL graduated syringe, graduated cylinder, spoon, funnel, filter paper, demineralizer bottle for 10 L of water, activated carbon for 50 tests, USB cable, 5 Vdc power adapter, instrument quality certificate, and instruction manual.

### Standards

**HI83325-11** CAL Check Cuvette Kit for HI83325

HI83900

## Suction Lysimeter

for Root Level Soil Monitoring

- The perfect companion to the HI83325
- Monitor soil nutrients at the roots

The HI83900 suction lysimeter is built with a porous ceramic cap connected to a transparent tube for soil solution extraction. A rubber capillary is inserted in the tube passing through a rubber cap and reaching the ceramic tip.

The HI83900 series lysimeter is an ideal tool for collecting soil solution samples and then performing quantitative chemical analysis. In this way, the operator can easily monitor the level of nutrients such as ammonia, nitrate, phosphorous, potassium, sulfate, calcium, and magnesium.

The ceramic tip of the lysimeter can be used in all types of soil. It is made of a sinterized material that does not react with the nutrients in the soil. Therefore, the soil solution collected is not affected by the chemical composition of the ceramic cap resulting in precise and reliable tests.

The HI83900 allows the extraction of a solution from the soil by creating a vacuum inside the sampler tube, that exceeds the soil water tension. This will establish an hydraulic gradient for the solution to flow through the porous ceramic cap and into the lysimeter tube. Typically, a vacuum of about -60 cb (centibar) should be drawn.

For better monitoring of soil solution composition throughout an entire growth period of a crop, at least two lysimeters should be installed in the root zone of a representative plant, one at the upper part and one in the lower part of the root zone.

For better measurement accuracy and repeatability, it is recommended to replicate installations in at least two more locations.

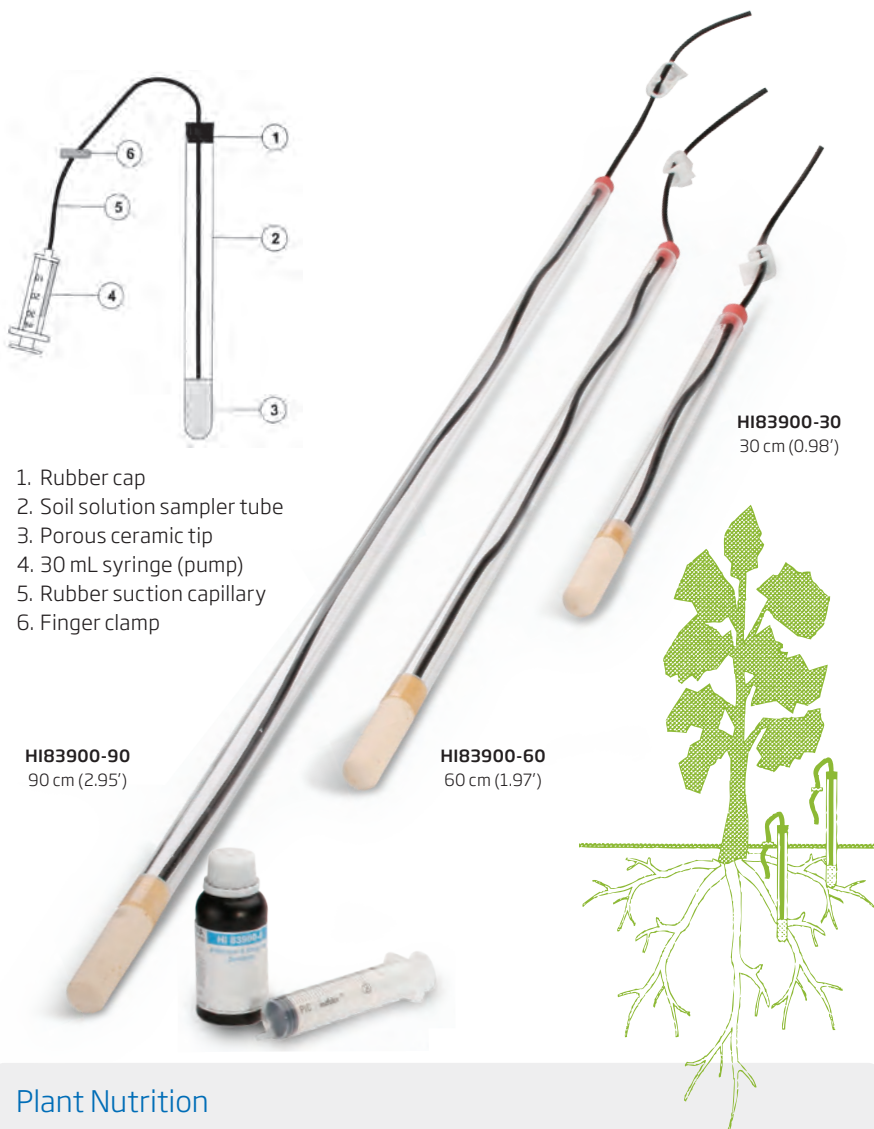

1. Rubber cap
2. Soil solution sampler tube
3. Porous ceramic tip
4. 30 mL syringe (pump)
5. Rubber suction capillary
6. Finger clamp

**HI83900-90**  
90 cm (2.95')

**HI83900-60**  
60 cm (1.97')

**HI83900-30**  
30 cm (0.98')

### Plant Nutrition

The three elements that are most needed by plants are nitrogen (N), phosphorous (P), and potassium (K).

Nitrogen is indispensable for the plant's life and is a key factor in fertilization. Nitrogen allows the development of the vegetative growth of the plant; in particular, it contributes to lengthening of trunks and sprouts and increases the production of foliage and fruits. An excess of nitrogen weakens the plants structure creating an unbalanced relationship between the leaves and the stalks. In addition, the plant becomes less resistant to diseases.

Phosphorous is an important element in the composition of DNA and RNA, the regulators of the energetic exchange (ATP and ADP), as well as the reserve substances in seeds and bulbs. It contributes to the formation of buds, roots, blooming, and lignification. A lack of phosphorous results in: stifling of plants, slow growth, a reduction of production, smaller fruits and a lower expansion of the roots.

Even though potassium is not a constituent of important compounds, it plays a remarkable role in many physiological activities in plants like the control of cellular turgor and the accumulation of carbohydrates. It increases the size of fruits, their flavor, as well as yielding a positive effect on the color and fragrance of flowers. Potassium also makes plants more resistant to disease.

#### Ordering Information

All include capillary rubber tube with rubber cap and finger clamp, cleaning solution starter kit (120 mL), 30 mL syringe and instructions

**HI83900-30** is comprised of 30 cm (0.98') sampler tube ending with porous ceramic tip.

**HI83900-60** is comprised of 60 cm (1.97') sampler tube ending with porous ceramic tip.

**HI83900-90** is comprised of 90 cm (2.95') sampler tube ending with porous ceramic tip.

#### Accessories

**HI83900-25** cleaning solution kit, 500 mL



## Residual Disinfection and pH Control

In swimming pool treatment, disinfection or sanitization is essential to rid the pool of bacteria and control nuisance organisms like algae which may occur in the pool, filtration equipment, and piping.

There are a number of available disinfectant compounds available, including chlorine, bromine and ozone dosing systems, of which chlorine is the most common.

## Chlorine

Chlorine is a strong oxidizing agent that destroys organic pollutants and bacteria. Part of the chlorine combines with compounds containing nitrogen forming chloramines, while the rest remains active, continuing its disinfecting action.

Combined chlorine is the quantity of chlorine that has already combined with nitrogen containing compounds. It is much less effective as a disinfectant than free chlorine. The addition of combined chlorine, and free chlorine gives total chlorine. A pool manager needs to aim for the perfect balance where free and total chlorine are proportionally equal, and thus to keep the combined chlorine levels near zero. The presence of chloramines is undesirable because of the distinctive 'swimming pool smell' as well as irritation to the eyes and mucous membranes caused by combined chlorines like dichloramines.

Commercial chlorine for disinfection may be available as a gas ( $\text{Cl}_2$ ), a liquid like sodium hypochlorite or bleach ( $\text{NaOCl}$ ) or in a solid state like calcium hypochlorite, chlorohydrantoin or chlorocyanuric acid compounds. These compounds, once dissolved in water, establish equilibrium between the hypochlorous acid ( $\text{HOCl}$ ) and

the hypochlorite ions ( $\text{OCl}^-$ ). Although both forms are considered free chlorine, it is the hypochlorous acid that provides the strongest disinfecting and oxidizing characteristic of chlorine solutions. The amount of hypochlorous acid in chlorinated water depends upon the pH value of the solution. Changes in pH value will effect the  $\text{HOCl}$  equilibrium in relation to the hydrogen and hypochlorite ions.

As depicted by the graph,  $\text{HOCl}$  decreases and  $\text{OCl}^-$  increases as pH increases. At a low pH, almost all the free chlorine is in the molecular form  $\text{HOCl}$ , and at a pH of around 7.5, the ratio between  $\text{HOCl}$  and  $\text{OCl}^-$  is 50:50. Since the ionic form  $\text{OCl}^-$  is a slow acting sanitizer while the molecular  $\text{HOCl}$  is fast acting, it is important to measure pH regularly. As a general rule a pH of about 7.2 is recommended to maintain fast acting disinfection conditions.

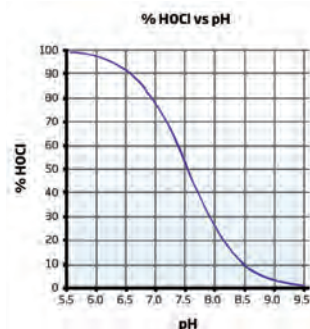

## Bromine

In many countries bromine sanitizing has been introduced as an alternative for chlorine, although it is not as strong. The advantage of bromine lies in its stability at higher temperatures (advantageous for heated pools and hot tubs), and its maintained disinfection power at a higher pH. Furthermore, there is very little reaction between bromine and nitrogen compounds reducing the unpleasant odor, and eye irritation problems. The main disadvantage of bromine is the slower acting disinfecting power, making it less suitable for larger pools.



## Ozone

Ozone is a very strong oxidizing agent that destroys organic compounds that are especially difficult to oxidize. It allows the pool manager to very efficiently remove combined chlorine without frequently refreshing large amounts of pool water. By the time the water passes through the filter units, ozone has already completed sanitizing, and it is not effected by the pH level.

Mainly because of its strong oxidizing power, the return water may contain trace concentrations of ozone. It is imperative to know that ozone is very unstable, so to ensure thorough sanitization of the water, low-level chlorination remains necessary.

## The Water Balance and Langelier Index

Pool water characteristics need to be maintained in a balanced state to avoid numerous issues. Measuring certain variables is extremely important to predict if the water is corrosive or will cause scaling.

A saturation index developed by Dr. Wilfred Langelier is widely used to predict the balance of swimming pool waters. It represents the estimation of a solution's ability to dissolve or precipitate calcium carbonate deposits. A certain level of this precipitation (filming) is desired to insulate pipes and boilers from contact with water. When no protective filming is formed, water is considered to be corrosive. On the other hand, too much filming can develop into scaling and incrustation of the pipes.

In the treatment and monitoring of pool water, the pool manager must ensure that related parameters such as alkalinity, hardness, and pH are carefully monitored in addition to sanitizing chemicals.

## Calcium

The presence of calcium in the system is desired to ensure filming on those places where the temperature is relatively high, like in boilers and pipes transporting warm water. Scaling must be avoided because it reduces heat transfer and pump capacity, and causes cloudiness in the water.

It is recommended to maintain the calcium hardness value within the range from 200 to 400 ppm as calcium carbonate ( $\text{CaCO}_3$ ).

## Alkalinity

Alkalinity is the measure of the total concentration of alkaline substances, mostly bicarbonates, dissolved in the water. The higher the alkalinity, the more resistant the water is to pH change. At the same time, high alkaline water is a major contributor to scaling problems like incrustation in filtration equipment, pumps, and piping.

It is recommended to maintain the alkalinity value within the range from 80 to 125 ppm as calcium carbonate ( $\text{CaCO}_3$ ).

## pH

The pH of the water is an important factor since at lower pH levels the corrosion rate increases. If the alkalinity values are sufficiently high, it will not be difficult to control the pH. Most pool managers prefer to keep the pH between 7.2 and 7.4 to best maintain low corrosion rates and a sufficient activity of chlorine.



## Langelier Index

The Langelier Index is a powerful tool to calculate the water balance, and to predict corrosion or scaling problems. Theoretically, a LI of zero indicates perfect water condition for swimming pools. If  $LI > 0$ , scaling and staining of the water is present, and if  $LI < 0$  the water is corrosive and highly irritating. A tolerance of  $\pm 0.4$  is normally acceptable.

The Langelier formula is expressed as:  $LI = pH + TF + HF + AF - 12.5$

Where:

**LI = Langelier Index (also called Saturation Index)**

**pH = pH of the water**

**TF = temperature factor**

**HF = hardness factor, log (Ca hardness, ppm as  $CaCO_3$ )**

**AF = alkalinity factor, log (alkalinity, ppm as  $CaCO_3$ )**

To calculate the exact Langelier Index of your water please use the **WATER INDEX** reference tables.

For most pools, water is balanced if:

- The pH value is maintained within the recommended ranges of pH 7.2 - 7.6
- Ideally, the Alkalinity should be maintained within a range of 80 - 125 ppm
- The Calcium Hardness should be maintained within a range of 200 - 400 ppm.

To calculate your water balance, three parameters must be measured; calcium hardness, alkalinity and pH. Find the hardness and alkalinity factor in the reference tables below.

The water temperature is, in general, maintained between 24°C (76°F) and 34°C (94°F). Assuming the temperature is kept within those ranges, an average value of 0.7 may be used.

### Water balance = $pH + TF + HF + AF$

Water Balance	Condition	Recommendation
11.0-12.0	Corrosive	Increase pH and/or alkalinity
12.1-12.3	Acceptable Balance	Retest water frequently
12.4-12.6	Ideal Balance	Maintain
12.7-12.9	Acceptable Balance	Retest water frequently
13.0-14.0	Scale Forming	Reduce pH and/or alkalinity

### Water Index Reference Table

Temperature			Calcium Hardness		Alkalinity	
°C	°F	TF	mg/L (as $CaCO_3$ )	HF	mg/L (as $CaCO_3$ )	AF
0	32	0	5	0.7	5	0.7
4	39	0.1	25	1.4	25	1.4
8	46	0.2	50	1.7	50	1.7
12	54	0.3	75	1.9	75	1.9
16	60	0.4	100	2.0	100	2.0
20	68	0.5	150	2.2	150	2.2
24	75	0.6	200	2.3	200	2.3
28	82	0.7	250	2.4	250	2.4
32	90	0.7	300	2.5	300	2.5
36	97	0.8	400	2.6	400	2.6
40	104	0.9	500	2.7	500	2.7
50	122	1.0	1000	3.0	1000	3.0



HI83326

## Multiparameter Photometer

with Digital pH Electrode Input  
for Pool and Spa Applications

The HI83326 benchtop photometer measures 12 different key water quality parameters using 14 different methods. This photometer features an innovative optical system that uses an LED, a narrow band interference filter, a focusing lens, and both a silicon photodetector for absorbance measurement and a reference detector to maintain a consistent light source to ensure accurate and repeatable photometric readings every time.

Made with the pool and spa industry in mind, a basic necessity of pool water treatment is to maintain the water in a safe and pleasant condition for the swimmers. In pool and spa water treatment, disinfection is essential to rid the pool of bacteria and control nuisance organisms like algae which may occur in the pool, spa, filtration equipment, or piping. There are a number of available disinfectant compounds including chlorine, bromine, and ozone. In order to achieve ideal water conditions, water requires testing on a daily and sometimes hourly basis to ensure there is enough residual disinfectant and to maintain pH levels. Equally important is calcium hardness and alkalinity; these levels should be monitored weekly to ensure the pool or spa water is well balanced to avoid corrosion and scale formation.

- **Advanced optical system**
  - Innovative optical design that utilizes a reference detector and focusing lens to eliminate errors from changes in the light source and from imperfections in the glass cuvette
- **Backlit 128 x 64 Pixel Graphic LCD Display**
  - Backlit graphic display allows for easy viewing in low light conditions
  - The 128 x 64 Pixel LCD allows for a simplified user interface with virtual keys and on-screen help to guide the user through use of the meter



- **Built-in Reaction Timer for Photometric Measurements**
  - The measurement is taken after the countdown timer expires.
  - Countdown timer ensures that all readings are taken at the appropriate reaction intervals regardless of user for better consistency in measurements
- **Absorbance mode**
  - Hanna's exclusive CAL Check™ cuvettes for validation of light source and detector
  - Allows for the user to plot concentration versus absorbance for a specific wavelength for use with user supplied chemistry or for teaching principles of photometry
- **Units of Measure**
  - Appropriate unit of measure along with chemical form is displayed along with reading
- **Result Conversion**
  - Automatically convert readings to other chemical forms with the touch of a button
- **Data Logging**
  - Up to 1000 photometric and pH readings can be stored by simply pressing the dedicated LOG button. Logged readings are just as easily recalled by pressing the RCL button
- Sample ID and User ID information can be added to a logged reading using the alphanumeric keypad
- **Connectivity**
  - Logged readings can be quickly and easily transferred to a flash drive using the USB-A host port or to a computer using the micro USB-B port
  - Data is exported as a .CSV file for use with common spreadsheet programs
- **Cuvette Cover**
  - Aids in preventing stray light from affecting measurements
- **Rechargeable Battery**
  - Li-polymer rechargeable battery lasts for 500 measurements or 50 hours of pH measurement
- **Battery Status Indicator**
  - Indicates the amount of battery life left
- **Error Messages**
  - Photometric error messages
  - pH calibration messages include clean electrode, check buffer and check probe



HI83326-11

#### • Digital pH Electrode Input

- Measure pH and temperature with a single probe
- Good Laboratory Practice (GLP) to track calibration information including date, time, buffers used, offset and slope for traceability
- pH CAL Check™ alerts user to potential problems during the calibration process
- Space saving having a pH meter and photometer built into one meter



Parameter	Range	Resolution	Accuracy	Wavelength	Method	Reagent Code
Alkalinity	0 to 500 mg/L (as CaCO <sub>3</sub> )	1 mg/L	±5 mg/L ±5% of reading at 25 °C	610 nm	Bromocresol Green	<b>HI775-26</b> Reagents for 25 tests
Bromine	0.00 to 8.00 mg/L (as Br <sub>2</sub> )	0.01 mg/L	±0.08 mg/L ±3% of reading at 25 °C	525 nm	Adaptation of the Standard Methods for the Examination of Water and Wastewater, 18th Edition, DPD Method	<b>HI93716-01</b> Reagents for 100 tests <b>HI93716-03</b> Reagents for 300 tests
Chlorine Dioxide	0.00 to 2.00 mg/L (as ClO <sub>2</sub> )	0.01 mg/L	±0.10 mg/L ±5% of reading at 25 °C	575 nm	Adaptation of the Chlorophenol Red Method	<b>HI93738-01</b> Reagents for 100 tests <b>HI93738-03</b> Reagents for 300 tests
Chlorine Dioxide (Rapid)	0.00 to 2.00 mg/L (as ClO <sub>2</sub> )	0.01 mg/L	±0.10 mg/L ±5% of reading at 25 °C	525 nm	Adaptation of Standard Methods for the Examination of Water and Wastewater, 18th Edition, 4500 ClO <sub>2</sub> D	<b>HI96779-01</b> Reagents for 100 tests <b>HI96779-03</b> Reagents for 300 tests
Chlorine, Free	0.00 to 5.00 mg/L (as Cl <sub>2</sub> )	0.01 mg/L	±0.03 mg/L ±3% of reading at 25 °C	525 nm	Adaptation of the EPA DPD Method 330.5	<b>HI93701-F</b> 300 tests (liquid) <b>HI93701-01</b> 100 tests (powder) <b>HI93701-03</b> 300 tests (powder)
Chlorine, Total	0.00 to 5.00 mg/L (as Cl <sub>2</sub> )	0.01 mg/L	±0.03 mg/L ±3% of reading at 25 °C	525 nm	Adaptation of the EPA DPD Method 330.5	<b>HI93701-T</b> 300 tests (liquid) <b>HI93711-01</b> 100 total tests (powder) <b>HI93711-03</b> 300 total tests (powder)
Copper High Range	0.00 to 5.00 mg/L (as Cu <sup>2+</sup> )	0.01 mg/L	±0.02 mg/L ±4% of reading at 25 °C	575 nm	Adaptation of the EPA Method	<b>HI93702-01</b> Reagents for 100 tests <b>HI93702-03</b> Reagents for 300 tests
Cyanuric Acid	0 to 80 mg/L (as CYA)	1 mg/L	±1 mg/L ±15% of reading at 25 °C	525 nm	Adaptation of the Turbidimetric Method	<b>HI93722-01</b> Reagents for 100 tests <b>HI93722-03</b> Reagents for 300 tests
Hardness, Calcium	0.00 to 2.70 mg/L (as CaCO <sub>3</sub> )	0.01 mg/L	±0.11 mg/L ±5% of reading at 25 °C	525 nm	Adaptation of the Standard Methods for the Examination of Water and Wastewater, 18th Edition, Calmagite Method	<b>HI93720-01</b> Reagents for 100 tests <b>HI93720-03</b> Reagents for 300 tests
Iron High Range	0.00 to 5.00 mg/L (as Fe)	0.01 mg/L	±0.04 mg/L ±2% of reading at 25 °C	525 nm	Adaptation of Standard Methods for the Examination of Water and Wastewater, 23rd Edition, 3500-Fe B, Phenanthroline Method	<b>HI93721-01</b> Reagents for 100 tests <b>HI93721-03</b> Reagents for 300 tests
Nitrate	0.0 to 30.0 mg/L (as NO <sub>3</sub> <sup>-</sup> -N)	0.1 mg/L	±0.5 mg/L ±10% of reading at 25 °C	525 nm	Adaptation of the Cadmium Reduction Method	<b>HI93728-01</b> Reagents for 100 tests <b>HI93728-03</b> Reagents for 300 tests
Ozone	0.00 to 2.00 mg/L (as O <sub>3</sub> )	0.01 mg/L	±0.02 mg/L ±3% of reading at 25 °C	525 nm	Colorimetric DPD Method	<b>HI93757-01</b> Reagents for 100 tests <b>HI93757-03</b> Reagents for 300 tests <b>HI93703-52</b> Reagents for 100 tests (Optional)
pH	6.5 to 8.5 pH	0.1 pH	±0.1 pH at 25 °C	525 nm	Adaptation of the Phenol Red Method	<b>HI93710-01</b> Reagents for 100 pH tests <b>HI93710-03</b> Reagents for 300 pH tests
Phosphate Low Range	0.00 to 2.50 mg/L (as PO <sub>4</sub> <sup>3-</sup> )	0.01 mg/L	±0.04 mg/L ±4% of reading at 25 °C	610 nm	Adaptation of the Ascorbic Acid Method	<b>HI93713-01</b> Reagents for 100 tests <b>HI93713-03</b> Reagents for 300 tests

#### Ordering Information

**HI83326-01** (115V) and **HI83326-02** (230V) is supplied with sample cuvette (4 pcs.), sample cuvette cap (4 pcs.), cloth for wiping cuvettes, scissors, 100 mL graduated beaker, USB cable, 5 Vdc power adapter, instrument quality certificate, and instruction manual.

#### Standards

**HI83326-11** CAL Check Cuvette Kit for HI83326

HI83308

# Multiparameter Photometer

with Digital pH Electrode Input  
for Water Conditioning

The HI83308 benchtop photometer measures 15 different key water quality parameters using 23 different methods. This photometer features an innovative optical system that uses an LED, a narrow band interference filter, a focusing lens, and both a silicon photodetector for absorbance measurement and a reference detector to maintain a consistent light source to ensure accurate and repeatable photometric readings every time.

The HI83308 was developed to measure the most common parameters in water quality monitoring. One important parameter to test water quality is iron since it can affect color, odor, and turbidity and can also be the most troublesome factor for appliances and surfaces in contact with water. High levels of iron in water can result in clogged water pipes or heat exchangers. Also, ammonia detection in water treatment systems is particularly important for aquarium owners and fish farm operators since ammonia is highly soluble in water and extremely toxic to fish. One other important parameter in water quality monitoring is fluoride. Fluoride is best known for preventing tooth decay. While it does help prevent tooth decay, too little fluoride can be ineffective while too much can cause staining of teeth.

- **Advanced optical system**
  - Innovative optical design that utilizes a reference detector and focusing lens to eliminate errors from changes in the light source and from imperfections in the glass cuvette
- **Backlit 128 x 64 Pixel Graphic LCD Display**
  - Backlit graphic display allows for easy viewing in low light conditions
  - The 128 x 64 Pixel LCD allows for a simplified user interface with virtual keys and on-screen help to guide the user through use of the meter
- **Built-in Reaction Timer for Photometric Measurements**
  - The measurement is taken after the countdown timer expires.
  - Countdown timer ensures that all readings are taken at the appropriate reaction intervals regardless of user for better consistency in measurements



- **Absorbance mode**
  - Hanna's exclusive CAL Check™ cuvettes for validation of light source and detector
  - Allows for the user to plot concentration versus absorbance for a specific wavelength for use with user supplied chemistry or for teaching principles of photometry
- **Units of Measure**
  - Appropriate unit of measure along with chemical form is displayed along with reading
- **Result Conversion**
  - Automatically convert readings to other chemical forms with the touch of a button
- **Cuvette Cover**
  - Aids in preventing stray light from affecting measurements
- **Digital pH Electrode Input**
  - Measure pH and temperature with a single probe
  - Good Laboratory Practice (GLP) to track calibration information including date, time, buffers used, offset and slope for traceability
  - pH CAL Check™ alerts user to potential problems during the calibration process
  - Space saving having a pH meter and photometer built into one meter
- **Battery Status Indicator**
  - Indicates the amount of battery life left
- **Data Logging**
  - Up to 1000 photometric and pH readings can be stored by simply pressing the dedicated LOG button. Logged readings are just as easily recalled by pressing the RCL button
  - Sample ID and User ID information can be added to a logged reading using the alphanumeric keypad
- **Connectivity**
  - Logged readings can be quickly and easily transferred to a flash drive using the USB-A host port or to a computer using the micro USB-B port
  - Data is exported as a .CSV file for use with common spreadsheet programs
- **Rechargeable Battery**
  - Li-polymer rechargeable battery lasts for 500 measurements or 50 hours of pH measurement
- **Error Messages**
  - Photometric error messages
  - pH calibration messages include clean electrode, check buffer and check probe



HI83308-11

Parameter	Range	Resolution	Accuracy	Wavelength	Method	Reagent Code
Ammonia Low Range	0.00 to 3.00 mg/L (as NH <sub>3</sub> -N)	0.01 mg/L	±0.04 mg/L ±4% of reading at 25 °C	420 nm	Adaptation of the ASTM Manual of Water and Environmental Technology, D1426, Nessler Method	<b>HI93700-01</b> Reagents for 100 tests
						<b>HI93700-03</b> Reagents for 300 tests
Ammonia Medium Range	0.00 to 10.00 mg/L (as NH <sub>3</sub> -N)	0.01 mg/L	±0.05 mg/L ±5% of reading at 25 °C	420 nm	Adaptation of the ASTM Manual of Water and Environmental Technology, D1426, Nessler Method	<b>HI93715-01</b> Reagents for 100 tests
						<b>HI93715-03</b> Reagents for 300 tests
Ammonia High Range	0.0 to 100.0 mg/L (as NH <sub>3</sub> -N)	0.1 mg/L	±0.5 mg/L ±5% of reading at 25 °C	420 nm	Adaptation of the ASTM Manual of Water and Environmental Technology, D1426, Nessler Method	<b>HI93733-01</b> Reagents for 100 tests
						<b>HI93733-03</b> Reagents for 300 tests
Chlorine, Free	0.00 to 5.00 mg/L (as Cl <sub>2</sub> )	0.01 mg/L	±0.03 mg/L ±3% of reading at 25 °C	525 nm	Adaptation of the EPA DPD Method 330.5	<b>HI93701-F</b> Reagents for 300 tests (liquid)
						<b>HI93701-01</b> Reagents for 100 tests (powder)
						<b>HI93701-03</b> Reagents for 300 tests (powder)
Chlorine, Total	0.00 to 5.00 mg/L (as Cl <sub>2</sub> )	0.01 mg/L	±0.03 mg/L ±3% of reading at 25 °C	525 nm	Adaptation of the EPA DPD Method 330.5	<b>HI93701-T</b> Reagents for 300 tests (liquid)
						<b>HI93711-01</b> Reagents for 100 total tests (powder)
						<b>HI93711-03</b> Reagents for 300 total tests (powder)
Copper Low Range	0.000 to 1.500mg/L (as Cu <sup>2+</sup> )	0.001mg/L	±0.010mg/L ±5% of reading at 25 °C	575 nm	Adaptation of the EPA Method	<b>HI95747-01</b> Reagents for 100 tests
						<b>HI95747-03</b> Reagents for 300 tests
Copper High Range	0.00 to 5.00 mg/L (as Cu <sup>2+</sup> )	0.01 mg/L	±0.02 mg/L ±4% of reading at 25 °C	575 nm	Adaptation of the EPA Method	<b>HI93702-01</b> Reagents for 100 tests
						<b>HI93702-03</b> Reagents for 300 tests
Fluoride Low Range	0.00 to 2.00 mg/L (as F <sup>-</sup> )	0.01 mg/L	±0.03 mg/L ±3% of reading at 25 °C	575 nm	Adaptation of the Standard Methods for the Examination of Water and Wastewater, 18th Edition, SPADNS Method	<b>HI93729-01</b> Reagents for 100 tests <b>HI93729-03</b> Reagents for 300 tests
Iron Low Range	0.000 to 1.600 mg/L (as Fe)	0.001 mg/L	±0.010 mg/L ±8% of reading at 25 °C	575 nm	Adaptation of the TPTZ Method	<b>HI93746-01</b> Reagents for 50 tests
						<b>HI93746-03</b> Reagents for 150 tests
Iron High Range	0.00 to 5.00 mg/L (as Fe)	0.01 mg/L	±0.04 mg/L ±2% of reading at 25 °C	525 nm	Adaptation of Standard Methods for the Examination of Water and Wastewater, 23rd Edition, 3500-Fe B, Phenanthroline Method	<b>HI93721-01</b> Reagents for 100 tests
						<b>HI93721-03</b> Reagents for 300 tests
Manganese Low Range	0 to 300 µg/L (as Mn)	1 µg/L	±10 µg/L ±3% of reading at 25 °C	575 nm	Adaptation of the PAN Method	<b>HI93748-01</b> Reagents for 50 tests
						<b>HI93748-03</b> Reagents for 150 tests
Manganese High Range	0.0 to 20.0 mg/L (as Mn)	0.1 mg/L	±0.2 mg/L ±3% of reading at 25 °C	525 nm	Adaptation of the Standard Methods for the Examination of Water and Wastewater, 18th Edition, Periodate Method	<b>HI93709-01</b> Reagents for 100 tests
						<b>HI93709-03</b> Reagents for 300 tests
Molybdenum	0.0 to 40.0 mg/L (as Mo <sup>6+</sup> )	0.1 mg/L	±0.3 mg/L ±5% of reading at 25 °C	420 nm	Adaptation of the Mercaptoacetic Acid Method	<b>HI93730-01</b> Reagents for 100 tests <b>HI93730-03</b> Reagents for 300 tests
Nickel Low Range	0.000 to 1.000 mg/L (as Ni)	0.001 mg/L	±0.010 mg/L ±7% of reading at 25 °C	575 nm	Adaptation of the PAN Method	<b>HI93740-01</b> Reagents for 50 tests
						<b>HI93740-03</b> Reagents for 150 tests
Nickel High Range	0.00 to 7.00 g/L (as Ni)	0.01 g/L	±0.07 g/L ±4% of reading at 25 °C	575 nm	Adaptation of the Photometric Method	<b>HI93726-01</b> Reagents for 100 tests
						<b>HI93726-03</b> Reagents for 300 tests
Nitrate	0.0 to 30.0 mg/L (as NO <sub>3</sub> <sup>-</sup> -N)	0.1 mg/L	±0.5 mg/L ±10% of reading at 25 °C	525 nm	Adaptation of the Cadmium Reduction Method	<b>HI93728-01</b> Reagents for 100 tests
						<b>HI93728-03</b> Reagents for 300 tests
Oxygen, Dissolved	0.0 to 10.0 mg/L (as O <sub>2</sub> )	0.1 mg/L	±0.4 mg/L ±3% of reading at 25 °C	420 nm	Adaptation of the Standard Methods for the Examination of Water and Wastewater, 18th Edition, Azide Modified Winkler Method	<b>HI93732-01</b> Reagents for 100 tests
						<b>HI93732-03</b> Reagents for 300 tests
pH	6.5 to 8.5 pH	0.1 pH	±0.1 pH at 25 °C	525 nm	Adaptation of the Phenol Red Method	<b>HI93710-01</b> Reagents for 100 pH tests
						<b>HI93710-03</b> Reagents for 300 pH tests
Phosphate Low Range	0.00 to 2.50 mg/L (as PO <sub>4</sub> <sup>3-</sup> )	0.01 mg/L	±0.04 mg/L ±4% of reading at 25 °C	610 nm	Adaptation of the Ascorbic Acid Method	<b>HI93713-01</b> Reagents for 100 tests
						<b>HI93713-03</b> Reagents for 300 tests
Phosphate High Range	0.0 to 30.0 mg/L (as PO <sub>4</sub> <sup>3-</sup> )	0.1 mg/L	±1.0 mg/L ±4% of reading at 25 °C	525 nm	Adaptation of the Standard Methods for the Examination of Water and Wastewater, 18th Edition, Amino Acid Method	<b>HI93717-01</b> Reagents for 100 tests
						<b>HI93717-03</b> Reagents for 300 tests
Silica Low Range	0.00 to 2.00 mg/L (as SiO <sub>2</sub> )	0.01 mg/L	±0.03 mg/L ±3% of reading at 25 °C	610 nm	Adaptation of the ASTM Manual of Water and Environmental Technology, D859, Heteropoly Molybdenum Blue Method	<b>HI93705-01</b> Reagents for 100 tests
						<b>HI93705-03</b> Reagents for 300 tests
Silver	0.000 to 1.000 mg/L (as Ag)	0.001 mg/L	±0.020 mg/L ±5% of reading at 25 °C	575 nm	Adaptation of the PAN Method	<b>HI93737-01</b> Reagents for 50 tests
						<b>HI93737-03</b> Reagents for 150 tests
Zinc	0.00 to 3.00 mg/L (as Zn)	0.01 mg/L	±0.03 mg/L ±3% of reading at 25 °C	575 nm	Adaptation of the Standard Methods for the Examination of Water and Wastewater, 18th Edition, Zincon Method	<b>HI93731-01</b> Reagents for 100 tests
						<b>HI93731-03</b> Reagents for 300 tests
<b>Ordering Information</b>	<b>HI83308-01</b> (115V) and <b>HI83308-02</b> (230V) is supplied with sample cuvette (4 pcs.), sample cuvette cap (4 pcs.), cloth for wiping cuvettes, scissors, USB cable, 5 Vdc power adapter, 60 mL glass bottle, instrument quality certificate, and instruction manual.					
<b>Standards</b>	<b>HI83308-11</b> CAL Check Cuvette Kit for HI83308					

## Advanced Waterproof Portable Photometers

These portable photometers are designed with an innovative optical system that offers superior performance in accuracy, repeatability, and the amount of time that it takes to do a measurement.

These waterproof meters are extremely user friendly with a tutorial mode that walks the user graphically, step by step, in performing a measurement. The use of a backlit dot matrix LED allows the use of virtual keys making operation of the meter very intuitive.



## General Features

### Waterproof casing

The casing offers IP67 waterproof protection and floats.

### Advanced LED optical system

LEDs have a much higher luminous efficiency, providing more light while using less power. They also produce little heat, which could otherwise affect electronic stability.

### CAL Check™ functionality

Hanna's exclusive CAL Check feature allows for performance verification and calibration of the meter using NIST traceable standards. Our CAL Check standard vials are developed to simulate a specific absorbance value at each wavelength to verify the accuracy of subsequent readings. The CAL Check screen guides the user step-by-step through the validation process and user calibration.

### Multiple measurement methods

Users can select the use of powder reagents supplied in packets or the use of liquid reagents supplied in a dropper bottle.

### Built-in reaction timer

Waiting the proper reaction time is of key importance when performing colorimetric measurements. The countdown timer displays the time remaining until a measurement will be taken, ensuring consistent results between sample measurements and users.

### Large cuvette size

The sample cell of these photometers fits a round, glass cuvette with a 25 mm path length. The relatively long path length of the sample cuvette allows the light to pass through more of the sample solution, ensuring accurate measurements even in low absorbance samples. The cuvette holder features ridges to protect scratching of the optical path by the cuvette.

### Intuitive dot matrix display

These photometers are designed with a backlit, graphic LCD. With virtual keys, a battery status indicator, and error messages. Users will find the interface intuitive and easy to read.

### GLP data

Good Laboratory Practice (GLP) shows the date and time of the last user calibration.



### Auto logging

Log and recall the last 50 measurements.

### Dedicated help

A dedicated help key provides information relating to the current meter operation, and can be used at any stage in the setup or measurement process to show contextual help.

### On-screen tutorial mode with animations

The built in Tutorial mode guides users step-by-step through the measurement process.

### Error messages

Messages appear on the display alerting to problems such as out of range, light low, light high, ambient temperature out of limits, and battery low.

### Auto-off protection

These meters use three AA batteries that allow for about 800 measurements to be taken. The auto-off feature automatically shuts off the meter after 15 minutes of inactivity in order conserve battery life.

### Battery status indicator

Indicates the amount of battery life left.

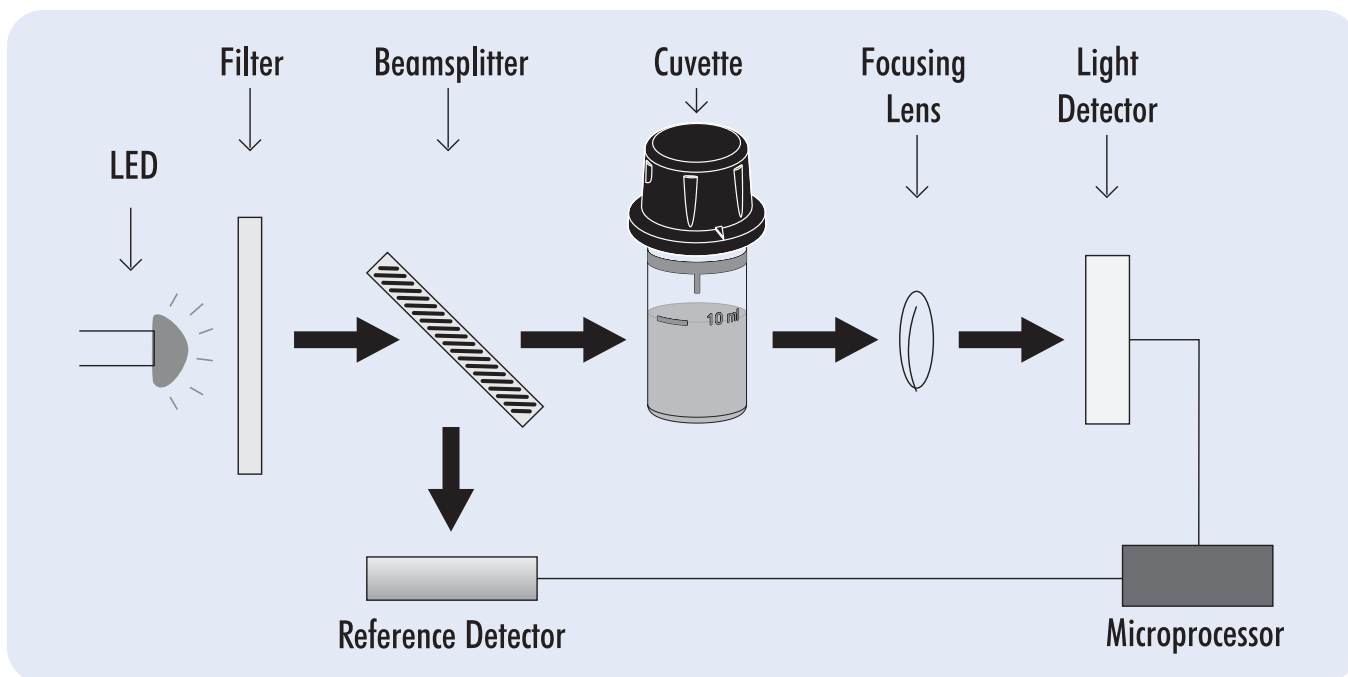

## Advanced Optical System

- LED that generates little heat
- 8 nm narrow band interference filter that is accurate to  $\pm 1$  nm and offers 25% increase in light efficiency.
- Reference detector that modulates the voltage to LED for consistent light output.
- A concave focusing lens that reduces errors from imperfections in the cuvette

## High Efficiency Light Source

LED light sources offer superior performance compared to tungsten lamps. LEDs have a much higher luminous efficiency, providing more light while using less power. They also produce little heat, which could otherwise affect electronic stability. LEDs are available in a wide array of wavelengths, whereas tungsten lamps have poor blue/violet light output.

## High Quality Filters

Improved optical filters ensure greater wavelength accuracy and allow a brighter, stronger signal to be received. The end result is higher measurement stability and less wavelength error.

## Stable Light Source

The internal reference system of these photometers compensates for any drifts due to power fluctuations or ambient temperature changes. With a stable source of light the readings are fast and reliable between your blank (zero) measurement and sample measurement.

## Greater Light Yield

A focusing lens collects all of the light that exits the cuvette, reducing errors from imperfections and scratches that may be present in the glass. The use of the convex lens reduces the need for indexing cuvettes.





**Method and Parameter**

Chosen parameter and method used is displayed along with the reading.

**Backlit LCD**

The 128 x 64 Pixel LCD allows for a simplified user interface with virtual keys and on-screen help to guide the user through use of the meter.

**Positive locking system**

The Hanna positive-locking system ensures cuvettes are placed into the holder in the same position every time.



**On-Screen Features**

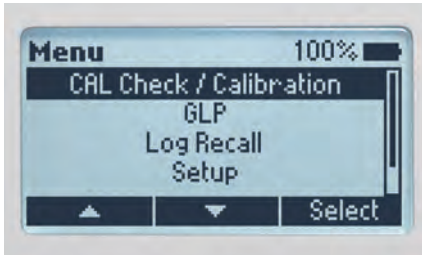

Advanced features such as CAL Check™ to verify performance, GLP for last calibration date, setup and ability to see all accessories used with the meter.



Setup options for meter personalization include date and time format, language, and enabling the tutorial mode.

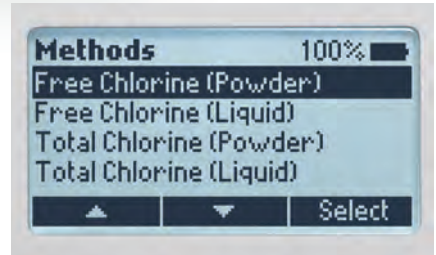

Choice of powder or economical easy to use liquid reagents.

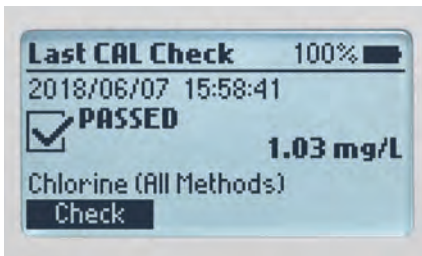

Backlit dot matrix LCD that offers an exceptionally intuitive user interface that is easy to read and understand.



Tutorial mode for step-by-step instructions to guide a first time user to performing a measurement correctly.

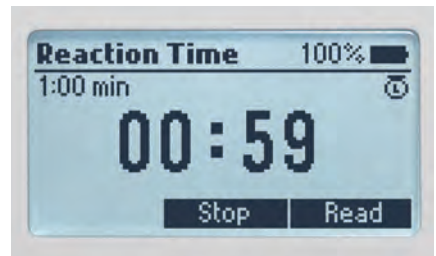

Displays time remaining before a measurement is taken. Ensures that all readings are taken at the appropriate intervals for the test being performed.



Virtual keys



Menu available at the touch of a button



Contextual HELP button

A dedicated help key provides informational help relating to the current meter operation, and can be used at any stage in the setup or measurement process.

Accessories

<b>HI93703-50</b>	Cuvette cleaning solution, 250 mL	<b>HI7101412</b>	Carrying case for HI977 series with two CAL Check standards
<b>HI731318</b>	Cuvette cleaning cloth (4)	<b>HI7101413</b>	Carrying case for HI977 series with three CAL Check standards
<b>HI731331</b>	Measuring cuvettes (4)	<b>HI7101415</b>	Carrying case for HI977 series with five CAL Check standards
<b>HI731336N</b>	Cuvette caps (4)	<b>HI7101417</b>	Carrying case for HI977 series with seven CAL Check standards
<b>HI731360</b>	Glass cuvette with cap (2 pcs.) for HI977 series	<b>HI7101418</b>	Carrying case for HI97105
<b>HI70436M</b>	Deionized water (230 mL)		



HI97712

## Aluminum Portable Photometer

- **Advanced LED optical system**
  - Innovative optical design that utilizes a reference detector and focusing lens to eliminate errors from changes in the light source and from imperfections in the glass cuvette.
  - LEDs have a much higher luminous efficiency, providing more light while using less power. They also produce little heat, which could otherwise affect electronic stability.
- **CAL Check™**
  - Validate instrument performance at any time using CAL Check cuvettes made with NIST traceable standards. The CAL Check screen guides the user step-by-step through the validation process and user calibration.
- **On-screen tutorial mode with animations**
  - Guides users step-by-step through the measurement process
- **Waterproof and floating IP67 case**
- **Unit of measure is displayed along with reading**
- **Built-in timer**
  - Built-in reaction timer that ensures consistency between tests.
- **Error messages on display**
  - Alerts to problems including no cap, high zero, and standard too low
- **GLP data**
  - Displays the last calibration date.
- **Auto logging**
- **Battery status indicator**
- **Auto-shut off**

Specifications	HI97712 Aluminum	
Measurement	Range	0.00 to 1.00 mg/L (ppm) (as Al <sup>3+</sup> )
	Resolution	0.01 mg/L (ppm)
	Accuracy @25°C (77°F)	±0.04 mg/L ±4% of reading
	Method	adaptation of the aluminon method
Measurement System	Light Source	light emitting diode
	Bandpass filter	525 nm
	Bandpass filter bandwidth	8 nm
	Bandpass filter wavelength accuracy	±1.0 nm
	Light Detector	silicon photocell
	Cuvette type	round 24.6 mm diameter (22 mm inside)
Additional Specifications	Auto logging	50 readings
	Display	128 x 64 pixel B/W LCD with backlight
	Auto-off	after 15 minutes of inactivity (30 minutes before a READ measurement)
	Battery type / Life	alkaline 1.5 V AA (3) / > 800 measurements (without backlight)
	Environment	0 to 50°C (32 to 122°F); 0 to 100% RH, non-serviceable
	Dimensions	142.5 x 102.5 x 50.5 mm (5.6 x 4.0 x 2.0")
	Weight	380 g (13.4 oz.)

**HI97712** is supplied with sample cuvettes (2), sample caps (2), plastic stoppers (2), 1.5V AA batteries (3), instrument quality certificate, and instruction manual.

CAL Check standards and testing reagents sold separately

**HI97712C** includes photometer, CAL Check standards, sample cuvettes (2), sample caps (2), plastic stoppers (2), 1.5V AA batteries (3), cuvette wiping cloth, scissors, CAL Check standard certificate, instrument quality certificate, instruction manual, and HI7101412 rigid carrying case.

Reagents sold separately

### Ordering Information

### Reagents and Standards

HI97712	<b>HI97712-11</b> CAL Check standard cuvettes for aluminum
	<b>HI93712-01</b> aluminum reagents for 100 tests
	<b>HI93712-03</b> aluminum reagents for 300 tests

See page 10.114 for standard reagents; see page 10.115 for CAL Check kits; see page 10.52 for general accessories

HI97700 · HI97715

# Ammonia LR and MR Portable Photometers

- **Advanced LED optical system**
  - Innovative optical design that utilizes a reference detector and focusing lens to eliminate errors from changes in the light source and from imperfections in the glass cuvette.
  - LEDs have a much higher luminous efficiency, providing more light while using less power. They also produce little heat, which could otherwise affect electronic stability.
- **CAL Check™**
  - Validate instrument performance at any time using CAL Check cuvettes made with NIST traceable standards. The CAL Check screen guides the user step-by-step through the validation process and user calibration.
- **On-screen tutorial mode with animations**
  - Guides users step-by-step through the measurement process
- **Waterproof and floating IP67 case**
- **Unit of measure is displayed along with reading**
- **Built-in timer**
  - Built-in reaction timer that ensures consistency between tests.
- **Error messages on display**
  - Alerts to problems including no cap, high zero, and standard too low
- **GLP data**
  - Displays the last calibration date.
- **Auto logging**
- **Battery status indicator**
- **Auto-shut off**



Specifications	HI97700 Ammonia LR	HI97715 Ammonia MR	
Measurement	Range	0.00 to 3.00 mg/L (ppm) (as NH <sub>3</sub> -N)	0.00 to 10.00 mg/L (ppm) (as NH <sub>3</sub> -N)
	Resolution	0.01 mg/L	0.01 mg/L
	Accuracy @25°C (77°F)	±0.04 mg/L ±4% of reading	±0.05 mg/L ±5% of reading
Measurement System	Method	adaptation of the ASTM Manual of Water and Environmental Technology, D1426 Nessler method	
	Light Source	light emitting diode	
	Bandpass filter	420 nm	
	Bandpass filter bandwidth	8 nm	
	Bandpass filter wavelength accuracy	±1.0 nm	
	Light Detector	silicon photocell	
Additional Specifications	Cuvette type	round 24.6 mm diameter (22 mm inside)	
	Auto logging	50 readings	
	Display	128 x 64 pixel B/W LCD with backlight	
	Auto-off	after 15 minutes of inactivity (30 minutes before a READ measurement)	
	Battery type / Life	alkaline 1.5 V AA (3) / > 800 measurements (without backlight)	
	Environment	0 to 50°C (32 to 122°F); 0 to 100% RH, non-serviceable	
	Dimensions	142.5 x 102.5 x 50.5 mm (5.6 x 4.0 x 2.0")	
Weight	380 g (13.4 oz.)		
Ordering Information	<b>HI97700</b> and <b>HI97715</b> are supplied with sample cuvettes (2), sample caps (2), plastic stoppers (2), 1.5V AA batteries (3), instrument quality certificate, and instruction manual. CAL Check standards and testing reagents sold separately		
	<b>HI97700C</b> and <b>HI97715C</b> include photometer, CAL Check standards, sample cuvettes (2), sample caps (2), plastic stoppers (2), 1.5V AA batteries (3), cuvette wiping cloth, scissors, CAL Check standard certificate, instrument quality certificate, instruction manual, and HI7101412 rigid carrying case. Reagents sold separately		
Reagents and Standards	HI97700	<b>HI97700-11</b> CAL Check standard cuvettes for ammonia LR	
		<b>HI93700-01</b> ammonia LR reagent for 100 tests	
		<b>HI93700-03</b> ammonia LR reagent for 300 tests	
	HI97715	<b>HI97715-11</b> CAL Check standard cuvettes for ammonia MR	
		<b>HI93715-01</b> ammonia MR reagent for 100 tests	
		<b>HI93715-03</b> ammonia MR reagent for 300 tests	

HI97733

# Ammonia HR Portable Photometer



- **Advanced LED optical system**
  - Innovative optical design that utilizes a reference detector and focusing lens to eliminate errors from changes in the light source and from imperfections in the glass cuvette.
  - LEDs have a much higher luminous efficiency, providing more light while using less power. They also produce little heat, which could otherwise affect electronic stability.
- **CAL Check™**
  - Validate instrument performance at any time using CAL Check cuvettes made with NIST traceable standards. The CAL Check screen guides the user step-by-step through the validation process and user calibration.
- **On-screen tutorial mode with animations**
  - Guides users step-by-step through the measurement process
- **Waterproof and floating IP67 case**
- **Unit of measure is displayed along with reading**
- **Built-in timer**
  - Built-in reaction timer that ensures consistency between tests.
- **Error messages on display**
  - Alerts to problems including no cap, high zero, and standard too low
- **GLP data**
  - Displays the last calibration date.
- **Auto logging**
- **Battery status indicator**
- **Auto-shut off**

Specifications		HI97733 Ammonia HR
Measurement	Range	0.0 to 100.0 mg/L (ppm) (as NH <sub>4</sub> <sup>+</sup> )
	Resolution	0.01 mg/L
	Accuracy @25°C (77°F)	±0.5 mg/L ±5% of reading
	Method	adaptation of the ASTM Manual of Water and Environmental Technology, D1426 Nessler method
Measurement System	Light Source	light emitting diode
	Bandpass filter	420 nm
	Bandpass filter bandwidth	8 nm
	Bandpass filter wavelength accuracy	±1.0 nm
	Light Detector	silicon photocell
	Cuvette type	round 24.6 mm diameter (22 mm inside)
Additional Specifications	Auto logging	50 readings
	Display	128 x 64 pixel B/W LCD with backlight
	Auto-off	after 15 minutes of inactivity (30 minutes before a READ measurement)
	Battery type / Life	alkaline 1.5 V AA (3) / > 800 measurements (without backlight)
	Environment	0 to 50°C (32 to 122°F); 0 to 100% RH, non-serviceable
	Dimensions	142.5 x 102.5 x 50.5 mm (5.6 x 4.0 x 2.0")
	Weight	380 g (13.4 oz.)

**HI97733** is supplied with sample cuvettes (2), sample caps (2), plastic stoppers (2), 1.5V AA batteries (3), instrument quality certificate, and instruction manual.

CAL Check standards and testing reagents sold separately

**HI97733C** includes photometer, CAL Check standards, sample cuvettes (2), sample caps (2), plastic stoppers (2), 1.5V AA batteries (3), cuvette wiping cloth, scissors, CAL Check standard certificate, instrument quality certificate, instruction manual, and HI7101412 rigid carrying case.

Reagents sold separately

## Ordering Information

Reagents and Standards	HI97733	
		<b>HI97733-11</b> CAL Check standard cuvettes for Ammonia HR
		<b>HI93733-01</b> ammonia HR reagent for 100 tests
		<b>HI93733-03</b> ammonia HR reagent for 300 tests

## Significance of Use

Present naturally in surface and wastewaters, ammonia mainly results from the deamination of organic nitrogen-containing compounds and hydrolysis of urea. Ammonia may also be present from water treatment processes that utilize chloramines for disinfection, where ammonia is added to the water to react with chlorine. Ammonia is less likely to appear in groundwater due to adsorption by soil particles.

HI97769

# Anionic Surfactants, Portable Photometer

- **Advanced LED optical system**
  - Innovative optical design that utilizes a reference detector and focusing lens to eliminate errors from changes in the light source and from imperfections in the glass cuvette.
  - LEDs have a much higher luminous efficiency, providing more light while using less power. They also produce little heat, which could otherwise affect electronic stability.
- **CAL Check™**
  - Validate instrument performance at any time using CAL Check cuvettes made with NIST traceable standards. The CAL Check screen guides the user step-by-step through the validation process and user calibration.
- **On-screen tutorial mode with animations**
  - Guides users step-by-step through the measurement process
- **Waterproof and floating IP67 case**
- **Unit of measure is displayed along with reading**
- **Built-in timer**
  - Built-in reaction timer that ensures consistency between tests.
- **Error messages on display**
  - Alerts to problems including no cap, high zero, and standard too low
- **GLP data**
  - Displays the last calibration date.
- **Auto logging**
- **Battery status indicator**
- **Auto-shut off**



## Specifications

## HI97769 Anionic Surfactants

Measurement	Range	0.00 to 3.50 mg/L (as SDBS)
	Resolution	0.01 mg/L
	Accuracy @25°C (77°F)	±0.04 mg/L ±3% of reading
	Method	adaptation of the US EPA Method 425.1 and Standard Methods for the Examination of Water & Wastewater, 20th Edition, 5540C, Anionic Surfactants as MBAS
Measurement System	Light Source	light emitting diode
	Bandpass filter	610 nm
	Bandpass filter bandwidth	8 nm
	Bandpass filter wavelength accuracy	±1.0 nm
Additional Specifications	Light Detector	silicon photocell
	Cuvette type	round 24.6 mm diameter (22 mm inside)
	Auto logging	50 readings
	Display	128 x 64 pixel B/W LCD with backlight
Additional Specifications	Auto-off	after 15 minutes of inactivity (30 minutes before a READ measurement)
	Battery type / Life	alkaline 1.5 V AA (3) / > 800 measurements (without backlight)
	Environment	0 to 50°C (32 to 122°F); 0 to 100% RH, non-serviceable
	Dimensions	142.5 x 102.5 x 50.5 mm (5.6 x 4.0 x 2.0")
	Weight	380 g (13.4 oz.)

**HI97769** is supplied with sample cuvettes (2), sample caps (2), plastic stoppers (2), 1.5V AA batteries (3), instrument quality certificate, and instruction manual.

CAL Check standards and testing reagents sold separately

## Ordering Information

**HI97769C** includes photometer, CAL Check standards, sample cuvettes (2), sample caps (2), plastic stoppers (2), 1.5V AA batteries (3), scissors, cuvette wiping cloth, CAL Check standard certificate, instrument quality certificate, instruction manual, and rigid carrying case.

Reagents sold separately

Reagents and Standards	HI97769	<b>HI97769-11</b> CAL Check standard cuvettes for anionic surfactants
		<b>HI95769-01</b> anionic surfactants reagents for 40 tests

HI97716

# Bromine Portable Photometer



- **Advanced LED optical system**
  - Innovative optical design that utilizes a reference detector and focusing lens to eliminate errors from changes in the light source and from imperfections in the glass cuvette.
  - LEDs have a much higher luminous efficiency, providing more light while using less power. They also produce little heat, which could otherwise affect electronic stability.
- **CAL Check™**
  - Validate instrument performance at any time using CAL Check cuvettes made with NIST traceable standards. The CAL Check screen guides the user step-by-step through the validation process and user calibration.
- **On-screen tutorial mode with animations**
  - Guides users step-by-step through the measurement process
- **Waterproof and floating IP67 case**
- **Unit of measure is displayed along with reading**
- **Built-in timer**
  - Built-in reaction timer that ensures consistency between tests.
- **Error messages on display**
  - Alerts to problems including no cap, high zero, and standard too low
- **GLP data**
  - Displays the last calibration date.
- **Auto logging**
- **Battery status indicator**
- **Auto-shut off**

## Significance of Use

In some areas around the world, bromine is replacing other more common disinfectants, such as chlorine. Due to its stability at higher temperatures and higher pH levels, bromine is most often used in sanitization of pools and spas, and cooling towers.

Specifications	HI97716 Bromine	
Measurement	Range	0.00 to 10.00 mg/L (ppm) (as Br <sub>2</sub> )
	Resolution	0.01 mg/L
	Accuracy @25°C (77°F)	±0.08 mg/L ± 3% of reading
	Method	adaptation of the Standard Methods for the Examination of Water and Wastewater, 20th edition, DPD method
Measurement System	Light Source	light emitting diode
	Bandpass filter	525 nm
	Bandpass filter bandwidth	8 nm
	Bandpass filter wavelength accuracy	±1.0 nm
	Light Detector	silicon photocell
Additional Specifications	Cuvette type	round 24.6 mm diameter (22 mm inside)
	Auto logging	50 readings
	Display	128 x 64 pixel B/W LCD with backlight
	Auto-off	after 15 minutes of inactivity (30 minutes before a READ measurement)
	Battery type / Life	alkaline 1.5 V AA (3) / > 800 measurements (without backlight)
	Environment	0 to 50°C (32 to 122°F); 0 to 100% RH, non-serviceable
	Dimensions	142.5 x 102.5 x 50.5 mm (5.6 x 4.0 x 2.0")
Weight	380 g (13.4 oz.)	

**HI97716** is supplied with sample cuvettes (2), sample caps (2), plastic stoppers (2), 1.5V AA batteries (3), instrument quality certificate, and instruction manual.

CAL Check standards and testing reagents sold separately

### Ordering Information

**HI97716C** includes photometer, CAL Check standards, sample cuvettes (2), sample caps (2), plastic stoppers (2), 1.5V AA batteries (3), cuvette wiping cloth, scissors, CAL Check standard certificate, instrument quality certificate, instruction manual, and HI7101412 rigid carrying case.

Reagents sold separately

Reagents and Standards	HI97716	
		<b>HI97716-11</b> CAL Check standard cuvettes for bromine
		<b>HI93716-01</b> bromine reagents for 100 tests
		<b>HI93716-03</b> bromine reagents for 300 tests

HI97753

# Chloride Portable Photometer

- **Advanced LED optical system**
  - Innovative optical design that utilizes a reference detector and focusing lens to eliminate errors from changes in the light source and from imperfections in the glass cuvette.
  - LEDs have a much higher luminous efficiency, providing more light while using less power. They also produce little heat, which could otherwise affect electronic stability.
- **CAL Check™**
  - Validate instrument performance at any time using CAL Check cuvettes made with NIST traceable standards. The CAL Check screen guides the user step-by-step through the validation process and user calibration.
- **On-screen tutorial mode with animations**
  - Guides users step-by-step through the measurement process
- **Waterproof and floating IP67 case**
- **Unit of measure is displayed along with reading**
- **Built-in timer**
  - Built-in reaction timer that ensures consistency between tests.
- **Error messages on display**
  - Alerts to problems including no cap, high zero, and standard too low
- **GLP data**
  - Displays the last calibration date.
- **Auto logging**
- **Battery status indicator**
- **Auto-shut off**

## Significance of Use

As one of the major inorganic anions in water and wastewater, chloride is often measured in a variety of industries. Due to its corrosive nature, chloride levels are monitored in boiler systems and cooling towers to prevent metal parts from being damaged. Not known to be toxic to humans, chloride is monitored in drinking water for aesthetic purposes due to its negative affect on taste. However, chloride can be toxic to plant life. Chloride may be monitored in agricultural applications in certain areas of the world where salinity levels are known to be naturally high.



Specifications		HI97753 Chloride
Measurement	Range	0.0 to 20.0 mg/L (ppm) ( as Cl <sup>-</sup> )
	Resolution	0.1 mg/L
	Accuracy @25°C (77°F)	±0.5 mg/L ±6% of reading
Measurement System	Method	adaptation of the mercury (II) thiocyanate method
	Light Source	light emitting diode
	Bandpass filter	466 nm
	Bandpass filter bandwidth	8 nm
	Bandpass filter wavelength accuracy	±1.0 nm
	Light Detector	silicon photocell
Additional Specifications	Cuvette type	round 24.6 mm diameter (22 mm inside)
	Auto logging	50 readings
	Display	128 x 64 pixel B/W LCD with backlight
	Auto-off	after 15 minutes of inactivity (30 minutes before a READ measurement)
	Battery type / Life	alkaline 1.5 V AA (3) / > 800 measurements (without backlight)
	Environment	0 to 50°C (32 to 122°F); 0 to 100% RH, non-serviceable
	Dimensions	142.5 x 102.5 x 50.5 mm (5.6 x 4.0 x 2.0")
Weight	380 g (13.4 oz.)	

**HI97753** is supplied with sample cuvettes (2), sample caps (2), plastic stoppers (2), 1.5V AA batteries (3), instrument quality certificate, and instruction manual.

CAL Check standards and testing reagents sold separately

### Ordering Information

**HI97753C** includes photometer, CAL Check standards, sample cuvettes (2), sample caps (2), plastic stoppers (2), 1.5V AA batteries (3), cuvette wiping cloth, CAL Check standard certificate, instrument quality certificate, instruction manual, and HI7101412 rigid carrying case.

Reagents sold separately

Reagents and Standards	HI97753
	<b>HI97753-11</b> CAL Check standard cuvettes for chloride
	<b>HI93753-01</b> chloride reagents for 100 tests
	<b>HI93753-03</b> chloride reagents for 300 tests



HI97738

# Chlorine Dioxide Portable Photometer



- **Advanced LED optical system**
  - Innovative optical design that utilizes a reference detector and focusing lens to eliminate errors from changes in the light source and from imperfections in the glass cuvette.
  - LEDs have a much higher luminous efficiency, providing more light while using less power. They also produce little heat, which could otherwise affect electronic stability.
- **CAL Check™**
  - Validate instrument performance at any time using CAL Check cuvettes made with NIST traceable standards. The CAL Check screen guides the user step-by-step through the validation process and user calibration.
- **On-screen tutorial mode with animations**
  - Guides users step-by-step through the measurement process
- **Waterproof and floating IP67 case**
- **Unit of measure is displayed along with reading**
- **Built-in timer**
  - Built-in reaction timer that ensures consistency between tests.
- **Error messages on display**
  - Alerts to problems including no cap, high zero, and standard too low
- **GLP data**
  - Displays the last calibration date.
- **Auto logging**
- **Battery status indicator**
- **Auto-shut off**

## Specifications

### HI97738 Chlorine Dioxide

Measurement	Range	0.00 to 2.00 mg/L (ppm) (as ClO <sub>2</sub> )
	Resolution	0.01 mg/L
	Accuracy @25°C (77°F)	±0.10 mg/L ±5% of reading
	Method	adaptation of chlorophenol red method
Measurement System	Light Source	light emitting diode
	Bandpass filter	575 nm
	Bandpass filter bandwidth	8 nm
	Bandpass filter wavelength accuracy	±1.0 nm
	Light Detector	silicon photocell
	Cuvette type	round 24.6 mm diameter (22 mm inside)
Additional Specifications	Auto logging	50 readings
	Display	128 x 64 pixel B/W LCD with backlight
	Auto-off	after 15 minutes of inactivity (30 minutes before a READ measurement)
	Battery type / Life	alkaline 1.5 V AA (3) / > 800 measurements (without backlight)
	Environment	0 to 50°C (32 to 122°F); 0 to 100% RH, non-serviceable
	Dimensions	142.5 x 102.5 x 50.5 mm (5.6 x 4.0 x 2.0")
	Weight	380 g (13.4 oz.)

**HI97738** is supplied with sample cuvettes (2), sample caps (2), plastic stoppers (2), 1.5V AA batteries (3), instrument quality certificate, and instruction manual.

CAL Check standards and testing reagents sold separately

**HI97738C** includes photometer, CAL Check standards, sample cuvettes (2), sample caps (2), plastic stoppers (2), 1.5V AA batteries (3), scissors, cuvette wiping cloth, CAL Check standard certificate, instrument quality certificate, instruction manual, and rigid carrying case.

Reagents sold separately

## Ordering Information

## Reagents and Standards

HI97738	<b>HI97738-11</b> CAL Check standard cuvettes for chlorine dioxide
	<b>HI93738-01</b> chlorine dioxide reagents for 100 tests
	<b>HI93738-03</b> chlorine dioxide reagents for 300 tests

## Significance of Use

Used primarily as a disinfectant in drinking water and in various industrial processes, chlorine dioxide is a highly effective, environmentally friendly microbicide. Chlorine dioxide is safe, potent, and does not produce trihalomethanes, the disinfection byproduct characteristic of chlorine use.

HI97779

# Chlorine Dioxide (Rapid) Portable Photometer

- **Advanced LED optical system**
  - Innovative optical design that utilizes a reference detector and focusing lens to eliminate errors from changes in the light source and from imperfections in the glass cuvette.
  - LEDs have a much higher luminous efficiency, providing more light while using less power. They also produce little heat, which could otherwise affect electronic stability.
- **CAL Check™**
  - Validate instrument performance at any time using CAL Check cuvettes made with NIST traceable standards. The CAL Check screen guides the user step-by-step through the validation process and user calibration.
- **On-screen tutorial mode with animations**
  - Guides users step-by-step through the measurement process
- **Waterproof and floating IP67 case**
- **Unit of measure is displayed along with reading**
- **Built-in timer**
  - Built-in reaction timer that ensures consistency between tests.
- **Error messages on display**
  - Alerts to problems including no cap, high zero, and standard too low
- **GLP data**
  - Displays the last calibration date.
- **Auto logging**
- **Battery status indicator**
- **Auto-shut off**



Specifications	HI97779 Chlorine Dioxide (Rapid)	
Measurement	Range	0.00 to 2.00 mg/L (as ClO <sub>2</sub> )
	Resolution	0.01 mg/L
	Accuracy @25°C (77°F)	±0.10 mg/L, ±5% of reading
	Method	Adaptation of Standard Methods for the Examination of Water and Wastewater, 18th ed., 4500 ClO <sub>2</sub> D
Measurement System	Light Source	light emitting diode
	Bandpass filter	525 nm
	Bandpass filter bandwidth	8 nm
	Bandpass filter wavelength accuracy	±1.0 nm
Additional Specifications	Light Detector	silicon photocell
	Cuvette type	round 24.6 mm diameter (22 mm inside)
	Auto logging	50 readings
	Display	128 x 64 pixel B/W LCD with backlight
Additional Specifications	Auto-off	after 15 minutes of inactivity (30 minutes before a READ measurement)
	Battery type / Life	alkaline 1.5 V AA (3) / > 800 measurements (without backlight)
	Environment	0 to 50°C (32 to 122°F); 0 to 100% RH, non-serviceable
	Dimensions	142.5 x 102.5 x 50.5 mm (5.6 x 4.0 x 2.0")
	Weight	380 g (13.4 oz.)
<b>Ordering Information</b>	<b>HI97779</b> is supplied with sample cuvettes (2), sample caps (2), plastic stoppers (2), 1.5V AA batteries (3), instrument quality certificate, and instruction manual. CAL Check standards and testing reagents sold separately	
<b>Reagents and Standards</b>	HI97779	<b>HI97779-11</b> CAL Check Standard cuvettes for chlorine dioxide (rapid)
		<b>HI96779-01</b> chlorine dioxide (rapid) reagents for 100 tests
		<b>HI96779-03</b> chlorine dioxide (rapid) reagents for 300 tests



HI97762

## Free Chlorine, Ultra Low Range Portable Photometer

- **Advanced LED optical system**
  - Innovative optical design that utilizes a reference detector and focusing lens to eliminate errors from changes in the light source and from imperfections in the glass cuvette.
  - LEDs have a much higher luminous efficiency, providing more light while using less power. They also produce little heat, which could otherwise affect electronic stability.
- **CAL Check™**
  - Validate instrument performance at any time using CAL Check cuvettes made with NIST traceable standards. The CAL Check screen guides the user step-by-step through the validation process and user calibration.
- **On-screen tutorial mode with animations**
  - Guides users step-by-step through the measurement process
- **Waterproof and floating IP67 case**
- **Unit of measure is displayed along with reading**
- **Built-in timer**
  - Built-in reaction timer that ensures consistency between tests.
- **Error messages on display**
  - Alerts to problems including no cap, high zero, and standard too low
- **GLP data**
  - Displays the last calibration date.
- **Auto logging**
- **Battery status indicator**
- **Auto-shut off**

### Significance of Use

As one of the most common forms of disinfectants used, chlorine improves water quality by destroying disease-producing microorganisms, and by reacting with other organic and inorganic substances. Chlorine levels must be actively monitored to ensure sufficient chlorine is present for disinfection, as well as to control adverse effects such as taste, odor, and potential reactions with organic matter to form harmful disinfection byproducts.

Specifications		HI97762 Free Chlorine, ULR
Measurement	Range	0.000 to 0.500 mg/L (as Cl <sub>2</sub> )
	Resolution	0.001 mg/L
	Accuracy @25°C (77°F)	±0.020 mg/L ±3% of reading at 25°C
	Method	Adaptation of Standard Method for the Examination of Water and Wastewater, 18th Edition, 4500-Cl <sub>G</sub> , DPD colorimetric method
Measurement System	Light Source	light emitting diode
	Bandpass filter	525 nm
	Bandpass filter bandwidth	8 nm
	Bandpass filter wavelength accuracy	±1.0 nm
	Light Detector	silicon photocell
	Cuvette type	round 24.6 mm diameter (22 mm inside)
Additional Specifications	Auto logging	50 readings
	Display	128 x 64 pixel B/W LCD with backlight
	Auto-off	after 15 minutes of inactivity (30 minutes before a READ measurement)
	Battery type / Life	alkaline 1.5 V AA (3) / > 800 measurements (without backlight)
	Environment	0 to 50°C (32 to 122°F); 0 to 100% RH, non-serviceable
	Dimensions	142.5 x 102.5 x 50.5 mm (5.6 x 4.0 x 2.0")
	Weight	380 g (13.4 oz.)

HI97762 is supplied with sample cuvettes (2), sample caps (2), plastic stoppers (2), 1.5V AA batteries (3), instrument quality certificate, and instruction manual.

CAL Check standards and testing reagents sold separately

### Ordering Information

HI97762C includes photometer, CAL Check cuvette A, CAL Check cuvette B for free chlorine ULR, sample cuvettes (2), sample caps (2), plastic stoppers (2), 1.5V AA batteries (3), cuvette wiping cloth, scissors, CAL Check standard certificate, instrument quality certificate, instruction manual, and HI7101412 rigid carrying case.

Reagents sold separately

Reagents and Standards		
HI97762		HI97762-11 CAL Check standard cuvettes for free chlorine ULR
		HI95762-01 free chlorine ULR reagents for (100 tests)
		HI95762-03 free chlorine ULR reagents for (300 tests)

HI97701

# Free Chlorine Portable Photometer

- **Advanced LED optical system**
  - Innovative optical design that utilizes a reference detector and focusing lens to eliminate errors from changes in the light source and from imperfections in the glass cuvette.
  - LEDs have a much higher luminous efficiency, providing more light while using less power. They also produce little heat, which could otherwise affect electronic stability.
- **CAL Check™**
  - Validate instrument performance at any time using CAL Check cuvettes made with NIST traceable standards. The CAL Check screen guides the user step-by-step through the validation process and user calibration.
- **On-screen tutorial mode with animations**
  - Guides users step-by-step through the measurement process
- **Waterproof and floating IP67 case**
- **Unit of measure is displayed along with reading**
- **Built-in timer**
  - Built-in reaction timer that ensures consistency between tests.
- **Error messages on display**
  - Alerts to problems including no cap, high zero, and standard too low
- **GLP data**
  - Displays the last calibration date.
- **Auto logging**
- **Battery status indicator**
- **Auto-shut off**



Specifications	HI97701 Free Chlorine	
Measurement	Range	0.00 to 5.00 mg/L (as Cl <sub>2</sub> )
	Resolution	0.01 mg/L
	Accuracy @25°C (77°F)	±0.03 mg/L ±3% of reading at 25 °C
	Method	adaptation of US EPA method 330.5, DPD Colorimetric method
Measurement System	Light Source	light emitting diode
	Bandpass filter	525 nm
	Bandpass filter bandwidth	8 nm
	Bandpass filter wavelength accuracy	±1.0 nm
Additional Specifications	Light Detector	silicon photodiode
	Cuvette type	round 24.6 mm diameter (22 mm inside)
	Auto logging	50 readings
	Display	128 x 64 pixel B/W LCD with backlight
Additional Specifications	Auto-off	after 15 minutes of inactivity (30 minutes before a READ measurement)
	Battery type / Life	alkaline 1.5 V AA (3) / > 800 measurements (without backlight)
	Environment	0 to 50°C (32 to 122°F); 0 to 100% RH, non-serviceable
	Dimensions	142.5 x 102.5 x 50.5 mm (5.6 x 4.0 x 2.0")
	Weight	380 g (13.4 oz.)

**HI97701** is supplied with sample cuvettes (2), sample caps (2), plastic stoppers (2), 1.5V AA batteries (3), instrument quality certificate, and instruction manual.  
CAL Check standards and testing reagents sold separately

**HI97701C** includes photometer, CAL Check standards, sample cuvettes (2), sample caps (2), plastic stoppers (2), 1.5V AA batteries (3), cuvette wiping cloth, scissors, CAL Check standard certificate, instrument quality certificate, instruction manual, and HI7101412 rigid carrying case.  
Reagents sold separately

Reagents and Standards	HI97701
	<b>HI97701-11</b> CAL Check standard cuvettes for free and total chlorine
	<b>HI93701-01</b> free chlorine powder reagent (100 tests)
	<b>HI93701-03</b> free chlorine powder reagent (300 tests)
	<b>HI93701-F</b> free chlorine liquid reagent (300 tests)

HI97761

# Chlorine, Total ULR Portable Photometers



- **Advanced LED optical system**
  - Innovative optical design that utilizes a reference detector and focusing lens to eliminate errors from changes in the light source and from imperfections in the glass cuvette.
  - LEDs have a much higher luminous efficiency, providing more light while using less power. They also produce little heat, which could otherwise affect electronic stability.
- **CAL Check™**
  - Validate instrument performance at any time using CAL Check cuvettes made with NIST traceable standards. The CAL Check screen guides the user step-by-step through the validation process and user calibration.
- **On-screen tutorial mode with animations**
  - Guides users step-by-step through the measurement process
- **Waterproof and floating IP67 case**
- **Unit of measure is displayed along with reading**
- **Built-in timer**
  - Built-in reaction timer that ensures consistency between tests.
- **Error messages on display**
  - Alerts to problems including no cap, high zero, and standard too low
- **GLP data**
  - Displays the last calibration date.
- **Auto logging**
- **Battery status indicator**
- **Auto-shut off**

## Specifications HI97761 Chlorine, Total Ultra Low Range

Measurement	Range	0.000 to 0.500 mg/L (ppm) (as Cl <sub>2</sub> )
	Resolution	0.001 mg/L
	Accuracy @25°C (77°F)	±0.020 mg/L ±3% of reading
	Method	adaptation of the USEPA method 330.5
Measurement System	Light Source	light emitting diode
	Bandpass filter	525 nm
	Bandpass filter bandwidth	8 nm
	Bandpass filter wavelength accuracy	±1.0 nm
	Light Detector	silicon photocell
Additional Specifications	Cuvette type	round 24.6 mm diameter (22 mm inside)
	Auto logging	50 readings
	Display	128 x 64 pixel B/W LCD with backlight
	Auto-off	after 15 minutes of inactivity (30 minutes before a READ measurement)
	Battery type / Life	alkaline 1.5 V AA (3) / > 800 measurements (without backlight)
	Environment	0 to 50°C (32 to 122°F); 0 to 100% RH, non-serviceable
	Dimensions	142.5 x 102.5 x 50.5 mm (5.6 x 4.0 x 2.0")
Weight	380 g (13.4 oz.)	

**HI97761** is supplied with sample cuvettes (2), sample caps (2), plastic stoppers (2), 1.5V AA batteries (3), instrument quality certificate, and instruction manual.

CAL Check standards and testing reagents sold separately

**HI97761C** includes photometer, CAL Check standards, sample cuvettes (2), sample caps (2), plastic stoppers (2), 1.5V AA batteries (3), cuvette wiping cloth, scissors, CAL Check standard certificate, instrument quality certificate, instruction manual, and rigid carrying case.

Reagents sold separately

## Ordering Information

## Reagents and Standards

HI97761	<b>HI97761-11</b> CAL Check Standard cuvettes for chlorine, total ULR
	<b>HI95761-01</b> chlorine, total ULR reagents for 100 tests
	<b>HI95762-03</b> chlorine, total ULR reagents for 300 tests

## Significance of Use

As one of the oldest and most common forms of disinfection, chlorine improves water quality by destroying disease-producing microorganisms, and by reacting with other organic and inorganic substances. Chlorine levels must be actively monitored to ensure sufficient chlorine is present for disinfection, as well as to control adverse effects such as taste, odor, and potential reactions with organic matter to form harmful disinfection byproducts.

HI97723 • HI97749

# Chromium (VI) HR and LR Portable Photometers

- Advanced LED optical system
  - Innovative optical design that utilizes a reference detector and focusing lens to eliminate errors from changes in the light source and from imperfections in the glass cuvette.
  - LEDs have a much higher luminous efficiency, providing more light while using less power. They also produce little heat, which could otherwise affect electronic stability.
- CAL Check™
  - Validate instrument performance at any time using CAL Check cuvettes made with NIST traceable standards. The CAL Check screen guides the user step-by-step through the validation process and user calibration.
- On-screen tutorial mode with animations
  - Guides users step-by-step through the measurement process
- Waterproof and floating IP67 case
- Unit of measure is displayed along with reading
- Built-in timer
  - Built-in reaction timer that ensures consistency between tests.
- Error messages on display
  - Alerts to problems including no cap, high zero, and standard too low
- GLP data
  - Displays the last calibration date.
- Auto logging
- Battery status indicator
- Auto-shut off

## Significance of Use

Hexavalent chromium salts are used in various industrial applications, such as in the manufacture of paints, dyes, explosives, and ceramics, and extensively in the metal finishing and plating industries. Due to its toxicity to humans, animals, and aquatic life, hexavalent chromium is actively monitored and neutralized in wastewater from the above industries.



Specifications	HI97749 Chromium (VI) LR	HI97723 Chromium (VI) HR	
Measurement	Range	0 to 300 µg/L (as Cr (VI))	0 to 1000 µg/L (ppb) (as Cr (VI))
	Resolution	1 µg/L	1 µg/L
	Accuracy @25°C (77°F)	±10 µg/L ±4% of reading	±5 µg/L ±4% of reading
Measurement System	Method	adaptation of the ASTM Manual of Water and Environmental Technology, D1687 Diphenylcarbohydrazide Method	
	Light Source	light emitting diode	
	Bandpass filter	525 nm	
	Bandpass filter bandwidth	8 nm	
	Bandpass filter wavelength accuracy	±1.0 nm	
Additional Specifications	Light Detector	silicon photocell	
	Cuvette type	round 24.6 mm diameter (22 mm inside)	
	Auto logging	50 readings	
	Display	128 x 64 pixel B/W LCD with backlight	
	Auto-off	after 15 minutes of inactivity (30 minutes before a READ measurement)	
	Battery type / Life	alkaline 1.5 V AA (3) / > 800 measurements (without backlight)	
	Environment	0 to 50°C (32 to 122°F); 0 to 100% RH, non-serviceable	
Dimensions	142.5 x 102.5 x 50.5 mm (5.6 x 4.0 x 2.0")		
Weight	380 g (13.4 oz.)		

**HI97723** and **HI97749** is supplied with sample cuvettes (2), sample caps (2), plastic stoppers (2), 1.5V AA batteries (3), instrument quality certificate, and instruction manual. CAL Check standards and testing reagents sold separately

## Ordering Information

**HI97723C** and **HI97749C** includes photometer, CAL Check standards, sample cuvettes (2), sample caps (2), plastic stoppers (2), 1.5V AA batteries (3), cuvette wiping cloth, scissors, CAL Check standard certificate, instrument quality certificate, instruction manual, and HI7101412 rigid carrying case. Reagents sold separately

Reagents and Standards	HI97749-11 CAL Check standard cuvettes for chromium(VI) LR
HI97749	<b>HI93749-01</b> chromium(VI) LR reagents for 100 tests
	<b>HI93749-03</b> chromium(VI) LR reagents for 300 tests
	<b>HI97723-11</b> CAL Check standard cuvettes for Chromium(VI) HR
HI97723	<b>HI93723-01</b> chromium(VI) HR reagents for 100 tests
	<b>HI93723-03</b> chromium(VI) HR reagents for 300 tests



HI97727

## Color of Water Portable Photometer

- **Advanced LED optical system**
  - Innovative optical design that utilizes a reference detector and focusing lens to eliminate errors from changes in the light source and from imperfections in the glass cuvette.
  - LEDs have a much higher luminous efficiency, providing more light while using less power. They also produce little heat, which could otherwise affect electronic stability.
- **CAL Check™**
  - Validate instrument performance at any time using CAL Check cuvettes made with NIST traceable standards. The CAL Check screen guides the user step-by-step through the validation process and user calibration.
- **On-screen tutorial mode with animations**
  - Guides users step-by-step through the measurement process
- **Waterproof and floating IP67 case**
- **Unit of measure is displayed along with reading**
- **Built-in timer**
  - Built-in reaction timer that ensures consistency between tests.
- **Error messages on display**
  - Alerts to problems including no cap, high zero, and standard too low
- **GLP data**
  - Displays the last calibration date.
- **Auto logging**
- **Battery status indicator**
- **Auto-shut off**

### Significance of Use

Used in natural water based applications, such as drinking water and municipal wastewater treatment, the color of water may dictate the presence of both unwanted inorganic and organic material; removal results in more suitable water for general and industrial applications. "Color" is applied in this context to represent "true color", where turbidity is removed. Where turbidity removal has been omitted, the term "apparent color" is then applied.

Specifications		HI97727 Color of Water
Measurement	Range	0 to 500 PCU (Platinum Cobalt Units)
	Resolution	1 PCU
	Accuracy @25°C (77°F)	±10 PCU ±5% of reading at 25°C
	Method	adaptation of the Standard Methods for the Examination of Water and Wastewater, 18th edition, Colorimetric Platinum Cobalt method
Measurement System	Light Source	light emitting diode
	Bandpass filter	420 nm
	Bandpass filter bandwidth	8 nm
	Bandpass filter wavelength accuracy	±1.0 nm
	Light Detector	silicon photocell
	Cuvette type	round 24.6 mm diameter (22 mm inside)
Additional Specifications	Auto logging	50 readings
	Display	128 x 64 pixel B/W LCD with backlight
	Auto-off	after 15 minutes of inactivity (30 minutes before a READ measurement)
	Battery type / Life	alkaline 1.5 V AA (3) / > 800 measurements (without backlight)
	Environment	0 to 50°C (32 to 122°F); 0 to 100% RH, non-serviceable
	Dimensions	142.5 x 102.5 x 50.5 mm (5.6 x 4.0 x 2.0")
	Weight	380 g (13.4 oz.)
Ordering Information	<b>HI97727</b> is supplied with sample cuvettes (2), sample caps (2), plastic stoppers (2), 1.5V AA batteries (3), instrument quality certificate, and instruction manual. CAL Check standards and testing reagents sold separately	
	<b>HI97727C</b> includes photometer, CAL Check standards, sample cuvettes (2), sample caps (2), plastic stoppers (2), 1.5V AA batteries (3), cuvette wiping cloth, scissors, CAL Check standard certificate, instrument quality certificate, instruction manual, and HI7101412 rigid carrying case. Reagents sold separately	
Reagents and Standards	HI97727	<b>HI97727-11</b> CAL Check standard cuvettes for color of water

HI97747 · HI97702

# Copper, Low and High Range Portable Photometers

- **Advanced LED optical system**
  - Innovative optical design that utilizes a reference detector and focusing lens to eliminate errors from changes in the light source and from imperfections in the glass cuvette.
  - LEDs have a much higher luminous efficiency, providing more light while using less power. They also produce little heat, which could otherwise affect electronic stability.
- **CAL Check™**
  - Validate instrument performance at any time using CAL Check cuvettes made with NIST traceable standards. The CAL Check screen guides the user step-by-step through the validation process and user calibration.
- **On-screen tutorial mode with animations**
  - Guides users step-by-step through the measurement process
- **Waterproof and floating IP67 case**
- **Unit of measure is displayed along with reading**
- **Built-in timer**
  - Built-in reaction timer that ensures consistency between tests.
- **Error messages on display**
  - Alerts to problems including no cap, high zero, and standard too low
- **GLP data**
  - Displays the last calibration date.
- **Auto logging**
- **Battery status indicator**
- **Auto-shut off**

## Significance of Use

Due to its malleability, thermal and electrical conductivity, and corrosion resistance, copper is used in a variety of industrial and technological applications. Copper may also be present in natural water and effluents due to widespread use to control biological growths in reservoirs and distribution pipes.



Specifications	HI97747 Copper, LR	HI97702 Copper, HR	
Measurement	Range	0.000 to 1.500 mg/L (ppm) (as Cu)	0.00 to 5.00 mg/L (ppm) (as Cu)
	Resolution	0.001 mg/L	0.01 mg/L (ppm)
	Accuracy @25°C (77°F)	±0.010 mg/L ±5% of reading	±0.02 mg/L ±4% of reading
	Method	adaptation of the USEPA approved bicinchoninate method	
Measurement System	Light Source	light emitting diode	
	Bandpass filter	575 nm	575 nm
	Bandpass filter bandwidth	8 nm	
	Bandpass filter wavelength accuracy	±1.0 nm	
Additional Specifications	Light Detector	silicon photocell	
	Cuvette type	round 24.6 mm diameter (22 mm inside)	
	Auto logging	50 readings	
	Display	128 x 64 pixel B/W LCD with backlight	
Additional Specifications	Auto-off	after 15 minutes of inactivity (30 minutes before a READ measurement)	
	Battery type / Life	alkaline 1.5 V AA (3) / > 800 measurements (without backlight)	
	Environment	0 to 50°C (32 to 122°F); 0 to 100% RH, non-serviceable	
	Dimensions	142.5 x 102.5 x 50.5 mm (5.6 x 4.0 x 2.0")	
Weight	380 g (13.4 oz.)		

**HI97747** and **HI97702** are supplied with sample cuvettes (2), sample caps (2), plastic stoppers (2), 1.5V AA batteries (3), instrument quality certificate, and instruction manual. CAL Check standards and testing reagents sold separately

## Ordering Information

**HI97747C** and **HI97702C** includes photometer, CAL Check standards, sample cuvettes (2), sample caps (2), plastic stoppers (2), 1.5V AA batteries (3), cuvette wiping cloth, scissors, CAL Check standard certificate, instrument quality certificate, instruction manual, and rigid carrying case.

Reagents sold separately

Reagents and Standards	HI97747	HI97702
Reagents and Standards		<b>HI97747-11</b> CAL Check standard cuvettes for copper LR
		<b>HI95747-01</b> copper LR reagents for 100 tests
		<b>HI95747-03</b> copper LR reagents for 300 tests
Reagents and Standards		<b>HI97702-11</b> CAL Check standard cuvettes for copper HR
		<b>HI93702-01</b> copper HR reagents for 100 tests
		<b>HI93702-03</b> copper HR reagents for 300 tests



HI97714

## Cyanide Portable Photometer



- **Advanced LED optical system**
  - Innovative optical design that utilizes a reference detector and focusing lens to eliminate errors from changes in the light source and from imperfections in the glass cuvette.
  - LEDs have a much higher luminous efficiency, providing more light while using less power. They also produce little heat, which could otherwise affect electronic stability.
- **CAL Check™**
  - Validate instrument performance at any time using CAL Check cuvettes made with NIST traceable standards. The CAL Check screen guides the user step-by-step through the validation process and user calibration.
- **On-screen tutorial mode with animations**
  - Guides users step-by-step through the measurement process
- **Waterproof and floating IP67 case**
- **Unit of measure is displayed along with reading**
- **Built-in timer**
  - Built-in reaction timer that ensures consistency between tests.
- **Error messages on display**
  - Alerts to problems including no cap, high zero, and standard too low
- **GLP data**
  - Displays the last calibration date.
- **Auto logging**
- **Battery status indicator**
- **Auto-shut off**

Specifications	HI97714 Cyanide	
Measurement	Range	0.000 to 0.200 mg/L (ppm) (as CN <sup>-</sup> )
	Resolution	0.001 mg/L
	Accuracy @25°C (77°F)	±0.005 mg/L ±3% of reading
	Method	adaptation of the Standard Methods for the Examination of Water and Wastewater, 18th edition, Pyridine-Pyrazolone method
Measurement System	Light Source	light emitting diode
	Bandpass filter	610 nm
	Bandpass filter bandwidth	8 nm
	Bandpass filter wavelength accuracy	±1.0 nm
	Light Detector	silicon photocell
	Cuvette type	round 24.6 mm diameter (22 mm inside)
Additional Specifications	Auto logging	50 readings
	Display	128 x 64 pixel B/W LCD with backlight
	Auto-off	after 15 minutes of inactivity (30 minutes before a READ measurement)
	Battery type / Life	alkaline 1.5 V AA (3) / > 800 measurements (without backlight)
	Environment	0 to 50°C (32 to 122°F); 0 to 100% RH, non-serviceable
	Dimensions	142.5 x 102.5 x 50.5 mm (5.6 x 4.0 x 2.0")
	Weight	380 g (13.4 oz.)

HI97714 is supplied with sample cuvettes (2), sample caps (2), plastic stoppers (2), 1.5V AA batteries (3), instrument quality certificate, and instruction manual.

CAL Check standards and testing reagents sold separately

HI97714C includes photometer, CAL Check standards, sample cuvettes (2), sample caps (2), plastic stoppers (2), 1.5V AA batteries (3), cuvette wiping cloth, scissors, CAL Check standard certificate, instrument quality certificate, instruction manual, and rigid carrying case.

Reagents sold separately

### Ordering Information

Reagents and Standards	HI97714	
		HI97714-11 CAL Check standard cuvettes for cyanide
		HI93714-01 cyanide reagents for 100 tests
		HI93714-03 cyanide reagents for 300 tests

### Significance of Use

The term "cyanide" refers to all of the CN groups in cyanide compounds that can be determined as the cyanide ion, CN<sup>-</sup>. Originating in water primarily from metallurgical and galvanic industrial plants, cyanide is highly toxic to the human nervous system.

HI97722

# Cyanuric Acid Photometer

- **Advanced LED optical system**
  - Innovative optical design that utilizes a reference detector and focusing lens to eliminate errors from changes in the light source and from imperfections in the glass cuvette.
  - LEDs have a much higher luminous efficiency, providing more light while using less power. They also produce little heat, which could otherwise affect electronic stability.
- **CAL Check™**
  - Validate instrument performance at any time using CAL Check cuvettes made with NIST traceable standards. The CAL Check screen guides the user step-by-step through the validation process and user calibration.
- **On-screen tutorial mode with animations**
  - Guides users step-by-step through the measurement process
- **Waterproof and floating IP67 case**
- **Unit of measure is displayed along with reading**
- **Built-in timer**
  - Built-in reaction timer that ensures consistency between tests.
- **Error messages on display**
  - Alerts to problems including no cap, high zero, and standard too low
- **GLP data**
  - Displays the last calibration date.
- **Auto logging**
- **Battery status indicator**
- **Auto-shut off**

## Significance of Use

Cyanuric acid (CYA) is best known as a stabilizing reagent for chlorine. It is widely applied in swimming pool and spa treatment programs to slow down the decomposition of hypochlorous acid. In outside pool areas, this process is accelerated by the effects of UV rays. When applied properly it can save up to 80% of normal chlorine consumption in pools during peak months.

Cyanuric acid is also used in chlorinated beaches, selective herbicides and whitening agents.



## Specifications

## HI97722 Cyanuric Acid

Measurement	Range	0 to 80 mg/L (ppm) (as CYA)
	Resolution	1 mg/L (ppm)
	Accuracy @25°C (77°F)	±1 mg/L ±15% of reading
	Method	adaptation of the turbidimetric method
Measurement System	Light Source	light emitting diode
	Bandpass filter	525 nm
	Bandpass filter bandwidth	8 nm
	Bandpass filter wavelength accuracy	±1.0 nm
Additional Specifications	Light Detector	silicon photocell
	Cuvette type	round 24.6 mm diameter (22 mm inside)
	Auto logging	50 readings
	Display	128 x 64 pixel B/W LCD with backlight
	Auto-off	after 15 minutes of inactivity (30 minutes before a READ measurement)
	Battery type / Life	alkaline 1.5 V AA (3) / > 800 measurements (without backlight)
	Environment	0 to 50°C (32 to 122°F); 0 to 100% RH, non-serviceable
Dimensions	142.5 x 102.5 x 50.5 mm (5.6 x 4.0 x 2.0")	
Weight	380 g (13.4 oz.)	

**HI97722** is supplied with sample cuvettes (2), sample caps (2), plastic stoppers (2), 1.5V AA batteries (3), instrument quality certificate, and instruction manual.

CAL Check standards and testing reagents sold separately

## Ordering Information

**HI97722C** includes photometer, CAL Check standards, sample cuvettes (2), sample caps (2), plastic stoppers (2), 1.5V AA batteries (3), cuvette wiping cloth, scissors, CAL Check standard certificate, instrument quality certificate, instruction manual, and rigid carrying case.

Reagents sold separately

Reagents and Standards	HI97722	<b>HI97722-11</b> CAL Check standard cuvettes for cyanuric acid
		<b>HI93722-01</b> cyanuric acid reagents for 100 tests
		<b>HI93722-03</b> cyanuric acid reagents for 300 tests

HI97729 · HI97739

# Fluoride, Low and High range Portable Photometers



- **Advanced LED optical system**
  - Innovative optical design that utilizes a reference detector and focusing lens to eliminate errors from changes in the light source and from imperfections in the glass cuvette.
  - LEDs have a much higher luminous efficiency, providing more light while using less power. They also produce little heat, which could otherwise affect electronic stability.
- **CAL Check™**
  - Validate instrument performance at any time using CAL Check cuvettes made with NIST traceable standards. The CAL Check screen guides the user step-by-step through the validation process and user calibration.
- **On-screen tutorial mode with animations**
  - Guides users step-by-step through the measurement process
- **Waterproof and floating IP67 case**
- **Unit of measure is displayed along with reading**
- **Built-in timer**
  - Built-in reaction timer that ensures consistency between tests.
- **Error messages on display**
  - Alerts to problems including no cap, high zero, and standard too low
- **GLP data**
  - Displays the last calibration date.
- **Auto logging**
- **Battery status indicator**
- **Auto-shut off**

Specifications		HI97729 Fluoride LR	HI97739 Fluoride HR
Measurement	Range	0.00 to 2.00 mg/L (ppm) (as F <sup>-</sup> )	0.0 to 20.0 mg/L (ppm) (as F <sup>-</sup> )
	Resolution	0.01 mg/L	0.1 mg/L
	Accuracy @25°C (77°F)	±0.03 mg/L ±3% of reading	±0.5 mg/L ±3% of reading
	Method	adaptation of the EPA method 340.1 and SPADNS method	adaptation of the SPADNS method
Measurement System	Light Source	light emitting diode	
	Bandpass filter	575 nm	575 nm
	Bandpass filter bandwidth	8 nm	
	Bandpass filter wavelength accuracy	±1.0 nm	
	Light Detector	silicon photocell	
	Cuvette type	round 24.6 mm diameter (22 mm inside)	
Additional Specifications	Auto logging	50 readings	
	Display	128 x 64 pixel B/W LCD with backlight	
	Auto-off	after 15 minutes of inactivity (30 minutes before a READ measurement)	
	Battery type / Life	alkaline 1.5 V AA (3) / > 800 measurements (without backlight)	
	Environment	0 to 50°C (32 to 122°F); 0 to 100% RH, non-serviceable	
	Dimensions	142.5 x 102.5 x 50.5 mm (5.6 x 4.0 x 2.0")	
	Weight	380 g (13.4 oz.)	

**HI97729** and **HI97739** are supplied with sample cuvettes (2), sample caps (2), plastic stoppers (2), 1.5V AA batteries (3), instrument quality certificate, and instruction manual. CAL Check standards and testing reagents sold separately

## Ordering Information

**HI97729C** and **HI97739C** includes photometer, CAL Check standards, sample cuvettes (2), sample caps (2), plastic stoppers (2), 2000 µL automatic pipette with instruction sheet, 1.5V AA batteries (3), cuvette wiping cloth, CAL Check standard certificate, instrument quality certificate, instruction manual, and rigid carrying case. Reagents sold separately

## Reagents and Standards

HI97729	<b>HI93703-53</b> reagent for reducing chlorine concentration
	<b>HI97729-11</b> CAL Check standard cuvettes for fluoride LR
	<b>HI93729-01</b> fluoride LR reagents for 100 tests
	<b>HI93729-03</b> fluoride LR reagents for 300 tests
HI97739	<b>HI97739-11</b> CAL Check standard cuvettes for fluoride HR
	<b>HI93739-01</b> fluoride HR reagents for 100 tests
	<b>HI93739-03</b> fluoride HR reagents for 300 tests

## Significance of Use

Fluoride is best known for preventing tooth decay. Water authorities often add fluoride to drinking water to maintain approximately a 1.0 mg/L (ppm) concentration. Fluoride can be found naturally in groundwater, particularly if a reservoir is in close proximity to seawater. While fluoride does help prevent tooth decay, too little can be ineffective while too much can cause staining of teeth.

HI97720 · HI97719

# Hardness Standard Method Portable Photometers

- **Advanced LED optical system**
  - Innovative optical design that utilizes a reference detector and focusing lens to eliminate errors from changes in the light source and from imperfections in the glass cuvette.
  - LEDs have a much higher luminous efficiency, providing more light while using less power. They also produce little heat, which could otherwise affect electronic stability.
- **CAL Check™**
  - Validate instrument performance at any time using CAL Check cuvettes made with NIST traceable standards. The CAL Check screen guides the user step-by-step through the validation process and user calibration.
- **On-screen tutorial mode with animations**
  - Guides users step-by-step through the measurement process
- **Waterproof and floating IP67 case**
- **Unit of measure is displayed along with reading**
- **Built-in timer**
  - Built-in reaction timer that ensures consistency between tests.
- **Error messages on display**
  - Alerts to problems including no cap, high zero, and standard too low
- **GLP data**
  - Displays the last calibration date.
- **Auto logging**
- **Battery status indicator**
- **Auto-shut off**

## Significance of Use

Water, with exception to distilled water, contains dissolved salts (magnesium and calcium carbonates). The concentration of these salts determines the water hardness, which can be expressed in calcium carbonate or magnesium carbonate. The sum of these two represents the total hardness level. In addition, water hardness is also related to the phenomenon of pipe rusting in water heating and cooling systems, reverse osmosis, and demineralization plants.



Specifications	HI97720 Ca Hardness	HI97719 Mg Hardness
Measurement	Range	0.00 to 2.70 mg/L (ppm) (as CaCO <sub>3</sub> )
	Resolution	0.01 mg/L
	Accuracy @25°C (77°F)	±0.11 mg/L ±5% of reading
Measurement System	Method	adaptation of the Standard Methods for the Examination of Water and Wastewater, 18th ed. Calmagite method
	Light Source	light emitting diode
	Bandpass filter	525nm
	Bandpass filter bandwidth	8 nm
	Bandpass filter wavelength accuracy	±1.0 nm
	Light Detector	silicon photocell
Additional Specifications	Cuvette type	round 24.6 mm diameter (22 mm inside)
	Auto logging	50 readings
	Display	128 x 64 pixel B/W LCD with backlight
	Auto-off	after 15 minutes of inactivity (30 minutes before a READ measurement)
Battery type / Life	alkaline 1.5 V AA (3) / > 800 measurements (without backlight)	
Environment	0 to 50°C (32 to 122°F); 0 to 100% RH, non-serviceable	
Dimensions	142.5 x 102.5 x 50.5 mm (5.6 x 4.0 x 2.0")	
Weight	380 g (13.4 oz.)	

## Ordering Information

**HI97720** and **HI97719** are supplied with sample cuvettes (2), sample caps (2), plastic stoppers (2), 1.5V AA batteries (3), instrument quality certificate, and instruction manual. CAL Check standards and testing reagents sold separately

**HI97720C** and **HI97719C** includes photometer, CAL Check standards, sample cuvettes (2), sample caps (2), plastic stoppers (2), 1.5V AA batteries (3), 1 mL syringe with tip, cuvette wiping cloth, CAL Check standard certificate, instrument quality certificate, instruction manual, and rigid carrying case.

Reagents sold separately

## Reagents and Standards

HI97720	<b>HI97720-11</b> CAL Check standard cuvettes for calcium hardness
	<b>HI93720-01</b> calcium hardness reagents for 100 tests
	<b>HI93720-03</b> calcium hardness reagents for 300 tests
HI97719	<b>HI97719-11</b> CAL Check standard cuvettes for magnesium hardness
	<b>HI93719-01</b> magnesium hardness reagents for 100 tests
	<b>HI93719-03</b> magnesium hardness reagents for 300 tests

HI97735

# Total Hardness Portable Photometer



- **Advanced LED optical system**
  - Innovative optical design that utilizes a reference detector and focusing lens to eliminate errors from changes in the light source and from imperfections in the glass cuvette.
  - LEDs have a much higher luminous efficiency, providing more light while using less power. They also produce little heat, which could otherwise affect electronic stability.
- **CAL Check™**
  - Validate instrument performance at any time using CAL Check cuvettes made with NIST traceable standards. The CAL Check screen guides the user step-by-step through the validation process and user calibration.
- **On-screen tutorial mode with animations**
  - Guides users step-by-step through the measurement process
- **Waterproof and floating IP67 case**
- **Unit of measure is displayed along with reading**
- **Built-in timer**
  - Built-in reaction timer that ensures consistency between tests.
- **Error messages on display**
  - Alerts to problems including no cap, high zero, and standard too low
- **GLP data**
  - Displays the last calibration date.
- **Auto logging**
- **Battery status indicator**
- **Auto-shut off**

## Specifications

		HI97735 Total Hardness
Total Hardness LR	Range	0 to 250 mg/L (as CaCO <sub>3</sub> )
	Resolution	1 mg/L
	Accuracy @25°C (77°F)	±5 mg/L ±4% of reading at 25°C
	Method	Adaptation of the EPA recommended method 130.1
Total Hardness MR	Range	200 to 500 mg/L (as CaCO <sub>3</sub> )
	Resolution	1 mg/L
	Accuracy @25°C (77°F)	±7 mg/L ±3% of reading at 25°C
	Method	Adaptation of the EPA recommended method 130.1
Total Hardness HR	Range	400 to 750 mg/L (as CaCO <sub>3</sub> )
	Resolution	1 mg/L
	Accuracy @25°C (77°F)	±10 mg/L ±2% of reading at 25°C
	Method	Adaptation of the EPA recommended method 130.1
Measurement System	Light Source	light emitting diode
	Bandpass filter	466 nm
	Bandpass filter bandwidth	8 nm
	Bandpass filter wavelength accuracy	±1.0 nm
	Light Detector	silicon photocell
	Cuvette type	round 24.6 mm diameter (22 mm inside)
Additional Specifications	Auto logging	50 readings
	Display	128 x 64 pixel B/W LCD with backlight
	Auto-off	after 15 minutes of inactivity (30 minutes before a READ measurement)
	Battery type / Life	alkaline 1.5 V AA (3) / > 800 measurements (without backlight)
	Environment	0 to 50°C (32 to 122°F); 0 to 100% RH, non-serviceable
	Dimensions	142.5 x 102.5 x 50.5 mm (5.6 x 4.0 x 2.0")
Weight	380 g (13.4 oz.)	

**HI97735** is supplied with sample cuvettes (2), sample caps (2), plastic stoppers (2), 1.5V AA batteries (3), instrument quality certificate, and instruction manual.

CAL Check standards and testing reagents sold separately

**HI97735C** includes photometer, CAL Check standards, sample cuvettes (2), sample caps (2), plastic stoppers (2), 1.5V AA batteries (3), cuvette wiping cloth, scissors, CAL Check standard certificate, instrument quality certificate, instruction manual, and HI7101414 rigid carrying case. Reagents sold separately

## Ordering Information

## Reagents and Standards

HI97735	<b>HI97735-11</b> CAL Check standard cuvettes for total hardness LR, MR, HR
	<b>HI93735-00</b> total hardness LR reagent for 100 tests
	<b>HI93735-01</b> total hardness MR reagent for 100 tests
	<b>HI93735-02</b> total hardness HR reagent for 100 tests
	<b>HI93735-0</b> reagents for 300 tests (LR - 100 tests, MR - 100 tests, HR - 100 tests)

See page 10.114 for standard reagents; see page 10.115 for CAL Check kits; see page 10.52 for general accessories

HI97704

# Hydrazine Portable Photometer

- **Advanced LED optical system**
  - Innovative optical design that utilizes a reference detector and focusing lens to eliminate errors from changes in the light source and from imperfections in the glass cuvette.
  - LEDs have a much higher luminous efficiency, providing more light while using less power. They also produce little heat, which could otherwise affect electronic stability.
- **CAL Check™**
  - Validate instrument performance at any time using CAL Check cuvettes made with NIST traceable standards. The CAL Check screen guides the user step-by-step through the validation process and user calibration.
- **On-screen tutorial mode with animations**
  - Guides users step-by-step through the measurement process
- **Waterproof and floating IP67 case**
- **Unit of measure is displayed along with reading**
- **Built-in timer**
  - Built-in reaction timer that ensures consistency between tests.
- **Error messages on display**
  - Alerts to problems including no cap, high zero, and standard too low
- **GLP data**
  - Displays the last calibration date.
- **Auto logging**
- **Battery status indicator**
- **Auto-shut off**

## Significance of Use

Hydrazine is a liquid chemical substance normally used in high pressure heating plants because of its properties as an oxygen inhibitor, helping to avoid scaling and corrosion. Hydrazine reacts with dissolved oxygen to yield nitrogen and water; this is an advantage over sulfite treatment because it does not produce any dissolved solids in the boiled water. Hydrazine is also used as an energy source in fuel elements, as a reducing agent for metal recovery, and as an intermediate in the production of insecticides, herbicides, pharmaceuticals, and many other chemical products.



Specifications	HI97704 Hydrazine	
Measurement	Range	0 to 400 µg/L (ppb) (as N <sub>2</sub> H <sub>4</sub> )
	Resolution	1 µg/L
	Accuracy @25°C (77°F)	±4% of full scale
Measurement System	Method	adaptation of the ASTM Manual of Water and Environmental Technology, method D1385-88 for natural and treated water
	Light Source	light emitting diode
	Bandpass filter	466 nm
	Bandpass filter bandwidth	8 nm
	Bandpass filter wavelength accuracy	±1.0 nm
	Light Detector	silicon photocell
Additional Specifications	Cuvette type	round 24.6 mm diameter (22 mm inside)
	Auto logging	50 readings
	Display	128 x 64 pixel B/W LCD with backlight
	Auto-off	after 15 minutes of inactivity (30 minutes before a READ measurement)
	Battery type / Life	alkaline 1.5 V AA (3) / > 800 measurements (without backlight)
	Environment	0 to 50°C (32 to 122°F); 0 to 100% RH, non-serviceable
	Dimensions	142.5 x 102.5 x 50.5 mm (5.6 x 4.0 x 2.0")
Weight	380 g (13.4 oz.)	

**HI97704** is supplied with sample cuvettes (2), sample caps (2), plastic stoppers (2), 1.5V AA batteries (3), instrument quality certificate, and instruction manual.

CAL Check standards and testing reagents sold separately

## Ordering Information

**HI97704C** includes photometer, CAL Check standards, sample cuvettes (2), sample caps (2), plastic stoppers (2), 1.5V AA batteries (3), cuvette wiping cloth, CAL Check standard certificate, instrument quality certificate, instruction manual, and rigid carrying case.

Reagents sold separately

Reagents and Standards	HI97704
	<b>HI97704-11</b> CAL Check standard cuvettes for hydrazine
	<b>HI93704-01</b> hydrazine reagents for 100 tests
	<b>HI93704-03</b> hydrazine reagents for 300 tests



HI97718

## Iodine Portable Photometer

- **Advanced LED optical system**
  - Innovative optical design that utilizes a reference detector and focusing lens to eliminate errors from changes in the light source and from imperfections in the glass cuvette.
  - LEDs have a much higher luminous efficiency, providing more light while using less power. They also produce little heat, which could otherwise affect electronic stability.
- **CAL Check™**
  - Validate instrument performance at any time using CAL Check cuvettes made with NIST traceable standards. The CAL Check screen guides the user step-by-step through the validation process and user calibration.
- **On-screen tutorial mode with animations**
  - Guides users step-by-step through the measurement process
- **Waterproof and floating IP67 case**
- **Unit of measure is displayed along with reading**
- **Built-in timer**
  - Built-in reaction timer that ensures consistency between tests.
- **Error messages on display**
  - Alerts to problems including no cap, high zero, and standard too low
- **GLP data**
  - Displays the last calibration date.
- **Auto logging**
- **Battery status indicator**
- **Auto-shut off**

Specifications	HI97718 Iodine	
Measurement	Range	0.0 to 12.5 mg/L (ppm) (as I <sub>2</sub> )
	Resolution	0.1 mg/L
	Accuracy @25°C (77°F)	±0.1 mg/L ±5% of reading
	Method	adaptation of the Standard Methods for the Examination of Water and Wastewater, 18th edition, DPD method
Measurement System	Light Source	light emitting diode
	Bandpass filter	525 nm
	Bandpass filter bandwidth	8 nm
	Bandpass filter wavelength accuracy	±1.0 nm
	Light Detector	silicon photocell
	Cuvette type	round 24.6 mm diameter (22 mm inside)
Additional Specifications	Auto logging	50 readings
	Display	128 x 64 pixel B/W LCD with backlight
	Auto-off	after 15 minutes of inactivity (30 minutes before a READ measurement)
	Battery type / Life	alkaline 1.5 V AA (3) / > 800 measurements (without backlight)
	Environment	0 to 50°C (32 to 122°F); 0 to 100% RH, non-serviceable
	Dimensions	142.5 x 102.5 x 50.5 mm (5.6 x 4.0 x 2.0")
	Weight	380 g (13.4 oz.)

**HI97718** is supplied with sample cuvettes (2), sample caps (2), plastic stoppers (2), 1.5V AA batteries (3), instrument quality certificate, and instruction manual.

CAL Check standards and testing reagents sold separately

**HI97718C** includes photometer, CAL Check standards, sample cuvettes (2), sample caps (2), plastic stoppers (2), 1.5V AA batteries (3), cuvette wiping cloth, CAL Check standard certificate, instrument quality certificate, instruction manual, and rigid carrying case.

Reagents sold separately

### Ordering Information

Reagents and Standards	HI97718	
		<b>HI97718-11</b> CAL Check standard cuvettes for iodine
		<b>HI93718-01</b> iodine reagents for 100 tests
		<b>HI93718-03</b> iodine reagents for 300 tests

### Significance of Use

The disinfectant properties of iodine have led to its use as an alternative to chlorine and bromine. Unlike chlorinated pools, water treated with iodine decreases eye irritation among swimmers and provides a level of disinfection more stable to adverse conditions. However, its toxic and corrosive properties, along with the difficulties of dissolving it in water, have limited its widespread acceptance. One of the most common applications of iodine is in poultry industry process water.

HI97746 • HI97721

# Iron, Low and High Range Portable Photometers

- **Advanced LED optical system**
  - Innovative optical design that utilizes a reference detector and focusing lens to eliminate errors from changes in the light source and from imperfections in the glass cuvette.
  - LEDs have a much higher luminous efficiency, providing more light while using less power. They also produce little heat, which could otherwise affect electronic stability.
- **CAL Check™**
  - Validate instrument performance at any time using CAL Check cuvettes made with NIST traceable standards. The CAL Check screen guides the user step-by-step through the validation process and user calibration.
- **On-screen tutorial mode with animations**
  - Guides users step-by-step through the measurement process
- **Waterproof and floating IP67 case**
- **Unit of measure is displayed along with reading**
- **Built-in timer**
  - Built-in reaction timer that ensures consistency between tests.
- **Error messages on display**
  - Alerts to problems including no cap, high zero, and standard too low
- **GLP data**
  - Displays the last calibration date.
- **Auto logging**
- **Battery status indicator**
- **Auto-shut off**

## Significance of Use

Iron is naturally present in water in low concentrations, but it reaches high concentrations in wastewater effluents. The iron concentration in water needs to be monitored because it becomes harmful above certain levels. In domestic water, for instance, iron can unpleasantly alter the taste, stain laundry, damage kitchenware and favor the growth of certain bacteria. Iron is also an indicator of ongoing corrosion in water cooling and heating systems. Moreover, iron is normally monitored in mining wastewater to avoid contamination.



Specifications	HI97746 Iron LR	HI97721 Iron HR	
Measurement	Range	0.00 to 1.60 mg/L (ppm) (as Fe)	0.00 to 5.00 mg/L (ppm) (as Fe)
	Resolution	0.01 mg/L	0.01 mg/L
	Accuracy @25°C (77°F)	±0.01 mg/L ±8% of reading	±0.04 mg/L ±2% of reading
	Method	adaptation of the TPTZ method	Adaptation of Standard Methods for the Examination of Water and Wastewater, 23rd Edition, 3500-Fe B, Phenanthroline Method
Measurement System	Light Source	light emitting diode	
	Bandpass filter	525 nm	
	Bandpass filter bandwidth	8 nm	
	Bandpass filter wavelength accuracy	±1.0 nm	
	Light Detector	silicon photocell	
	Cuvette type	round 24.6 mm diameter (22 mm inside)	
Additional Specifications	Auto logging	50 readings	
	Display	128 x 64 pixel B/W LCD with backlight	
	Auto-off	after 15 minutes of inactivity (30 minutes before a READ measurement)	
	Battery type / Life	alkaline 1.5 V AA (3) / > 800 measurements (without backlight)	
	Environment	0 to 50°C (32 to 122°F); 0 to 100% RH, non-serviceable	
	Dimensions	142.5 x 102.5 x 50.5 mm (5.6 x 4.0 x 2.0")	
	Weight	380 g (13.4 oz.)	

## Ordering Information

**HI97746** and **HI97721** is supplied with sample cuvettes (2), sample caps (2), plastic stoppers (2), 1.5V AA batteries (3), instrument quality certificate, and instruction manual. CAL Check standards and testing reagents sold separately

**HI97746C** and **HI97721C** includes photometer, CAL Check standards, sample cuvettes (2), sample caps (2), plastic stoppers (2), 1.5V AA batteries (3), cuvette wiping cloth, scissors, CAL Check standard certificate, instrument quality certificate, instruction manual, and rigid carrying case. Reagents sold separately

## Reagents and Standards

HI97746	<b>HI97746-11</b> CAL Check standard cuvette for iron LR
	<b>HI93746-01</b> iron LR reagents for 50 tests
	<b>HI93746-03</b> iron LR reagents for 150 tests
HI97721	<b>HI97721-11</b> CAL Check standard cuvettes for iron HR
	<b>HI93721-01</b> iron HR reagent for 50 tests
	<b>HI93701-03</b> iron HR reagent for 150 tests



HI97748 • HI97709

# Manganese, Low and High Range Portable Photometers



- **Advanced LED optical system**
  - Innovative optical design that utilizes a reference detector and focusing lens to eliminate errors from changes in the light source and from imperfections in the glass cuvette.
  - LEDs have a much higher luminous efficiency, providing more light while using less power. They also produce little heat, which could otherwise affect electronic stability.
- **CAL Check™**
  - Validate instrument performance at any time using CAL Check cuvettes made with NIST traceable standards. The CAL Check screen guides the user step-by-step through the validation process and user calibration.
- **On-screen tutorial mode with animations**
  - Guides users step-by-step through the measurement process
- **Waterproof and floating IP67 case**
- **Unit of measure is displayed along with reading**
- **Built-in timer**
  - Built-in reaction timer that ensures consistency between tests.
- **Error messages on display**
  - Alerts to problems including no cap, high zero, and standard too low
- **GLP data**
  - Displays the last calibration date.
- **Auto logging**
- **Battery status indicator**
- **Auto-shut off**

Specifications	HI97748 Manganese LR	HI97709 Manganese HR	
Measurement	Range	0 to 300 µg/L (as Mn)	0.0 to 20.0 mg/L (as Mn)
	Resolution	1 µg/L	0.1 mg/L
	Accuracy @25°C (77°F)	±10 µg/L ±3% of reading at 25°C	±0.2 mg/L ±3% of reading at 25°C
	Method	Adaptation of the PAN Method	adaptation of Standard Methods for the Examination of Water and Wastewater, 18th Edition, Periodate Method
Measurement System	Light Source	light emitting diode	
	Bandpass filter	575 nm	525 nm
	Bandpass filter bandwidth	8 nm	
	Bandpass filter wavelength accuracy	±1.0 nm	
	Light Detector	silicon photocell	
Additional Specifications	Cuvette type	round 24.6 mm diameter (22 mm inside)	
	Auto logging	50 readings	
	Display	128 x 64 pixel B/W LCD with backlight	
	Auto-off	after 15 minutes of inactivity (30 minutes before a READ measurement)	
	Battery type / Life	alkaline 1.5 V AA (3) / > 800 measurements (without backlight)	
	Environment	0 to 50°C (32 to 122°F); 0 to 100% RH, non-serviceable	
	Dimensions	142.5 x 102.5 x 50.5 mm (5.6 x 4.0 x 2.0")	
Weight	380 g (13.4 oz.)		

**HI97748** and **HI97709** is supplied with sample cuvettes (2), sample caps (2), plastic stoppers (2), 1.5V AA batteries (3), instrument quality certificate, and instruction manual. CAL Check standards and testing reagents sold separately

## Ordering Information

**HI97748C** and **HI97709C** includes photometer, CAL Check standards, sample cuvettes (2), sample caps (2), plastic stoppers (2), 1.5V AA batteries (3), cuvette wiping cloth, scissors, CAL Check standard certificate, instrument quality certificate, instruction manual, and rigid carrying case. Reagents sold separately

Reagents and Standards	HI97748	HI97709
	<b>HI97748-11</b> CAL Check standard cuvettes for manganese LR	
	<b>HI93748-01</b> manganese LR reagents for 50 tests	
	<b>HI93748-03</b> manganese LR reagents for 150 tests	
	<b>HI97709-11</b> CAL Check standard cuvettes for manganese HR	
	<b>HI93709-01</b> manganese HR reagents for 100 tests	
	<b>HI93709-03</b> manganese HR reagents for 300 tests	

See page 10.114 for standard reagents; see page 10.115 for CAL Check kits; see page 10.52 for general accessories

HI97730

# Molybdenum Portable Photometer

- **Advanced LED optical system**
  - Innovative optical design that utilizes a reference detector and focusing lens to eliminate errors from changes in the light source and from imperfections in the glass cuvette.
  - LEDs have a much higher luminous efficiency, providing more light while using less power. They also produce little heat, which could otherwise affect electronic stability.
- **CAL Check™**
  - Validate instrument performance at any time using CAL Check cuvettes made with NIST traceable standards. The CAL Check screen guides the user step-by-step through the validation process and user calibration.
- **On-screen tutorial mode with animations**
  - Guides users step-by-step through the measurement process
- **Waterproof and floating IP67 case**
- **Unit of measure is displayed along with reading**
- **Built-in timer**
  - Built-in reaction timer that ensures consistency between tests.
- **Error messages on display**
  - Alerts to problems including no cap, high zero, and standard too low
- **GLP data**
  - Displays the last calibration date.
- **Auto logging**
- **Battery status indicator**
- **Auto-shut off**

## Significance of Use

Molybdenum is commonly used in creating many types of high strength steel alloys. It has the ability to withstand extremely high temperatures without significant expansion or softening and displays a high resistance to corrosion. Wastewater from industries that use molybdenum must be treated to remove high amounts before discharge into the public collection system.



Specifications		HI97730 Molybdenum
Measurement	Range	0.0 to 40.0 mg/L (ppm) ( as Mo <sup>6+</sup> )
	Resolution	0.1 mg/L
	Accuracy @25°C (77°F)	±0.3 mg/L ±5% of reading
	Method	adaptation of the mercaptoacetic acid method
Measurement System	Light Source	light emitting diode
	Bandpass filter	420 nm
	Bandpass filter bandwidth	8 nm
	Bandpass filter wavelength accuracy	±1.0 nm
	Light Detector	silicon photocell
Additional Specifications	Cuvette type	round 24.6 mm diameter (22 mm inside)
	Auto logging	50 readings
	Display	128 x 64 pixel B/W LCD with backlight
	Auto-off	after 15 minutes of inactivity (30 minutes before a READ measurement)
	Battery type / Life	alkaline 1.5 V AA (3) / > 800 measurements (without backlight)
	Environment	0 to 50°C (32 to 122°F); 0 to 100% RH, non-serviceable
	Dimensions	142.5 x 102.5 x 50.5 mm (5.6 x 4.0 x 2.0")
Weight	380 g (13.4 oz.)	

**HI97730** is supplied with sample cuvettes (2), sample caps (2), plastic stoppers (2), 1.5V AA batteries (3), instrument quality certificate, and instruction manual.

CAL Check standards and testing reagents sold separately

### Ordering Information

**HI97730C** includes photometer, CAL Check standards, sample cuvettes (2), sample caps (2), plastic stoppers (2), 1.5V AA batteries (3), scissors, cuvette wiping cloth, CAL Check standard certificate, instrument quality certificate, instruction manual, and rigid carrying case.

Reagents sold separately

Reagents and Standards	HI97730	HI97730-11 CAL Check standard cuvettes for molybdenum
		HI93730-01 molybdenum reagents for 100 tests
		HI93730-03 molybdenum reagents for 300 tests

HI97740 · HI97726

# Nickel, Low and High Range Portable Photometers



- **Advanced LED optical system**
  - Innovative optical design that utilizes a reference detector and focusing lens to eliminate errors from changes in the light source and from imperfections in the glass cuvette.
  - LEDs have a much higher luminous efficiency, providing more light while using less power. They also produce little heat, which could otherwise affect electronic stability.
- **CAL Check™**
  - Validate instrument performance at any time using CAL Check cuvettes made with NIST traceable standards. The CAL Check screen guides the user step-by-step through the validation process and user calibration.
- **On-screen tutorial mode with animations**
  - Guides users step-by-step through the measurement process
- **Waterproof and floating IP67 case**
- **Unit of measure is displayed along with reading**
- **Built-in timer**
  - Built-in reaction timer that ensures consistency between tests.
- **Error messages on display**
  - Alerts to problems including no cap, high zero, and standard too low
- **GLP data**
  - Displays the last calibration date.
- **Auto logging**
- **Battery status indicator**
- **Auto-shut off**

Specifications		HI97740 Nickel LR	HI97726 Nickel HR
Measurement	Range	0.000 to 1.000 mg/L (ppm) (as Ni)	0.00 to 7.00 g/L (as Ni)
	Resolution	0.001 mg/L	0.01 g/L
	Accuracy @25°C (77°F)	±0.010 mg/L ±7% of reading	±0.07 mg/L ±4% of reading
	Method	adaptation of the 1-(2-pyridylazo)-2-naphthol PAN method	adaptation of the photometric method
Measurement System	Light Source	light emitting diode	
	Bandpass filter	575 nm	
	Bandpass filter bandwidth	8 nm	
	Bandpass filter wavelength accuracy	±1.0 nm	
	Light Detector	silicon photocell	
	Cuvette type	round 24.6 mm diameter (22 mm inside)	
Additional Specifications	Auto logging	50 readings	
	Display	128 x 64 pixel B/W LCD with backlight	
	Auto-off	after 15 minutes of inactivity (30 minutes before a READ measurement)	
	Battery type / Life	alkaline 1.5 V AA (3) / > 800 measurements (without backlight)	
	Environment	0 to 50°C (32 to 122°F); 0 to 100% RH, non-serviceable	
	Dimensions	142.5 x 102.5 x 50.5 mm (5.6 x 4.0 x 2.0")	
	Weight	380 g (13.4 oz.)	

**HI97740** and **HI97726** are supplied with sample cuvettes (2), sample caps (2), plastic stoppers (2), 1.5V AA batteries (3), instrument quality certificate, and instruction manual. CAL Check standards and testing reagents sold separately

## Ordering Information

**HI97740C** and **HI97726C** includes photometer, CAL Check standards, sample cuvettes (2), sample caps (2), plastic stoppers (2), 1.5V AA batteries (3), scissors, cuvette wiping cloth, CAL Check standard certificate, instrument quality certificate, instruction manual, and rigid carrying case. Reagents sold separately

Reagents and Standards		
HI97740	<b>HI97740-11</b>	CAL Check standard cuvettes for nickel LR
	<b>HI93740-01</b>	nickel LR reagents for 50 tests
	<b>HI93740-03</b>	nickel LR reagents for 150 tests
HI97726	<b>HI97726-11</b>	CAL Check standard cuvettes for nickel HR
	<b>HI93726-01</b>	nickel HR reagents for 100 tests
	<b>HI93726-03</b>	nickel HR reagents for 300 tests

## Significance of Use

Nickel is commonly utilized by the electroplating industry in processes utilizing stainless steel, cobalt, or nickel alloys. By using nickel in certain alloys, manufacturers can achieve a product that is highly resistant to chemical stress and exhibits a longer lifespan. Nickel is also an essential trace element that is essential for biological processes in livestock health and production. Nickel is also used in batteries, fuel cells, and hydrogenation of vegetable oils in the food industry.

HI97728

# Nitrate Portable Photometer

- **Advanced LED optical system**
  - Innovative optical design that utilizes a reference detector and focusing lens to eliminate errors from changes in the light source and from imperfections in the glass cuvette.
  - LEDs have a much higher luminous efficiency, providing more light while using less power. They also produce little heat, which could otherwise affect electronic stability.
- **CAL Check™**
  - Validate instrument performance at any time using CAL Check cuvettes made with NIST traceable standards. The CAL Check screen guides the user step-by-step through the validation process and user calibration.
- **On-screen tutorial mode with animations**
  - Guides users step-by-step through the measurement process
- **Waterproof and floating IP67 case**
- **Unit of measure is displayed along with reading**
- **Built-in timer**
  - Built-in reaction timer that ensures consistency between tests.
- **Error messages on display**
  - Alerts to problems including no cap, high zero, and standard too low
- **GLP data**
  - Displays the last calibration date.
- **Auto logging**
- **Battery status indicator**
- **Auto-shut off**

## Significance of Use

Nitrogen is abundant in the Earth's atmosphere and is present in water in the form of nitrate, nitrite, and ammonia. Plants use nitrogen as a nutrient to build proteins by tracking it in through their root system. Nitrate is formed in water mainly through rainfall, decomposition of organic matter, and runoff from manmade pollutants such as sewage waste and fertilizers. Almost all surface waters have a measurable level of nitrate, and a moderate amount is considered beneficial. Large amounts of nitrate, however, can lead to eutrophication which may result in decreased levels of dissolved oxygen in the water.



Specifications	HI97728 Nitrate	
Measurement	Range	0.0 to 30.0 mg/L (as NO <sub>3</sub> -N)
	Resolution	0.1 mg/L
	Accuracy @25°C (77°F)	±0.5 mg/L ±10% of reading at 25°C
Measurement System	Method	Adaptation of Cadmium Reduction method
	Light Source	light emitting diode
	Bandpass filter	525 nm
	Bandpass filter bandwidth	8 nm
	Bandpass filter wavelength accuracy	±1.0 nm
	Light Detector	silicon photocell
Additional Specifications	Cuvette type	round 24.6 mm diameter (22 mm inside)
	Auto logging	50 readings
	Display	128 x 64 pixel B/W LCD with backlight
	Auto-off	after 15 minutes of inactivity (30 minutes before a READ measurement)
	Battery type / Life	alkaline 1.5 V AA (3) / > 800 measurements (without backlight)
	Environment	0 to 50°C (32 to 122°F); 0 to 100% RH, non-serviceable
	Dimensions	142.5 x 102.5 x 50.5 mm (5.6 x 4.0 x 2.0")
Weight	380 g (13.4 oz.)	

**HI97728** is supplied with sample cuvettes (2), sample caps (2), plastic stoppers (2), 1.5V AA batteries (3), instrument quality certificate, and instruction manual.

CAL Check standards and testing reagents sold separately

### Ordering Information

**HI97728C** includes photometer, CAL Check standards, sample cuvettes (2), sample caps (2), plastic stoppers (2), 1.5V AA batteries (3), cuvette wiping cloth, scissors, CAL Check standard certificate, instrument quality certificate, instruction manual, and rigid carrying case.

Reagents sold separately

Reagents and Standards	HI97728
	<b>HI97728-11</b> CAL Check standard cuvettes for nitrate
	<b>HI93728-01</b> nitrate reagents for 100 tests
	<b>HI93728-03</b> nitrate reagents for 300 tests

HI97707 · HI97708

# Nitrite, Low and High Range Portable Photometers



- Advanced LED optical system
  - Innovative optical design that utilizes a reference detector and focusing lens to eliminate errors from changes in the light source and from imperfections in the glass cuvette.
  - LEDs have a much higher luminous efficiency, providing more light while using less power. They also produce little heat, which could otherwise affect electronic stability.
- CAL Check™
  - Validate instrument performance at any time using CAL Check cuvettes made with NIST traceable standards. The CAL Check screen guides the user step-by-step through the validation process and user calibration.
- On-screen tutorial mode with animations
  - Guides users step-by-step through the measurement process
- Waterproof and floating IP67 case
- Unit of measure is displayed along with reading
- Built-in timer
  - Built-in reaction timer that ensures consistency between tests.
- Error messages on display
  - Alerts to problems including no cap, high zero, and standard too low
- GLP data
  - Displays the last calibration date.
- Auto logging
- Battery status indicator
- Auto-shut off

Specifications	HI97707 Nitrite, LR	HI97708 Nitrite, HR	
Measurement	Range	0 to 600 µg/L (as NO <sub>2</sub> -N)	0 to 150 mg/L (ppm) (as NO <sub>2</sub> -N)
	Resolution	1 µg/L	1 mg/L
	Accuracy @25°C (77°F)	±20 µg/L ±4% of reading	±4 mg/L ±4% of reading
	Method	adaptation of an EPA approved diazotization method	adaptation of the Ferrous Sulfate method
Measurement System	Light Source	light emitting diode	
	Bandpass filter	466 nm	575 nm
	Bandpass filter bandwidth	8 nm	
	Bandpass filter wavelength accuracy	±1.0 nm	
	Light Detector	silicon photocell	
	Cuvette type	round 24.6 mm diameter (22 mm inside)	
Additional Specifications	Auto logging	50 readings	
	Display	128 x 64 pixel B/W LCD with backlight	
	Auto-off	after 15 minutes of inactivity (30 minutes before a READ measurement)	
	Battery type / Life	alkaline 1.5 V AA (3) / > 800 measurements (without backlight)	
	Environment	0 to 50°C (32 to 122°F); 0 to 100% RH, non-serviceable	
	Dimensions	142.5 x 102.5 x 50.5 mm (5.6 x 4.0 x 2.0")	
	Weight	380 g (13.4 oz.)	

## Ordering Information

**HI97707** and **HI97708** are supplied with sample cuvettes (2), sample caps (2), plastic stoppers (2), 1.5V AA batteries (3), instrument quality certificate, and instruction manual. CAL Check standards and testing reagents sold separately

**HI97707C** and **HI97708C** includes photometer, CAL Check standards, sample cuvettes (2), sample caps (2), plastic stoppers (2), 1.5V AA batteries (3), scissors, cuvette wiping cloth, CAL Check standard certificate, instrument quality certificate, instruction manual, and rigid carrying case. Reagents sold separately

## Reagents and Standards

HI97707	<b>HI97707-11</b> CAL Check standard cuvettes for nitrite LR
	<b>HI93707-01</b> nitrite LR reagents for 100 tests
	<b>HI93707-03</b> nitrite LR reagents for 300 tests
HI97708	<b>HI97708-11</b> CAL Check standard cuvettes for nitrite HR
	<b>HI93708-01</b> nitrite HR reagents for 100 tests
	<b>HI93708-03</b> nitrite HR reagents for 300 tests

## Significance of Use

Nitrites can be harmful to aquatic organisms even in low concentrations and for this reason, they are closely monitored in aquaculture facilities. In cooling towers, however, an adequate amount of nitrites is necessary to prevent corrosion. In high concentrations, they can be harmful to the environment and to humans. They are, therefore, normally monitored to verify the quality of water for domestic use, as well as lakes and ponds.

Nitrites are an intermediate product in the nitrogen cycle and are produced by ammonia oxidation with water, or even originate in industrial waste directly. They must not be present in drinking water.

HI97732

# Dissolved Oxygen Portable Photometer

- **Advanced LED optical system**
  - Innovative optical design that utilizes a reference detector and focusing lens to eliminate errors from changes in the light source and from imperfections in the glass cuvette.
  - LEDs have a much higher luminous efficiency, providing more light while using less power. They also produce little heat, which could otherwise affect electronic stability.
- **CAL Check™**
  - Validate instrument performance at any time using CAL Check cuvettes made with NIST traceable standards. The CAL Check screen guides the user step-by-step through the validation process and user calibration.
- **On-screen tutorial mode with animations**
  - Guides users step-by-step through the measurement process
- **Waterproof and floating IP67 case**
- **Unit of measure is displayed along with reading**
- **Built-in timer**
  - Built-in reaction timer that ensures consistency between tests.
- **Error messages on display**
  - Alerts to problems including no cap, high zero, and standard too low
- **GLP data**
  - Displays the last calibration date.
- **Auto logging**
- **Battery status indicator**
- **Auto-shut off**

## Significance of Use

Dissolved oxygen analysis measures the amount of gaseous oxygen (O<sub>2</sub>) dissolved in an aqueous solution. Dissolved oxygen is one of the most important parameters in aquatic systems. This gas is required for metabolism by aerobic organisms and also influences inorganic chemical reactions. Therefore, knowledge of the solubility and dynamics of oxygen distribution is essential to interpreting both biological and chemical processes within water bodies. Oxygen gets into water by diffusion from the surrounding air by aeration (rapid movement) and as a product of photosynthesis. The amount of oxygen that can dissolve in pure water is inversely proportional to the temperature of the water; the warmer the water, the less dissolved oxygen is present.



## Specifications

## HI97732 Oxygen, Dissolved

Measurement	Range	0.0 to 10.0 mg/L (ppm) (as O <sub>2</sub> )
	Resolution	0.1 mg/L
	Accuracy @25°C (77°F)	±0.4 mg/L ±3% of reading
Measurement System	Method	Adaptation of Standard Methods for Examination of Water and Wastewater (18th edition) Azide modified Winkler method reaction causes a yellow tint in sample
	Light Source	light emitting diode
	Bandpass filter	466 nm
	Bandpass filter bandwidth	8 nm
	Bandpass filter wavelength accuracy	±1.0 nm
	Light Detector	silicon photocell
	Cuvette type	round 24.6 mm diameter (22 mm inside)
Additional Specifications	Auto logging	50 readings
	Display	128 x 64 pixel B/W LCD with backlight
	Auto-off	after 15 minutes of inactivity (30 minutes before a READ measurement)
	Battery type / Life	alkaline 1.5 V AA (3) / > 800 measurements (without backlight)
	Environment	0 to 50°C (32 to 122°F); 0 to 100% RH, non-serviceable
Dimensions	142.5 x 102.5 x 50.5 mm (5.6 x 4.0 x 2.0")	
Weight	380 g (13.4 oz.)	

**HI97732** is supplied with sample cuvettes (2), sample caps (2), plastic stoppers (2), 1.5V AA batteries (3), instrument quality certificate, and instruction manual.

CAL Check standards and testing reagents sold separately

## Ordering Information

**HI97732C** includes photometer, CAL Check standards, sample cuvettes (2), sample caps (2), plastic stoppers (2), 1.5V AA batteries (3), cuvette wiping cloth, CAL Check standard certificate, instrument quality certificate, instruction manual, and rigid carrying case.

Reagents sold separately

Reagents and Standards	HI97732	<b>HI97732-11</b> CAL Check standard cuvettes for dissolved oxygen
		<b>HI93732-01</b> dissolved oxygen reagent for 100 tests
		<b>HI93732-03</b> dissolved oxygen reagent for 300 tests

HI97713 • HI97717

# Phosphate, Low and High Range Portable Photometers



- **Advanced LED optical system**
  - Innovative optical design that utilizes a reference detector and focusing lens to eliminate errors from changes in the light source and from imperfections in the glass cuvette.
  - LEDs have a much higher luminous efficiency, providing more light while using less power. They also produce little heat, which could otherwise affect electronic stability.
- **CAL Check™**
  - Validate instrument performance at any time using CAL Check cuvettes made with NIST traceable standards. The CAL Check screen guides the user step-by-step through the validation process and user calibration.
- **On-screen tutorial mode with animations**
  - Guides users step-by-step through the measurement process
- **Waterproof and floating IP67 case**
- **Unit of measure is displayed along with reading**
- **Built-in timer**
  - Built-in reaction timer that ensures consistency between tests.
- **Error messages on display**
  - Alerts to problems including no cap, high zero, and standard too low
- **GLP data**
  - Displays the last calibration date.
- **Auto logging**
- **Battery status indicator**
- **Auto-shut off**

Specifications	HI97713 Phosphate, LR	HI97717 Phosphate, HR	
Measurement	Range	0.00 to 2.50 mg/L (as PO <sub>4</sub> <sup>3-</sup> )	0.0 to 30.0 mg/L (ppm) (as PO <sub>4</sub> <sup>3-</sup> )
	Resolution	0.01 mg/L	0.1 mg/L
	Accuracy @25°C (77°F)	±0.04 mg/L ±4% of reading at 25°C	±1.0 mg/L ±4% of reading
	Method	Adaptation of the Ascorbic Acid method	Amino Acid Method, adapted from Standard Method for the Examination of Water and Wastewater
Measurement System	Light Source	light emitting diode	
	Bandpass filter	610 nm	525 nm
	Bandpass filter bandwidth	8 nm	
	Bandpass filter wavelength accuracy	±1.0 nm	
	Light Detector	silicon photocell	
Additional Specifications	Cuvette type	round 24.6 mm diameter (22 mm inside)	
	Auto logging	50 readings	
	Display	128 x 64 pixel B/W LCD with backlight	
	Auto-off	after 15 minutes of inactivity (30 minutes before a READ measurement)	
	Battery type / Life	alkaline 1.5 V AA (3) / > 800 measurements (without backlight)	
	Environment	0 to 50°C (32 to 122°F); 0 to 100% RH, non-serviceable	
	Dimensions	142.5 x 102.5 x 50.5 mm (5.6 x 4.0 x 2.0")	
	Weight	380 g (13.4 oz.)	

**HI97713** and **HI97717** are supplied with sample cuvettes (2), sample caps (2), plastic stoppers (2), 1.5V AA batteries (3), instrument quality certificate, and instruction manual. CAL Check standards and testing reagents sold separately.

## Ordering Information

**HI97713C** and **HI97717C** includes photometer, CAL Check standards, sample cuvettes (2), sample caps (2), plastic stoppers (2), 1.5V AA batteries (3), cuvette wiping cloth, scissors, CAL Check standard certificate, instrument quality certificate, instruction manual, and HI7101412 rigid carrying case.

Reagents sold separately

Reagents and Standards	HI97713	HI97717
	HI97713	<b>HI97713-11</b> CAL Check standard cuvettes for phosphate LR
		<b>HI93713-01</b> phosphate LR reagent for 100 tests
		<b>HI93713-03</b> phosphate LR reagent for 300 tests
	HI97717	<b>HI97717-11</b> CAL Check standard cuvettes for phosphate HR
		<b>HI93717-01</b> phosphate HR reagent for 100 tests
		<b>HI93717-03</b> phosphate HR reagent for 300 tests

## Significance of Use

Phosphates are used in a number of everyday products. Such as cola drinks to enhance flavor and tartness, antifreeze as a pH buffer, and french fries to delay darkening of the cut potatoes. They are also extensively used in detergents and cleaning fluids because of their ability to soften water and remove soil deposits.

Phosphate is essential for the growth and development of plant roots, stems, flowers and seeds, hence why it is one of the most commonly added to fertilizers. However, high concentrations of phosphates in agricultural runoff can cause environmental pollution, as they are a primary cause of eutrophication. Local laws govern the use of phosphates and the discharge levels into streams and waterways..

HI97706

# Phosphorus Portable Photometer

- **Advanced LED optical system**
  - Innovative optical design that utilizes a reference detector and focusing lens to eliminate errors from changes in the light source and from imperfections in the glass cuvette.
  - LEDs have a much higher luminous efficiency, providing more light while using less power. They also produce little heat, which could otherwise affect electronic stability.
- **CAL Check™**
  - Validate instrument performance at any time using CAL Check cuvettes made with NIST traceable standards. The CAL Check screen guides the user step-by-step through the validation process and user calibration.
- **On-screen tutorial mode with animations**
  - Guides users step-by-step through the measurement process
- **Waterproof and floating IP67 case**
- **Unit of measure is displayed along with reading**
- **Built-in timer**
  - Built-in reaction timer that ensures consistency between tests.
- **Error messages on display**
  - Alerts to problems including no cap, high zero, and standard too low
- **GLP data**
  - Displays the last calibration date.
- **Auto logging**
- **Battery status indicator**
- **Auto-shut off**

## Significance of Use

Common in natural systems, such as lakes, oceans, and soil, phosphorus is an essential element for plant and animal growth. However, when present in large concentrations, phosphorus can cause excessive microorganism and algae growth. For hobbyists with saltwater aquaria, a high amount of phosphorus can be problematic to fish and coral. The main source of phosphorus in reef aquaria is through food that is introduced on a daily basis, but it is also produced through the breakdown of plant material and excretion from fish. Replacement water can also be a source of phosphorus in aquaria, where tap water or reverse osmosis water is used to replace evaporated water and control the salt concentration in tanks. Both forms of water contain phosphorus, albeit in varying concentrations, and will have negative effects if the accumulating levels are not controlled. Phosphorus is also responsible for corrosion of piping systems if present in high enough amounts.



## Specifications

## HI97706 Phosphorus

Measurement	Range	0.0 to 15.0 mg/L (ppm) (as P)
	Resolution	0.1 mg/L
	Accuracy @25°C (77°F)	± 0.3 mg/L ±4% of reading
Measurement System	Method	Amino Acid Method, adapted from Standard Method for the Examination of Water and Wastewater
	Light Source	light emitting diode
	Bandpass filter	525 nm
	Bandpass filter bandwidth	8 nm
	Bandpass filter wavelength accuracy	±1.0 nm
	Light Detector	silicon photocell
	Cuvette type	round 24.6 mm diameter (22 mm inside)
Additional Specifications	Auto logging	50 readings
	Display	128 x 64 pixel B/W LCD with backlight
	Auto-off	after 15 minutes of inactivity (30 minutes before a READ measurement)
	Battery type / Life	alkaline 1.5 V AA (3) / > 800 measurements (without backlight)
	Environment	0 to 50°C (32 to 122°F); 0 to 100% RH, non-serviceable
	Dimensions	142.5 x 102.5 x 50.5 mm (5.6 x 4.0 x 2.0")
	Weight	380 g (13.4 oz.)

**HI97706** is supplied with sample cuvettes (2), sample caps (2), plastic stoppers (2), 1.5V AA batteries (3), instrument quality certificate, and instruction manual. CAL Check standards and testing reagents sold separately

## Ordering Information

**HI97706C** includes photometer, CAL Check standards, sample cuvettes (2), sample caps (2), plastic stoppers (2), 1.5V AA batteries (3), scissors, cuvette wiping cloth, CAL Check standard certificate, instrument quality certificate, instruction manual, and rigid carrying case.

Reagents sold separately

## Reagents and Standards

HI97706	<b>HI97706-11</b> CAL Check standard cuvettes for phosphorus
	<b>HI93706-01</b> phosphorus reagents for 100 tests
	<b>HI93706-03</b> phosphorus reagents for 300 tests



HI97750

# Potassium LR and MR Portable Photometers



- **Advanced LED optical system**
  - Innovative optical design that utilizes a reference detector and focusing lens to eliminate errors from changes in the light source and from imperfections in the glass cuvette.
  - LEDs have a much higher luminous efficiency, providing more light while using less power. They also produce little heat, which could otherwise affect electronic stability.
- **CAL Check™**
  - Validate instrument performance at any time using CAL Check cuvettes made with NIST traceable standards. The CAL Check screen guides the user step-by-step through the validation process and user calibration.
- **On-screen tutorial mode with animations**
  - Guides users step-by-step through the measurement process
- **Waterproof and floating IP67 case**
- **Unit of measure is displayed along with reading**
- **Built-in timer**
  - Built-in reaction timer that ensures consistency between tests.
- **Error messages on display**
  - Alerts to problems including no cap, high zero, and standard too low
- **GLP data**
  - Displays the last calibration date.
- **Auto logging**
- **Battery status indicator**
- **Auto-shut off**

## Specifications

### HI97750 Potassium LR and MR

Potassium LR	Range	0.0 to 10.0 mg/L (as K)
	Resolution	0.1 mg/L
	Accuracy @25°C (77°F)	±3.0 mg/L ±7 % of reading
	Method	adaptation of the Turbidimetric Tetraphenylborate Method
Potassium MR	Range	10 to 100 mg/L (as K)
	Resolution	0.1 mg/L
	Accuracy @25°C (77°F)	±10 mg/L ±7 % of reading
	Method	adaptation of the Turbidimetric Tetraphenylborate Method
Measurement System	Light Source	light emitting diode
	Bandpass filter	466 nm
	Bandpass filter bandwidth	8 nm
	Bandpass filter wavelength accuracy	±1.0 nm
	Light Detector	silicon photocell
	Cuvette type	round 24.6 mm diameter (22 mm inside)
Additional Specifications	Auto logging	50 readings
	Display	128 x 64 pixel B/W LCD with backlight
	Auto-off	after 15 minutes of inactivity (30 minutes before a READ measurement)
	Battery type / Life	alkaline 1.5 V AA (3) / > 800 measurements (without backlight)
	Environment	0 to 50°C (32 to 122°F); 0 to 100% RH, non-serviceable
	Dimensions	142.5 x 102.5 x 50.5 mm (5.6 x 4.0 x 2.0")
	Weight	380 g (13.4 oz.)

HI97750 is supplied with sample cuvettes (2), sample caps (2), plastic stoppers (2), 1.5V AA batteries (3), instrument quality certificate, and instruction manual.

CAL Check standards and testing reagents sold separately

HI97750C includes photometer, CAL Check standards, sample cuvettes (2), sample caps (2), plastic stoppers (2), 1.5V AA batteries (3), scissors, cuvette wiping cloth, CAL Check standard certificate, instrument quality certificate, instruction manual, and rigid carrying case.

Reagents sold separately

## Ordering Information

Reagents and Standards	HI97750	HI97750-11 CAL Check standard cuvettes for potassium
		HI93750-01 potassium reagents for 100 tests
		HI93750-03 potassium reagents for 300 tests

See page 10.114 for standard reagents; see page 10.115 for CAL Check kits; see page 10.52 for general accessories

HI97705 · HI97770

# Silica, Low and High Range Portable Photometers

- Advanced LED optical system
  - Innovative optical design that utilizes a reference detector and focusing lens to eliminate errors from changes in the light source and from imperfections in the glass cuvette.
  - LEDs have a much higher luminous efficiency, providing more light while using less power. They also produce little heat, which could otherwise affect electronic stability.
- CAL Check™
  - Validate instrument performance at any time using CAL Check cuvettes made with NIST traceable standards. The CAL Check screen guides the user step-by-step through the validation process and user calibration.
- On-screen tutorial mode with animations
  - Guides users step-by-step through the measurement process
- Waterproof and floating IP67 case
- Unit of measure is displayed along with reading
- Built-in timer
  - Built-in reaction timer that ensures consistency between tests.
- Error messages on display
  - Alerts to problems including no cap, high zero, and standard too low
- GLP data
  - Displays the last calibration date.
- Auto logging
- Battery status indicator
- Auto-shut off

## Significance of Use

The dissolved mineral forms of silica are found in all natural waters. Although silica is only slightly soluble in water and it can be found as ionic silica, silicates, and colloidal or suspended particles. The solubility of silica is highly dependent on pH, temperature, and pressure. Silica's presence in industrial applications, particularly in high pressure turbines, is undesirable because of scaling caused as silica precipitates out of solution at the elevated temperatures and pressures. Heating systems and reverse osmosis plants also require monitoring of silica to ensure process efficiency.



Specifications	HI97705 Silica LR	HI97770 Silica HR	
Measurement	Range	0.00 to 2.00 mg/L (ppm) (as SiO <sub>2</sub> )	0 to 200 mg/L (ppm) (as SiO <sub>2</sub> )
	Resolution	0.01 mg/L	1 mg/L
	Accuracy @25°C (77°F)	±0.03 mg/L ±3% of reading	±1 mg/L ±5% of reading
	Method	adaptation of the ASTM D859, heteropoly blue method	adaptation of the USEPA method 370.1 for drinking, surface and saline waters, domestic and industrial wastes and Standard Method 4500-SiO <sub>2</sub> C
Measurement System	Light Source	light emitting diode	
	Bandpass filter	610 nm	466 nm
	Bandpass filter bandwidth	8 nm	
	Bandpass filter wavelength accuracy	±1.0 nm	
Additional Specifications	Light Detector	silicon photocell	
	Cuvette type	round 24.6 mm diameter (22 mm inside)	
	Auto logging	50 readings	
Ordering Information	Display	128 x 64 pixel B/W LCD with backlight	
	Auto-off	after 15 minutes of inactivity (30 minutes before a READ measurement)	
	Battery type / Life	alkaline 1.5 V AA (3) / > 800 measurements (without backlight)	
	Environment	0 to 50°C (32 to 122°F); 0 to 100% RH, non-serviceable	
	Dimensions	142.5 x 102.5 x 50.5 mm (5.6 x 4.0 x 2.0")	
Reagents and Standards	Weight	380 g (13.4 oz.)	
	HI97705	<b>HI97705</b> and <b>HI97770</b> are supplied with sample cuvettes (2), sample caps (2), plastic stoppers (2), 1.5V AA batteries (3), instrument quality certificate, and instruction manual. CAL Check standards and testing reagents sold separately	
		<b>HI97705C</b> and <b>HI97770C</b> includes photometer, CAL Check standards, sample cuvettes (2), sample caps (2), plastic stoppers (2), 1.5V AA batteries (3), scissors, cuvette wiping cloth, CAL Check standard certificate, instrument quality certificate, instruction manual, and rigid carrying case. Reagents sold separately	
		<b>HI97705-11</b> CAL Check standard cuvettes for silica LR	<b>HI93705-01</b> silica LR reagents for 100 tests
	HI97770	<b>HI97770-11</b> CAL Check standard cuvettes for silica HR	
		<b>HI96770-01</b> silica HR reagents for 100 tests	
<b>HI96770-03</b> silica HR reagents for 300 tests			



HI97737

## Silver Portable Photometer

- **Advanced LED optical system**
  - Innovative optical design that utilizes a reference detector and focusing lens to eliminate errors from changes in the light source and from imperfections in the glass cuvette.
  - LEDs have a much higher luminous efficiency, providing more light while using less power. They also produce little heat, which could otherwise affect electronic stability.
- **CAL Check™**
  - Validate instrument performance at any time using CAL Check cuvettes made with NIST traceable standards. The CAL Check screen guides the user step-by-step through the validation process and user calibration.
- **On-screen tutorial mode with animations**
  - Guides users step-by-step through the measurement process
- **Waterproof and floating IP67 case**
- **Unit of measure is displayed along with reading**
- **Built-in timer**
  - Built-in reaction timer that ensures consistency between tests.
- **Error messages on display**
  - Alerts to problems including no cap, high zero, and standard too low
- **GLP data**
  - Displays the last calibration date.
- **Auto logging**
- **Battery status indicator**
- **Auto-shut off**

Specifications	HI97737 Silver	
Measurement	Range	0.000 to 1.000 mg/L (ppm) (as Ag)
	Resolution	0.001 mg/L
	Accuracy @25°C (77°F)	±0.020 mg/L ±5% of reading
	Method	adaptation of the PAN method
Measurement System	Light Source	light emitting diode
	Bandpass filter	575 nm
	Bandpass filter bandwidth	8 nm
	Bandpass filter wavelength accuracy	±1.0 nm
	Light Detector	silicon photocell
	Cuvette type	round 24.6 mm diameter (22 mm inside)
Additional Specifications	Auto logging	50 readings
	Display	128 x 64 pixel B/W LCD with backlight
	Auto-off	after 15 minutes of inactivity (30 minutes before a READ measurement)
	Battery type / Life	alkaline 1.5 V AA (3) / > 800 measurements (without backlight)
	Environment	0 to 50°C (32 to 122°F); 0 to 100% RH, non-serviceable
	Dimensions	142.5 x 102.5 x 50.5 mm (5.6 x 4.0 x 2.0")
	Weight	380 g (13.4 oz.)

**HI97737** is supplied with sample cuvettes (2), sample caps (2), plastic stoppers (2), 1.5V AA batteries (3), instrument quality certificate, and instruction manual.

CAL Check standards and testing reagents sold separately

### Ordering Information

**HI97737C** includes photometer, CAL Check standards, sample cuvettes (2), sample caps (2), plastic stoppers (2), 1.5V AA batteries (3), cuvette wiping cloth, CAL Check standard certificate, instrument quality certificate, instruction manual, and rigid carrying case.

Reagents sold separately

Reagents and Standards	HI97737	
		<b>HI97737-11</b> CAL Check standard cuvettes for silver
		<b>HI93737-01</b> silver reagents for 50 tests
		<b>HI93737-03</b> silver reagents for 150 tests

### Significance of Use

At times, silver is used in the disinfection of pools and spas, as well as in water filters. As small quantities of silver acts as a bacteriostatic agent preventing the growth of bacteria. The presence of silver in water is also indicative of pollution, mainly from film manufacturers, film processors, and surface finishers. Silver levels are closely monitored since its presence in drinking water can cause discoloration of the skin, eyes, and mucous membranes.

HI97751

# Sulfate Portable Photometer

- **Advanced LED optical system**
  - Innovative optical design that utilizes a reference detector and focusing lens to eliminate errors from changes in the light source and from imperfections in the glass cuvette.
  - LEDs have a much higher luminous efficiency, providing more light while using less power. They also produce little heat, which could otherwise affect electronic stability.
- **CAL Check™**
  - Validate instrument performance at any time using CAL Check cuvettes made with NIST traceable standards. The CAL Check screen guides the user step-by-step through the validation process and user calibration.
- **On-screen tutorial mode with animations**
  - Guides users step-by-step through the measurement process
- **Waterproof and floating IP67 case**
- **Unit of measure is displayed along with reading**
- **Built-in timer**
  - Built-in reaction timer that ensures consistency between tests.
- **Error messages on display**
  - Alerts to problems including no cap, high zero, and standard too low
- **GLP data**
  - Displays the last calibration date.
- **Auto logging**
- **Battery status indicator**
- **Auto-shut off**

## Significance of Use

Sulfate is naturally present within waters at different concentrations. However, sulfate concentrations are kept within strict ranges for drinking water, since this value can become high near mine drainage points. Sulfate is also rigorously tested in the production of beverages such as beer, due to its significant effect upon odor and taste. Sulfate is also rigorously tested in the production of beverages such as beer, due to its significant effect upon odor and taste.



## Specifications

	HI97751 Sulfate	
Measurement	Range	0 to 150 mg/L (ppm) (as SO <sub>4</sub> <sup>2-</sup> )
	Resolution	1 mg/L
	Accuracy @25°C (77°F)	±5 mg/L ±3% of reading
	Method	adaptation of the turbidimetric method; sulfate is precipitated with barium chloride crystals and light absorbance of the suspension is measured
Measurement System	Light Source	light emitting diode
	Bandpass filter	466 nm
	Bandpass filter bandwidth	8 nm
	Bandpass filter wavelength accuracy	±1.0 nm
	Light Detector	silicon photocell
	Cuvette type	round 24.6 mm diameter (22 mm inside)
	Auto logging	50 readings
	Display	128 x 64 pixel B/W LCD with backlight
Additional Specifications	Auto-off	after 15 minutes of inactivity (30 minutes before a READ measurement)
	Battery type / Life	alkaline 1.5 V AA (3) / > 800 measurements (without backlight)
	Environment	0 to 50°C (32 to 122°F); 0 to 100% RH, non-serviceable
	Dimensions	142.5 x 102.5 x 50.5 mm (5.6 x 4.0 x 2.0")
	Weight	380 g (13.4 oz.)

**HI97751** is supplied with sample cuvettes (2), sample caps (2), plastic stoppers (2), 1.5V AA batteries (3), instrument quality certificate, and instruction manual.

CAL Check standards and testing reagents sold separately

## Ordering Information

**HI97751C** includes photometer, CAL Check standards, sample cuvettes (2), sample caps (2), plastic stoppers (2), 1.5V AA batteries (3), scissors, cuvette wiping cloth, CAL Check standard certificate, instrument quality certificate, instruction manual, and rigid carrying case.

Reagents sold separately

Reagents and Standards	HI97751
	<b>HI97751-11</b> CAL Check standard cuvettes for sulfate
	<b>HI93751-01</b> sulfate reagents for 100 tests
	<b>HI93751-03</b> sulfate reagents for 300 tests



HI97731

## Zinc Portable Photometer

- **Advanced LED optical system**
  - Innovative optical design that utilizes a reference detector and focusing lens to eliminate errors from changes in the light source and from imperfections in the glass cuvette.
  - LEDs have a much higher luminous efficiency, providing more light while using less power. They also produce little heat, which could otherwise affect electronic stability.
- **CAL Check™**
  - Validate instrument performance at any time using CAL Check cuvettes made with NIST traceable standards. The CAL Check screen guides the user step-by-step through the validation process and user calibration.
- **On-screen tutorial mode with animations**
  - Guides users step-by-step through the measurement process
- **Waterproof and floating IP67 case**
- **Unit of measure is displayed along with reading**
- **Built-in timer**
  - Built-in reaction timer that ensures consistency between tests.
- **Error messages on display**
  - Alerts to problems including no cap, high zero, and standard too low
- **GLP data**
  - Displays the last calibration date.
- **Auto logging**
- **Battery status indicator**
- **Auto-shut off**

### Specifications

#### HI97731 Zinc

Measurement	Range	0.00 to 3.00 mg/L (ppm) (as Zn)
	Resolution	0.01 mg/L
	Accuracy @25°C (77°F)	±0.03 mg/L ±3% of reading
	Method	adaptation of the Standard Methods for the Examination of Water and Wastewater, 20th edition, Zincon method causes a brownish-green tint in the sample
Measurement System	Light Source	light emitting diode
	Bandpass filter	575 nm
	Bandpass filter bandwidth	8 nm
	Bandpass filter wavelength accuracy	±1.0 nm
	Light Detector	silicon photocell
	Cuvette type	round 24.6 mm diameter (22 mm inside)
Additional Specifications	Auto logging	50 readings
	Display	128 x 64 pixel B/W LCD with backlight
	Auto-off	after 15 minutes of inactivity (30 minutes before a READ measurement)
	Battery type / Life	alkaline 1.5 V AA (3) / > 800 measurements (without backlight)
	Environment	0 to 50°C (32 to 122°F); 0 to 100% RH, non-serviceable
	Dimensions	142.5 x 102.5 x 50.5 mm (5.6 x 4.0 x 2.0")
	Weight	380 g (13.4 oz.)

**HI97731** is supplied with sample cuvettes (2), sample caps (2), plastic stoppers (2), 1.5V AA batteries (3), instrument quality certificate, and instruction manual.

CAL Check standards and testing reagents sold separately

**HI97731C** includes photometer, CAL Check standards, sample cuvettes (2), sample caps (2), plastic stoppers (2), 1.5V AA batteries (3), scissors, cuvette wiping cloth, CAL Check standard certificate, instrument quality certificate, instruction manual, and rigid carrying case.

Reagents sold separately

### Ordering Information

### Reagents and Standards

HI97731	<b>HI97731-11</b> CAL Check standard cuvettes for zinc
	<b>HI93731-01</b> zinc reagents for 100 tests
	<b>HI93731-03</b> zinc reagents for 300 tests

### Significance of Use

Zinc is normally introduced into drinking water through industrial effluents, especially due to dezincification of brass and deterioration of galvanized iron. In addition to drinking water, zinc is measured in surface finishing, boilers and cooling towers, water conditioning, and effluent waters



IP67  
waterproof



Hanna Lab App  
Compatible

HI97115

## Marine Master Waterproof Wireless Multiparameter Photometer

*Measure pH, Alkalinity, Ammonia, Calcium, Magnesium, Nitrate LR, Nitrate HR, Nitrite ULR, and Phosphate ULR*

The HI97115 is a compact and versatile Marine multiparameter photometer designed to accurately determine pH, Alkalinity, Ammonia, Calcium, Magnesium, Nitrate, Nitrite, and Phosphate levels in aquariums and marine biology applications. The HI97115 is suitable for field and bench measurements.

The HI97115 can be used as a stand-alone photometer or can be connected to the Hanna Lab App with a compatible smart device via the integrated Bluetooth module. When connected, Hanna Lab App functions include measurement with the ability to add notes, data logging with extended storage capacity, data sharing, and the ability to create and save method groups.

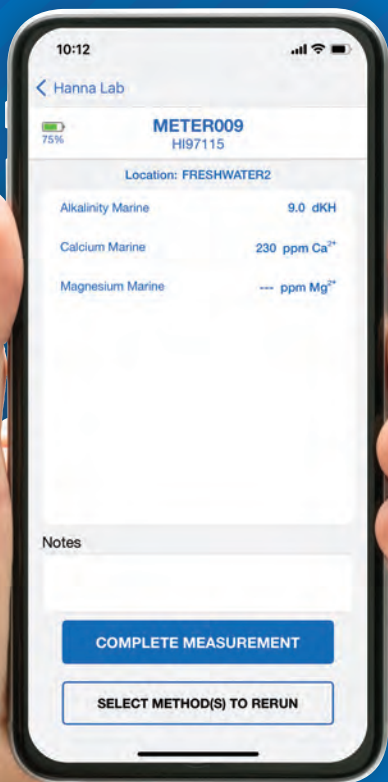

Samples can be named along with annotations



The Hanna Lab App is available on the App Store® and on Google Play.

## Hanna Lab App

When the photometer is paired with a compatible smart device, the Hanna Lab App adds an enhanced user experience to the HI97115. Features include: measurement with the ability add notes, data logging with extended storage capacity, data sharing, and the ability to create and save method groups.



View logged detail with date and time

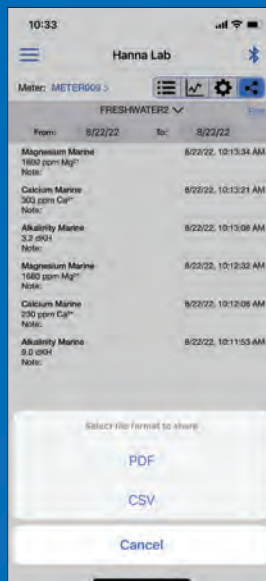

Share logged data in various formats



Control meter settings within the Hanna Lab App

### Backlit LCD

The 128 x 64 pixel LCD allows for a simplified user interface.

### Method and Parameter

Chosen parameter and method used are displayed along with the reading.

### Battery status indicator and auto-shut off

The auto-off feature automatically shuts off the meter after 15 minutes of inactivity in order to conserve battery life.

### Large cuvette size

The sample cell fits a round, glass cuvette with a 25 mm path length. The relatively long path length of the sample cuvette allows the light to pass through more of the sample solution, ensuring accurate measurements even in low absorbance samples. The cuvette holder features ridges to protect scratching of the optical path by the cuvette.

### Virtual keys

### Compact size

Measures 142.5 mm (5.6") x 102.5 mm (4") and only 50.5 mm (2") thick.

### Menu available at the touch of a button

### Dedicated help

A dedicated help key provides information relating to the current meter operation, and can be used at any stage in the setup or measurement process to show contextual help.





Waterproof and floating IP67 meter design

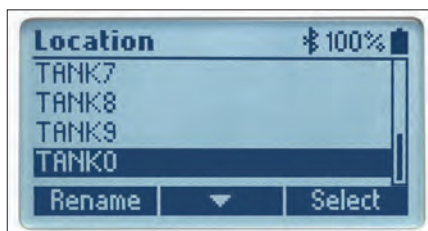

Option to select measurement location for better tracking consistency

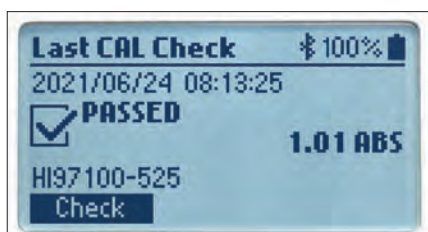

CAL Check™ validation and calibration

Validate instrument performance at any time using Hanna® CAL Check cuvettes certified against NIST-traceable reference instrument(s). The CAL Check screen guides the user step-by-step through the validation process and user calibration.

GLP data displays the last calibration date.

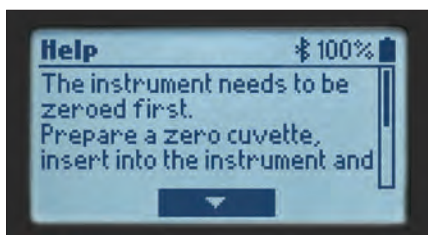

Backlit LCD and on-screen help



Built-in reaction timer that ensures consistency between tests.

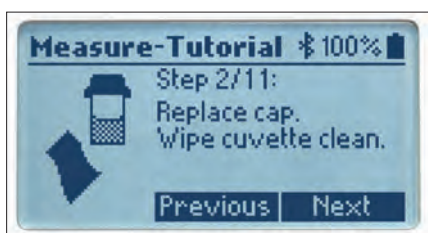

On-screen tutorial mode with animations

The built-in tutorial mode guides users step-by-step through the measurement process. It includes all steps required for sample preparation, the required reagents, and quantities.

Tutorial mode can be enabled or disabled from the setup menu.

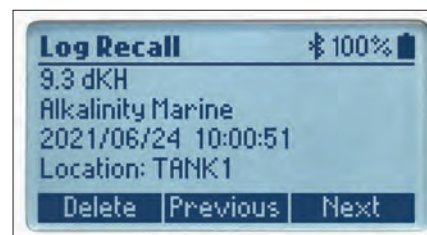

Includes auto-data logging features to easily record water testing results

The instrument features a data autolog function to help users keep track of all measurements. Every time a measurement is made the data is automatically saved.

The data log can hold 200 individual measurements (data points). When the log is full, the instrument rewrites the oldest data point.



Positive locking system

The Hanna positive-locking system ensures cuvettes are placed into the holder in the same position every time.

### Specifications

	Range	6.3 to 8.6 pH
Marine pH	Resolution	0.1 pH
	Accuracy	±0.2 pH of reading at 25 °C
	Method	colorimetric adaptation of the Phenol Red Method
	LED	525 nm
Marine Alkalinity	Range	0.0 to 20.0 dKH
	Resolution	0.1 dKH
	Accuracy	±0.3 dKH ±5% of reading at 25 °C
	Method	Colorimetric Method
Marine Ammonia	LED	610 nm
	Range	0.00 to 2.50 ppm (as NH <sub>3</sub> )
	Resolution	0.01 ppm
	Accuracy	±0.05 ppm ±5% of reading at 25 °C
	Method	adaptation of the Salicylate Method
	LED	610 nm

HI97115 pH, Alkalinity, Ammonia, Calcium, Magnesium, Nitrate LR, Nitrate HR, Nitrite ULR, and Phosphate ULR



Marine Calcium	Range	200 to 600 ppm
	Resolution	1 ppm
	Accuracy	±6% of reading at 25 °C
	Method	adaptation of the Zincon Method
	LED	610 nm
Marine Magnesium	Range	1000 to 1800 ppm (as Mg <sup>2+</sup> )
	Resolution	5 ppm
	Accuracy	±5% of reading at 25 °C
	Method	adaptation of the Colorimetric EDTA Method using calmagite indicator
	LED	610 nm
Marine Nitrate LR	Range	0.00 to 5.00 ppm (as NO <sub>3</sub> <sup>-</sup> )
	Resolution	0.01 ppm
	Accuracy	±0.25 ppm ±2% of reading at 25 °C
	Method	Zinc Reduction Method
	LED	525 nm
Marine Nitrate HR	Range	0.0 to 75.0 ppm (as NO <sub>3</sub> <sup>-</sup> )
	Resolution	0.1 ppm
	Accuracy	±2.0 ppm ±5% of reading at 25 °C
	Method	Zinc Reduction Method
	LED	525 nm
Marine Nitrite ULR	Range	0 to 200 ppb (as NO <sub>2</sub> <sup>-</sup> -N)
	Resolution	1 ppb
	Accuracy	±10 ppb ±4% of reading at 25 °C
	Method	adaptation of the EPA Diazotization Method 354.1
	LED	525 nm
Marine Phosphate ULR	Range	0.00 to 0.90 ppm
	Resolution	0.01 ppm
	Accuracy	±0.02 ppm ±5% of reading at 25 °C
	Method	adaptation of Standard Methods for the Examination of Water and Wastewater, 20th Edition, Ascorbic Acid Method
	LED	610 nm
Measurement system	Light source	Light Emitting Diode (LED)
	Bandpass filter	wavelength 525 nm & 610 nm bandwidth 8 nm wavelength accuracy ±1.0 nm
	Light detector	silicon photocell
	Cuvette Type	round 24.6 mm diameter (22 mm inside diameter)
Additional Specifications	Auto logging	200 readings
	Display	128 x 64 pixel B/W LCD with backlight
	Auto-off	after 15 minutes of inactivity (after 30 minutes of inactivity if a Zero has been done but not a Read)
	Battery type / Life	alkaline 1.5 V AA (3) / > 800 measurements (without backlight)
	Environment	0 to 50 °C (32 to 122 °F); 0 to 100% RH, non-serviceable
	Dimensions	142.5 x 102.5 x 50.5 mm (5.6 x 4.0 x 2.0")
	Weight	380 g (13.4 oz.); with batteries
	Casing	IP67 rating, floating

**HI97115** is supplied with sample cuvette (2 pcs.), sample cuvette cap (2 pcs.), 1.5V AA alkaline batteries (3 pcs.), instrument quality certificate, and quick reference guide with QR code for instruction manual download.

CAL Check standards and testing reagents sold separately

**HI97115C** and **HI97115UC** (ordering code for USA) is delivered in a rugged carrying case and is supplied with sample cuvette (2 pcs.), sample cuvette cap (2 pcs.), marine pH reagent, 30 mL dropper (1 pc.), Marine Alkalinity reagent, 30 mL bottle (1 pc.), Marine Ammonia starter kit - reagent A and C, 30 mL dropper (2 pcs., 1 of each), reagent B (reagent for 25 tests), Marine Calcium starter kit - reagent A, 30 mL bottle (1 pc.), reagent B (reagent for 25 tests), Marine Magnesium starter kit - reagent A, 120 mL bottle (1 pc.), Magnesium Indicator reagent (for 25 tests), Marine Nitrate High Range reagent (reagent for 25 tests), Marine Nitrite Ultra Low Range reagent (reagent for 25 tests), Marine Phosphate Ultra Low Range reagent (reagent for 25 tests), 1 mL graduated syringe with tip (2 pcs.), minipipette with tip (1 pc.), 3 mL Pasteur pipette (2 pcs.), 5 mL syringe (black printing) and tip (1 pc.), 5 mL syringe (blue printing) and tip (1 pc.), 1.5V AA Alkaline batteries (3 pcs.), cloth for wiping cuvettes, scissors, instrument quality certificate, and quick reference guide with QR code for instruction manual download.

CAL Check standards sold separately. Nitrate LR testing reagent not included.

## Ordering Information

## Reagents, Standards, and Accessories

<b>HI97105-11</b> CAL Check standard cuvettes for HI97105	<b>HI783-25</b> marine magnesium reagent - 25 tests
<b>HI758-26</b> marine calcium reagent - 25 tests	<b>HI784-25</b> marine ammonia reagent - 25 tests
<b>HI758U-26</b> marine calcium reagent - 25 tests (ordering code for USA)	<b>HI740270</b> 10 mL syringe with Luer Lock (1 pc.)
<b>HI764-25</b> marine nitrite ULR - 25 tests	<b>HI740271</b> Filter holder with Luer Lock (1 pc.)
<b>HI772-26</b> marine alkalinity reagent - 25 tests	<b>HI740272</b> 16 gauge blunt needle (6 pcs.)
<b>HI774-25</b> marine phosphate ULR reagent - 25 tests	<b>HI740273</b> marine nitrate LR measurement kit (1 pc.)
<b>HI780-25</b> marine pH reagent - approximately 100 tests	<b>HI740228</b> Filter disc (25 pcs.)
<b>HI781-25</b> marine nitrate LR reagent - 25 tests	<b>HI731360</b> glass cuvette with cap (2 pcs.)
<b>HI782-25</b> marine nitrate HR reagent - 25 tests	<b>HI7101419</b> blue carrying case for Marine Master photometer



HI97105

## Marine Master Waterproof Multiparameter Photometer

Measure pH, Alkalinity, Ammonia, Calcium, Magnesium, Nitrate LR, Nitrate HR, Nitrite ULR, and Phosphate ULR

The HI97105 is a compact and versatile Marine multiparameter photometer designed to accurately determine pH, Alkalinity, Ammonia, Calcium, Magnesium, Nitrate, Nitrite, and Phosphate levels in aquariums and marine biology applications. The HI97105 consolidates testing needs into one unit using the same reagents.

### • Precise and advanced LED optical system

- Innovative optical design that utilizes a reference detector and focusing lens to eliminate errors from changes in the light source and from imperfections in the glass cuvette.
- LEDs have a much higher luminous efficiency, providing more light while using less power. They also produce little heat, which could otherwise affect electronic stability.

### • CAL Check™ validation and calibration

- Validate instrument performance at any time using CAL Check cuvettes made with NIST traceable standards. The CAL Check screen guides the user step-by-step through the validation process and user calibration.

### • On-screen tutorial mode with animations

- Guides users step-by-step through the measurement process

### • Waterproof and floating IP67 meter design

### • Unit of measure is displayed along with reading

### • Includes auto data logging features to easily record water testing results

- The instrument features a data autolog function to help users keep track of all measurements. Every time a measurement is made the data is automatically saved. The data log can hold 200 individual measurements. When the data log is full (200 data points), the meter will rewrite the oldest data point.

### • Battery status indicator and auto-shut off

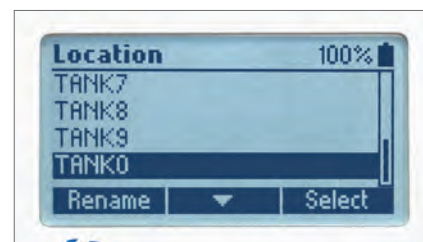

### • Option to select measurement location for better tracking consistency

### • Built-in timer

- Built-in reaction timer that ensures consistency between tests.

### • Error messages on display

- Alerts to problems including no cap, high zero, and standard too low

### • GLP data

- Displays the last calibration date.

## Specifications

## HI97105 pH, Alkalinity, Ammonia, Calcium, Magnesium, Nitrate LR, Nitrate HR, Nitrite ULR, and Phosphate ULR

Marine pH	Range	6.3 to 8.6 pH	
	Resolution	0.1 pH	
	Accuracy	±0.2 pH of reading at 25 °C	
	Method	colorimetric adaptation of the Phenol Red Method	
	LED	525 nm	
Marine Alkalinity	Range	0.0 to 20.0 dKH	
	Resolution	0.1 dKH	
	Accuracy	±0.3 dKH ±5% of reading at 25 °C	
	Method	Colorimetric Method	
	LED	610 nm	
Marine Ammonia	Range	0.00 to 2.50 ppm (as NH <sub>3</sub> )	
	Resolution	0.01 ppm	
	Accuracy	±0.05 ppm ±5% of reading at 25 °C	
	Method	Adaptation of the Salicylate Method	
	LED	610 nm	
Marine Calcium	Range	200 to 600 ppm	
	Resolution	1 ppm	
	Accuracy	±6% of reading at 25 °C	
	Method	adaptation of the Zincon Method	
	LED	610 nm	
Marine Magnesium	Range	1000 to 1800 ppm (as Mg <sup>2+</sup> )	
	Resolution	5 ppm	
	Accuracy	±5% of reading at 25 °C	
	Method	adaptation of the Colorimetric EDTA Method using calmagite indicator	
	LED	610 nm	
Marine Nitrate LR	Range	0.00 to 5.00 ppm (as NO <sub>3</sub> <sup>-</sup> )	
	Resolution	0.01 ppm	
	Accuracy	±0.25 ppm ±2% of reading at 25 °C	
	Method	Zinc Reduction Method	
	LED	525 nm	
Marine Nitrate HR	Range	0.0 to 75.0 ppm (as NO <sub>3</sub> <sup>-</sup> )	
	Resolution	0.1 ppm	
	Accuracy	±2.0 ppm ±5% of reading at 25 °C	
	Method	Zinc Reduction Method	
	LED	525 nm	
Marine Nitrite ULR	Range	0 to 200 ppb (as NO <sub>2</sub> <sup>-</sup> -N)	
	Resolution	1 ppb	
	Accuracy	±10 ppb ±4% of reading at 25 °C	
	Method	adaptation of the EPA Diazotization Method 354.1	
	LED	525 nm	
Marine Phosphate ULR	Range	0.00 to 0.90 ppm	
	Resolution	0.01 ppm	
	Accuracy	±0.02 ppm ±5% of reading at 25 °C	
	Method	adaptation of Standard Methods for the Examination of Water and Wastewater, 20th Edition, Ascorbic Acid Method	
	LED	610 nm	
Measurement system	Light source	Light Emitting Diode (LED)	
	Bandpass filter	wavelength	525 nm & 610 nm
		bandwidth	8 nm
		wavelength accuracy	±1.0 nm
	Light detector	silicon photocell	
Cuvette Type	round 24.6 mm diameter (22 mm inside diameter)		
Auto logging	200 readings		
Additional Specifications	Display	128 x 64 pixel B/W LCD with backlight	
	Auto-off	after 15 minutes of inactivity (after 30 minutes of inactivity if a Zero has been done but not a Read)	
	Battery type / Life	alkaline 1.5 V AA (3) / > 800 measurements (without backlight)	
	Environment	0 to 50 °C (32 to 122 °F); 0 to 100% RH, non-serviceable	
	Dimensions	142.5 x 102.5 x 50.5 mm (5.6 x 4.0 x 2.0")	
	Weight	380 g (13.4 oz.); with batteries	
	Casing	IP67 rating, floating	

## Ordering Information

**HI97105** is supplied with sample cuvette (2 pcs.), sample cuvette cap (2 pcs.), 1.5V AA alkaline batteries (3 pcs.), instrument quality certificate, and quick reference guide with QR code for instruction manual download.

CAL Check standards and testing reagents sold separately

## Reagents, Standards, and Accessories

<b>HI97105-11</b> CAL Check standard cuvettes for HI97105	<b>HI783-25</b> marine magnesium reagent - 25 tests
<b>HI758-26</b> marine calcium reagent - 25 tests	<b>HI784-25</b> marine ammonia reagent - 25 tests
<b>HI758U-26</b> marine calcium reagent - 25 tests (ordering code for USA)	<b>HI740270</b> 10 mL syringe with Luer Lock (1 pc.)
<b>HI764-25</b> marine nitrite ULR - 25 tests	<b>HI740271</b> Filter holder with Luer Lock (1 pc.)
<b>HI772-26</b> marine alkalinity reagent - 25 tests	<b>HI740272</b> 16 gauge blunt needle (6 pcs.)
<b>HI774-25</b> marine phosphate ULR reagent - 25 tests	<b>HI740273</b> marine nitrate LR measurement kit (1 pc.)
<b>HI780-25</b> marine pH Reagent - approximately 100 tests	<b>HI740228</b> filter disc (25 pcs.)
<b>HI781-25</b> marine nitrate LR Reagent - 25 tests	<b>HI731360</b> glass cuvette with cap (2 pcs.)
<b>HI782-25</b> marine nitrate HR reagent - 25 tests	<b>HI7101419</b> blue carrying case for Marine Master photometer



HI97101

## Bromine, Free and Total Chlorine, Cyanuric Acid, Iron LR, Iodine and pH Portable Photometer

- **Advanced LED optical system**
  - Innovative optical design that utilizes a reference detector and focusing lens to eliminate errors from changes in the light source and from imperfections in the glass cuvette.
  - LEDs have a much higher luminous efficiency, providing more light while using less power. They also produce little heat, which could otherwise affect electronic stability.
- **CAL Check™**
  - Validate instrument performance at any time using CAL Check cuvettes made with NIST traceable standards. The CAL Check screen guides the user step-by-step through the validation process and user calibration.
- **On-screen tutorial mode with animations**
  - Guides users step-by-step through the measurement process
- **Waterproof and floating IP67 case**
- **Unit of measure is displayed along with reading**
- **Built-in timer**
  - Built-in reaction timer that ensures consistency between tests.
- **Error messages on display**
  - Alerts to problems including no cap, high zero, and standard too low
- **GLP data**
  - Displays the last calibration date.
- **Auto logging**
- **Battery status indicator**
- **Auto-shut off**

## Specifications

## HI97101 Bromine, Chlorine, Cyanuric Acid, Iodine, Iron LR and pH

pH	Range	6.5 to 8.5 pH
	Resolution	0.1 pH
	Accuracy @25°C (77°F)	±0.1 pH
	Method	Phenol Red method
Chlorine, Free and Total	Range	0.00 to 5.00 mg/L (ppm)
	Resolution	0.01 mg/L
	Accuracy @25°C (77°F)	±0.03 mg/L ±3% of reading
	Method	adaptation of the USEPA method and Standard Method 4500-Cl G
Cyanuric Acid	Range (all methods)	0 to 80 mg/L (ppm)
	Resolution (all methods)	1 mg/L
	Accuracy @25°C (77°F)	±1 mg/L ±15% of reading
	Method	adaptation of the turbidimetric method
Iodine	Range	0.0 to 12.5 mg/L (ppm)
	Resolution	0.1 mg/L
	Accuracy @25°C (77°F)	±0.1 mg/L ±5% of reading
	Method	adaptation of the EPA, DPD method
Bromine	Range	0.00 to 10.00 mg/L (ppm)
	Resolution	0.01 mg/L
	Accuracy @25°C (77°F)	±0.08 mg/L ±3% of reading
	Method	adaptation of the EPA, DPD method
Iron LR	Range	0.00 to 1.60 mg/L (ppm)
	Resolution	0.01 mg/L
	Accuracy @25°C (77°F)	±0.01 mg/L ±8% or reading
	Method	adaptation of the TPTZ method
Measurement System	Light Source	light emitting diode
	Bandpass filter	525 nm
	Bandpass filter bandwidth	8 nm
	Bandpass filter wavelength accuracy	±1.0 nm
	Light Detector	silicon photocell
Additional Specifications	Cuvette type	round 24.6 mm diameter (22 mm inside)
	Auto logging	50 readings
	Display	128 x 64 pixel B/W LCD with backlight
	Auto-off	after 15 minutes of inactivity (30 minutes before a READ measurement)
	Battery type / Life	alkaline 1.5 V AA (3) / > 800 measurements (without backlight)
	Environment	0 to 50°C (32 to 122°F); 0 to 100% RH, non-serviceable
	Dimensions	142.5 x 102.5 x 50.5 mm (5.6 x 4.0 x 2.0")
	Weight	380 g (13.4 oz.)

**HI97101** is supplied with sample cuvettes (2), sample caps (2), plastic stoppers (2), 1.5V AA batteries (3), instrument quality certificate, and instruction manual.

CAL Check standards and testing reagents sold separately

## Ordering Information

**HI97101C** includes photometer, CAL Check standards, sample cuvettes (2), sample caps (2), plastic stoppers (2), 1.5V AA batteries (3), cuvette wiping cloth, CAL Check standard certificates, instrument quality certificate, instruction manual, and rigid carrying case.

Reagents sold separately

## Reagents and Standards

HI97101

**HI97701-11** CAL Check standard cuvettes for free and total chlorine

**HI93701-01** free chlorine reagents for 100 tests

**HI97710-11** CAL Check standard cuvettes for pH

**HI93710-01** pH reagents for 100 tests

**HI93711-01** total chlorine reagents for 100 tests

**HI97716-11** CAL Check standard cuvettes for bromine

**HI93716-01** bromine reagents for 100 tests

**HI97718-11** CAL Check standard cuvettes for iodine

**HI93718-01** iodine reagents for 100 tests

**HI97722-11** CAL Check standard cuvettes for cyanuric acid

**HI93722-01** cyanuric acid reagents for 100 tests

**HI97746-11** CAL Check standard cuvettes for iron

**HI93746-01** iron LR reagents for 50 tests



HI97104 · HI971044

## pH, Alkalinity, Free and Total Chlorine and Cyanuric Acid Portable Photometer

The HI97104 and HI971044 portable photometers measure five important parameters in the treatment and disinfection of drinking water, wastewater and swimming pools.

- **Advanced LED optical system**
  - Innovative optical design that utilizes a reference detector and focusing lens to eliminate errors from changes in the light source and from imperfections in the glass cuvette.
  - LEDs have a much higher luminous efficiency, providing more light while using less power. They also produce little heat, which could otherwise affect electronic stability.
- **CAL Check™**
  - Validate instrument performance at any time using CAL Check cuvettes made with NIST traceable standards. The CAL Check screen guides the user step-by-step through the validation process and user calibration.
- **On-screen tutorial mode with animations**
  - Guides users step-by-step through the measurement process
- **Waterproof and floating IP67 case**
- **Unit of measure is displayed along with reading**
- **Built-in timer**
  - Built-in reaction timer that ensures consistency between tests.

- **Error messages on display**
  - Alerts to problems including no cap, high zero, and standard too low
- **GLP data**
  - Displays the last calibration date.
- **Auto logging**
- **Battery status indicator**
- **Auto-shut off**

### Significance of Use

Chlorine is a widely used disinfectant, and in order for it to be effective, the pH of the water should be less than 8.0.

Alkalinity is buffering capacity of the water, when alkalinity values are low the pH will be hard to maintain.

In swimming pools, spas, and similar applications, cyanuric acid helps to increase the life of chlorine by stabilizing it and preventing its breakdown, especially in sunlight. Frequent testing of both cyanuric acid and pH helps to minimize chlorine consumption.



HI97104 pH, Alkalinity, Free and Total Chlorine, Cyanuric Acid

HI971044 pH, Alkalinity, Free and Total Chlorine, Cyanuric Acid

Specifications		
pH	Range	6.5 to 8.5 pH
	Resolution	0.1 pH
	Accuracy @25°C (77°F)	±0.1 pH of reading at 25°C
	Method	adaptation of the Phenol Red method
Alkalinity	Range	0 to 500 mg/L (as CaCO <sub>3</sub> )
	Resolution	1 mg/L
	Accuracy @25°C (77°F)	±5 mg/L ±5% of reading at 25°C
	Method	Colorimetric method
Chlorine, Free and Total	Range (all methods)	0.00 to 5.00 mg/L (as Cl <sub>2</sub> )
	Resolution (all methods)	0.01 mg/L
	Accuracy @25°C (77°F) (all methods)	±0.03 mg/L ±3% of reading at 25°C
	Method	adaptation of the EPA DPD method 330.5
Cyanuric Acid	Range	0 to 80 mg/L (as CYA)
	Resolution	1 mg/L
	Accuracy @25°C (77°F)	±1 mg/L ±15% of reading at 25 °C
	Method	adaptation of the turbidimetric method
Measurement System	Light Source	light emitting diode
	Bandpass filters	525 nm and 610 nm
	Bandpass filter bandwidth	8 nm
	Bandpass filter wavelength accuracy	±1.0 nm
	Light Detector	silicon photocell
	Cuvette type	round 24.6 mm diameter (22 mm inside)
Additional Specifications	Auto logging	50 readings
	Display	128 x 64 pixel B/W LCD with backlight
	Auto-off	after 15 minutes of inactivity (30 minutes before a READ measurement)
	Battery type / Life	alkaline 1.5 V AA (3) / > 800 measurements (without backlight)
	Environment	0 to 50°C (32 to 122°F); 0 to 100% RH, non-serviceable
	Dimensions	142.5 x 102.5 x 50.5 mm (5.6 x 4.0 x 2.0")
	Weight	380 g (13.4 oz.)

**HI97104** and **HI971044** is supplied with sample cuvettes (2), sample caps (2), plastic stoppers (2), 1.5V AA batteries (3), instrument quality certificate, and instruction manual.

CAL Check standards and testing reagents sold separately

### Ordering Information

**HI97104C** and **HI971044C** includes photometer, CAL Check standards, sample cuvettes (2), sample caps (2), plastic stoppers (2), 1.5V AA batteries (3), cuvette wiping cloth, scissors, CAL Check standard certificate, instrument quality certificate, instruction manual, and HI7101414 rigid carrying case.

Reagents sold separately

Reagents and Standards		
HI97104 / HI971044		<b>HI97775-11</b> CAL Check standard cuvettes for alkalinity
		<b>HI775-26</b> alkalinity reagent
		<b>HI97722-11</b> CAL Check standard cuvettes for cyanuric acid
		<b>HI93722-01</b> cyanuric acid reagent for 100 tests
		<b>HI93722-03</b> cyanuric acid reagent for 300 tests
		<b>HI97701-11</b> CAL Check standard cuvettes for free and total chlorine
		<b>HI93701-01</b> free chlorine powder reagent 100 tests
		<b>HI93701-03</b> free chlorine powder reagent for 300 tests
		<b>HI93701-F</b> free chlorine liquid reagent for 300 tests
		<b>HI93711-01</b> total chlorine powder reagent 100 tests
		<b>HI93711-03</b> total chlorine powder reagent for 300 tests
		<b>HI93701-T</b> total chlorine liquid reagent for 300 tests
		<b>HI93755-53</b> chlorine removal reagent
		<b>HI977794-11</b> CAL Check standard cuvettes for swimming pool pH
		<b>HI93710-01</b> pH reagent for 100 tests
	<b>HI93710-03</b> pH reagent for 300 tests	



HI97725

## Free and Total Chlorine, Cyanuric Acid and pH Portable Photometer

*for Legionella Protection*

- **Advanced LED optical system**
  - Innovative optical design that utilizes a reference detector and focusing lens to eliminate errors from changes in the light source and from imperfections in the glass cuvette.
  - LEDs have a much higher luminous efficiency, providing more light while using less power. They also produce little heat, which could otherwise affect electronic stability.
- **CAL Check™**
  - Validate instrument performance at any time using CAL Check cuvettes made with NIST traceable standards. The CAL Check screen guides the user step-by-step through the validation process and user calibration.
- **On-screen tutorial mode with animations**
  - Guides users step-by-step through the measurement process
- **Waterproof and floating IP67 case**
- **Unit of measure is displayed along with reading**
- **Built-in timer**
  - Built-in reaction timer that ensures consistency between tests.
- **Error messages on display**
  - Alerts to problems including no cap, high zero, and standard too low

- **GLP data**
  - Displays the last calibration date.
- **Auto logging**
- **Battery status indicator**
- **Auto-shut off**

### Legionella

Legionella species is the agent that causes human Legionnaires' disease as well as the lesser form, Pontiac Fever. Transmission is facilitated by the inhalation of mist droplets containing the Legionella bacteria.

Common sources of Legionella include cooling towers used in industrial cooling water systems as well as in large central air conditioning systems, domestic hot water systems, fountains, and similar disseminators that draw from a public water supply. Natural sources include freshwater ponds and creeks.

Since Legionella is especially harmful to people with weakened immune systems, it should be actively checked for in the water systems of hospitals and nursing homes.



Specifications		HI97725 Chlorine, Cyanuric Acid and pH
Chlorine, Free	Range	0.00 to 5.00 mg/L (ppm)
	Resolution	0.01 mg/L
	Accuracy @25°C (77°F)	±0.03 mg/L ±3% of reading
	Method	adaptation of the EPA recommended DPD method 330.5 and standard method 4500-CL G
Chlorine, Total	Range	0.00 to 5.00 mg/L (ppm)
	Resolution	0.01 mg/L
	Accuracy @25°C (77°F)	±0.03 mg/L ±3% of reading
	Method	adaptation of the EPA recommended DPD method 330.5 and standard method 4500-CL G
Cyanuric Acid	Range	0 to 80 mg/L (ppm)
	Resolution	1 mg/L
	Accuracy @25°C (77°F)	±1 mg/L ±15% of reading
	Method	adaptation of the Turbidimetric method
pH	Range	6.5 to 8.5 pH
	Resolution	0.1 pH
	Accuracy @25°C (77°F)	±0.1 pH
	Method	Phenol Red method
Measurement System	Light Source	light emitting diode
	Bandpass filter	525 nm
	Bandpass filter bandwidth	8 nm
	Bandpass filter wavelength accuracy	±1.0 nm
	Light Detector	silicon photocell
	Cuvette type	round 24.6 mm diameter (22 mm inside)
Additional Specifications	Auto logging	50 readings
	Display	128 x 64 pixel B/W LCD with backlight
	Auto-off	after 15 minutes of inactivity (30 minutes before a READ measurement)
	Battery type / Life	alkaline 1.5 V AA (3) / > 800 measurements (without backlight)
	Environment	0 to 50°C (32 to 122°F); 0 to 100% RH, non-serviceable
	Dimensions	142.5 x 102.5 x 50.5 mm (5.6 x 4.0 x 2.0")
	Weight	380 g (13.4 oz.)

**HI97725** is supplied with sample cuvettes (2), sample caps (2), plastic stoppers (2), 1.5V AA batteries (3), instrument quality certificate, and instruction manual.

CAL Check standards and testing reagents sold separately

**HI97725C** includes photometer, CAL Check standards, sample cuvettes (2), sample caps (2), plastic stoppers (2), 1.5V AA batteries (3), cuvette wiping cloth, CAL Check standard certificates, instrument quality certificate, instruction manual, and rigid carrying case.

Reagents sold separately

### Ordering Information

### Reagents and Standards

HI97725

**HI97701-11** CAL Check standard cuvettes for free and total chlorine

**HI93701-01** free chlorine reagents for 100 tests

**HI93701-03** free chlorine reagents for 300 tests

**HI97710-11** CAL Check standard cuvettes for pH

**HI93710-01** pH reagents for 100 tests

**HI93710-03** pH reagents for 300 tests

**HI93711-01** total chlorine reagents for 100 tests

**HI93711-03** total chlorine reagents for 300 tests

**HI97722-11** CAL Check standard cuvettes for cyanuric acid

**HI93722-01** cyanuric acid reagents for 100 tests

**HI93722-03** cyanuric acid reagents for 300 tests

HI97771

# Free Chlorine and Total Chlorine UHR Portable Photometer

- Advanced LED optical system
  - Innovative optical design that utilizes a reference detector and focusing lens to eliminate errors from changes in the light source and from imperfections in the glass cuvette.
  - LEDs have a much higher luminous efficiency, providing more light while using less power. They also produce little heat, which could otherwise affect electronic stability.
- CAL Check™
  - Validate instrument performance at any time using CAL Check cuvettes made with NIST traceable standards. The CAL Check screen guides the user step-by-step through the validation process and user calibration.
- On-screen tutorial mode with animations
  - Guides users step-by-step through the measurement process
- Waterproof and floating IP67 case
- Unit of measure is displayed along with reading
- Built-in timer
  - Built-in reaction timer that ensures consistency between tests.
- Error messages on display
  - Alerts to problems including no cap, high zero, and standard too low
- GLP data
  - Displays the last calibration date.
- Auto logging
- Battery status indicator
- Auto-shut off

## Significance of Use

As one of the most common forms of disinfectants used, chlorine improves water quality by destroying disease-producing microorganisms and by reacting with other organic and inorganic substances. Chlorine levels must be actively monitored to ensure sufficient chlorine is present for disinfection, as well as to control adverse effects such as taste, odor, and potential reactions with organic matter to form harmful disinfection byproducts.



**HI97771**  
Free Chlorine and Total Chlorine UHR

Specifications		HI97771 Free Chlorine and Total Chlorine UHR
Free Chlorine (powder and liquid)	Range	0.00 to 5.00 mg/L (as Cl <sub>2</sub> )
	Resolution	0.01 mg/L
	Accuracy @25°C (77°F)	±0.03 mg/L ±3% of reading at 25°C
	Method	Adaptation of the EPA DPD method 330.5
Total Chlorine Ultra High Range	Range	0 to 500 mg/L (as Cl <sub>2</sub> )
	Resolution	1 mg/L
	Accuracy @25°C (77°F)	±3 mg/L ±3% of reading at 25 °C
Measurement System	Method	adaptation of the Standard Methods for Examination of Water and Wastewater, 20th edition, 4500-Cl.
	Light Source	light emitting diode
	Bandpass filter	525 nm
	Bandpass filter bandwidth	8 nm
	Bandpass filter wavelength accuracy	±1.0 nm
	Light Detector	silicon photocell
Additional Specifications	Cuvette type	round 24.6 mm diameter (22 mm inside)
	Auto logging	50 readings
	Display	128 x 64 pixel B/W LCD with backlight
	Auto-off	after 15 minutes of inactivity (30 minutes before a READ measurement)
Battery type / Life	alkaline 1.5 V AA (3) / > 800 measurements (without backlight)	
Environment	0 to 50°C (32 to 122°F); 0 to 100% RH, non-serviceable	
Dimensions	142.5 x 102.5 x 50.5 mm (5.6 x 4.0 x 2.0")	
Weight	380 g (13.4 oz.)	

**HI97771** is supplied with sample cuvettes (2), sample caps (2), plastic stoppers (2), 1.5V AA batteries (3), instrument quality certificate, and instruction manual.

CAL Check standards and testing reagents sold separately

## Ordering Information

**HI97771C** includes photometer, CAL Check standards, sample cuvettes (2), sample caps (2), plastic stoppers (2), 1.5V AA batteries (3), cuvette wiping cloth, scissors, CAL Check standard certificate, instrument quality certificate, instruction manual, and HI7101412 rigid carrying case. Reagents sold separately

## Reagents and Standards

HI97771

<b>HI97701-11</b> CAL Check standard cuvettes for free and total chlorine
<b>HI93701-01</b> free chlorine powder reagent for 100 tests
<b>HI93701-03</b> free chlorine powder reagent for 300 tests
<b>HI93701-F</b> free chlorine liquid reagent for 300 tests
<b>HI97771-11</b> CAL Check standard cuvettes for total chlorine UHR
<b>HI95771-01</b> total chlorine UHR reagent for 100 tests
<b>HI95771-03</b> total chlorine UHR reagent for 300 tests

HI97736

# Total Hardness and pH Portable Photometer



- **Advanced LED optical system**
  - Innovative optical design that utilizes a reference detector and focusing lens to eliminate errors from changes in the light source and from imperfections in the glass cuvette.
  - LEDs have a much higher luminous efficiency, providing more light while using less power. They also produce little heat, which could otherwise affect electronic stability.
- **CAL Check™**
  - Validate instrument performance at any time using CAL Check cuvettes made with NIST traceable standards. The CAL Check screen guides the user step-by-step through the validation process and user calibration.
- **On-screen tutorial mode with animations**
  - Guides users step-by-step through the measurement process
- **Waterproof and floating IP67 case**
- **Unit of measure is displayed along with reading**
- **Built-in timer**
  - Built-in reaction timer that ensures consistency between tests.
- **Error messages on display**
  - Alerts to problems including no cap, high zero, and standard too low
- **GLP data**
  - Displays the last calibration date.
- **Auto logging**
- **Battery status indicator**
- **Auto-shut off**

## Specifications

## HI97736 Total Hardness and pH

Mg Hardness	Range	0.00 to 2.00 mg/L
	Resolution	0.01 mg/L
	Accuracy @25°C (77°F)	±0.11 mg/L ±5% of reading
	Method	adaptation of the Standard Methods for the Examination of Water and Wastewater, 18th ed. colorimetric method
Ca Hardness	Range	0.00 to 2.70 mg/L
	Resolution	0.01 mg/L
	Accuracy @25°C (77°F)	±0.11 mg/L ±5% of reading
	Method	adaptation of the Standard Methods for the Examination of Water and Wastewater, 18th ed. colorimetric method
Total Hardness	Range	0.00 to 4.70 mg/L (ppm)
	Resolution	0.01 mg/L
	Accuracy @25°C (77°F)	±0.11 mg/L ±5% of reading
	Method	adaptation of the Standard Methods for the Examination of Water and Wastewater, 18th ed. colorimetric method
pH	Range	6.5 to 8.5 pH
	Resolution	0.1 pH
	Accuracy @25°C (77°F)	±0.1 pH
	Method	adaptation of phenol red method
Measurement System	Light Source	light emitting diode
	Bandpass filter	525 nm
	Bandpass filter bandwidth	8 nm
	Bandpass filter wavelength accuracy	±1.0 nm
	Light Detector	silicon photocell
	Cuvette type	round 24.6 mm diameter (22 mm inside)
Additional Specifications	Auto logging	50 readings
	Display	128 x 64 pixel B/W LCD with backlight
	Auto-off	after 15 minutes of inactivity (30 minutes before a READ measurement)
	Battery type / Life	alkaline 1.5 V AA (3) / > 800 measurements (without backlight)
	Environment	0 to 50°C (32 to 122°F); 0 to 100% RH, non-serviceable
	Dimensions	142.5 x 102.5 x 50.5 mm (5.6 x 4.0 x 2.0")
	Weight	380 g (13.4 oz.)

**HI97736** is supplied with sample cuvettes (2), sample caps (2), plastic stoppers (2), 1.5V AA batteries (3), instrument quality certificate, and instruction manual.

CAL Check standards and testing reagents sold separately

## Ordering Information

**HI97736C** includes photometer, CAL Check standards, sample cuvettes (2), sample caps (2), plastic stoppers (2), 1.5V AA batteries (3), cuvette wiping cloth, CAL Check standard certificate, instrument quality certificate, instruction manual, and rigid carrying case.

Reagents sold separately

## Reagents and Standards

HI97736

**HI97710-11** CAL Check standard cuvettes for pH

**HI93710-01** pH reagents for 100 tests

**HI93710-03** pH reagents for 300 tests

**HI97719-11** CAL Check standard cuvettes for hardness

**HI93719-01** hardness reagents for 100 tests

**HI93719-03** hardness reagents for 300 tests



HI97710

## pH, Free and Total Chlorine Portable Photometer

The HI97710 meter measures free and total chlorine (Cl<sub>2</sub>) in water samples from 0.00 to 5.00 mg/L (ppm) and pH from 6.5 to 8.5. Chlorine is a widely used disinfectant. In order for chlorine to be effective the pH of the water should be less than pH 8.0.

- **Advanced LED optical system**
  - Innovative optical design that utilizes a reference detector and focusing lens to eliminate errors from changes in the light source and from imperfections in the glass cuvette.
  - LEDs have a much higher luminous efficiency, providing more light while using less power. They also produce little heat, which could otherwise affect electronic stability.
- **CAL Check™**
  - Validate instrument performance at any time using CAL Check cuvettes made with NIST traceable standards. The CAL Check screen guides the user step-by-step through the validation process and user calibration.
- **On-screen tutorial mode with animations**
  - Guides users step-by-step through the measurement process
- **Waterproof and floating IP67 case**
- **Unit of measure is displayed along with reading**
- **Built-in timer**
  - Built-in reaction timer that ensures consistency between tests.
- **Error messages on display**
  - Alerts to problems including no cap, high zero, and standard too low
- **GLP data**
  - Displays the last calibration date.
- **Auto logging**
- **Battery status indicator**
- **Auto-shut off**

Specifications		HI97710 pH and Free and Total Chlorine
pH	Range	6.5 to 8.5 pH
	Resolution	0.1 pH
	Accuracy @25°C (77°F)	±0.1 pH of reading at 25°C
	Method	adaptation of the Phenol Red method.
Chlorine Dioxide, Rapid Method	Range	0.00 to 2.00 mg/L (as ClO <sub>2</sub> )
	Resolution	0.01 mg/L
	Accuracy @25°C (77°F)	±0.10 mg/L, ±5% of reading
	Method	DPD-Glycine
Chlorine, Free and Total	Range (all methods)	0.00 to 5.00 mg/L (as Cl <sub>2</sub> )
	Resolution (all methods)	0.01 mg/L
	Accuracy @25°C (77°F) (all methods)	±0.03 mg/L ±3% of reading at 25°C
	Method	adaptation of the EPA DPD method 330.5
Measurement System	Light Source	light emitting diode
	Bandpass filter	525 nm
	Bandpass filter bandwidth	8 nm
	Bandpass filter wavelength accuracy	±1.0 nm
	Light Detector	silicon photocell
	Cuvette type	round 24.6 mm diameter (22 mm inside)
Additional Specifications	Auto logging	50 readings
	Display	128 x 64 pixel B/W LCD with backlight
	Auto-off	after 15 minutes of inactivity (30 minutes before a READ measurement)
	Battery type / Life	alkaline 1.5 V AA (3) / > 800 measurements (without backlight)
	Environment	0 to 50°C (32 to 122°F); 0 to 100% RH, non-serviceable
	Dimensions	142.5 x 102.5 x 50.5 mm (5.6 x 4.0 x 2.0")
	Weight	380 g (13.4 oz.)

**HI97710** is supplied with sample cuvettes (2), sample caps (2), plastic stoppers (2), 1.5V AA batteries (3), instrument quality certificate, and instruction manual.

CAL Check standards and testing reagents sold separately

### Ordering Information

**HI97710C** includes photometer, CAL Check standards, sample cuvettes (2), sample caps (2), plastic stoppers (2), 1.5V AA batteries (3), cuvette wiping cloth, scissors, CAL Check standard certificate, instrument quality certificate, instruction manual, and HI7101412 rigid carrying case.

Reagents sold separately

Reagents and Standards		HI97710
		<b>HI97701-11</b> CAL Check standard cuvettes for free and total chlorine
		<b>HI93701-01</b> free chlorine powder reagent for 100 tests
		<b>HI93701-03</b> free chlorine powder reagent for 300 tests
		<b>HI93701-F</b> free chlorine liquid reagent for 300 tests
		<b>HI93711-01</b> total chlorine powder reagent for 100 tests
		<b>HI93711-03</b> total chlorine powder reagent for 300 tests
		<b>HI93701-T</b> total chlorine liquid reagent for 300 tests
		<b>HI97710-11</b> CAL Check standard cuvettes for pH
		<b>HI93710-01</b> pH reagent for 100 tests
		<b>HI93710-03</b> pH reagent for 300 tests

HI97711

# Free and Total Chlorine Portable Photometer

- **Advanced LED optical system**
  - Innovative optical design that utilizes a reference detector and focusing lens to eliminate errors from changes in the light source and from imperfections in the glass cuvette.
  - LEDs have a much higher luminous efficiency, providing more light while using less power. They also produce little heat, which could otherwise affect electronic stability.
- **CAL Check™**
  - Validate instrument performance at any time using CAL Check cuvettes made with NIST traceable standards. The CAL Check screen guides the user step-by-step through the validation process and user calibration.
- **On-screen tutorial mode with animations**
  - Guides users step-by-step through the measurement process
- **Waterproof and floating IP67 case**
- **Unit of measure is displayed along with reading**
- **Built-in timer**
  - Built-in reaction timer that ensures consistency between tests.
- **Error messages on display**
  - Alerts to problems including no cap, high zero, and standard too low
- **GLP data**
  - Displays the last calibration date.
- **Auto logging**
- **Battery status indicator**
- **Auto-shut off**

## Significance of Use

As one of the most common forms of disinfectants used, chlorine improves water quality by destroying disease-producing microorganisms and by reacting with other organic and inorganic substances. Chlorine levels must be actively monitored to ensure sufficient chlorine is present for disinfection, as well as to control adverse effects such as taste, odor, and potential reactions with organic matter to form harmful disinfection byproducts.



Specifications		HI97711 Free and Total Chlorine
Measurement	Range (all methods)	0.00 to 5.00 mg/L (as Cl <sub>2</sub> )
	Resolution (all methods)	0.01 mg/L
	Accuracy @25°C (77°F) (all methods)	±0.03 mg/L ±3% of reading at 25 °C
	Method	adaptation of US EPA method 330.5, DPD Colorimetric method
Measurement System	Light Source	light emitting diode
	Bandpass filter	525 nm
	Bandpass filter bandwidth	8 nm
	Bandpass filter wavelength accuracy	±1.0 nm
Additional Specifications	Light Detector	silicon photocell
	Cuvette type	round 24.6 mm diameter (22 mm inside)
	Auto logging	50 readings
Additional Specifications	Display	128 x 64 pixel B/W LCD with backlight
	Auto-off	after 15 minutes of inactivity (30 minutes before a READ measurement)
	Battery type / Life	alkaline 1.5 V AA (3) / > 800 measurements (without backlight)
	Environment	0 to 50°C (32 to 122°F); 0 to 100% RH, non-serviceable
	Dimensions	142.5 x 102.5 x 50.5 mm (5.6 x 4.0 x 2.0")
	Weight	380 g (13.4 oz.)
Ordering Information	<b>HI97711</b> is supplied with sample cuvettes (2), sample caps (2), plastic stoppers (2), 1.5V AA batteries (3), instrument quality certificate, and instruction manual. <small>CAL Check standards and testing reagents sold separately</small>	
	<b>HI97711C</b> includes photometer, CAL Check standards, sample cuvettes (2), sample caps (2), plastic stoppers (2), 1.5V AA batteries (3), cuvette wiping cloth, scissors, CAL Check standard certificate, instrument quality certificate, instruction manual, and HI7101412 rigid carrying case. <small>Reagents sold separately</small>	
Reagents and Standards	HI97711	<b>HI97701-11</b> CAL Check standard cuvettes for free and total chlorine
		<b>HI93701-01</b> free chlorine powder reagent for 100 tests
		<b>HI93701-03</b> free chlorine powder reagent for 300 tests
		<b>HI93701-F</b> free chlorine liquid reagent for 300 tests
		<b>HI93711-01</b> total chlorine powder reagent for 100 tests
		<b>HI93711-03</b> total chlorine powder reagent for 300 tests
		<b>HI93701-T</b> total chlorine liquid reagent for 300 tests

HI97734

# Free and Total Chlorine HR Portable Photometer



- **Advanced LED optical system**
  - Innovative optical design that utilizes a reference detector and focusing lens to eliminate errors from changes in the light source and from imperfections in the glass cuvette.
  - LEDs have a much higher luminous efficiency, providing more light while using less power. They also produce little heat, which could otherwise affect electronic stability.
- **CAL Check™**
  - Validate instrument performance at any time using CAL Check cuvettes made with NIST traceable standards. The CAL Check screen guides the user step-by-step through the validation process and user calibration.
- **On-screen tutorial mode with animations**
  - Guides users step-by-step through the measurement process
- **Waterproof and floating IP67 case**
- **Unit of measure is displayed along with reading**
- **Built-in timer**
  - Built-in reaction timer that ensures consistency between tests.
- **Error messages on display**
  - Alerts to problems including no cap, high zero, and standard too low
- **GLP data**
  - Displays the last calibration date.
- **Auto logging**
- **Battery status indicator**
- **Auto-shut off**

## Significance of Use

Chlorine is one of the most cost-effective disinfectants used in a variety of different applications. Its use varies from light application in surface sanitation, to heavy duty disinfection of medical devices, to removal of microorganism infections in piping systems. The advantage of using chlorine over peroxide-type disinfectants is that chlorine is not only a strong oxidant, it also is capable of breaking tough chemical bonds found in cell walls or biofilms. Correct and effective use of chlorine helps to destroy disease-causing pathogens, reduce odors, and eliminate bacteria.

Specifications		HI97734 Free and Total Chlorine HR
Chlorine	Range (all methods)	0.00 to 10.00 mg/L (as Cl <sub>2</sub> )
	Resolution (all methods)	0.01 mg/L
	Accuracy @25°C (77°F) (all methods)	±0.03 mg/L ±3% of reading at 25 °C
	Method	Adaptation of EPA DPD method 330.5
Measurement System	Light Source	light emitting diode
	Bandpass filter	525 nm
	Bandpass filter bandwidth	8 nm
	Bandpass filter wavelength accuracy	±1.0 nm
	Light Detector	silicon photocell
Additional Specifications	Cuvette type	round 24.6 mm diameter (22 mm inside)
	Auto logging	50 readings
	Display	128 x 64 pixel B/W LCD with backlight
	Auto-off	after 15 minutes of inactivity (30 minutes before a READ measurement)
	Battery type / Life	alkaline 1.5 V AA (3) / > 800 measurements (without backlight)
	Environment	0 to 50°C (32 to 122°F); 0 to 100% RH, non-serviceable
	Dimensions	142.5 x 102.5 x 50.5 mm (5.6 x 4.0 x 2.0")
Weight	380 g (13.4 oz.)	
Ordering Information	<p><b>HI97734</b> is supplied with sample cuvettes (2), sample caps (2), plastic stoppers (2), 1.5V AA batteries (3), instrument quality certificate, and instruction manual.  <small>CAL Check standards and testing reagents sold separately</small></p> <p><b>HI97734C</b> includes photometer, CAL Check standards, sample cuvettes (2), sample caps (2), plastic stoppers (2), 1.5V AA batteries (3), cuvette wiping cloth, scissors, CAL Check standard certificates, instrument quality certificate, instruction manual, and HI7101412 rigid carrying case.  <small>Reagents sold separately</small></p>	
	Reagents and Standards	<p>HI97734</p> <p><b>HI97734-11</b> CAL Check standard cuvettes for free and total chlorine HR</p> <p><b>HI93734-01</b> free and total chlorine HR reagent for 100 tests</p> <p><b>HI93734-03</b> free and total chlorine HR reagent for 300 tests</p>



HI97741

## Total Hardness and Iron, Low Range Portable Photometer

- **Advanced LED optical system**
  - Innovative optical design that utilizes a reference detector and focusing lens to eliminate errors from changes in the light source and from imperfections in the glass cuvette.
  - LEDs have a much higher luminous efficiency, providing more light while using less power. They also produce little heat, which could otherwise affect electronic stability.
- **CAL Check™**
  - Validate instrument performance at any time using CAL Check cuvettes made with NIST traceable standards. The CAL Check screen guides the user step-by-step through the validation process and user calibration.
- **On-screen tutorial mode with animations**
  - Guides users step-by-step through the measurement process
- **Waterproof and floating IP67 case**
- **Unit of measure is displayed along with reading**
- **Built-in timer**
  - Built-in reaction timer that ensures consistency between tests.
- **Error messages on display**
  - Alerts to problems including no cap, high zero, and standard too low

- **GLP data**
  - Displays the last calibration date.
- **Auto logging**
- **Battery status indicator**
- **Auto-shut off**

### Significance of Use

In domestic water, iron can alter taste, making it unpleasant to drink. It can also stain laundry, damage kitchenware and favor the growth of certain bacteria. However, low levels of iron are critical in beverage production. The iron concentration in water needs to be monitored since it can become harmful above certain levels.

Hardness, on the other hand, is indicative of the presence of calcium and magnesium in water. By passing through various layers of soil and rocks, rain water dissolves some of the mineral substances.

Hardness can cause pipe rusting in water heating and cooling systems, reverse osmosis and demineralization plants. It can also increase the consumption of soaps and detergents in industrial washing machines or laundries.



## Specifications

## HI97741 Total Hardness and Iron, LR

Mg Hardness	Range	0.00 to 2.00 mg/L (as CaCO <sub>3</sub> )
	Resolution	0.01 mg/L
	Accuracy @25°C (77°F)	±0.11 mg/L ±5% of reading
	Method	adaptation of the Standard Methods for the Examination of Water and Wastewater, 18th ed. colorimetric method
Ca Hardness	Range	0.00 to 2.70 mg/L (as CaCO <sub>3</sub> )
	Resolution	0.01 mg/L
	Accuracy @25°C (77°F)	±0.11 mg/L ±5% of reading
	Method	adaptation of the Standard Methods for the Examination of Water and Wastewater, 18th ed. colorimetric method
Total Hardness	Range	0.00 to 4.70 mg/L (as CaCO <sub>3</sub> )
	Resolution	0.01 mg/L
	Accuracy @25°C (77°F)	±0.11 mg/L ±5% of reading
	Method	adaptation of the Standard Methods for the Examination of Water and Wastewater, 18th ed. colorimetric method
Iron, LR	Range	0 to 1.60 mg/L (as Fe)
	Resolution	0.01 mg/L
	Accuracy @25°C (77°F)	±0.01 mg/L ±8% of reading
	Method	Adaptation of the TPTZ method.
Measurement System	Light Source	light emitting diode
	Bandpass filter	525 nm
	Bandpass filter bandwidth	8 nm
	Bandpass filter wavelength accuracy	±1.0 nm
	Light Detector	silicon photocell
	Cuvette type	round 24.6 mm diameter (22 mm inside)
Additional Specifications	Auto logging	50 readings
	Display	128 x 64 pixel B/W LCD with backlight
	Auto-off	after 15 minutes of inactivity (30 minutes before a READ measurement)
	Battery type / Life	alkaline 1.5 V AA (3) / > 800 measurements (without backlight)
	Environment	0 to 50°C (32 to 122°F); 0 to 100% RH, non-serviceable
	Dimensions	142.5 x 102.5 x 50.5 mm (5.6 x 4.0 x 2.0")
	Weight	380 g (13.4 oz.)

**HI97741** is supplied with sample cuvettes (2), sample caps (2), plastic stoppers (2), 1.5V AA batteries (3), instrument quality certificate, and instruction manual.

CAL Check standards and testing reagents sold separately

## Ordering Information

**HI97741C** includes photometer, CAL Check standards, sample cuvettes (2), sample caps (2), plastic stoppers (2), 1.5V AA batteries (3), scissors, cuvette wiping cloth, CAL Check standard certificate, instrument quality certificate, instruction manual, and rigid carrying case.

Reagents sold separately

Reagents and Standards	HI97741	<b>HI97719-11</b> CAL Check standard cuvettes for hardness
		<b>HI93719-01</b> hardness reagents for 100 tests
		<b>HI93719-03</b> hardness reagents for 300 tests
		<b>HI97746-11</b> CAL Check standard cuvettes for iron
		<b>HI93746-01</b> iron reagents for 50 tests
		<b>HI93746-03</b> iron reagents for 150 tests

HI97742

# Iron Low Range and Manganese Low Range Portable Photometer

- **Advanced LED optical system**
  - Innovative optical design that utilizes a reference detector and focusing lens to eliminate errors from changes in the light source and from imperfections in the glass cuvette.
  - LEDs have a much higher luminous efficiency, providing more light while using less power. They also produce little heat, which could otherwise affect electronic stability.
- **CAL Check™**
  - Validate instrument performance at any time using CAL Check cuvettes made with NIST traceable standards. The CAL Check screen guides the user step-by-step through the validation process and user calibration.
- **On-screen tutorial mode with animations**
  - Guides users step-by-step through the measurement process
- **Waterproof and floating IP67 case**
- **Unit of measure is displayed along with reading**
- **Built-in timer**
  - Built-in reaction timer that ensures consistency between tests.
- **Error messages on display**
  - Alerts to problems including no cap, high zero, and standard too low
- **GLP data**
  - Displays the last calibration date.
- **Auto logging**
- **Battery status indicator**
- **Auto-shut off**



Specifications	HI97742	
Iron LR	Range	0.00 to 1.60 mg/L (ppm)
	Resolution	0.01 mg/L
	Accuracy @25°C (77°F)	±0.01 mg/L ±8% or reading
	Method	adaptation of the TPTZ method
Manganese LR	Range	0 to 300 µg/L (as Mn)
	Resolution	0.01 µg/L
	Accuracy @25°C (77°F)	±10 µg/L ±3% of reading at 25°C
	Method	adaptation of the 1-(2-pyridylazo)-2-nphtol PAN method
Measurement System	Light Source	light emitting diode
	Bandpass filter	575 nm
	Bandpass filter bandwidth	8 nm
	Bandpass filter wavelength accuracy	±1.0 nm
	Light Detector	silicon photocell
	Cuvette type	round 24.6 mm diameter (22 mm inside)
Additional Specifications	Auto logging	50 readings
	Display	128 x 64 pixel B/W LCD with backlight
	Auto-off	after 15 minutes of inactivity (30 minutes before a READ measurement)
	Battery type / Life	alkaline 1.5 V AA (3) / > 800 measurements (without backlight)
	Environment	0 to 50°C (32 to 122°F); 0 to 100% RH, non-serviceable
Dimensions	142.5 x 102.5 x 50.5 mm (5.6 x 4.0 x 2.0")	
Weight	380 g (13.4 oz.)	

**HI97742** is supplied with sample cuvettes (2), sample caps (2), plastic stoppers (2), 1.5V AA batteries (3), instrument quality certificate, and instruction manual.

CAL Check standards and testing reagents sold separately

## Ordering Information

**HI97742C** includes photometer, CAL Check standards, sample cuvettes (2), sample caps (2), plastic stoppers (2), 1.5V AA batteries (3), scissors, cuvette wiping cloth, CAL Check standard certificate, instrument quality certificate, instruction manual, and rigid carrying case.

Reagents sold separately

Reagents and Standards	HI97742	
		<b>HI97742-11</b> CAL Check standard cuvettes for iron LR
		<b>HI93746-01</b> iron LR reagents for 50 tests
		<b>HI93746-03</b> iron LR reagents for 150 tests
		<b>HI97748-11</b> CAL Check standard cuvettes for manganese LR
		<b>HI93748-01</b> manganese LR reagents for 50 tests
		<b>HI93748-03</b> manganese LR reagents for 150 tests

HI97752

# Calcium and Magnesium Portable Photometer



- Advanced LED optical system
  - Innovative optical design that utilizes a reference detector and focusing lens to eliminate errors from changes in the light source and from imperfections in the glass cuvette.
  - LEDs have a much higher luminous efficiency, providing more light while using less power. They also produce little heat, which could otherwise affect electronic stability.
- CAL Check™
  - Validate instrument performance at any time using CAL Check cuvettes made with NIST traceable standards. The CAL Check screen guides the user step-by-step through the validation process and user calibration.
- On-screen tutorial mode with animations
  - Guides users step-by-step through the measurement process
- Waterproof and floating IP67 case
- Unit of measure is displayed along with reading
- Built-in timer
  - Built-in reaction timer that ensures consistency between tests.
- Error messages on display
  - Alerts to problems including no cap, high zero, and standard too low
- GLP data
  - Displays the last calibration date.
- Auto logging
- Battery status indicator
- Auto-shut off

## Specifications

## HI97752 Calcium and Magnesium

Calcium	Range	0 to 400 mg/L (ppm) (as Ca <sup>2+</sup> )
	Resolution	1 mg/L
	Accuracy @25°C (77°F)	±10 mg/L ±5% of reading
	Method	adaptation of oxalate method
Magnesium	Range	0 to 150 mg/L (ppm) (as Mg <sup>2+</sup> )
	Resolution	1 mg/L
	Accuracy @25°C (77°F)	±5 mg/L ±3% of reading
Measurement System	Method	adaptation of the calmagite method
	Light Source	light emitting diode
	Bandpass filter	466 nm
	Bandpass filter bandwidth	8 nm
	Bandpass filter wavelength accuracy	±1.0 nm
	Light Detector	silicon photocell
	Cuvette type	round 24.6 mm diameter (22 mm inside)
Additional Specifications	Auto logging	50 readings
	Display	128 x 64 pixel B/W LCD with backlight
	Auto-off	after 15 minutes of inactivity (30 minutes before a READ measurement)
	Battery type / Life	alkaline 1.5 V AA (3) / > 800 measurements (without backlight)
	Environment	0 to 50°C (32 to 122°F); 0 to 100% RH, non-serviceable
	Dimensions	142.5 x 102.5 x 50.5 mm (5.6 x 4.0 x 2.0")
	Weight	380 g (13.4 oz.)

HI97752 is supplied with sample cuvettes (2), sample caps (2), plastic stoppers (2), 1.5V AA batteries (3), instrument quality certificate, and instruction manual.

CAL Check standards and testing reagents sold separately

## Ordering Information

HI97752C includes photometer, CAL Check standards, sample cuvettes (2), sample caps (2), plastic stoppers (2), 1.5V AA batteries (3), cuvette wiping cloth, CAL Check standard certificate, instrument quality certificate, instruction manual, and rigid carrying case.

Reagents sold separately

## Reagents and Standards

HI97752

HI93752-01 calcium and magnesium reagents for 100 Tests (50 each)

HI93752-03 calcium and magnesium reagents for 300 Tests (150 each)

HI97754-11 CAL Check standard cuvettes for magnesium

HI937520-01 magnesium reagents for 50 tests

HI937520-03 magnesium reagents for 150 tests

HI97752-11 CAL Check standard cuvettes for calcium

HI937521-01 calcium reagents for 50 tests

HI937521-03 calcium reagents for 150 tests

## Significance of Use

Calcium and magnesium both play important roles in the growth of plants. Calcium helps plant roots develop and increases the resistance and strength of plant tissues and stems. Magnesium is an indispensable mineral that helps in the production of chlorophyll, the light-absorbing green pigment that serves as an energy source for plants. It also increases vitamin concentrations and aids in uptake of phosphorus within the plant body.



HI97745

## Free and Total Chlorine, Hardness, Iron Low Range, and pH Portable Photometer

- **Advanced LED optical system**
  - Innovative optical design that utilizes a reference detector and focusing lens to eliminate errors from changes in the light source and from imperfections in the glass cuvette.
  - LEDs have a much higher luminous efficiency, providing more light while using less power. They also produce little heat, which could otherwise affect electronic stability.
- **CAL Check™**
  - Validate instrument performance at any time using CAL Check cuvettes made with NIST traceable standards. The CAL Check screen guides the user step-by-step through the validation process and user calibration.
- **On-screen tutorial mode with animations**
  - Guides users step-by-step through the measurement process
- **Waterproof and floating IP67 case**
- **Unit of measure is displayed along with reading**
- **Built-in timer**
  - Built-in reaction timer that ensures consistency between tests.
- **Error messages on display**
  - Alerts to problems including no cap, high zero, and standard too low
- **GLP data**
  - Displays the last calibration date.
- **Auto logging**
- **Battery status indicator**
- **Auto-shut off**

### Significance of Use

Chlorine and pH are two of the most closely monitored parameters in water quality tests. Hardness is also an important parameter, attentively regulated to reduce waste or ensure proper functioning of equipment. Iron can cause an unpleasant taste or stain kitchenware or laundry.

## Specifications

## HI97745 Free and Total chlorine, Total Hardness, Iron Low Range and pH

pH	Range	6.5 to 8.5 pH
	Resolution	0.1 pH
	Accuracy @25°C (77°F)	±0.1 pH
	Method	adaptation of the phenol red method
Chlorine, Free Chlorine, Total	Range	0.00 to 5.00 mg/L (ppm) (as Cl <sub>2</sub> )
	Resolution	0.01 mg/L
	Accuracy @25°C (77°F)	±0.03 mg/L ±3% of reading
	Method	adaptation of the USEPA method and Standard Method 4500-Cl <sub>G</sub> method
Total Hardness	Range	0.00 to 4.70 mg/L (ppm) (as CaCO <sub>3</sub> )
	Resolution	0.01 mg/L
	Accuracy @25°C (77°F)	±0.11 mg/L ±5% of reading
	Method	adaptation of the Standard Methods for the examination of Water and Wastewater, 18th ed., calmagite colorimetric method
Iron, Low Range	Range	0 to 1.60 mg/L (ppm) (as Fe)
	Resolution	0.01 mg/L
	Accuracy @25°C (77°F)	±0.01 mg/L ±8% of reading
	Method	adaptation of the TPTZ method method
Measurement System	Light Source	light emitting diode
	Bandpass filter	525 nm
	Bandpass filter bandwidth	8 nm
	Bandpass filter wavelength accuracy	±1.0 nm
	Light Detector	silicon photocell
	Cuvette type	round 24.6 mm diameter (22 mm inside)
Additional Specifications	Auto logging	50 readings
	Display	128 x 64 pixel B/W LCD with backlight
	Auto-off	after 15 minutes of inactivity (30 minutes before a READ measurement)
	Battery type / Life	alkaline 1.5 V AA (3) / > 800 measurements (without backlight)
	Environment	0 to 50°C (32 to 122°F); 0 to 100% RH, non-serviceable
	Dimensions	142.5 x 102.5 x 50.5 mm (5.6 x 4.0 x 2.0")
	Weight	380 g (13.4 oz.)

## Ordering Information

**HI97745** is supplied with sample cuvettes (2), sample caps (2), plastic stoppers (2), 1.5V AA batteries (3), instrument quality certificate, and instruction manual.

CAL Check standards and testing reagents sold separately

**HI97745C** includes photometer, CAL Check standards, sample cuvettes (2), sample caps (2), plastic stoppers (2), 1.5V AA batteries (3), scissors, cuvette wiping cloth, CAL Check standard certificate, instrument quality certificate, instruction manual, and rigid carrying case.

Reagents sold separately

## Reagents and Standards

HI97745	<b>HI97701-11</b> CAL Check standard cuvettes for free and total chlorine
	<b>HI93701-01</b> free chlorine reagents for 100 tests
	<b>HI93701-03</b> free chlorine reagents for 300 tests
	<b>HI97710-11</b> CAL Check standard cuvettes for pH
	<b>HI93710-01</b> pH reagents for 100 tests
	<b>HI93710-03</b> pH reagents for 300 tests
	<b>HI93711-01</b> total chlorine reagents for 100 tests
	<b>HI93711-03</b> total chlorine reagents for 300 tests
	<b>HI97719-11</b> CAL Check standard cuvettes for hardness
	<b>HI93719-01</b> total hardness reagents for 100 tests
	<b>HI93719-03</b> total hardness reagents for 300 tests
	<b>HI97746-11</b> CAL Check standard cuvettes for iron
	<b>HI93746-01</b> iron reagents for 50 tests
	<b>HI93746-03</b> iron reagents for 150 tests

HI96785

# Honey Color Portable Analyzer



- Auto-shut off
  - Automatic shut off after 10 minutes of non-use when the meter is in measurement mode. Prevents wastage of batteries in the event the meter is accidentally left on.
- Battery status indicator

The HI96785 portable microprocessor analyzer measures the percent light transmittance of honey compared to analytical reagent grade glycerol. The transmittance value allows identification of the honey Pfund grade. The instrument directly displays the measurement result expressed in mm Pfund.

Measurements are made using matched square optical cuvettes having a 10 mm light path.

Display codes aid the user in routine operations.

The meters have an auto-shut off feature that will turn the instrument off after 10 minutes of non-use.



## Specifications

## HI96785

Range	0 to 150 mm Pfund
Resolution	1 mm Pfund
Accuracy @25°C (77°F)	±2 mm Pfund @ 80mm Pfund
Light Source	tungsten lamps
Light Detector	silicon photocell with narrow band interference filter @ 420 nm and 525 nm
Method	direct measurement
Environment	0 to 50°C (32 to 122°F); RH max 95% non-condensing
Battery Type	9V (1 pc.)
Auto-Shut Off	after ten minutes of non-use in measurement mode; after one hour of non-use in calibration mode; with last reading reminder
Dimensions	192 x 104 x 69 mm (7.6 x 4.1 x 2.7")
Weight	320g (11.3 oz.)
<b>Ordering Information</b>	<b>HI96785</b> is supplied with sample cuvettes (5), light shield cap, 30 mL Glycerol (1 bottle), 9V battery, instruction manual, and quick reference guide.
<b>Accessories</b>	<b>HI93703-57</b> Glycerol, 30 mL (4pcs.)
	<b>HI93703-56</b> honey color analysis kit contains 100 square cuvettes, 1 x 30 mL of glycerol (bottle), and 2 x 5 mL syringe (average of 90 tests)
	<b>HI740226</b> 5 mL graduated syringe

## Significance of Use

Honey color varies naturally in a wide range of tonalities, ranging from light yellow to amber, dark amber and black in extreme cases; sometimes green or red hues may also occur.

Color of untreated honey depends on botanical origin: for this reason color is very important for definition and commercial classification of monofloral honeys. Honey darkens with ageing, and other changes in color may result from beekeeper's interventions and from the different ways of conservation (e.g.: use of old honeycombs, contact with metals, high temperatures, exposition to light, etc.).

The primary characteristic for commercial honey classification is color. Color classes are expressed in millimeters (mm) Pfund grades, compared to an analytical grade Glycerol Standard Reference. **Table 1** reports the USDA classification for honey samples and the related mm Pfund values.

**Table 2** shows the color of different monofloral honeys: data are obtained from a statistical set of honey samples. The table reports for each type of honey: average value of color, standard deviation, and the minimum and maximum values measured.

### Table 1

USDA Color Standards Designations	Color Range Pfund Scales (mm)
Water White	8 or less
Extra White	Over 8 to and including 17
White	Over 17 to and including 34
Extra Light Amber	Over 34 to and including 50
Light Amber	Over 50 to and including 85
Amber	Over 85 to and including 114
Dark Amber	Over 114

### Table 2

Honey Type common name	Latin name	AVERAGE (mm Pfund)	SD (mm fund)	Min. Value (mm Pfund)	Max. Value (mm Pfund)
Acacia tree	Robinia pseudoacacia	15	6	11	27
Chestnut tree	Castanea sativa	92	19	62	119
Citrus spp.	Citrus spp.	14	5	11	35
Dandelion	Taraxacum officinalis	54	11	41	71
Eucalyptus	Eucalyptus spp.	58	11	41	71
Fir honeydew		98	8	83	110
Fir tree honeydew		99	16	83	130
French honeysuckle	Hedysarium coronarium	18	6	11	35
Heather	Erica arborea	96	10	83	119
Lime tree	Tillia spp.	43	17	11	71
Rhododendron	Rhododendron spp.	13	5	11	27
Strawberry tree	Arbutus unedo	70	10	55	83
Sunflower	Heliantus annus	61	6	51	71
Thyme	Thymus spp.	52	16	27	83

Test	Reagent Kit	No. of Tests
Alkalinity	HI93755-01	100
	HI93755-03	300
Alkalinity, Marine	HI772-26	25
Aluminum	HI93712-01	100
	HI93712-03	300
Ammonia HR	HI93733-01	100
	HI93733-03	300
Ammonia MR	HI93715-01	100
	HI93715-03	300
Ammonia LR	HI93700-01	100
	HI93700-03	300
Bromine	HI93716-01	100
	HI93716-03	300
Calcium	HI937521-01	50
	HI937521-03	150
Calcium, Marine	HI758-26	25
	HI758U-26 (USA)	25
Calcium and Magnesium	HI93752-01	100 (50 each)
	HI93752-03	300 (150 each)
Chloride	HI93753-01	100
	HI93753-03	300
Chlorine Dioxide	HI93738-01	100
	HI93738-03	300
Chlorine Dioxide, Rapid Method	HI96779-01	100
	HI96779-03	300
Chlorine UHR	HI95771-01	100
	HI95771-03	300
Chlorine, Free	HI93701-01	100
	HI93701-03	300
	HI93701-F (liquid)	300
Chlorine, Free and Total HR	HI93734-01	100
	HI93734-03	300
Chlorine, Free ULR	HI95762-01	100
	HI95762-03	300
Chlorine, Total	HI93711-01	100
	HI93711-03	300
	HI93701-T (liquid)	300
Chlorine, Total ULR	HI95761-01	100
	HI95761-03	300
Chromium VI HR	HI93723-01	100
	HI93723-03	300
Chromium VI LR	HI93749-01	100
	HI93749-03	300
Chromium, Total and VI (16 mm vial)	HI96781-25	25
COD UHR (16 mm vial)	HI93754J-25	24
	HI93702-01	100
	HI93702-03	300
	HI93702T-01 (total)	100
Copper HR	HI93702T-03 (total)	300
	HI95747-01	100
Copper LR	HI95747-03	300
	HI93714-01	100
Cyanide	HI93714-03	300
	HI93722-01	100
Cyanuric Acid	HI93722-03	300
	HI95769-01	40
Dispersing Reagent (to remove turbidity interference when testing for Manganese, Nickel, or Silver,	HI93703-51	20 mL bottle
Fluoride HR	HI93739-01	100
	HI93739-03	300
Fluoride LR	HI93729-01	100
	HI93729-03	300
Glycine Powder (for removing chlorine interference when testing for ozone)	HI93703-52	100
Hardness, Calcium	HI93720-01	100
	HI93720-03	300
Hardness (Magnesium) and Total Hardness	HI93719-01	100
	HI93719-03	300

Test	Reagent Kit	No. of Tests
Hardness, Total HR	HI93735-02	100
	HI93735-01	100
	HI93735-00	100
	HI93735-0	100 ea. (300)
Hardness, Total MR	HI93704-01	100
	HI93704-03	300
Hardness, Total LR	HI93718-01	100
	HI93718-03	300
Hardness, Total LR+MR+HR	HI96776-01	100
	HI96776-03	300
Hydrazine	HI96777-01	100
Iodine	HI93721-01	100
	HI93721-03	300
Iron (II) (ferrous)	HI93746-01	50
	HI93746-03	150
Iron (II)/(III) (ferrous and ferric)	HI96777-01	100
	HI96777-03	300
Iron HR	HI93721-01	100
	HI93721-03	300
Iron LR	HI93746-01	50
	HI93746-03	150
Iron, Total (16 mm vial)	HI96778-25	25
Manganese HR	HI93709-01	100
	HI93709-03	300
Manganese LR	HI93748-01	50
	HI93748-03	150
Magnesium	HI937520-01	50
	HI937520-03	150
Molybdenum	HI93730-01	100
	HI93730-03	300
Nickel HR	HI93726-01	100
	HI93726-03	300
Nickel LR	HI93740-01	50
	HI93740-03	150
Nitrate	HI93728-01	100
	HI93728-03	300
Nitrate HR, Marine	HI782-25	25
Nitrate LR, Marine	HI781-25	25
Nitrite HR	HI93708-01	100
	HI93708-03	300
Nitrite LR	HI93707-01	100
	HI93707-03	300
Nitrite ULR, Marine	HI764-25	25
Nitrite LR (16 mm vial)	HI96783-25	25
Nitrite MR (16 mm vial)	HI96784-25	25
Oxygen, Dissolved (DO)	HI93732-01	100
	HI93732-03	300
Ozone	HI93757-01	100
	HI93757-03	300
pH	HI93710-01	100
	HI93710-03	300
pH, Marine	HI780-25	100
Phosphate HR	HI93717-01	100
	HI93717-03	300
Phosphate LR	HI93713-01	100
	HI93713-03	300
Phosphate ULR, Marine	HI774-25	25
Phosphorus	HI93706-01	100
	HI93706-03	300
Potassium	HI93750-01	100
	HI93750-03	300
Silica HR	HI96770-01	100
	HI96770-03	300
Silica LR	HI93705-01	100
	HI93705-03	300
Silver	HI93737-01	50
	HI93737-03	150
Sulfate	HI93751-01	100
	HI93751-03	300
Surfactants, Anionic (16 mm vial)	HI96782-25	25
	HI95769-01	40
Surfactants, Non Anionic (16 mm vial)	HI96780-25	24
Zinc	HI93731-01	100
	HI93731-03	300



# CAL Check™ Kits

## Single Parameter

Instrument	CAL Check Standards Set	Parameter
HI97700	<b>HI97700-11</b>	Ammonia LR
HI97701	<b>HI97701-11</b>	Free/Total Chlorine
HI97702	<b>HI97702-11</b>	Copper HR
HI97704	<b>HI97704-11</b>	Hydrazine
HI97705	<b>HI97705-11</b>	Silica LR
HI97706	<b>HI97706-11</b>	Phosphorus
HI97707	<b>HI97707-11</b>	Nitrite LR
HI97708	<b>HI97708-11</b>	Nitrite HR
HI97709	<b>HI97709-11</b>	Manganese HR
HI97712	<b>HI97712-11</b>	Aluminum
HI97713	<b>HI97713-11</b>	Phosphate, Low Range
HI97714	<b>HI97714-11</b>	Cyanide
HI97715	<b>HI97715-11</b>	Ammonia MR
HI97716	<b>HI97716-11</b>	Bromine
HI97717	<b>HI97717-11</b>	Phosphate, High Range
HI97718	<b>HI97718-11</b>	Iodine
HI97719	<b>HI97719-11</b>	Mg Hardness
HI97720	<b>HI97720-11</b>	Ca Hardness
HI97721	<b>HI97721-11</b>	Iron HR
HI97722	<b>HI97722-11</b>	Cyanuric Acid
HI97723	<b>HI97723-11</b>	Chromium VI HR
HI97726	<b>HI97726-11</b>	Nickel HR
HI97727	<b>HI97727-11</b>	Color of Water
HI97728	<b>HI97728-11</b>	Nitrate
HI97729	<b>HI97729-11</b>	Fluoride LR
HI97730	<b>HI97730-11</b>	Molybdenum
HI97731	<b>HI97731-11</b>	Zinc
HI97732	<b>HI97732-11</b>	Oxygen, Dissolved
HI97733	<b>HI97733-11</b>	Ammonia HR
HI97735	<b>HI97735-11</b>	Total Hardness
HI97737	<b>HI97737-11</b>	Silver
HI97738	<b>HI97738-11</b>	Chlorine Dioxide
HI97739	<b>HI97739-11</b>	Fluoride HR
HI97740	<b>HI97740-11</b>	Nickel LR
HI97742	<b>HI97742-11</b>	Iron LR
HI97746	<b>HI97746-11</b>	Iron LR
HI97747	<b>HI97747-11</b>	Copper LR
HI97748	<b>HI97748-11</b>	Manganese LR
HI97749	<b>HI97749-11</b>	Chromium VI LR
HI97750	<b>HI97750-11</b>	Potassium
HI97751	<b>HI97751-11</b>	Sulfate
HI97753	<b>HI97753-11</b>	Chloride
HI97761	<b>HI97761-11</b>	Total Chlorine ULR
HI97762	<b>HI97762-11</b>	Free Chlorine, ULR
HI97769	<b>HI97769-11</b>	Anionic Surfactants
HI97770	<b>HI97770-11</b>	Silica HR
HI97779	<b>HI97779-11</b>	Chlorine Dioxide (Rapid)

## Multiparameter

Instrument	CAL Check Standards Set	Parameter
HI97101	<b>HI97701-11</b> <b>HI97710-11</b> <b>HI97716-11</b> <b>HI97718-11</b> <b>HI97722-11</b> <b>HI97746-11</b>	Free and total Chlorine pH Bromine Iodine Cyanuric Acid Iron LR
HI97104 / HI971044	<b>HI97775-11</b> <b>HI97722-11</b> <b>HI97701-11</b> <b>HI97710-11</b>	Alkalinity Cyanuric Acid Free/Total Chlorine pH
HI97105	<b>HI97105-11</b>	Marine pH Marine Alkalinity Marine Calcium Marine Nitrate LR Marine Nitrate HR Marine Nitrite ULR Marine Phosphate ULR
HI97710	<b>HI97701-11</b> <b>HI97710-11</b>	Free/Total Chlorine pH
HI97725	<b>HI97701-11</b> <b>HI97722-11</b> <b>HI97710-11</b>	Free and Total Chlorine Cyanuric Acid pH
HI97711	<b>HI97701-11</b>	Free/Total Chlorine
HI97734	<b>HI97734-11</b>	Free/Total Chlorine, HR
HI97736	<b>HI97710-11</b> <b>HI97719-11</b>	pH hardness
HI97741	<b>HI97719-11</b> <b>HI97746-11</b>	Total Hardness Iron LR
HI97742	<b>HI97742-11</b> <b>HI97748-11</b>	Iron LR Manganese LR
HI97745	<b>HI97701-11</b> <b>HI97710-11</b> <b>HI97719-11</b> <b>HI97746-11</b>	Free and Total Chlorine pH Total Hardness Iron LR
HI97752	<b>HI97752-11</b> <b>HI97754-11</b>	Calcium Magnesium
HI97771	<b>HI97701-11</b>	Free/Total Chlorine, UHR

\*Each CAL Check cuvette is clearly labeled with its respective measurement. Please read the full instruction manual before validation/calibration.

HI83746

## Photometer for the Determination of Concentration of Reducing Sugars

- **Built-in timer**
  - Display of time remaining before a measurement is taken. Ensures that all readings are taken at the appropriate reaction intervals for the test being performed.
- **Zero key**
  - A simple press of the zero key on the face of the meter will account for the color and imperfections in the oil sample before reagent addition.
- **GLP**
  - Review of the last calibration date.
- **Auto shut-off**
  - Automatic shut-off after 15 minutes of non-use when the meter is in measurement mode. Prevents wastage of batteries in the event the meter is accidentally left on.
- **Battery status indicator**
  - Indicates the amount of battery life left.
- **Error messages**
  - Messages on display alerting to problems including no cap, high zero, and standard too low.
- **Units of measure**
  - Appropriate unit of measure is displayed along with reading.

The HI83746 photometer is for the determination of reducing sugars in wine. Hanna's photometers feature an advanced optical system; the combination of a special tungsten lamp, a narrow band interference filter, and silicon photodetector ensure accurate photometric readings every time. The exclusive cuvette locking system ensures that the cuvette is inserted into the measurement cell in the same position every time to maintain a consistent path length.

### Typical content of reducing sugars in must and wine

Must	sweet must	20-25 %	200-250 g/L
	normal	10-20 %	100-200 g/L
	in fermentation	4-12.5 %	40-125 g/L
Wine	sweet	2.5-12.5 %	25-125 g/L
	semi sweet	0.8-2.5 %	8-25 g/L
	almost dry	0.2-0.8 %	2-8 g/L
	dry	0-0.2 %	0-2 g/L





Supplied in a rigid carrying case

Specifications	HI83746						
Range	0.00 to 50.00 g/L (ppt)						
Resolution	0.25 g/L						
Accuracy @25°C (77°F)	± 0.50 g/L ±5% of reading						
Precision	±0.015 @ 0.350 g/L						
Light Source	tungsten lamp						
Light Detector	silicon photocell with narrow band interference filter @ 610 nm						
Method	Fehling						
Environment	0 to 50°C; RH max 95% non-condensing						
Battery Type	1.5V AA batteries (4)/ 12 VDC adapter						
Auto Shut-off	after 15 minutes of non-use						
Dimensions	224 x 87 x 77 mm (8.7 x 3.3 x 3.1")						
Weight	512 g (17.6 oz.)						
Ordering Information	<b>HI83746-01</b> (115V) and <b>HI83746-02</b> (230V) is supplied with glass cuvettes and caps (4), reagents for about 20 tests (HI83746-20), HI93703-59 Charcoal, 200 µL automatic pipette with two plastic tips, 1000 µL automatic pipette with plastic tips (2), instruction sheet for automatic pipette, spoon, funnel, filter paper (25), cuvette wiping cloth, 12 VDC adapter, batteries, instructions and Instrument quality certificate, rigid carrying case.						
Optional Reagents	<table border="1"> <tbody> <tr> <td><b>HI83746-20</b></td> <td>reducing sugar reagent set (20 tests)</td> </tr> <tr> <td><b>HI93703-59</b></td> <td>charcoal for decoloration of red wine (about 100 tests)</td> </tr> <tr> <td><b>HI839800</b></td> <td>COD test tube heater (required)</td> </tr> </tbody> </table>	<b>HI83746-20</b>	reducing sugar reagent set (20 tests)	<b>HI93703-59</b>	charcoal for decoloration of red wine (about 100 tests)	<b>HI839800</b>	COD test tube heater (required)
<b>HI83746-20</b>	reducing sugar reagent set (20 tests)						
<b>HI93703-59</b>	charcoal for decoloration of red wine (about 100 tests)						
<b>HI839800</b>	COD test tube heater (required)						

## Significance of Use

Sugar is an essential component in the production of wine. During alcoholic fermentation, yeast consume sugars found in the grape juice, or must, and converts it to ethyl alcohol and carbon dioxide. In the case of certain styles of wine such as semi-sweet or dessert wines, some sugar is allowed to remain post-fermentation. This residual sugar can serve to provide a sweeter character to the final blend or play a role in microbial stability.

The primary fermentable sugars found in grapes are glucose and fructose. These two simple sugars are also known as reducing sugars because they contain functional groups capable of being oxidized under certain conditions. After reaction with excess alkaline cupric tartrate (Fehling reagents), the content of reducing sugars can be determined colorimetrically. The Fehling method is not an exact determination but an index of the reducing sugar concentration, because the reaction depends upon the amount and type of reducing sugars present. When the reducing sugar content is known at the beginning of fermentation, the potential alcohol degree can be estimated by multiplying the sugar concentration (in g/L) by 0.06.



The HI83746 requires the HI839800 Test Tube Heater



HI83746-20

HI83748

## Photometer for the Determination of Tartaric Acid in Wine

- **Built-in timer**
  - Display of time remaining before a measurement is taken. Ensures that all readings are taken at the appropriate reaction intervals for the test being performed.
- **Zero key**
  - A simple press of the zero key on the face of the meter will account for the color and imperfections in the oil sample before reagent addition.
- **GLP**
  - Review of the last calibration date.
- **Auto shut-off**
  - Automatic shut-off after 15 minutes of non-use when the meter is in measurement mode. Prevents wastage of batteries in the event the meter is accidentally left on.
- **Battery status indicator**
  - Indicates the amount of battery life left.
- **Error messages**
  - Messages on display alerting to problems including no cap, high zero, and standard too low.
- **Units of measure**
  - Appropriate unit of measure is displayed along with reading.

The HI83748 photometer is for the determination of tartaric acid in wine. Hanna's photometers feature an advanced optical system; the combination of a special tungsten lamp, a narrow band interference filter, and silicon photodetector ensure accurate photometric readings every time. The exclusive cuvette locking system ensures that the cuvette is inserted into the measurement cell in the same position every time to maintain a consistent path length.





Supplied in a rigid carrying case

## Significance of Use

Tartaric acid and tartrate play an important role in the stability of wines. They can be present in wine and juice in various forms, like tartaric acid (H<sub>2</sub>T), potassium bitartrate (KHT) or calcium tartrate (CaT). The ratio of these depends mainly on the pH of the wine. The percentage of tartrate present as bitartrate (HT-) is maximum at pH 3.7.

The formation of crystalline deposits (tartrate casse) is a phenomenon of wine aging that does not meet customer acceptance. It is therefore important to test for and reduce the potential for bottle precipitation. For example, by adjusting the pH of the wine, winemakers can significantly influence the potential of casse formation.

Tartaric acid concentrations in wine range normally from 1.5 to 4.0 g/L. This acid concentration should not be confused with total or titratable acidity of wines, which are often expressed as tartaric acid content as well. Although it is the tartaric acid that is the predominant acid present (up to 60% of the total acidity), others like malic, citric, and several volatile acids contribute significantly to total acidity.

Specifications	HI83748
Range	0.0 to 5.0 g/L (ppt)
Resolution	0.1 g/L
Accuracy @25°C (77°F)	±0.1 g/L ±5% of reading
Light Source	tungsten lamp
Manual Precision	SD ±0.1 g/L @ 2.0 g/L
Light Detector	silicon photocell with narrow band interference filter @ 525 nm
Method	the reaction between tartaric acid and the reagents causes a yellow/orange red tint in the sample.
Environment	0 to 50°C; RH max 95% non-condensing
Battery Type	1.5V AA batteries (4) / 12 VDC adapter
Auto Shut-off	after 15 minutes of non-use
Dimensions	225 x 85 x 80 mm (8.7 x 3.3 x 3.1")
Weight	500 g (17.6 oz.)
Ordering Information	<b>HI83748-01</b> (115V) and <b>HI83748-02</b> (230V) are supplied with sample cuvettes and caps (2), reagents for 5 manual tests (HI83748A-0, HI83748B-0), 200 µL automatic pipette, plastic tips for 200 µL automatic pipette (2), 5 mL syringe with tip, cuvette wiping cloth, 12 VDC adapter, batteries, instructions, instrument quality certificate and rigid carrying case.
Reagent Sets	<b>HI83748-20</b> tartaric acid reagents set for wine (20 tests)



HI83748-20

HI83730

## Photometer for the Determination of Peroxide Value in Olive Oils

- **Built-in timer**
  - Display of time remaining before a measurement is taken. Ensures that all readings are taken at the appropriate reaction intervals for the test being performed.
- **Zero key**
  - A simple press of the zero key on the face of the meter will account for the color and imperfections in the oil sample before reagent addition.
- **GLP**
  - Review of the last calibration date.
- **Auto shut-off**
  - Automatic shut-off after 15 minutes of non-use when the meter is in measurement mode. Prevents wastage of batteries in the event the meter is accidentally left on.
- **Battery status indicator**
  - Indicates the amount of battery life left.
- **Error messages**
  - Messages on display alerting to problems including no cap, high zero, and standard too low.
- **Units of measure**
  - Appropriate unit of measure is displayed along with reading.

The HI83730 portable photometer is for the determination of peroxide value in edible oils. Hanna's portable photometers feature an advanced optical system; the combination of a special tungsten lamp, a narrow band interference filter, and silicon photodetector ensure accurate photometric readings every time. The exclusive cuvette locking system ensures that the cuvette is inserted into the measurement cell in the same position every time to maintain a consistent path length.



### Oil Peroxides Content

<10 meq O <sub>2</sub> /kg	excellent conservation
10-15 meq O <sub>2</sub> /kg	good conservation
<10 meq O <sub>2</sub> /kg	refined oil
>20 meq O <sub>2</sub> /kg	rancid oil



Supplied in a rigid carrying case

## Significance of Use

Over time, edible oils may degrade and spoil. The primary cause of edible oil degradation is oxidation; as oil oxidation occurs, flavors and odors can change, resulting in a product that is undesirable to consumers. The unsaturated fatty acids found in oils react with oxygen, creating peroxide as an unwanted byproduct. This oxidation reaction is more likely to occur under certain conditions, including exposure to light, the presence of metal ions, the introduction of oxygen, or when storage temperatures are not maintained. In order to determine oil quality and the onset of oxidation, peroxide value is determined. Peroxide value is defined as the amount of peroxide oxygen per kilogram of oil, which is reported in units of milliequivalents or meq. A lower peroxide value indicates higher quality edible oil.

Specifications	HI83730
Range	0.0 to 25.0 meq O <sub>2</sub> /kg
Resolution	0.5 meq O <sub>2</sub> /kg
Accuracy @25°C (77°F)	±0.5 meq O <sub>2</sub> /kg
Light Source	tungsten lamp
Light Detector	silicon photocell with narrow band interference filter @ 466 nm
Method	adaptation of EC 2568/91 method and following amendments
Environment	0 to 50°C (32 to 122°F); RH max 95% non-condensing
Power Supply	1.5V AA batteries (4) / 12 VDC adapter
Auto Shut-off	after 15 minutes of non-use
Dimensions	224 x 87 x 77 mm (8.8 x 3.4 x 3")
Weight	512 g (18 oz.)
<b>Ordering Information</b>	<b>HI83730-01</b> (115V) and <b>HI83730-02</b> (230V) are supplied with reagents for 10 tests, 1 mL syringes (4), scissors, vial wiping cloth, batteries, AC adapter, instructions and a rigid carrying case.
<b>Reagent Sets</b>	<b>HI83730-20</b> peroxide in olive oil reagents kit (21 manual tests)



HI83730-20

Checker<sup>hc</sup>  
handheld colorimeter

## Hanna Checker<sup>®</sup> HC Series

### Handheld Colorimeters

The Hanna Checker HC bridges the gap between simple chemical test kits and professional instrumentation. Chemical test kits are not very accurate and only give 5 to 10 points of resolution while professional instrumentation can cost hundreds of dollars and can be time consuming to calibrate and maintain. The Checker HC is both accurate and affordable.

The contoured style of the Checker HC fits in your palm or pocket perfectly, while the large LCD is easy to read. The auto shut-off feature assures the battery life will not be drained if you forget to turn it off.

- Easier to use and more accurate than chemical test kits
  - High accuracy
  - Large, easy-to-read digits
  - Auto shut-off
- Dedicated to a single parameter
  - Designed to work with Hanna's reagents
  - Uses 10 mL glass cuvettes
- Small size, big convenience
  - Weighing a mere 64 g (2.25 oz.), the Checker<sup>®</sup>HC easily fits in your palm or pocket
- Use for quick and accurate on-the-spot analysis
- Single-button operation: zero and measure
- Operated by a single AAA battery



### Calibration Checking Sets

Our optional Checker HC Calibration Sets provide a simple solution to validating your Checker HC. Each high quality set of standards is manufactured in our state-of-the-art facility and comes supplied with a Certificate of Analysis. The Certificate of Analysis provides the lot number, reference values, and expiration date to provide traceability when certifying the Checker HC.

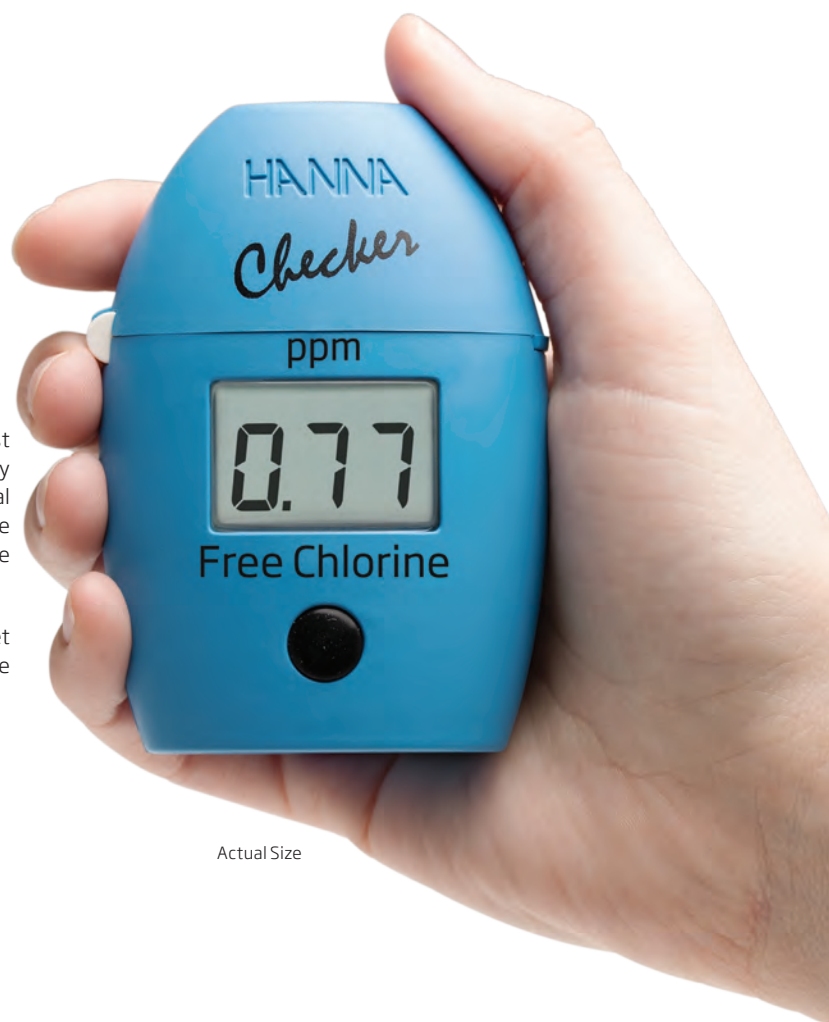

Actual Size

Checker HC's are supplied in a case with custom insert



### General Specifications for All Models

Light Detector	silicon photocell
Environment	0 to 50°C (32 to 122°F); RH max 95% non-condensing
Battery Type	1.5V AAA (1)
Dimensions	86.0 x 61.0 x 37.5 mm (3.4 x 2.4 x 1.5")
Weight	64 g (2.25 oz.)



# Seawater and Fresh Water Alkalinity

## Handheld Colorimeters

- Easier to use and more accurate than chemical test kits
- Dedicated to a single parameter
- Small size, big convenience
  - Weighing a mere 64 g (2.25 oz.), the Checker®HC easily fits into the palm of your hand or pocket
  - Use for quick and accurate on-the-spot analysis
  - Single-button operation: zero and measure
  - Operated by a single AAA battery
- Ideal for:
  - Saltwater aquariums (HI755, HI772)
  - Fresh water aquariums (HI775)
  - Swimming Pools and Spas (HI7754)



Alkalinity is one of the most important parameters to measure in aquariums. It helps to maintain a stable pH, an important factor for most aquatic life. In seawater, bicarbonate is the largest contributor to alkalinity and is a critical element needed for healthy corals. Corals need bicarbonate and carbonate available to form their skeletons. Without an adequate level, healthy coral growth is not possible. Since bicarbonate levels can be difficult to determine, total alkalinity is measured instead. The alkalinity of natural seawater is typically 125 ppm CaCO<sub>3</sub> (equivalent to 7 degrees of carbonate hardness, or dKH). In saltwater aquariums, typical alkalinity values can range from 125 to 200 ppm CaCO<sub>3</sub> (7 to 11.2 dKH).

The HI755, HI775, HI7754, and HI772 Checker HC's are simple, accurate, and cost effective ways to measure alkalinity in seawater and fresh water. Designed as a more accurate alternative to chemical test kits, these handheld colorimeters provide quick, accurate alkalinity testing results in four easy steps.

**Step One** - Add a sample to the included cuvette(s).

**Step Two** - Insert sample into the Checker HC and press the button to zero.

**Step Three** - Remove sample and add reagent as stated in the manual.

**Step Four** - Reinsert sample and press the button to measure your results.



Specifications	HI755 (Seawater)	HI775 (Fresh water)	HI7754 (Fresh water)	HI772 (Seawater)
Range	0 to 300 ppm (as CaCO <sub>3</sub> )	0 to 500 ppm (as CaCO <sub>3</sub> )	0 to 500 ppm (as CaCO <sub>3</sub> )	0.0 to 20.0 dKH
Resolution	1 ppm			0.1 dKH
Accuracy	±5 ppm ±5% of reading @ 25 °C (77 °F)			±0.3 dKH ±5% of reading @ 25 °C (77 °F)
Light Source	Light Emitting Diode @ 610 nm			
Light Detector	Silicon photocell			
Method	Colorimetric Method. The reaction causes a distinctive range of colors from yellow to greenish blue to develop.			
Environment	0 to 50°C (32 to 122°F); RH max 95% non-condensing			
Battery Type	1.5V AAA Alkaline			
Auto-off	After 10 minutes of non-use	After 10 minutes of non-use and 2 minutes after reading		After 10 minutes of non-use
Dimensions	86.0 x 61.0 x 37.5 mm (3.4 x 2.4 x 1.5")			
Weight	64 g (2.3 oz)			
Ordering Information	<b>HI755 Checker®HC</b> is supplied with sample cuvette and cap (2 pcs.), Marine Alkalinity reagent starter kit (reagents for 25 tests, 1 mL syringe with tip (1 pc.), 1.5V AAA Alkaline battery (1 pc.), and instruction manual			
	<b>HI775 and HI7754 (Pool Line) Checker®HC</b> are supplied with sample cuvette and cap (2 pcs.), Alkalinity reagent starter kit (reagents for 25 tests), 1 mL syringe with tip, 1.5V AAA Alkaline battery (1 pc.), and instruction manual.			
	<b>HI772 Checker®HC</b> is supplied with sample cuvette and cap (2 pcs.), Marine Alkalinity reagent starter kit (reagents for 25 tests), 1 mL syringe with tip, 1.5V AAA Alkaline battery (1 pc.), and instruction manual.			
Reagent Set	<b>HI755-26</b> Reagents for 25 Marine Alkalinity tests	<b>HI775-26</b> Reagents for 25 Alkalinity tests, 1 syringe and 1 tip	<b>HI7754-26</b> Reagents for 25 Alkalinity tests, 1 syringe and 1 tip	<b>HI772-26</b> Reagents for 25 Marine Alkalinity tests, 1 syringe and 1 tip
Calibration Set	<b>HI755-11</b> Marine Alkalinity certified standard kit	<b>HI775-11</b> Alkalinity certified standard kit	<b>HI7754-11</b> Alkalinity certified standard kit	<b>HI772-11</b> Marine Alkalinity certified standard kit
Accessories		<b>HI937554-53</b> Chlorine remover reagent	<b>HI937554-53</b> Chlorine remover reagent	



HI784

## Marine Ammonia

Handheld Colorimeter

- Easier to use and more accurate than chemical test kits
- Dedicated to a single parameter
- Small size, big convenience
  - Weighing a mere 64 g (2.25 oz.), the Checker®HC easily fits into the palm of your hand or pocket
  - Quick and accurate on-the-spot analysis
  - Single-button operation: zero and measure
  - Operated by a single 1.5V AAA battery
- Ideal for:
  - Aquariums
  - Marine biology

Ammonia is a by-product of the Nitrogen cycle. Ammonia is normally removed by nitrifying bacteria, but ammonia levels can rise if there is an imbalance in the tank water chemistry. Excessive ammonia in a marine aquarium increases the risk of inhabitant illness or death.

The HI784 Marine Ammonia Checker®HC is a handheld colorimeter that uses the Beer-Lambert principle to determine the concentration of ammonia colorimetrically. The HI784 is designed specifically to measure ammonia levels in a saltwater aquarium. The 0.00 to 2.50 ppm range is ideal for coral/fish or fish-only aquarium maintenance.



Specifications	HI784
Range	0.00 to 2.50 ppm (mg/L) NH <sub>3</sub>
Resolution	0.01 ppm (mg/L)
Accuracy	±0.05 ppm ±5% of reading @ 25 °C (77 °F)
Light Source	Light Emitting Diode @ 610 nm
Light Detector	Silicon photocell
Method	Adaptation of the Salicylate Method. The reaction between Ammonia and Ammonium and the reagent causes a blue-green tint in the sample.
Environment	0 to 50 °C (32 to 122 °F); max. 95% RH non-condensing Prepared sample cuvette (sample plus reagents) must be 18 to 29 °C (65 to 85 °F)*.
Battery Type	1.5V AAA Alkaline
Auto shut-off	After 20 minutes of non-use and 10 minutes after reading
Dimensions	86.0 x 61.0 x 37.5 mm (3.4 x 2.4 x 1.5")
Weight	64 g (2.3 oz)
<b>Ordering Information</b>	<b>HI784</b> Checker®HC is supplied with Marine Ammonia reagent starter kit (reagents for 10 tests), sample cuvette and cap (2 pcs.), plastic refilling pipette (1 pc.), 1.5V AAA alkaline battery (1 pc.), instruction manual, and quick-reference guide.
<b>Reagent Set</b>	<b>HI784-25</b> Reagents for 25 Marine Ammonia tests
<b>Calibration Set</b>	<b>HI784-11</b> Marine Ammonia certified standard kit

\* Warm or cool prepared cuvettes if needed.

HI700 · HI715 · HI733

## Ammonia Low, Medium, and High Range

### Handheld Colorimeters

- Easier to use and more accurate than chemical test kits
- Dedicated to a single parameter
- Small size, big convenience
  - Weighing a mere 64 g (2.25 oz.), the Checker®HC easily fits into the palm of your hand or pocket
  - Quick and accurate on-the-spot analysis
  - Single-button operation: zero and measure
  - Operated by a single 1.5V AAA battery
- Ideal for:
  - Water quality
  - Aquariums
  - Environmental

The HI700, HI715, and HI733 Checker®HC's are simple, accurate, and cost effective ways to measure ranges of ammonia in fresh water.

Designed as a more accurate alternative to chemical test kits, the HI700, HI715, and the HI733\* provides quick, accurate results.

**Step One** - Add a sample to the included cuvette(s).

**Step Two** - Insert sample into the Checker HC and press the button to zero.

**Step Three** - Remove sample and add reagents as the manual states.

**Step Four** - Reinsert sample, press and hold the button for 3 seconds to start reaction timer. reading will be taken automatically and the results displayed.

\* HI733 uses a different procedure

All three models use an adaptation of the ASTM Manual of Water and Environmental Technology, D1426-92, Nessler method. The reaction between ammonia and reagents causes a yellow tint in the sample.



Specifications	HI700 (LR)	HI715 (MR)	HI733 (HR)
Range	0.00 to 3.00 ppm (as NH <sub>3</sub> -N)	0.00 to 9.99 ppm (as NH <sub>3</sub> -N)	0.0 to 99.9 ppm as NH <sub>4</sub> <sup>+</sup>
Resolution	0.01 ppm	0.01 ppm	0.1 ppm
Accuracy	±0.05 ppm ±5% of reading @ 25 °C (77 °F)	±0.05 ppm ±5% of reading @ 25 °C (77 °F)	±1.0 ppm ±5% of reading @ 25 °C (77 °F)
Light Source	Light Emitting Diode @ 470 nm		
Light Detector	Silicon photocell		
Method	Adaptation of the ASTM Manual of Water and Environmental Technology, D1426-92, Nessler Method. The reaction between ammonia and reagents causes a yellow tint in the sample.		
Environment	0 to 50 °C (32 to 122 °F); max. 95% RH non-condensing		
Battery Type	1.5V AAA Alkaline		
Auto-off	After 10 minutes of non-use		
Dimensions	86.0 x 61.0 x 37.5 mm (3.4 x 2.4 x 1.5")		
Weight	64 g (2.3 oz)		
Ordering Information	<p><b>HI700</b> Checker®HC is supplied with sample cuvette and cap (2 pcs.), Ammonia Low Range reagent starter kit (reagents for 25 tests), 1.5V AAA Alkaline battery (1 pc.), and instruction manual.</p> <p><b>HI715</b> Checker®HC is supplied with sample cuvette and cap (2 pcs.), Ammonia Medium Range reagent starter kit (reagents for 25 tests), 1.5V AAA Alkaline battery (1 pc.), and instruction manual.</p> <p><b>HI733</b> Checker®HC is supplied with sample cuvettes with caps (2), Ammonia High Range reagent starter kit (reagents for 10 tests), 1 mL syringe with tip (1 pc.), Plastic pipette (1 pc.), 1.5V AAA Alkaline battery (1 pc.), and instruction manual.</p>		
Reagent Set	<b>HI700-25</b> Reagents for 25 Ammonia Low Range tests	<b>HI715-25</b> Reagents for 25 Ammonia Medium Range tests	<b>HI733-25</b> Reagents for 20 Ammonia High Range tests
Calibration Set	<b>HI700-11</b> Ammonia Low Range certified standard kit	<b>HI715-11</b> Ammonia Medium Range certified standard kit	<b>HI733-11</b> Ammonia High Range certified standard kit

HI716

# Bromine

## Handheld Colorimeter

- **Easier to use and more accurate than chemical test kits**
  - DPD method
  - Accuracy  $\pm 0.08$  ppm  $\pm 5\%$  of reading
  - 0.01 ppm resolution
  - Large, easy-to-read digits
  - Auto shut-off
- **Dedicated to a single parameter**
  - Designed to work with Hanna's powder reagents
  - Uses 10 mL glass cuvettes
- **Small size, big convenience**
  - Weighing a mere 64 g (2.25 oz.), the Checker®HC easily fits into the palm of your hand or pocket
  - Built-in reaction timer
  - Operated by a single 1.5V AAA battery
- **Ideal for:**
  - Water quality
  - Education
  - Swimming pools/hot tub sanitization
  - Environmental



The HI716 Checker HC is a simple, accurate, and cost effective way to measure bromine. Designed as a more accurate alternative to chemical test kits, the HI716 provides quick, accurate results in four easy steps.

**Step One** - Add a sample to the included cuvette(s).

**Step Two** - Insert sample into the Checker HC and press button to zero.

**Step Three** - Remove sample and add reagent packet.

**Step Four** - Reinsert sample, press and hold the button for 3 seconds to start reaction timer. reading will be taken automatically and the results displayed.

The HI716 uses an adaptation of the Standard Methods for the Examination of Water and Wastewater, 18th edition, DPD method. The reaction between bromine and the reagent causes a pink tint in the sample.

Specifications	HI716
Range	0.00 to 8.00 ppm (as Br <sub>2</sub> )
Resolution	0.01 ppm
Accuracy	$\pm 0.08$ ppm $\pm 5\%$ of reading @ 25 °C (77 °F)
Light Source	Light Emitting Diode @ 525 nm
Light Detector	Silicon photocal
Method	Adaptation of the Standard Methods for the Examination of Water and Wastewater, 18th Edition, DPD Method. The reaction between bromine and the reagent causes a pink tint in the sample.
Environment	0 to 50 °C (32 to 122 °F); max. 95% RH non-condensing
Battery Type	1.5V AAA Alkaline
Auto-off	After 10 minutes of non-use
Dimensions	86.0 x 61.0 x 37.5 mm (3.4 x 2.4 x 1.5")
Weight	64 g (2.3 oz)
<b>Ordering Information</b>	<b>HI716</b> Checker®HC is supplied with sample cuvette and cap (2 pcs.), Bromine reagent starter kit (reagents for 6 tests), 1.5V AAA Alkaline battery (1 pc.), and instruction manual.
<b>Reagent Set</b>	<b>HI716-25</b> Reagents for 25 Bromine tests
<b>Calibration Set</b>	<b>HI716-11</b> Bromine certified standard kit

HI758

## Marine Calcium

Handheld Colorimeter

- Easier to use and more accurate than chemical test kits
  - Zincon method adaptation
  - $\pm 6\%$  of reading
  - 1 ppm resolution
  - Large, easy-to-read digits
  - Auto shut-off
- Dedicated to a single parameter
  - Uses 10 mL glass cuvettes
- Small size, big convenience
  - Weighing a mere 64 g (2.25 oz.), the Checker®HC easily fits into the palm of your hand or pocket
  - Quick and accurate on-the-spot analysis
  - Single-button operation: zero and measure
  - Operated by a single 1.5V AAA battery
- Ideal for:
  - Aquaculture
  - Aquariums



HI758 includes HI731339P 100µL pipette and 1 mL syringe

Calcium present in water supplies results from passage over deposits of limestone, dolomite, gypsum, and gypsiferous shale. The concentration may extend from 0 to several hundred milligrams per liter, depending on its source and treatment. Calcium is necessary in plant and animal nutrition since it is an essential constituent of bones, shells and plant structures. Calcium in water as carbonate is one of the primary components of water hardness which can cause pipe or tube scaling.

The HI758 Calcium Checker HC is extremely simple to use. First, zero with Reagent A and deionized water. Next, remove the vial and add sample and Reagent B and shake to dissolve. Reinsert into the Checker HC and press the button to read the calcium concentration in ppm on the display.

HI731339P volumetric pipette is designed to measure and transfer exactly 100 µL of solution to a cuvette. To obtain the highest accuracy and precision from the HI758 it is necessary to add exactly 100 µL of aquarium saltwater to the cuvette. Any variation will result in an inaccurate reading.

Specifications	HI758
Range	200 to 600 ppm (as $\text{Ca}^{2+}$ )
Resolution	1 ppm
Accuracy @25°C (77°F)	$\pm 6$ ppm $\pm 5\%$ of reading @ 25 °C (77 °F)
Light Source	Light Emitting Diode @ 610 nm
Light Detector	Silicon photocell
Method	Adaptation of the Zincon Method
Environment	0 to 50 °C (32 to 122 °F); max. 95% RH non-condensing
Battery Type	1.5V AAA Alkaline
Auto-off	After 10 minutes of non-use and 2 minutes after reading
Dimensions	86.0 x 61.0 x 37.5 mm (3.4 x 2.4 x 1.5")
Weight	64 g (2.3 oz)
Ordering Information	<b>HI758</b> Checker®HC is supplied with Sample cuvette and cap (2 pcs.), Marine Calcium reagent starter kit (reagents for 25 tests, 1 mL syringe with tip (1 pc.), Minipipette with tip (1 pc.), Plastic pipette (1 pc.), 1.5V AAA Alkaline battery (1 pc.), and instruction manual.
Reagent Set	<b>HI758-26</b> Reagents for 25 Marine Calcium tests
Calibration Set	<b>HI758-11</b> Marine Calcium certified standard kit
Accessories	<b>HI731339P</b> 0.1 mL minipipette <b>HI731349P</b> Tip for 0.1 mL minipipette (10 pcs.)

HI753

# Chloride

## Handheld Colorimeter

- Easier to use and more accurate than chemical test kits
- Dedicated to a single parameter
- Small size, big convenience
  - Weighing a mere 64 g (2.25 oz.), the Checker®HC easily fits into the palm of your hand or pocket
  - Quick and accurate on-the-spot analysis
  - Single-button operation: zero and measure
  - Operated by a single AAA battery
- Ideal for:
  - Drinking water
  - Waste water
  - Boiler and cooling towers

The HI753 Checker®HC is a simple, accurate, and cost effective way to measure chloride. Designed as a more accurate alternative to chemical test kits, the HI753 provides quick, accurate results in three easy steps.

**Step One** - Prepare samples according to the manual.

**Step Two** - Insert zero cuvette into the Checker HC, press and hold the button for 3 seconds to start reaction timer. Meter will zero automatically.

**Step Three** - Remove zero cuvette and insert sample. Press the button to measure your results.

The HI753 uses an adaptation of the mercury(II) thiocyanate method.



Specifications	HI753
Range	0.0 to 20.0 ppm (as Cl <sup>-</sup> )
Resolution	0.1 ppm
Accuracy	0.5 ppm ±6% of reading @ 25 °C (77 °F)
Light Source	Light Emitting Diode @ 470 nm
Light Detector	Silicon photocell
Method	Adaptation of the Mercury(II) Thiocyanate Method. The chloride ion displace thiocyanate ion from mercury(II). The iron(III) present forms with thiocyanate an orange colored complex. The intensity of the color is proportional to the chloride ion concentration.
Environment	0 to 50 °C (32 to 122 °F); max. 95% RH non-condensing
Battery Type	1.5V AAA Alkaline
Auto-off	After 10 minutes of non-use
Dimensions	86.0 x 61.0 x 37.5 mm (3.4 x 2.4 x 1.5")
Weight	64 g (2.3 oz)
Ordering Information	<b>HI753</b> Checker®HC is supplied with sample cuvette and cap (2 pcs.), Chloride reagent starter kit (reagents for 25 tests), 1 mL syringe with tip (2 pcs.), 1.5V AAA alkaline battery (1 pc.), and instruction manual
Reagent Set	<b>HI753-25</b> Reagents for 25 Chloride tests
Calibration Set	<b>HI753-11</b> Chloride certified standard kit

HI701 · HI7014 · HI762

# Free Chlorine and Ultra Low Range Free Chlorine

## Handheld Colorimeter

- Easier to use and more accurate than chemical test kits
  - EPA approved DPD method
  - Large, easy-to-read digits
  - Auto shut off
- Dedicated to a single parameter
- Small size, big convenience
  - The Checker®HC easily fits into the palm of your hand or pocket
  - Quick and accurate on-the-spot analysis
  - Single-button operation: zero and measure
- Ideal for:
  - Swimming pools and spas
  - Fruit and vegetable sanitation
  - Disinfection
  - Drinking water and quality control checks



Pool  
Line

The HI701, HI7014, and HI762 Checker®HC bridge the gap between simple chemical test kits and professional instrumentation. Chemical test kits are not very accurate and only give 5 to 10 points of resolution, while professional instrumentation can cost hundreds of dollars and can be time consuming to calibrate and maintain. These meters are accurate and affordable.

The HI701 and HI7014 features a resolution of 0.01 ppm and  $\pm 0.03$  ppm  $\pm 3\%$  of reading accuracy while the HI762 features a resolution of 1 ppb and  $\pm 20$  ppb  $\pm 4\%$  of reading accuracy. These meters use an EPA approved DPD method.

The contoured style of the Checker HC fits in your palm or pocket perfectly and the large LCD is easy to read. The auto shut-off feature assures the battery life will not be drained if you forget to turn it off.

These meters are extremely simple to use. First, zero the instrument with your water sample. Next, add the reagent. Lastly, place the vial into the Checker HC, press the button and read the results. It's that easy.

Specifications	HI701	HI7014	HI762 (ULR)
Range	0.00 to 2.50 ppm (as Cl <sub>2</sub> )	0.00 to 2.50 ppm (as Cl <sub>2</sub> )	0 to 500 ppb (as Cl <sub>2</sub> )
Resolution	0.01 ppm	0.01 ppm	1 ppb
Accuracy	$\pm 0.03$ ppm $\pm 3\%$ of reading @ 25 °C (77 °F)	0.03 ppm $\pm 3\%$ of reading @ 25 °C (77 °F)	$\pm 20$ ppb $\pm 4\%$ of reading @ 25 °C (77 °F)
Light Source	Light Emitting Diode @ 525 nm		
Light Detector	Silicon photocell		
Method	Adaptation of US EPA Method 330.5. The reaction between free chlorine and the DPD reagent causes a pink tint in the sample.		
Environment	0 to 50 °C (32 to 122 °F); max. 95% RH non-condensing		
Battery Type	1.5V AAA Alkaline		
Auto-off	After 2 minutes of non-use	After 2 minutes of non-use	After 10 minutes of non-use
Dimensions	86.0 x 61.0 x 37.5 mm (3.4 x 2.4 x 1.5")		
Weight	64 g (2.3 oz)		
Ordering Information	<b>HI701 and HI7014</b> (Pool Line) Checker®HC are supplied with sample cuvette and cap (2 pcs.), Free Chlorine reagent starter kit (reagents for 6 tests), 1.5V AAA Alkaline battery (1 pc.), instruction manual.		
	<b>HI762</b> Checker®HC is supplied with Sample cuvette and cap (2 pcs.), Free Chlorine Ultra Low Range reagent starter kit (reagents for 6 tests), 1.5V AAA Alkaline battery (1 pc.), instruction manual.		
Reagent Set	<b>HI701-25</b> Reagents for 25 Free Chlorine tests	<b>HI7014-25</b> Reagents for 25 Free Chlorine tests	<b>HI762-25</b> Reagents for 25 Free Chlorine Ultra Low Range tests
Calibration Set	<b>HI701-11</b> Free Chlorine certified standard kit	<b>HI7014-11</b> Free Chlorine certified standard kit	<b>HI762-11</b> Free Chlorine Ultra Low Range certified standard kit

HI711 · HI761 · HI771

# Total, Total Ultra Low Range, and Ultra High Range Chlorine

## Handheld Colorimeters

- Easier to use and more accurate than chemical test kits
- Dedicated to a single parameter
- Small size, big convenience
- Ideal for:
  - Swimming pools and spas
  - Fruit and vegetable sanitation/disinfection
  - Drinking water
  - Quality control checks
  - Environmental
  - Hospitality
  - Food processing



Chlorine is the most commonly used water disinfectant. The monitoring of chlorine is crucial in applications such as swimming pools and spas, fruit and vegetable sanitation, disinfection, and drinking water. By monitoring this crucial parameter, serious health and safety risks can be avoided.

The HI711, HI761, and HI771 Checker®HC Handheld Colorimeters bridge the gap between simple chemical test kits and professional instrumentation. Chemical test kits are not very accurate and only give 5 to 10 points of resolution, while professional instrumentation can cost hundreds of dollars and can be time consuming to calibrate and maintain. Hanna's Checker HC's are an accurate and affordable alternative.

The contoured style of these Checkers fit easily in the palm of your hand or pocket and the large LCD is easy to read. The auto shut-off feature assures the battery life will not be drained if you forget to turn it off.

These Checker HC's are designed to be portable and easy to use, providing quick, accurate results in four easy steps.

Specifications	HI711 (Total)	HI761 (Total ULR)	HI771 (UHR)
Range	0.00 to 3.50 ppm (as Cl <sub>2</sub> )	0 to 500 ppb (as Cl <sub>2</sub> )	0 to 500 ppm (as Cl <sub>2</sub> )
Resolution	0.01 ppm	1 ppb	1 ppm
Accuracy	0.03 ppm ±3% of reading @ 25 °C (77 °F)	±5 ppb ±5% of reading @ 25 °C (77 °F)	±3 ppm ±5% of reading @ 25 °C (77 °F)
Light Source	Light Emitting Diode @ 525 nm		
Light Detector	Silicon photocell		
Method	Adaptation of USEPA Method 330.5. The reaction between free chlorine and the DPD reagent causes a pink tint in the sample.		Adaptation of the Standard Methods for the Examination of Water & Wastewater, 20th Edition, 4500-Cl
Environment	0 to 50 °C (32 to 122 °F); max. 95% RH non-condensing		
Battery Type	1.5V AAA Alkaline		
Auto-off	After 10 minutes of non-use and 2 minutes after reading	After 10 minutes of non-use	After 10 minutes of non-use
Dimensions	86.0 x 61.0 x 37.5 mm (3.4 x 2.4 x 1.5")		
Weight	64 g (2.3 oz)		
Method	Adaptation of USEPA Method 330.5. The reaction between free chlorine and the DPD reagent causes a pink tint in the sample.		adaptation of the Standard Methods for the Examination of Water and Wastewater, 20th edition, 4500-Cl.
Ordering Information	<p><b>HI711</b> Checker®HC is supplied with sample cuvette and cap (2 pcs.), Total Chlorine reagent starter kit (reagents for 6 tests), 1.5V AAA alkaline battery (1 pc.), and instruction manual.</p> <p><b>HI761</b> Checker®HC is supplied with sample cuvette and cap (2 pcs.), Total Chlorine Ultra Low Range reagent starter kit (reagents for 6 tests), 1.5V AAA alkaline battery (1 pc.), and instruction manual.</p> <p><b>HI771</b> Checker®HC is supplied with sample cuvette and cap (2 pcs.), Chlorine Ultra High Range reagent starter kit (reagents for 6 tests), 1.5V AAA alkaline battery (1 pc.), and instruction manual.</p>		
Reagent Set	<b>HI711-25</b> Reagents for 25 Total Chlorine tests	<b>HI761-25</b> Reagents for 25 Total Chlorine Ultra Low Range tests	<b>HI771-25</b> Reagents for 25 Chlorine Ultra High Range tests
Calibration Set	<b>HI711-11</b> Total Chlorine certified standard kit	<b>HI761-11</b> Total Chlorine ULR certified standard kit	<b>HI771-11</b> Chlorine Ultra High Range certified standard kit



HI749 · HI723

## Chromium VI Low Range and High Range

Handheld Colorimeters

- Easier to use and more accurate than chemical test kits
- Dedicated to a single parameter
- Small size, big convenience
- Ideal for:
  - Water quality
  - Environmental
  - Plating
  - Education

There are two natural forms of ionic chromium: the hexavalent Cr(VI) and the trivalent Cr(III). Cr(III) is much less toxic than Cr(VI) and seldom found in potable waters. Cr(VI), however, is toxic to humans and is found in water. Even though the toxic effects from Cr(VI) in drinking water are not well documented, it is a suspected carcinogen.

There are many industries that use chromic acid and other forms of Cr(VI) that could be a possible source of Cr(VI) pollution in either water, air, or both. One industry that can introduce Cr(VI) to water sources is the chrome-plating industry. Chromic acid is used in the electroplating process and can be present in industrial waste waters. Cr(VI) can also enter water supplies from industrial cooling towers where chromic acid is added to the water to inhibit metal corrosion.

The maximum permissible level of Cr(VI) allowed to be released into the waterways is 50 ppb. Its level in drinking water is normally much lower, and a level higher than 3 ppb is suggestive of industrial pollution.

The HI723 and HI749 Checker®HC Handheld Colorimeters are a simple, accurate, and cost effective way to measure Cr(VI). Each model is designed for a specific range (low or high) in order to provide high levels of accuracy.

The contoured style of these Checker HC's fit easily in the palm of your hand or pocket and the large LCD is easy to read. The auto shut-off feature assures the battery life will not be drained if you forget to turn it off.



Specifications	HI749 (LR)	HI723 (HR)
Range	0 to 300 ppb (as Cr(IV))	0 to 999 ppb (as Cr(VI))
Resolution	1 ppb	1 ppb
Accuracy	±3 ppb ±5% of reading @ 25 °C (77 °F)	±5 ppb ±4% of reading @ 25 °C (77 °F)
Light Source	Light Emitting Diode @ 525 nm	
Light Detector	Silicon photocell	
Method	Adaptation of the ASTM Manual of Water and Environmental Technology, D1687-92, Diphenylcarbohydrazide Method. The reaction between chromium(VI) and the reagent causes a purple tint in the sample.	
Environment	0 to 50 °C (32 to 122 °F); max. 95% RH non-condensing	
Battery Type	1.5V AAA Alkaline	
Auto-off	After 10 minutes of non-use	After 10 minutes of non-use and 2 minutes after reading
Dimensions	86.0 x 61.0 x 37.5 mm (3.4 x 2.4 x 1.5")	
Weight	64 g (2.3 oz)	
Ordering Information	<p><b>HI749</b> Checker®HC is supplied with sample cuvette and cap (2 pcs.), Chromium VI Low Range reagent starter kit (reagents for 6 tests), 1.5V AAA alkaline battery (1 pc.), and instruction manual.</p> <p><b>HI723</b> Checker®HC is supplied with sample cuvette and cap (2 pcs.), Chromium VI High Range reagent starter kit (reagents for 6 tests), 1.5V AAA alkaline battery (1 pc.), and instruction manual.</p>	
Reagent Set	<b>HI749-25</b> Reagents for 25 Chromium VI Low Range tests	<b>HI723-25</b> Reagents for 25 Chromium VI High Range tests
Calibration Set	<b>HI749-11</b> Chromium VI Low Range certified standard kit	<b>HI723-11</b> Chromium VI High Range certified standard kit

## Color of Water

### Handheld Colorimeter

- Easier to use and more accurate than chemical test kits
- Dedicated to a single parameter
- Small size, big convenience
- Ideal for water quality

True color is caused by dissolved compounds in water and can be both natural or artificial. Apparent color is caused by both dissolved and suspended solids. Color is measured in Platinum-Cobalt units (PCU). The AWWA recommends  $\leq 15$  PCU.

The term "true color" is defined as the color of water from which turbidity has been removed. The term "apparent color" includes not only color due to substances in solution, but also color that is due to suspended matter. Apparent color is determined on the original sample without filtration or centrifugation. In some highly-colored industrial wastewaters, color is contributed principally by colloidal or suspended material. In such cases, both true color and apparent color should be determined.

To determine true color, turbidity must be removed before analysis. Methods for removing turbidity without removing color vary. Filtration yields results that are reproducible from day to day among laboratories, however, some filtration procedures may also remove some true color. Centrifugation avoids interaction of color with filter materials, but results vary with the sample nature, size, and speed of the centrifuge. When sample dilution is necessary, whether it precedes or follows turbidity removal, it can alter the measured color. Acceptable pretreatment procedures are included with each method. The pretreatment method should be stated when reporting the results.

The HI727 Checker®HC is very simple to use. First, zero the instrument with deionized water. Next, prepare the sample according to the Apparent/True color measurement. Place the second vial with prepared sample into the Checker HC, press the operational button and the HI727 Checker® displays the color of water in PCU.



Specifications	HI727
Range	0 to 500 g/L PCU
Resolution	5 PCU
Accuracy	$\pm 10$ PCU $\pm 5\%$ of reading @ 25 °C (77 °F)
Light Source	Light Emitting Diode @ 470 nm
Light Detector	Silicon photocell
Method	Adaptation of the Standard Methods for the Examination of Water and Wastewater 21st Edition, Colorimetric Platinum Cobalt Method
Environment	0 to 50 °C (32 to 122 °F); max. 95% RH non-condensing
Battery Type	1.5V AAA Alkaline
Auto-off	After 10 minutes of non-use and 2 minutes after reading
Dimensions	86.0 x 61.0 x 37.5 mm (3.4 x 2.4 x 1.5")
Weight	64 g (2.3 oz)
<b>Ordering Information</b>	<b>HI727</b> Checker®HC is supplied with sample cuvette and cap (2 pcs.), 1.5V AAA Alkaline battery (1 pc.), and instruction manual.
<b>Calibration Set</b>	<b>HI727-11</b> Color of Water certified standard kit
<b>Accessories</b>	<b>HI40227</b> Filter assembly
	<b>HI40228</b> Filter disc (25 pcs.)



HI783

## Marine Magnesium

Handheld Colorimeter

- Easier to use and more accurate than chemical test kits
- Dedicated to a single parameter
- Small size, big convenience
  - Weighing a mere 64 g (2.25 oz.), the Checker®HC easily fits into the palm of your hand or pocket
  - Quick and accurate on-the-spot analysis
  - Single-button operation: zero and measure
- Ideal for:
  - Aquariums
  - Marine biology

Magnesium is the third most abundant ion in seawater, surpassed only by sodium and chloride. Its abundance is critical in the formation of weak ion pairs with carbonate ions. This allows calcium and carbonate ions to be available for uptake by corals and invertebrates. Low levels of magnesium lead to low or unstable levels of calcium and alkalinity. Signs of low magnesium levels include precipitation of calcium as insoluble calcium carbonate and impaired inhabitant growth and health.

The HI783 Marine Magnesium Checker®HC is a handheld colorimeter that uses the Beer-Lambert principle to determine the concentration of magnesium colorimetrically. The HI783 is designed specifically to measure magnesium levels in a saltwater aquarium or in marine biology applications. The 1000 to 1800 ppm range is ideal for coral/fish or fish-only aquarium maintenance.



Specifications	HI783
Range	1000 to 1800 ppm Magnesium
Resolution	5 ppm
Accuracy	±5% of reading @ 25 °C (77 °F)
Light Source	Light Emitting Diode @ 610 nm
Light Detector	Silicon photocell
Method	Adaptation of the colorimetric EDTA method using calmagite indicator. The reaction between magnesium and the reagents causes a blue to violet tint in the sample.
Environment	0 to 50 °C (32 to 122 °F); max. 95% RH non-condensing Prepared sample cuvette (sample plus reagents) must be 22 to 28 °C (72 to 82 °F).*
Battery Type	1.5V AAA Alkaline
Auto shut-off	After 10 minutes of non-use
Dimensions	86.0 x 61.0 x 37.5 mm (3.4 x 2.4 x 1.5")
Weight	64 g (2.3 oz)
Interferences	Calcium below 300 ppm and above 500 ppm
Ordering Information	<b>HI783</b> Checker®HC is supplied with sample cuvette and cap (2 pcs.), Marine Magnesium reagent starter kit (reagents for 25 tests), 5 mL syringe (black printing) and tip (1 pc.), 5 mL syringe (blue printing) and tip (1 pc.), 1.5V AAA Alkaline battery (1 pc.), instruction manual, and quick-reference guide.
Reagent Set	<b>HI783-25</b> Reagents for 25 Marine Magnesium tests
Calibration Set	<b>HI783-11</b> Marine Magnesium certified standard kit

\* Warm or cool prepared cuvettes if needed.

# Maple Syrup Digital Grader

## Handheld Colorimeter

- Easy to use
- Results are displayed % transmittance
- Small size, big convenience

The season of maple syrup production spans several months between winter and spring each year. As the days get longer and warmer and the nights stay below freezing, the sap from maple trees begins to flow and tapping begins. At the beginning of production season, the sap produces a lighter, sweeter syrup comprised of sucrose as the main sugar content. As the season progresses and temperatures rise, microorganisms grow and colonize the sap as it is collected. These bacteria, while not harmful, convert part of the sucrose present into invert sugars, glucose and fructose. The level of invert sugars in the sap, as well as the chemical processes that occur during boiling, are responsible for creating a darker and stronger flavored syrup product.

Maple syrup grading standards for the United States and Canada allow consumers to easily distinguish between the different grades of syrup, regardless of the place of origin.

The HI759 Maple Syrup Digital Grader is a handheld colorimeter designed for quick, accurate determination of the grade of maple syrup. The HI759 is designed as a more accurate alternative to temporary and permanent visual grading kits, providing quick, accurate results in four easy steps.

**Step One** - Add a sample to the included cuvette(s).

**Step Two** - Insert the glycerol reference cuvette, close the lid, and press the button to zero.

**Step Three** - Remove the glycerol reference cuvette and replace with a sample cuvette.

**Step Four** - Close the lid and press the button. Reading will be taken automatically and the results displayed.

This Maple Syrup Digital Grader measures the percent light transmittance of the syrup and directly displays the percentage results on the large, easy to read LCD display. Located on the back of the meter is a chart referencing the percent light transmittance to the grade. Eliminating the subjectivity of grading by eye and the potential for mislabeling, the HI759 is grading made simple.



### State of Vermont Grades and Standards (New IMSI\* standards)

Grade A Color Classes	Taste	Light Transmittance
Grade A Golden	Delicate	≥ 75
Grade A Amber	Rich	50 to 74
Grade A Dark	Robust	25 to 49
Grade A Very Dark	Strong	< 25

\* International Maple Syrup Institute

Specifications	HI759
Range	0 to 100% transmittance
Resolution	1% transmittance
Accuracy	±4% transmittance
Light Source	Light Emitting Diode @ 560 nm
Light Detector	Silicon photocell
Environment	0 to 50 °C (32 to 122 °F); max. 95% RH non-condensing
Battery Type	1.5V AAA Alkaline
Auto-off	After 10 minutes of non-use
Dimensions	86.0 x 61.0 x 37.5 mm (3.4 x 2.4 x 1.5")
Weight	64 g (2.3 oz)
Ordering Information	<b>HI759</b> Checker®HC is supplied with sample cuvette and cap (3 pcs.), glycerol reference cuvette, 20 mL beakers (3 pcs.), 1.5V AAA Alkaline battery (1 pc.), and instruction manual.
Accessories	<b>HI759-11</b> Glycerol standard cuvettes (2 pcs.) <b>HI731359</b> Round glass cuvettes with caps (25 pcs.)

HI747 · HI702 · HI7024

## Copper Low Range and High Range

Handheld Colorimeters

- Easier to use and more accurate than chemical test kits
- Dedicated to a single parameter
- Small size, big convenience
- Ideal for:
  - Water Quality
  - Education
  - Aquarium
  - Wastewater
  - Environmental



The HI702, HI7024, and HI747 Checker®HC are a simple, accurate, and cost effective way to measure high and low ranges of copper. Designed as a more accurate alternative to chemical test kits, these meters provide quick, accurate results in four easy steps.

**Step One** - Add a sample to the included cuvette(s).

**Step Two** - Insert sample into the Checker HC and press button to zero.

**Step Three** - Remove sample and add reagent packet.

**Step Four** - Reinsert sample, press and hold the button for 3 seconds to start reaction timer. Reading will be taken automatically and the results displayed.

The HI702, HI7024, and HI747 use an adaptation of the EPA method. The reaction between copper and the bicinchoninate reagent causes a purple tint in the sample.

Pool  
Line

Specifications	HI747 (LR)	HI702 (HR)	HI7024 (HR)
Range	0 to 999 ppb (as Cu <sup>2+</sup> )	0.00 to 5.00 ppm (as Cu <sup>2+</sup> )	0.00 to 5.00 ppm (as Cu <sup>2+</sup> )
Resolution	1 ppb	0.01 ppm	0.01 ppm
Accuracy	±10 ppb ±5% of reading @ 25 °C (77 °F)	±0.05 ppm ±5% of reading @ 25 °C (77 °F)	±0.05 ppm ±5% of reading @ 25 °C (77 °F)
Light Source	Light Emitting Diode @ 575 nm		
Light Detector	Silicon photocell		
Method	Adaptation of the EPA approved method. The reaction between copper and the bicinchoninate reagent causes a purple tint in the sample.		
Environment	0 to 50 °C (32 to 122 °F); max. 95% RH non-condensing		
Battery Type	1.5V AAA Alkaline		
Auto-off	After 10 minutes of non-use		
Dimensions	86.0 x 61.0 x 37.5 mm (3.4 x 2.4 x 1.5")		
Weight	64 g (2.3 oz)		
Ordering Information	<p><b>HI747</b> Checker®HC is supplied with sample cuvette and cap (2 pcs.), Copper Low Range reagent starter kit (reagents for 6 tests), 1.5V AAA Alkaline battery (1 pc.), and instruction manual.</p> <p><b>HI702</b> and <b>HI7024</b> (Pool Line) Checker®HC are supplied with sample cuvette and cap (2 pcs.), Copper High Range reagent starter kit (reagents for 6 tests), 1.5V AAA Alkaline battery (1 pc.), and instruction manual..</p>		
Reagent Set	<b>HI747-25</b> Reagents for 25 Copper Low Range tests	<b>HI702-25</b> Reagents for 25 Copper High Range tests	<b>HI7024-25</b> Reagents for 25 Copper High Range tests
Calibration Set	<b>HI747-11</b> Copper Low Range certified standard kit	<b>HI702-11</b> Copper High Range certified standard kit	<b>HI7024-11</b> Copper High Range certified standard kit

\* Excluding sample volume error

# Fluoride Low Range and High Range

## Handheld Colorimeters

- Easier to use and more accurate than chemical test kits
- Dedicated to a single parameter
- Small size, big convenience
- Ideal for water quality

Fluoride is one of the very few chemicals that have been shown to cause significant effects in people through drinking water. Fluoride has beneficial effects on teeth at low concentrations in drinking water, but excessive exposure to fluoride in drinking water, or in combination with exposure to fluoride from other sources, can give rise to a number of adverse effects.

A 1994 World Health Organization expert committee suggested a level of fluoride from 0.5 to 1.0 ppm, depending on climate. Bottled water typically has unknown fluoride levels, and some domestic water filters remove some or all fluoride.



Specifications	HI729 (LR)	HI739 (HR)
Range	0.00 to 2.00 ppm (as F <sup>-</sup> )	0.0 to 20.0 ppm (as F <sup>-</sup> )
Resolution	0.01 ppm	0.1 ppm
Accuracy	0.10 ppm ±5% of reading @ 25 °C (77 °F)	0.5 ppm ±5% of reading @25 °C (77 °F)
Light Source	Light Emitting Diode @ 575 nm	
Light Detector	Silicon photocell	
Method	Adaptation of the Standard Methods for the Examination of Water and Wastewater, 18th Edition, SPADNS Method	
Environment	0 to 50 °C (32 to 122 °F); max. 95% RH non-condensing	
Battery Type	1.5V AAA Alkaline	
Auto-off	After 10 minutes of non-use and 2 minutes after reading	
Dimensions	86.0 x 61.0 x 37.5 mm (3.4 x 2.4 x 1.5")	
Weight	64 g (2.3 oz)	
Ordering Information	<p><b>HI729</b> Checker®HC is supplied with sample cuvette and cap (2 pcs.), Fluoride Low Range reagent starter kit (reagents for 6 tests), 1 mL syringe with tip, 1.5V AAA alkaline battery (1 pc.), and instruction manual.</p> <p><b>HI739</b> Checker®HC is supplied with sample cuvette and cap (2 pcs.), Fluoride High Range reagent starter kit (reagents for 15 tests), 1 mL syringe with tip, Plastic pipette (1 pc.), 1.5V AAA alkaline battery (1 pc.), and instruction manual.</p>	
Reagent Set	<b>HI729-26</b> Reagents for 20 Fluoride Low Range tests	<b>HI739-26</b> Reagents for 30 Fluoride High Range tests
Calibration Set	<b>HI729-11</b> Fluoride Low Range certified standard kit	<b>HI739-11</b> Fluoride High Range certified standard kit

HI735

## Total Hardness Low Range

Handheld Colorimeter

- Easier to use and more accurate than chemical test kits
- Dedicated to a single parameter
- Small size, big convenience
- Ideal for:
  - Drinking water
  - Process water
  - heating and cooling systems
  - swimming pools and spas

HI735 Total Hardness Low Range handheld checker is designed to determine total hardness (as CaCO<sub>3</sub>) in drinking and process water, heating and cooling systems, swimming pools and spas. Also suitable to be used in agriculture, food and beverage industries.

HI735 features a single-button operation system and is easy to use.

The large LCD is easy to read and the auto shut-off feature assures the battery will not be drained.



Specifications	HI735
Range	0 to 350 ppm (mg/L) as CaCO <sub>3</sub>
Resolution	1 ppm (mg/L)
Accuracy	±6 ppm ±6% of reading @ 25 °C (77 °F)
Light Source	Light Emitting Diode @ 470 nm
Light Detector	silicon photocell
Method	Adaptation of the EPA recommended Method 130.1. The reaction between calcium, magnesium, and the reagents causes a red-violet tint in the sample.
Environment	0 to 50 °C (32 to 122 °F); max. 95% RH non-condensing
Battery Type	1.5V AAA Alkaline
Auto-off	After 10 minutes of non-use
Dimensions	86.0 x 61.0 x 37.5 mm (3.4 x 2.4 x 1.5")
Weight	64 g (2.3 oz)
Ordering Information	<b>HI735</b> Checker®HC is supplied with Total Hardness Low Range reagent starter kit (reagents for 12 tests), sample cuvette and cap (2 pcs.), 1 mL graduated syringe with tip (2 pcs.), plastic refilling pipette (1 pc.), 1.5V AAA alkaline battery (1 pc.), and instruction manual.
Reagent Set	<b>HI735-25</b> Reagents for 25 Total Hardness Low Range tests
Calibration Set	<b>HI735-11</b> Total Hardness Low Range certified standard kit
Accessories	<b>HI740143</b> 1 mL graduated syringe (6 pcs.)
	<b>HI740144P</b> Plastic pipette tip (10 pcs.)
	<b>HI740157P</b> Plastic refilling pipette (20 pcs.)

# Magnesium and Calcium Hardness

## Handheld Colorimeters

- Easier to use and more accurate than chemical test kits
- Dedicated to a single parameter
- Small size, big convenience
- Ideal for:
  - Water purification systems
  - Heating and cooling systems
  - Drinking water
  - Wastewater

The HI719 and HI720 are a simple, accurate, and cost effective way to measure magnesium and calcium hardness respectively.

The HI719 uses an adaptation of the Standard Methods for the Examination of Water and Wastewater, 18th edition, EDTA colorimetric method. The reaction between magnesium and reagents causes a reddish-violet tint in the sample.

The HI720 uses an adaptation of the Standard Methods for the Examination of Water and Wastewater, 18th edition, Calmagite method. The reaction between calcium and reagents causes a reddish-violet tint in the sample.



Specifications	HI719 (Magnesium Hardness)	HI720 (Calcium Hardness)
Range	0.00 to 2.00 ppm (as CaCO <sub>3</sub> )	0.00 to 2.70 ppm (as CaCO <sub>3</sub> )
Resolution	0.01 ppm	0.01 ppm
Accuracy	±0.20 ppm ±5% of reading @ 25 °C (77 °F)	±0.20 ppm ±5% of reading @ 25 °C (77 °F)
Light Source	Light Emitting Diode @ 525 nm	
Light Detector	Silicon photocell	
Method	Adaptation of the Standard Methods for the Examination of Water and Wastewater, 18th Edition, EDTA Colorimetric Method. The reaction between magnesium and reagents causes a reddish-violet tint in the sample.	adaptation of the Standard Methods for the Examination of Water and Wastewater, 18th edition, Calmagite method. The reaction between calcium and reagents causes a reddish-violet tint in the sample
Environment	0 to 50 °C (32 to 122 °F); max. 95% RH non-condensing	
Battery Type	1.5V AAA Alkaline	
Auto-off	After 10 minutes of non-use	
Dimensions	86.0 x 61.0 x 37.5 mm (3.4 x 2.4 x 1.5")	
Weight	64 g (2.3 oz)	
Ordering Information	<p><b>HI719</b> Checker®HC is supplied with sample cuvette and cap (2 pcs.), Magnesium Hardness reagent starter kit (reagents for 50 tests), 100 mL plastic beaker (1 pc.), 1 mL syringe with tips (2 pcs.), 1.5V AAA Alkaline battery (1 pc.), and instruction manual.</p> <p><b>HI720</b> Checker®HC is supplied with sample cuvette and cap (2 pcs.), Calcium Hardness reagent starter kit (reagents for 50 tests), 100 mL plastic beaker (1 pc.), 1 mL syringe with tip (2 pcs.), 1.5V AAA Alkaline battery (1 pc.), and instruction manual.</p>	
Reagent Set	<b>HI719-25</b> Reagents for 50 Magnesium Hardness tests	<b>HI720-25</b> Reagents for 50 Calcium Hardness tests
Calibration Set	<b>HI719-11</b> Magnesium Hardness certified standard kit	<b>HI720-11</b> Calcium Hardness certified standard kit



HI718

## Iodine

Handheld Colorimeter

- Easier to use and more accurate than chemical test kits
  - DPD method
  - $\pm 0.1 \text{ ppm} \pm 5\%$  of reading accuracy
  - Large, easy-to-read digits
  - Auto shut-off
- Dedicated to a single parameter
  - Designed to work with Hanna's powder reagents
- Small size, big convenience
  - Weighing a mere 64 g (2.25 oz.), the Checker®HC easily fits into the palm of your hand or pocket
  - Quick and accurate on-the-spot analysis
  - Single-button operation: zero and measure
- Ideal for:
  - Swimming pools and spas
  - Industrial processes and disinfection

Iodine is sometimes used as a disinfectant for swimming pools, spas and potable water. It has also found use as a disinfectant in the poultry industry. The rapid determination of iodine is required for adequate control of this bactericide.

The Hanna Checker®HC bridges the gap between simple chemical test kits and professional instrumentation. Chemical test kits are not very accurate and only give 5 to 10 of points resolution, while professional instrumentation can cost hundreds of dollars and can be time-consuming to calibrate and maintain. The HI718 Checker HC is both accurate and affordable.

The HI718 Checker HC portable handheld colorimeter features a resolution of 0.1 ppm and accuracy of  $\pm 0.1 \text{ ppm} \pm 5\%$  of reading. This Checker HC uses a modification of the DPD method used for residual chlorine.

The contoured style of this Checker HC fits in your palm or pocket perfectly and the large LCD is easy to read. The auto shut-off feature assures the battery life will not be drained if you forget to turn it off.



Specifications	HI718
Range	0.0 to 12.5 ppm (as I <sub>2</sub> )
Resolution	0.1 ppm
Accuracy	$\pm 0.1 \text{ ppm} \pm 5\%$ of reading @ 25 °C (77 °F)
Light Source	Light Emitting Diode @ 525 nm
Light Detector	Silicon photocell
Method	Adaptation of the Standard Methods for the Examination of Water and Wastewater, 18th Edition, Periodate Method. The reaction between iodine and the reagent causes a pink tint in the sample.
Environment	0 to 50 °C (32 to 122 °F); max. 95% RH non-condensing
Battery Type	1.5V AAA Alkaline
Auto-off	After 10 minutes of non-use and 2 minutes after reading
Dimensions	86.0 x 61.0 x 37.5 mm (3.4 x 2.4 x 1.5")
Weight	64 g (2.3 oz)
Ordering Information	<b>HI718</b> Checker®HC is supplied with sample cuvette and cap (2 pcs.), Iodine reagent starter kit (reagents for 6 tests), 1.5V AAA Alkaline battery (1 pc.), and instruction manual.
Reagent Set	<b>HI718-25</b> Reagents for 25 Iodine tests
Calibration Set	<b>HI718-11</b> Iodine certified standard kit

HI746 · HI721 · HI7214

## Iron Low Range and High Range

### Handheld Colorimeters

- Easier to use and more accurate than chemical test kits
- Dedicated to a single parameter
- Small size, big convenience
- Ideal for:
  - Industrial ground and treated waters
  - Mining leachate monitoring
  - Agricultural irrigation water
  - Pools and spas

About 6.3% of the earth's crust is made of iron, of which 43% is in soils. The analysis of iron is often performed to monitor ground water and irrigation waters as a gauge of corrosion from industrial settling, and as an indication of the effectiveness of treatment from mining leachate.

The Hanna HI746, HI721, and HI7214 Checker®HC bridge the gap between simple chemical test kits and professional instrumentation. Chemical test kits are not very accurate and only give 5 to 10 points of resolution, while professional instrumentation can cost hundreds of dollars and can be time-consuming to calibrate and maintain. These meters are accurate, affordable, and produce immediate results.

The HI721 and HI7214 features a resolution of 0.01 ppm and  $\pm 0.04$  ppm  $\pm 2\%$  of reading accuracy while the HI746 features 1 ppb resolution and  $\pm 20$  ppb  $\pm 5\%$  of reading accuracy.

The contoured style of these meters fit in your palm or pocket perfectly and the large LCD is easy to read. The auto shut-off feature assures battery life will not be drained if you forget to turn it off.



Pool  
Line

Specifications	HI746 (LR)	HI721 (HR)	HI7214 (HR)
Range	0 to 999 ppb (as Fe)	0.00 to 5.00 ppm (as Fe)	0.00 to 5.00 ppm (as Fe)
Resolution	1 ppb	0.01 ppm	0.01 ppm
Accuracy	$\pm 20$ ppb $\pm 5\%$ of reading @ 25 °C (77 °F)	$\pm 0.04$ ppm $\pm 2\%$ of reading @ 25 °C (77 °F)	$\pm 0.04$ ppm $\pm 2\%$ of reading @ 25 °C (77 °F)
Light Source	Light Emitting Diode @ 575 nm	Light Emitting Diode @ 525 nm	Light Emitting Diode @ 525 nm
Light Detector	Silicon photocell		
Method	Adaptation of the TPTZ Method. The reaction between iron and the reagent causes a violet tint in the sample.	Adaptation of the Standard Methods for the Examination of Water and Wastewater, 23rd Edition, 3500-Fe B, Phenanthroline Method. The reaction between iron and reagent causes an orange tint in the sample.	
Environment	0 to 50 °C (32 to 122 °F); max. 95% RH non-condensing		
Battery Type	1.5V AAA Alkaline		
Auto-off	After 10 minutes of non-use	After 10 minutes of non-use and 2 minutes after reading	
Dimensions	86.0 x 61.0 x 37.5 mm (3.4 x 2.4 x 1.5")		
Weight	64 g (2.3 oz)		
Ordering Information	<p><b>HI746</b> Checker®HC is supplied with sample cuvette and cap (2 pcs.), Iron Low Range reagent starter kit (reagents for 25 tests), 25 mL glass cylinders with rubber cap (2 pcs.), 1.5V AAA Alkaline battery (1 pc.), and instruction manual.</p> <p><b>HI721</b> Checker®HC is supplied with sample cuvette and cap (2 pcs.), Iron High Range reagent starter kit (reagents for 6 tests), 1.5V AAA Alkaline battery (1 pc.), and instruction manual.</p> <p><b>HI7214</b> Checker®HC is supplied with sample cuvette and cap (2 pcs.), Iron High Range reagent starter kit (reagents for 6 tests), 1.5V AAA Alkaline battery (1 pc.), and instruction manual.</p>		
Reagent Set	<b>HI746-25</b> Reagents for 25 Iron Low Range tests	<b>HI721-25</b> Reagents for 25 Iron High Range tests	<b>HI7214-25</b> Reagents for 25 Iron High Range tests
Calibration Set	<b>HI746-11</b> Iron Low Range certified standard kit	<b>HI721-11</b> Iron High Range certified standard kit	<b>HI7214-11</b> Iron High Range certified standard kit

HI709

# Manganese High Range

Handheld Colorimeter

- Easier to use and more accurate than chemical test kits
- Dedicated to a single parameter
- Small size, big convenience
- Ideal for:
  - Water Quality
  - Education
  - Aquarium
  - Wastewater
  - Environmental

The HI709 Checker®HC is a simple, accurate, and cost effective way to measure high ranges of manganese. Designed as a more accurate alternative to chemical test kits, the HI709 provides quick, accurate results in four easy steps.

**Step One** - Add a sample to the included cuvette(s).

**Step Two** - Insert sample into the Checker HC and press the button to zero.

**Step Three** - Remove sample and add reagent.

**Step Four** - Reinsert sample, press and hold the button for 3 seconds to start reaction timer. Reading will be taken automatically and the results displayed.

The HI709 uses an adaptation of the Standard Methods for the Examination of Water and Wastewater, 18th edition, Periodate method. The reaction between manganese and reagents causes a pink tint in the sample.



Specifications	HI709 (HR)
Range	0.0 to 20.0 ppm (as Mn)
Resolution	0.1 ppm
Accuracy	±0.2 ppm ±5% of reading @ 25 °C (77 °F)
Light Source	Light Emitting Diode @ 525 nm
Light Detector	Silicon photocell
Method	Adaptation of the Standard Methods for the Examination of Water and Wastewater, 18th Edition, Periodate Method. The reaction between manganese and the reagent causes a pink tint in the sample.
Environment	0 to 50 °C (32 to 122 °F); max. 95% RH non-condensing
Battery Type	1.5V AAA Alkaline
Auto-off	After 10 minutes of non-use
Dimensions	86.0 x 61.0 x 37.5 mm (3.4 x 2.4 x 1.5")
Weight	64 g (2.3 oz)
Ordering Information	<b>HI709</b> Checker®HC is supplied with sample cuvette and cap (2 pcs.), Manganese High Range reagent starter kit (reagents for 6 tests), 1.5V AAA Alkaline battery (1 pc.), instruction manual.
Reagent Set	<b>HI709-25</b> Reagents for 25 Manganese High Range tests
Calibration Set	<b>HI709-11</b> Manganese High Range certified standard kit

# Nickel High Range

## Handheld Colorimeter

- Easier to use and more accurate than chemical test kits
- Dedicated to a single parameter
- Small size, big convenience
- Ideal for:
  - Steel manufacturing
  - Electroplating and electronics production

Nickel is extensively used in electroplating, the manufacturing of steel, electronic devices, ceramics and colored glasses. It plays a vital role in many processes of applied sciences and fundamental sciences.

Nickel is seldom found in natural waters, but is often present in industrial wastewater as a direct by-product of metal plating baths, and as a corrosion by-product of stainless steel, nickel or cobalt alloys.

The most serious effects of nickel exposure include lung cancer and other respiratory effects in people who have breathed nickel dust while working in nickel refineries or in nickel processing plants. Other lung effects including chronic bronchitis and reduced lung function have been observed in workers breathing nickel. The levels of nickel in the workplace were much higher than background levels. The International Agency for Research on Cancer (IARC) has determined that some nickel compounds are carcinogenic to humans and that metallic nickel may be carcinogenic to humans. The EPA has determined that nickel refinery dust and nickel subsulfide are human carcinogens.

The HI726 Checker®HC is extremely simple to use. First, zero the instrument with your water sample. Next, add the reagent, shake gently until complete dissolution. Finally, place the vial into the Checker HC, press the button for 3 seconds. The display will show the countdown prior to the measurement. When the timer ends the meter will perform the reading and display concentration in g/L of nickel. It's that easy.



Specifications	HI726 (HR)
Range	0.00 to 7.00 g/L (ppt) (as Ni)
Resolution	0.01 g/L
Accuracy	±0.10 g/L ±5% of reading @ 25 °C (77 °F)
Light Source	Light Emitting Diode @ 575 nm
Light Detector	Silicon photocell
Method	Adaptation of the Photometric Method. The reaction between nickel and the reagent causes a blue tint in the sample.
Environment	0 to 50 °C (32 to 122 °F); max. 95% RH non-condensing
Battery Type	1.5V AAA Alkaline
Auto-off	After 10 minutes of non-use and 2 minutes after reading
Dimensions	86.0 x 61.0 x 37.5 mm (3.4 x 2.4 x 1.5")
Weight	64 g (2.3 oz)
<b>Ordering Information</b>	<b>HI726 Checker®HC</b> is supplied with sample cuvette and cap (2 pcs.), Nickel High Range reagent starter kit (reagents for 6 tests), 1.5V AAA Alkaline battery (1 pc.), and instruction manual.
<b>Reagent Set</b>	<b>HI726-25</b> Reagents for 25 Nickel High Range tests
<b>Calibration Set</b>	<b>HI726-11</b> Nickel High Range certified standard kit

HI781

## Marine Nitrate Low Range

Handheld Colorimeter

- Ideal for aquariums and marine biology
- Easier to use and more accurate than chemical test kits
- Small size, big convenience

Nitrate is a by-product of the Nitrogen Cycle. Excessive amounts of nitrates in a reef aquarium can promote the growth of undesirable organisms including algae and dinoflagellates while insufficient amounts can lead to starvation in which SPS and other corals will show signs including the loss of color and paleness.

The HI781 Nitrate Checker HC is a handheld colorimeter that uses the Beer-Lambert principle to determine the concentration of nitrate colorimetrically. The HI781 is designed specifically to measure low levels of nitrate in a saltwater aquarium. The 0.00 to 5.00 ppm range is ideal for reef aquarium maintenance.



Specifications	HI781 (LR)
Range	0.00 to 5.00 ppm (as NO <sub>3</sub> <sup>-</sup> ) 0.0 to 50.0 ppm (calculated) using dilution
Resolution	0.01 ppm
Accuracy	0.25 ppm ±2% of reading @ 25 °C (77 °F) ±2.5 ppm ± 5% of calculated reading using dilution
Light Source	Light Emitting Diode @ 525 nm
Light Detector	Silicon photocell
Method	Zinc Reduction method. The reaction between nitrate and the reagent causes a pink/violet tint in the sample. This checker has been developed to work with seawater samples.
Interferences	Nitrite, copper
Environment	0 to 50 °C (32 to 122 °F); max. 95% RH non-condensing
Battery Type	1.5V AAA Alkaline
Auto-off	After 10 minutes of non-use
Dimensions	86.0 x 61.0 x 37.5 mm (3.4 x 2.4 x 1.5")
Weight	64 g (2.3 oz)
Ordering Information	<b>HI781</b> Checker HC is supplied with Marine Nitrate Low Range reagent starter kit (reagents for 25 tests, sample cuvette and cap (2 pcs.), filter paper (25 pcs.), filter holder (1 pc.), mixing vial and cap (1 pc.), 5 mL syringe with tip (1 pc.), 10 mL syringe (1 pc.), 1 mL graduated syringe (1 pc.), plastic refilling pipette (1 pc.), 16 gauge blunt needle (1 pc.), 1.5V AAA alkaline battery (1 pc.), and instruction manual.
Reagent Set	<b>HI781-25</b> Reagents for 25 Marine Nitrate Low Range tests
Calibration Set	<b>HI781-11</b> Marine Nitrate Low Range certified standard kit



HI782

## Marine Nitrate High Range

Handheld Colorimeter

- Ideal for aquariums and marine biology
- Easier to use and more accurate than chemical test kits
- Small size, big convenience

Nitrate is a by-product of the Nitrogen cycle. Excessive amounts of Nitrates in a marine aquarium can promote the growth of undesirable organisms including algae and dinoflagellates and increase the risk of livestock illness or death.

The HI782 Marine Nitrate HR (High Range) Checker HC is a handheld colorimeter that uses the Beer-Lambert principle to determine the concentration of nitrate colorimetrically. The HI782 is designed specifically to measure high levels of nitrate in a saltwater aquarium. The 0.0 to 75.0 ppm range is ideal for coral/fish or fish-only aquarium maintenance.



Specifications	HI782 (HR)
Range	0.0 to 75.0 ppm (as NO <sub>3</sub> <sup>-</sup> )
Resolution	0.1 ppm
Accuracy	±2.0 ppm ±5% of reading @ 25 °C (77 °F)
Light Source	Light Emitting Diode @ 525 nm
Light Detector	Silicon photocell
Method	Zinc reduction method. The reaction between nitrate and the reagent causes a pink tint in the sample. This checker has been developed to work with seawater samples.
Environment	0 to 50 °C (32 to 122 °F); max. 95% RH non-condensing
Battery Type	1.5V AAA Alkaline
Auto-off	After 10 minutes of non-use
Dimensions	86.0 x 61.0 x 37.5 mm (3.4 x 2.4 x 1.5")
Weight	64 g (2.3 oz)
Interferences	Nitrite
<b>Ordering Information</b>	<b>HI782</b> Checker HC is supplied with sample cuvette and cap (2 pcs.), Marine Nitrate High Range reagent starter kit (reagents for 10 tests), 3 mL Pasteur pipette (1 pc.), 1.5V AAA Alkaline battery (1 pc.), and instruction manual
<b>Reagent Set</b>	<b>HI782-25</b> Reagents for 25 Marine Nitrate High Range tests
<b>Calibration Set</b>	<b>HI782-11</b> Marine Nitrate HR certified standard kit

HI707 · HI708

## Nitrite Low Range, and High Range

Handheld Colorimeters

- Easier to use and more accurate than chemical test kits
- Dedicated to a single parameter
- Small size, big convenience
- Ideal for:
  - Aquaculture
  - Aquariums
  - Education
  - Environmental
  - Water quality
  - Wastewater

The HI707 and HI708 Checker®HC Handheld Colorimeters bridge the gap between simple chemical test kits and professional instrumentation. Chemical test kits are not very accurate, while professional instrumentation can cost hundreds of dollars and can be time-consuming to calibrate and maintain. Hanna Checker HC's are accurate, affordable, and easy to use.

To begin measurements, first zero the instrument with your water sample. Next, add the reagent. Last, place the vial into the Checker HC, press and hold the button for 3 seconds to start reaction timer. The reading will be taken automatically and the results displayed. It's that easy.

The contoured style of the Checker HC fits in your palm and pocket perfectly and the large LCD is easy to read. The auto shut-off feature assures the battery life will not be drained if you forget to turn it off.



Specifications	HI707 (LR)	HI708 (HR)
Range	0 to 600 ppb NO <sub>2</sub> <sup>-</sup> -N	0 to 150 ppm NO <sub>2</sub> <sup>-</sup>
Resolution	1 ppb	1 ppm
Accuracy	±20 ppb ±5% of reading @ 25 °C (77 °F)	±3 ppm ±5% of reading @ 25 °C (77 °F)
Light Source	Light Emitting Diode @ 470 nm	Light Emitting Diode @ 575 nm
Light Detector	Silicon photocell	
Method	Adaptation of the EPA Diazotization Method 354.1. The reaction between nitrite and the reagent causes a pink tint in the sample.	Adaptation of the Ferrous Sulfate Method. The reaction between nitrite and the reagent causes a greenish-brown tint in the sample.
Environment	0 to 50 °C (32 to 122 °F); max. 95% RH non-condensing	
Battery Type	1.5V AAA Alkaline	
Auto-off	After 20 minutes of non-use and 4 minutes after reading	After 20 minutes of non-use and 2 minutes after reading
Dimensions	86.0 x 61.0 x 37.5 mm (3.4 x 2.4 x 1.5")	
Weight	64 g (2.3 oz)	
Ordering Information	<p><b>HI707</b> Checker®HC is supplied with sample cuvette and cap (2 pcs.), Nitrite Low Range reagent starter kit (reagents for 6 tests), 1.5V AAA Alkaline battery (1 pc.), and instruction manual.</p> <p><b>HI708</b> Checker®HC is supplied with sample cuvette and cap (2 pcs.), Nitrite High Range reagent starter kit (reagents for 6 tests), 1.5V AAA Alkaline battery (1 pc.), instruction manual.</p>	
Reagent Set	<b>HI707-25</b> Reagents for 25 Nitrite Low Range tests	<b>HI708-25</b> Reagents for 25 Nitrite High Range tests
Calibration Set	<b>HI707-11</b> Nitrite Low Range certified standard kit	<b>HI708-11</b> Nitrite High Range certified standard kit



HI764 · HI767

## Marine Nitrite Low Range and Marine Nitrite Ultra Low Range

Handheld Colorimeters

- Easier to use and more accurate than chemical test kits
- Dedicated to a single parameter
- Small size, big convenience

Nitrification is the biological oxidation of ammonia (ammonium ion) into nitrite, followed by the oxidation of nitrite to nitrate. The first step of this two-step process is carried out in an aquarium by nitrifying bacteria. During this process, the ammonium levels drop while the nitrite levels increase. Since nitrite is just as harmful as ammonia, nitrite levels should be maintained at immeasurable levels. A mature biological filter should be able to keep nitrite levels low.

HI767 and HI764 Checker®HC Handheld Colorimeters bridge the gap between simple chemical test kits and professional instrumentation. Chemical test kits are not very accurate, while professional instrumentation can cost hundreds of dollars and can be time-consuming to calibrate and maintain. Hanna Checker HC's are accurate, affordable, and easy to use.

To begin measurements, first zero the instrument with your water sample. Next, add the reagent. Last, place the vial into the Checker HC, press and hold the button for 3 seconds to start reaction timer. The reading will be taken automatically and the results displayed. It's that easy.

The contoured style of the Checker HC fits in your palm and pocket perfectly and the large LCD is easy to read. The auto shut-off feature assures the battery life will not be drained if you forget to turn it off.



Specifications	HI764 (Marine ULR)	HI767 (Marine LR)
Range	0 to 200 ppb (as NO <sub>2</sub> <sup>-</sup> -N)	0 to 999 ppb (as NO <sub>2</sub> <sup>-</sup> -N)
Resolution	1 ppb	1 ppb
Accuracy	±10 ppb ±4% of reading @ 25 °C (77 °F)	±10 ppb ±4% of reading @ 25 °C (77 °F)
Light Source	Light Emitting Diode @ 525 nm	Light Emitting Diode @ 470 nm
Light Detector	Silicon photocell	
Method	Adaptation of the EPA Diazotization Method 354.1. The reaction between nitrite and the reagent causes a pink tint in the sample.	
Environment	0 to 50 °C (32 to 122 °F); max. 95% RH non-condensing	
Battery Type	1.5V AAA Alkaline	
Auto-off	After 10 minutes of non-use and 2 minutes after reading	After 20 minutes of non-use and 4 minutes after reading
Dimensions	86.0 x 61.0 x 37.5 mm (3.4 x 2.4 x 1.5")	
Weight	64 g (2.3 oz)	
Ordering Information	<p><b>HI764</b> Checker®HC is supplied with sample cuvette and cap (2 pcs.), Marine Nitrite Ultra Low Range reagent starter kit (reagents for 6 tests), 1.5V AAA Alkaline battery (1 pc.), instruction manual.</p> <p><b>HI767</b> Checker®HC is supplied with sample cuvette and cap (2 pcs.), Marine Nitrite Low Range reagent starter kit (reagents for 10 tests), 1.5V AAA Alkaline battery (1 pc.), instruction manual.</p>	
Reagent Set	<b>HI764-25</b> Reagents for 25 Nitrite Ultra Low Range tests	<b>HI767-25</b> Reagents for 25 Marine Nitrite Low Range tests
Calibration Set	<b>HI764-11</b> Nitrite Ultra Low Range certified standard kit	<b>HI767-11</b> Marine Nitrite Low Range certified standard kit





HI780

## Marine pH

Handheld Colorimeter

- Easier to use and more accurate than chemical test kits
- Dedicated to a single parameter
- Small size, big convenience

pH of ocean surface water is normally 7.5 to 8.5 pH. Over the years however, acidification tendency is to decrease 0.1 to 0.2 pH units/century. Acidification is a consequence of carbon dioxide (CO<sub>2</sub>) absorption in seawaters and oceans. Carbon dioxide reacts with seawater to produce carbonic acid (H<sub>2</sub>CO<sub>3</sub>).

pH modifications affect marine life growth, reproduction, and communication. Hydrogen ions have a tendency to bond with carbonate to form bicarbonate. The greater attraction to carbonate over calcium can adversely affect skeleton building and can limit coral growth.

The HI780 Checker HC is a simple, accurate, and cost effective way to measure pH in seawater. Designed as a more accurate alternative to chemical test kits, this handheld colorimeter provides quick, accurate pH testing results.

Specifications	HI780
Range	6.3 to 8.6 pH
Resolution	0.1 pH
Accuracy	0.2 pH of reading @ 25 °C (77 °F)
Light Source	Light Emitting Diode @ 525 nm
Light Detector	Silicon photocell
Method	Colorimetric Adaptation of Phenol Red Method
Environment	0 to 50 °C (32 to 122 °F); max. 95% RH non-condensing
Battery Type	1.5V AAA Alkaline
Auto-off	After 10 minutes of non-use
Dimensions	86.0 x 61.0 x 37.5 mm (3.4 x 2.4 x 1.5")
Weight	64 g (2.3 oz)
<b>Ordering Information</b>	<b>HI780</b> Checker HC is supplied with sample cuvette and cap (2 pcs.), Marine pH reagent starter kit, 1.5V AAA Alkaline battery (1 pc.), and instruction manual.
<b>Reagent Set</b>	<b>HI780-25</b> Reagents for approximately 100 Marine pH tests
<b>Calibration Set</b>	<b>HI780-11</b> Marine pH certified standard kit

HI779

pH

*Handheld Colorimeter*

- Easier to use and more accurate than chemical test kits
- Dedicated to a single parameter
- Small size, big convenience

The HI779 Checker HC is a simple, accurate, and cost effective way to measure pH in swimming pools, hot tubs, and spas. Designed as a more accurate alternative to chemical test kits, this handheld colorimeter provides quick, accurate pH testing results.



Specifications	HI779
Range	6.3 to 8.6 pH
Resolution	0.1 pH
Accuracy	±0.2 pH of reading @ 25 °C (77 °F)
Light Source	Light Emitting Diode @ 525 nm
Light Detector	Silicon photocell
Method	Colorimetric Adaptation of Phenol Red Method
Environment	0 to 50 °C (32 to 122 °F); max. 95% RH non-condensing
Battery Type	1.5V AAA Alkaline
Auto-off	After 10 minutes of non-use
Dimensions	86.0 x 61.0 x 37.5 mm (3.4 x 2.4 x 1.5")
Weight	64 g (2.3 oz)
<b>Ordering Information</b>	<b>HI779</b> Checker HC is supplied with sample cuvette and cap (2 pcs.), Swimming pool pH reagent starter kit, 1.5V AAA Alkaline battery (1 pc.), and instruction manual.
<b>Reagent Set</b>	<b>HI779-25</b> Reagents for approximately 100 Swimming pool pH tests
<b>Calibration Set</b>	<b>HI779-11</b> Swimming pool pH certified standard kit

HI774 · HI713 · HI7134 · HI717

# Phosphate

## Handheld Colorimeters

- Easier to use and more accurate than chemical test kits
- Dedicated to a single parameter
- Small size, big convenience
- Ideal for:
  - Aquaculture
  - natural, waste, agricultural and drinking waters
  - Pools and spas



Orthophosphates are found in natural waters and wastewaters. They are commonly added to drinking water as a corrosion inhibitor. The instantaneous analysis of orthophosphates by colorimetric determination provides rapid results using a standard analysis technique.

The Hanna HI774, HI713, HI7134 and HI717 Checker®HC bridges the gap between simple chemical test kits and professional instrumentation. Chemical test kits are not very accurate and only give some points resolution, while professional instrumentation can cost hundreds of dollars and can be time-consuming to calibrate and maintain. These Checker HC's are accurate and affordable.

The HI774 Checker HC is a simple, accurate, and cost effective way to measure ultra low range phosphates in seawater. HI774 features a resolution of 0.01 ppm and  $\pm 0.02$  ppm  $\pm 5\%$  of reading accuracy. The HI774 Checker HC uses an adaptation of the Ascorbic Acid method.

The HI713 and HI7134 Checker HC portable handheld colorimeters features a resolution of 0.01 ppm and  $\pm 0.04$  ppm  $\pm 4\%$  of reading accuracy. The HI713 Checker HC uses an adaptation of the Ascorbic Acid method.

The HI717 Checker HC portable handheld colorimeter features a resolution of 0.1 ppm and  $\pm 1.0$  ppm  $\pm 5\%$  of reading accuracy. The HI717 Checker HC uses an adaptation of the Standard Methods for the Examination of Water and Wastewater, 18th edition, Amino Acid method.

Specifications	HI774 (Marine ULR)	HI713 (LR)	HI7134 (LR)	HI717 (HR)
Range	0.00 to 0.90 ppm	0.00 to 2.50 ppm (as $\text{PO}_4^{3-}$ )		0.0 to 30.0 ppm (as $\text{PO}_4^{3-}$ )
Resolution	0.01 ppm	0.01 ppm		0.1 ppm
Accuracy	$\pm 0.02$ ppm $\pm 5\%$ of reading @ 25 °C (77 °F)	$\pm 0.04$ ppm $\pm 4\%$ of reading @ 25 °C (77 °F)		$\pm 1.0$ ppm $\pm 5\%$ of reading @ 25 °C (77 °F)
Light Source	Light Emitting Diode @ 525 nm			
Light Detector	Silicon photocell			
Method	Adaptation of Standard Methods for the Examination of Water & Wastewater, 20th Edition, Ascorbic Acid Method. The reaction between phosphate and the reagent causes a blue tint in the sample.		Adaptation of the Standard Methods for the Examination of Water and Wastewater, 18th Edition, Heteropoly-molybdenum Blue Method. The reaction between orthophosphate (reactive phosphorus) and the reagent causes a blue tint in the sample.	
Environment	0 to 50 °C (32 to 122 °F); max. RH 95% non-condensing			
Battery Type	1.5V AAA Alkaline			
Auto-off	After 7 minutes of non-use and 2 minutes after reading	After 10 minutes of non-use and 2 minutes after reading		
Dimensions	86.0 x 61.0 x 37.5 mm (3.4 x 2.4 x 1.5")			
Weight	64 g (2.3 oz)			
Ordering Information	<p><b>HI774</b> Checker®HC is supplied with sample cuvette and cap (2 pcs.), Marine Phosphate Ultra Low Range reagent starter kit (reagents for 10 tests), 1.5V AAA Alkaline battery (1 pc.), and instruction manual.</p> <p><b>HI713</b> and <b>HI7134</b> Checker®HC is supplied with sample cuvette and cap (2 pcs.), Phosphate Low Range reagent starter kit (reagents for 6 tests), 1.5V AAA Alkaline battery (1 pc.), and instruction manual.</p> <p><b>HI717</b> Checker®HC is supplied with sample cuvette and cap (2 pcs.), Phosphate High Range reagent starter kit (reagents for 20 tests), 1.5V AAA Alkaline battery (1 pc.), and instruction manual.</p>			
Reagent Set	<b>HI774-25</b> Reagents for 25 Marine Phosphate Ultra Low Range tests	<b>HI713-25</b> Reagents for 25 Phosphate Low Range tests	<b>HI7134-25</b> Reagents for 25 Phosphate Low Range tests	<b>HI717-25</b> Reagents for 40 Phosphate High Range tests
Calibration Set	<b>HI774-11</b> Marine Phosphate Ultra Low Range certified standard kit	<b>HI713-11</b> Phosphate Low Range certified standard kit	<b>HI7134-11</b> Phosphate Low Range certified standard kit	<b>HI717-11</b> Phosphate High Range certified standard kit

# Phosphorus

## Handheld Colorimeters

- Easier to use and more accurate than chemical test kits
- Dedicated to a single parameter
- Small size, big convenience
- Ideal for aquaculture

Plants, algae and phytoplankton require phosphorus for nourishment and utilize phosphorous as a component of cell tissue. When organic matter such as plant tissue, dead fish, algae, or uneaten food breaks down aerobically (with oxygen), phosphate is produced. This results in rapid oxygen depletion of aquarium water, which in turn suffocates aquatic life and compounds the problem.

Phosphorus concentration in water is monitored because it causes corrosion when present in levels too high.

Both the Hanna HI736 and HI706 Checker®HC's bridge the gap between simple chemical test kits and professional instrumentation. The Hanna HI736 (for marine applications) and HI706 (for fresh water applications) are both accurate and affordable.

The HI736 Checker HC portable handheld colorimeter features a resolution of 1 ppb and  $\pm 5$  ppb  $\pm 5\%$  of reading accuracy and uses an adaptation of the Ascorbic Acid.



SPECIFICATIONS	HI736 (Marine ULR)	HI706 (HR)
Range	0 to 200 ppb (as P)	0.0 to 15.0 ppm (as P)
Resolution	1 ppb	0.1 ppm
Accuracy	$\pm 5$ ppb $\pm 5\%$ of reading @ 25 °C (77 °F)	$\pm 0.3$ ppm $\pm 5\%$ of reading @ 25 °C (77 °F)
Light Source	Light Emitting Diode @ 525 nm	
Light Detector	Silicon photocell	
Method	Adaptation of the Standard Methods for the Examination of Water and Wastewater, 20th Edition, Ascorbic Acid Method. The reaction between phosphorus and the reagent causes a blue tint in the sample.	Adaptation of the Standard Methods for the Examination of Water and Wastewater, 18th Edition, Heteropolymolybdenum Blue Method. The reaction between reactive phosphorus and the reagent causes a blue tint in the sample.
Environment	0 to 50 °C (32 to 122 °F); max. 95% RH non-condensing	
Battery Type	1.5V AAA Alkaline	
Auto-off	After 10 minutes of non-use and 2 minutes after reading	
Dimensions	86.0 x 61.0 x 37.5 mm (3.4 x 2.4 x 1.5")	
Weight	64 g (2.3 oz)	
ORDERING INFORMATION	<p><b>HI736</b> Checker®HC is supplied with sample cuvette and cap (2 pcs.), Marine Phosphorus Ultra Low Range reagent starter kit (reagents for 6 tests), 1.5V AAA Alkaline battery (1 pc.) and instruction manual.</p> <p><b>HI706</b> Checker®HC is supplied with sample cuvette and cap (2 pcs.), Phosphorus High Range reagent starter kit (reagents for 20 tests), 1.5V AAA Alkaline battery (1 pc.), and instruction manual.</p>	
Reagent Set	<b>HI736-25</b> Reagents for 25 Phosphorus Ultra Low Range tests	<b>HI706-25</b> Reagents for 40 Phosphorus High Range tests
Calibration Set	<b>HI736-11</b> Phosphorus Ultra Low Range certified standard kit	<b>HI706-11</b> Phosphorus High Range certified standard kit

HI770 · HI705

## Silica High Range and Low Range

Handheld Colorimeter

- Easier to use and more accurate than chemical test kits
- Dedicated to a single parameter
- Small size, big convenience
- Ideal for:
  - Aquaculture
  - Water quality
  - Environmental
  - Water treatment

Silica is the name given to silicon dioxide, SiO<sub>2</sub>. Silicon (Si), is the most abundant element in the Earth's crust. Silicon is never found in its elemental form in nature. In its crystallized form it is only reactive under conditions of extremely high temperatures. Water and water vapor have little influence upon silicon solubility, because a protective surface layer of silicon dioxide is rapidly formed. Silicon binds with other elements to form various species of silica and silicate. The concentration of the soluble silica molecules are important to aquaculture because they influence (and limit) the growth of diatoms. In most waters, the predominant form of dissolved silica is monosilicic acid, which incorporates two water molecules.

The HI705 and HI770 Checker®HC Handheld Colorimeters are a simple, accurate, and cost effective way to measure silica. Each model is designed for a specific range (low or high) in order to provide high levels of accuracy.

The contoured style of these Checkers HC fit easily in the palm of your hand or pocket and the large LCD is easy to read. The auto shut-off feature assures the battery life will not be drained if you forget to turn it off.



SPECIFICATIONS	HI770 (HR)	HI705 (LR)
Range	0 to 200 ppm (as SiO <sub>2</sub> )	0.00 to 2.00 ppm (as SiO <sub>2</sub> )
Resolution	1 ppm	0.01 ppm
Accuracy	±2 ppm ±5% of reading @ 25 °C (77 °F)	±0.03 ppm ±5% of reading @ 25 °C (77 °F)
Light Source	Light Emitting Diode @ 470 nm	Light Emitting Diode @ 610 nm
Light Detector	Silicon photocell	
Method	Adaptation of the US EPA Method 370.1 and Standard Method 4500-SiO <sub>2</sub> C	Adaptation of the ASTM D859 Method of Heteropoly Blue Method. The reaction between silica and reagents causes a blue tint in the sample.
Environment	0 to 50 °C (32 to 122 °F); max. 95% RH non-condensing	
Battery Type	1.5V AAA Alkaline	
Auto-off	After 10 minutes of non-use	after three minutes of non-use and two minutes after reading
Dimensions	86.0 x 61.0 x 37.5 mm (3.4 x 2.4 x 1.5")	
Weight	64 g (2.3 oz)	
ORDERING INFORMATION	<p><b>HI770 Checker®HC</b> is supplied with sample cuvette and cap (2 pcs.), Silica High Range reagent starter kit (reagents for 6 tests), 1.5V AAA Alkaline battery (1 pc.), and instruction manual.</p> <p><b>HI705 Checker®HC</b> is supplied with sample cuvette and cap (2 pcs.), Silica Low Range reagent starter kit (reagents for 12 tests), 1.5V AAA Alkaline battery (1 pc.), and instruction manual.</p>	
Reagent Set	<b>HI770-25</b> Reagents for 25 Silica High Range tests	<b>HI705-25</b> Reagents for 25 Silica Low Range tests
Calibration Set	<b>HI770-11</b> Silica High Range certified standard kit	<b>HI705-11</b> Silica Low Range certified standard kit

Meter Code	Parameter	Chemical Method	Reagent Code	Certified Standard Kit	# of Tests
HI700	Ammonia LR	Nessler*	HI700-25	HI700-11	25
HI701 / HI7014	Chlorine, Free	DPD*	HI701-25/HI7014-25	HI701-11/HI7014-11	25
HI702 / HI7024	Copper HR	Bicinchoninate*	HI702-25/HI7024-25	HI702-11/HI7024-11	25
HI705	Silica LR	Heteropoly Blue*	HI705-25	HI705-11	25
HI706	Phosphorus HR	Amino Acid*	HI706-25	HI706-11	40
HI707	Nitrite LR	Diazotization*	HI707-25	HI707-11	25
HI708	Nitrite HR	Ferrous Sulfate*	HI708-25	HI708-11	25
HI709	Manganese HR	Periodate*	HI709-25	HI709-11	25
HI711	Chlorine, Total	DPD*	HI711-25	HI711-11	25
HI713 / HI7134	Phosphate LR	Ascorbic Acid*	HI713-25/HI7134-25	HI713-11/HI7134-11	25
HI715	Ammonia MR	Nessler*	HI715-25	HI715-11	25
HI716	Bromine	DPD*	HI716-25	HI716-11	25
HI717	Phosphate HR	Amino Acid*	HI717-25	HI717-11	40
HI718	Iodine	DPD*	HI718-25	HI718-11	25
HI719	Magnesium Hardness	EDTA*	HI719-25	HI719-11	25
HI720	Calcium Hardness	Calmagite*	HI720-25	HI720-11	25
HI721 / HI7214	Iron HR	Phenantroline*	HI721-25/HI7214-25	HI721-11/HI7214-11	25
HI723	Chromium VI HR	Diphenylcarbohydrazide*	HI723-25	HI723-11	25
HI726	Nickel HR	Photometric*	HI726-25	HI726-11	25
HI727	Color of Water	Colorimetric Platinum Cobalt*	-	HI727-11	-
HI729	Fluoride LR	SPADNS*	HI729-26	HI729-11	20
HI733	Ammonia HR	Nessler*	HI733-25	HI733-11	20
HI735	Total Hardness LR	USEPA 130.1*	HI735-25	HI735-11	25
HI736	Phosphorus, Marine ULR	Ascorbic Acid*	HI736-25	HI736-11	25
HI739	Fluoride HR	SPADNS*	HI739-26	HI739-11	30
HI746	Iron LR	TPTZ*	HI746-25	HI746-11	25
HI747	Copper LR	Bicinchoninate*	HI747-25	HI747-11	25
HI749	Chromium LR	Diphenylcarbohydrazide*	HI749-25	HI749-11	25
HI753	Chloride	Mercury(II) Thiocyanate	HI753-25	HI753-11	25
HI755	Alkalinity, Marine	Colorimetric	HI755-26	HI755-11	25
HI758	Calcium, Marine	Zincon*	HI758-26	HI758-11	25
HI761	Chlorine, Total ULR	DPD*	HI761-25	HI761-11	25
HI762	Chlorine, Free ULR	DPD*	HI762-25	HI762-11	25
HI764	Nitrite, Marine ULR	Diazotization*	HI764-25	HI764-11	25
HI767	Nitrite, Marine LR	Diazotization*	HI767-25	HI767-11	25
HI770	Silica HR	USEPA 370.1*/Std. Mtd. 4500-SiO <sub>2</sub> C*	HI770-25	HI770-11	25
HI771	Chlorine, Total UHR	4500-Cl*	HI771-25	HI771-11	25
HI772	Alkalinity, Marine	Colorimetric	HI772-26	HI772-11	25
HI774	Phosphate, Marine ULR	Ascorbic Acid*	HI774-25	HI774-11	25
HI775 / HI7754	Alkalinity	Colorimetric	HI775-26/HI7754-26	HI775-11/HI7754-11	25
HI779	pH	phenol red method	HI779-25	HI779-11	100
HI780	pH, Marine	phenol red method	HI780-25	HI780-11	100
HI781	Nitrate, Marine LR	colorimetric method	HI781-25	HI781-11	25
HI782	Nitrate, Marine HR	zinc reduction method	HI782-25	HI782-11	25
HI783	Magnesium, Marine	colorimetric method	HI783-25	HI783-11	25
HI784	Ammonia, Marine	salicylate method	HI784-25	HI784-11	25

\*adaptation

## Checker HC Accessories

Code	Description
HI731318	cuvette cleaning cloth (4)
HI731315	glass cuvettes and caps (2)
HI731321	glass cuvettes (4)
HI731225	cuvette cap for Checker®HC (4)
HI93703-50	cuvette cleaning solution, 250 mL
HI740226	5 mL graduated syringe
HI740157P	plastic refilling pipette (20)
HI740144P	pipette tip (10)
HI740143	1 mL graduated syringe (6)
HI740036P	100 mL plastic beaker (10)
HI70436M	deionized water (230 mL)
HI70436	deionized water (1G)

## Tips for an accurate measurement

It is important that the sample does not contain any debris.

Whenever the cuvette is placed into the measurement cell, it must be dry outside and completely free of fingerprints, oil or dirt. Wipe it thoroughly with HI731318 or a lint-free cloth prior to insertion.

Shaking the cuvette can generate bubbles, causing higher readings. To obtain accurate measurements, remove such bubbles by swirling or by gently tapping the cuvette.

Do not let the reacted sample stand for too long after reagent is added, or accuracy will be lost.

After the reading, it is important to discard the sample immediately, otherwise the glass might become permanently stained.

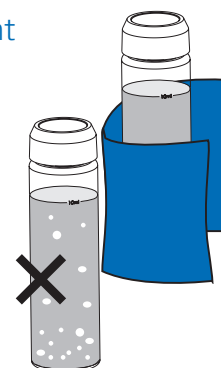

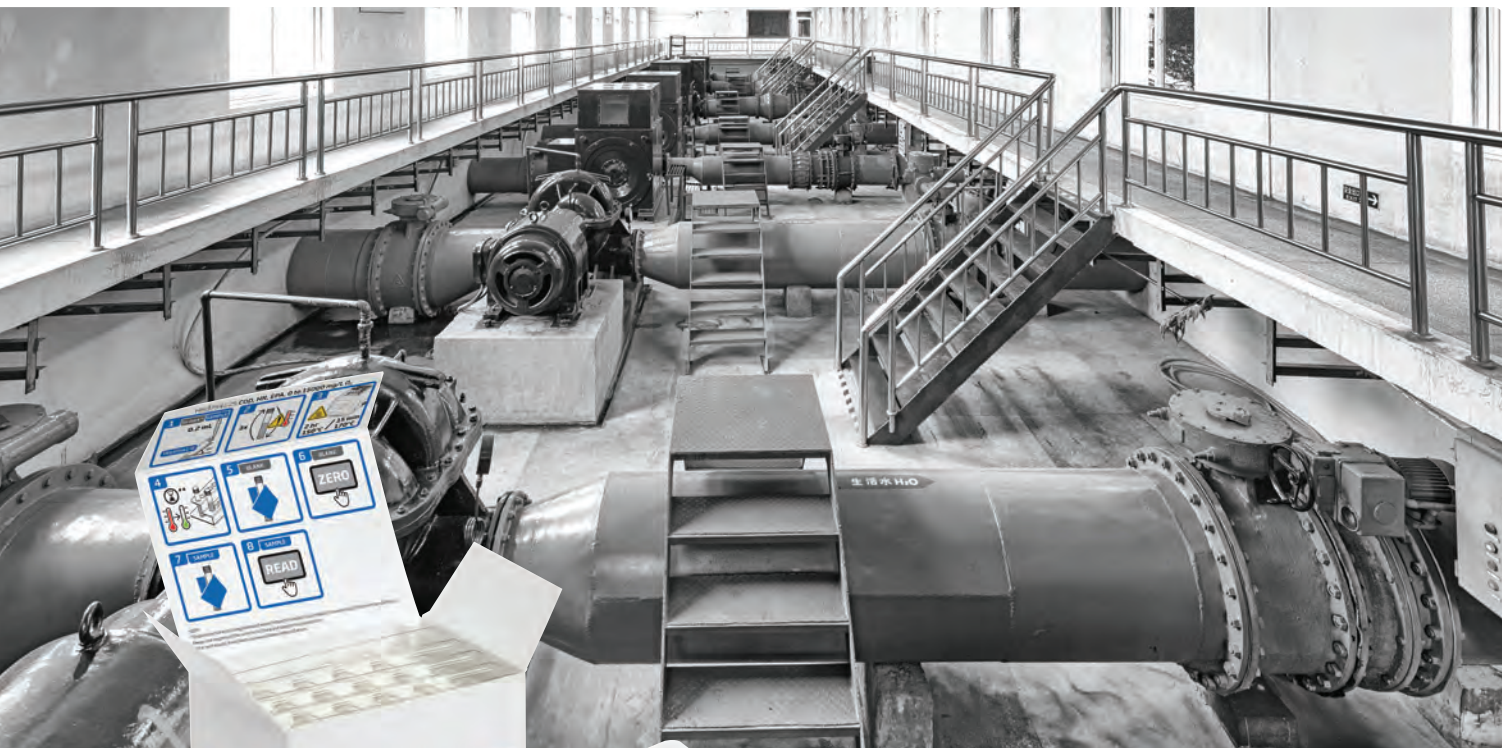

Introduction..... 11.2

Product Spotlights.....11.3

Benchtop ..... 11.4

COD with Bar Code Recognition ..... 11.4

COD with up to 83 methods ..... 11.6

COD for Wastewater Analysis ..... 11.14

Wastewater Testing Reagents.....11.18

Accessories .....11.19

Portable..... 11.20

Certified Reagents..... 11.22

Test Tube Heater ..... 11.24



Wastewater needs to be monitored closely to prevent environmental pollution and human illness.

## Oxygen Demand and COD

Chemical Oxygen Demand (COD) is a measure of the biologically available and inert organic matter that is susceptible to oxidation by a strong oxidizing agent.

The Hanna COD method is based on the well established closed dichromate-reflux colorimetric method. The colorimetric measurement of COD is faster and easier to perform than the titrimetric analysis; additional reagents are not required. The sample is added to the reagent vial and digested under closed reflux conditions and allowed to cool before measurement is taken. Reference standards can be made using potassium hydrogen phthalate (KHP), 1 mg of KHP is equal to 1.175 mg COD.

The US Environmental Protection Agency (EPA) specifies that the dichromate reflux method is the only method acceptable for reporting purposes. The advantage in using this method includes certifiable results as well as high accuracy.

## COD Testing Applications

COD is used as a measurement of pollutants. It is normally measured in both municipal and industrial wastewater treatment plants and gives an indication of the efficiency of the treatment process. COD is measured on both influent and effluent water. The efficiency of the treatment process is normally expressed as COD removal, measured as a percentage of the organic matter purified during the cycle. COD has further applications in power plant operations, chemical manufacturing, commercial laundries, pulp and paper mills, agriculture and animal waste runoff, environmental studies and general education. Hanna equipment can be used in the laboratory or for on-site testing. The measurement procedure has been designed for ease of use by personnel at any skill level.

*Wastewater monitoring examples:*

COD Influent	COD Effluent	COD Removal
1214	451	62%
948	328	63%
1341	307	77%

## Beyond COD: Nitrogen and Phosphorus

The goal in wastewater treatment is not only COD reduction, but also to control nitrogen and phosphorus, which are responsible for eutrophication phenomena in natural environments. COD, nitrogen, and phosphorus control are performed not only to obey environmental protection laws, but also to optimize plant costs.

Effective monitoring and control of parameters such as ammonia, nitrate, total nitrogen and total reactive phosphorus allow plant managers to profile and improve the health of aquatic ecosystems. By accurately monitoring levels of each specific pollutant, operational parameters can be adjusted to maintain high efficiency of biodegradation treatments while also minimizing costs.

## Nitrogen

When a treatment plant uses processes like nitrification and denitrification, it is important to monitor and maintain the equilibrium between ammonia nitrogen, nitrate and total nitrogen during the bio-treatment. The nitrogen level is important because it relates to the quantity of oxygen provided in the nitrification area. Ammonia is also controlled because it can become very toxic for the bacteria responsible for denitrification.

### Nitrification

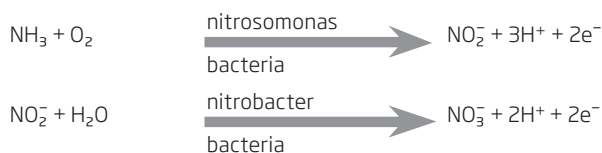

### Denitrification



## Phosphorus

Phosphorus is measured during both biological and chemical dephosphorization. An excessive amount of phosphate discharged in superficial waters or in bio-treatment tanks causes an increase of algae and system eutrophication.





HI83399

## Multiparameter Photometer with COD for Water and Wastewater

with Digital pH Electrode Input

HI83399 benchtop photometer measures 40 different key water and wastewater quality parameters using 77 different methods that allow for multiple ranges and variations in chemistry for specific applications. The Chemical Oxygen Demand (COD) parameter is included for industrial and municipal wastewater treatment. The Phosphorous and Nitrogen parameters included are beneficial to municipal wastewater treatment customers that need to monitor their biological and chemical nutrient removal process.

See page 11.6



HI83314

## Multiparameter Photometer with COD for Wastewater

with Digital pH Electrode Input

HI83314 benchtop photometer measures 10 different key wastewater quality parameters using 20 different methods that allow for multiple ranges and variations in chemistry for specific applications.

See page 11.14



HI93754

## COD Certified Standards and Reagents

Each box of 25 vials is supplied with a Hanna certificate of quality. The reagents are traceable to NIST SRM® 930.

- **Compact packaging**
  - Each set of COD vials is stored in fully recyclable, sustainable, compact plastic packaging rather than standard styrofoam. A smaller box allows you to store more on your shelf, and reduce waste when disposing of your packaging.

See page 11.22

HI83224

# COD Meter and Multiparameter Photometer

with Barcode Recognition of Sample Vials

From ammonia to phosphorus, the HI83224 benchtop photometer offers 15 measurement methods for different key water quality parameters in addition to chemical oxygen demand (COD) in 3 different ranges. The HI83224 features a barcode reader that can be used for barcoded sample vials. The reader scans each vial and automatically identifies the method and range, eliminating potential errors and simplifying the testing process.

This photometer features an advanced optical system that uses special tungsten lamps, narrow band interference filters, and silicon photodetectors to ensure accurate photometric readings every time. The HI83224 uses a graphic backlit LCD that allows for an intuitive user interface, offering a tutorial mode that gives a step-by-step procedure for performing a measurement. The result obtained can be displayed in various chemical forms based on the user's preference. For tracking of data, results can be logged and then exported to a Windows® compatible PC using the HI92000 software and HI920013 USB cable.

## Barcode Recognition

Automatic recognition of bar coded samples is an exciting feature of the HI83224. This advanced meter scans each vial inserted into the vial holder and automatically identifies the sample method and range. The barcode has four digits: the first two digits are for parameter identification and the second two digits are for reagent lot ID. Vials for different methods can be distinguished by a barcode printed on the vial and the cap color - the barcodes for different methods are shown in the table below. For parameters that don't use a barcoded reagent, the vials supplied with the instrument can be used.

## Vial Rotation

During the measurement phase of the analysis, the state-of-the-art vial rotator spins the vial to identify the method via the barcode, then rotates while taking a number of absorbance readings. The instrument then converts the readings to concentration units and displays the result on the easy to read screen.



Application Designed Photometers



- **Improved Accuracy**
  - Using the “average” function further improves reading accuracy. When enabled in the setup menu, the instrument takes 180 absorbance readings through the vial as it rotates. Each individual reading represents a measurement through a new optical path. Averaging the absorbance readings minimizes errors due to vial inconsistencies.
- **Method Verification**
  - A dedicated METHOD CHECK button is available to verify the vial barcode, eliminating the potential for vial confusion or incorrect sample readings.
- **Backlit Graphic LCD Display**
  - The HI83224 features an adjustable backlit graphic display with virtual keys and on-screen help to provide for an intuitive user interface.
- **Data Logging**
  - Users can store up to 200 readings by simply pressing the LOG key. Logged readings are just as easily recalled by pressing the dedicated RCL button. Stored data includes parameter, test results, sample number, lot number, instrument ID, date and time.
- **PC Connectivity**
  - Logged readings can be transferred to a PC via USB using HI92000 Windows® compatible software.
- **Result Conversion**
  - Eliminates confusion by automatically converting readings to other chemical forms. Common conversions are available at the touch of a button.
- **On-screen Tutorial**
  - With the tutorial function enabled, short guides relating to the current operation are displayed.
- **Built-in Timer**
  - Display of time remaining before a measurement is taken. Ensures that all readings are taken at the appropriate reaction intervals for the test being performed.
- **Error Messages**
  - Messages on display alerting to problems including barcode error, wrong vial, and different reagent lot.
- **Cooling Lamp Indicator**
  - To maintain the desirable wavelength to be used for absorbance, it is necessary to ensure components are not overheated from the heat generated by the tungsten lamp. Each photometer is designed to allow a minimal amount of time for components to cool.

## Specifications HI83224

Light Life	Life of the instrument
Light Detector	Silicon Photocell
Data Logging	up to 200 samples
PC Connectivity	USB
Environment	0 to 50 °C (32 to 122 °F); max 90% RH non-condensing
Power Supply	230 VAC or 115 VAC
Dimensions	235 x 212 x 143 mm (9.2 x 8.34 x 5.62")
Weight	2.3 kg (5.1 lb)

**Ordering Information** **HI83224-01** (115V) and **HI83224-02** (230V) are supplied with sample vials (10), cloth for wiping vials (1 pcs.), scissors, and instruction manual.



- Bar code reader detects the method and range automatically

### HI83224 Parameter Specifications

Parameter	Range	Resolution	Accuracy	Wavelength	Method	Reagent Code
Ammonia Low Range	0.00 to 3.00 mg/L (as NH <sub>3</sub> -N)	0.01 mg/L	±0.10 mg/L ±5% of reading at 25 °C	420 nm	Adaptation of the ASTM Manual of Water and Environmental Technology, D1426 Nessler Method	<b>HI94764A-25</b> (25 tests)
Ammonia High Range	0 to 100 mg/L (as NH <sub>3</sub> -N)	1 mg/L	±1 mg/L or ±5 % of reading @ 25 °C, whichever is greater	420 nm	Adaptation of the ASTM Manual of Water and Environmental Technology, D1426 Nessler Method	<b>HI94764B-25</b> (25 tests)
Chlorine, Free	0.00 to 5.00 mg/L (as Cl <sub>2</sub> )	0.01 mg/L	±0.03 mg/L ±4% of reading at 25 °C whichever is greater	525 nm	Adaptation of the EPA method 330.5 and Standard Methods for the Examination of Water and Wastewater, 20th edition, 4500-Cl G, DPD method.	<b>HI93701-01</b> Reagents for 100 tests (powder) <b>HI93701-03</b> Reagents for 300 tests (powder)
Chlorine, Total	0.00 to 5.00 mg/L (as Cl <sub>2</sub> )	0.01 mg/L	±0.03 mg/L ±4% of reading at 25 °C whichever is greater	525 nm	Adaptation of the EPA method 330.5 and Standard Methods for the Examination of Water and Wastewater, 20th edition, 4500-Cl G, DPD method.	<b>HI93711-01</b> Reagents for 100 total tests (powder) <b>HI93711-03</b> Reagents for 300 total tests (powder)
Chemical Oxygen Demand Low Range 150 °C, 2 hours	0 to 150 mg/L (as O <sub>2</sub> )	1 mg/L	±5 mg/L or ±5% of reading at 25 °C, whichever is greater	420 nm	dichromate EPA† dichromate mercury-free ◊ dichromate ISO ◊	<b>HI94754A-25</b> Reagents EPA (24 tests) <b>HI94754D-25</b> Reagents Hg Free (24 tests) <b>HI94754F-25</b> Reagents ISO (24 tests)
Chemical Oxygen Demand Medium Range 150 °C, 2 hours	0 to 1500 mg/L (as O <sub>2</sub> )	1 mg/L	±15 mg/L or ±4% of reading at 25 °C, whichever is greater	610 nm	dichromate EPA† dichromate mercury-free ◊ dichromate ISO ◊	<b>HI94754B-25</b> Reagents EPA (24 tests) <b>HI94754E-25</b> Reagents Hg Free (24 tests) <b>HI94754G-25</b> Reagents ISO (24 tests)
Chemical Oxygen Demand High Range 150 °C, 2 hours	0 to 15000 mg/L (as O <sub>2</sub> )	10 mg/L	±150 mg/L or ±3% of reading at 25 °C, whichever is greater	610 nm	dichromate	<b>HI94754C-25</b> Reagents for 24 tests

**COD Rapid Method: It is now possible to get results for process control monitoring in a fraction of the time using any of the Hanna COD reagents. The Rapid Method digestion time is reduced from 2 hours to 15 minutes when the digestion temperature is increased from 150 °C to 170 °C.**

Chemical Oxygen Demand Low Range/ Rapid Method 170 °C, 15 minutes	0 to 150 mg/L (as O <sub>2</sub> ) 0 to 1500 mg/L 0 to 1500 mg/L	1 mg/L	±8 mg/L or ±5% of reading at 25 °C, whichever is greater	420 nm	adaptation of dichromate EPA adaptation of dichromate mercury-free adaptation of dichromate ISO	<b>HI94754A-25</b> Reagents EPA (24 tests) <b>HI94754D-25</b> Reagents Hg Free (24 tests) <b>HI94754F-25</b> Reagents ISO (24 tests)
Chemical Oxygen Demand Medium Range/ Rapid Method 170 °C, 15 minutes	0 to 150 mg/L (as O <sub>2</sub> ) 0 to 1500 mg/L 0 to 1500 mg/L	1 mg/L	±20 mg/L or ±4% of reading at 25 °C, whichever is greater	610 nm	adaptation of dichromate EPA adaptation of dichromate mercury-free adaptation of dichromate ISO	<b>HI94754B-25</b> Reagents EPA (24 tests) <b>HI94754E-25</b> Reagents Hg Free (24 tests) <b>HI94754G-25</b> Reagents ISO (24 tests)
Nitrate	0.0 to 30.0 mg/L (as NO <sub>2</sub> <sup>-</sup> -N)	0.1 mg/L	±1.0 mg/L or ±5% of reading at 25 °C, whichever is greater	420 nm	Chromotropic Acid Method	<b>HI94766-50</b> Reagents for up to 50 tests
Nitrogen, Total Low Range	0.0 to 25.0 mg/L (as N)	0.1 mg/L	±1.0 mg/L or ±5% of reading at 25 °C, whichever is greater	420 nm	Chromotropic Acid Method	<b>HI94767A-50</b> Reagents for up to 49 tests
Nitrogen, Total High Range	10 to 150 mg/L (as N)	1 mg/L	±3 mg/L or ±4% of reading at 25 °C, whichever is greater	420 nm	Chromotropic Acid Method	<b>HI94767B-50</b> Reagents for up to 49 tests
Phosphorus, Acid Hydrolyzable (13 mm Vial)	0.00 to 1.60 mg/L (as P)	0.01 mg/L	±0.05 mg/L or ±5% of reading at 25 °C, whichever is greater	610 nm	Adaptation of the EPA method 365.2 and Standard Methods for the Examination of Water and Wastewater, 20th Edition, 4500-P E, Ascorbic Acid Method	<b>HI94758B-50</b> (50 tests)
Phosphorus, Reactive Low Range	0.00 to 1.60 mg/L (as P)	0.01 mg/L	±0.05 mg/L or ±5% of reading at 25 °C, whichever is greater	610 nm	Adaptation of the EPA method 365.2 and Standard Methods for the Examination of Water and Wastewater, 20th Edition, 4500-P E, Ascorbic Acid Method	<b>HI94758A-50</b> (50 tests)
Phosphorus, Reactive High Range	0.0 to 32.6 mg/L (as P)	0.1 mg/L	±0.5 mg/L or ±5% of reading at 25 °C, whichever is greater	420 nm	Adaptation of the Standard Methods for the Examination of Water and Wastewater, 20th Edition, 4500-P C, Vanadomolybdophosphoric Acid Method	<b>HI94763A-50</b> (49 tests)
Phosphorus, Total Low Range	0.00 to 1.15 mg/L (as P)	0.01 mg/L	±0.05 mg/L or ±6% of reading at 25 °C, whichever is greater	610 nm	Adaptation of the EPA method 365.2 and Standard Methods for the Examination of Water and Wastewater, 20th Edition, 4500-P E, Ascorbic Acid Method	<b>HI94758C-50</b> (50 tests)
Phosphorus, Total High Range	0.0 to 32.6 mg/L (as P)	0.1 mg/L	±0.5 mg/L or ±5% of reading at 25 °C, whichever is greater	420 nm	Adaptation of the Standard Methods for the Examination of Water and Wastewater, 20th Edition, 4500-P C, Vanadomolybdophosphoric Acid Method	<b>HI94763B-50</b> (49 tests)

**Notes:**

- † Method with chromium-sulfuric acid is officially recognized by EPA for wastewater analysis.
- ◊ The HI94754F-25 and HI94754G-25 method follows the official method ISO 15705.
- ◊◊ This method is recommended for general purpose analysis with no chloride interference.

HI83399

# Multiparameter Photometer with COD for Water and Wastewater

with Digital pH Electrode Input

HI83399 benchtop photometer measures 40 different key water and wastewater quality parameters using 77 different methods that allow for multiple ranges and variations in chemistry for specific applications. The Chemical Oxygen Demand (COD) parameter is included for industrial and municipal wastewater treatment. The Phosphorous and Nitrogen parameters included are beneficial to municipal wastewater treatment customers that need to monitor their biological and chemical nutrient removal process. This photometer features an innovative optical system that uses LEDs, narrow band interference filters, focusing lens and both a silicon photodetector for absorbance measurement and a reference detector to maintain a consistent light source ensures accurate and repeatable photometric readings every time.

To save valuable laboratory benchtop space, the HI83399 doubles as a professional pH meter with its digital pH/temperature electrode input. Now one meter can be used for both photometric and pH measurements.

- **Water and wastewater treatment digestion parameters**
  - Allows measurement of COD, Total Nitrogen and Total Phosphorus
- **Advanced optical system**
  - Innovative optical design that utilizes a reference detector and focusing lens to eliminate errors from changes in the light source and from imperfections in the glass cuvette.
- **Backlit 128 x 64 Pixel Graphic LCD Display**
  - Backlit graphic display allows for easy viewing in low light conditions
  - The 128 x 64 Pixel LCD allows for a simplified user interface with virtual keys and on-screen help to guide the user through use of the meter
- **Built-in Reaction Timer for Photometric Measurements**
  - The measurement is taken after the countdown timer expires.



- Countdown timer ensures that all readings are taken at the appropriate reaction intervals regardless of user for better consistency in measurements
- **Absorbance mode**
  - Hanna's exclusive CAL Check cuvettes for validation of light source and detector
  - Allows for the user to plot concentration versus absorbance for a specific wavelength for use with user supplied chemistry or for teaching principles of photometry
- **Units of Measure**
  - Appropriate unit of measure along with chemical form is displayed along with reading
- **Result Conversion**
  - Automatically convert readings to other chemical forms with the touch of a button
- **Cuvette Cover**
  - Aids in preventing stray light from affecting measurements
- **Digital pH Electrode Input**
  - Measure pH and temperature with a single probe
  - Good Laboratory Practice (GLP) to track calibration information including date, time, buffers used, offset and slope for traceability
- pH CAL Check alerts user to potential problems during the calibration process
- Space saving having a pH meter and photometer built into one meter
- **Data Logging**
  - Up to 1000 photometric and pH readings can be stored by simply pressing the dedicated LOG button. Logged readings are just as easily recalled by pressing the RCL button
  - Sample ID and User ID information can be added to a logged reading using alphanumeric keypad
- **Connectivity**
  - Logged readings can be quickly and easily transferred to a flash drive using the USB-A host port or to a computer using the micro USB-B port
  - Data is exported as a .CSV file for use with common spreadsheet programs
- **Rechargeable Battery**
  - Li-polymer rechargeable battery lasts for 500 measurements or 50 hours of pH measurement
- **Battery Status Indicator**
  - Indicates the amount of battery life left
- **Error Messages**
  - Photometric error messages
  - pH calibration messages include clean electrode, check buffer and check probe

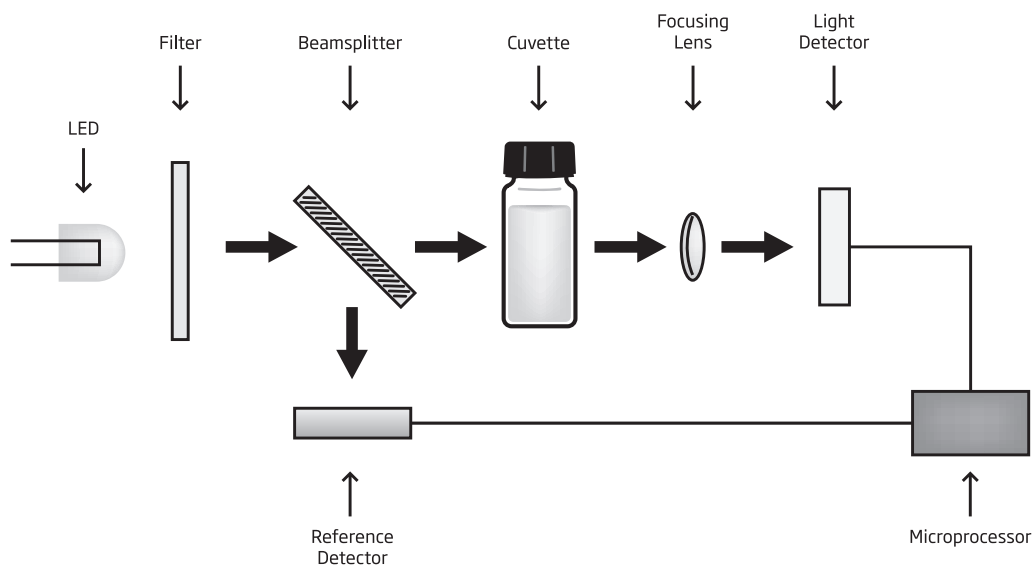

## Improved Optical System

HI83300 family is designed with an innovative optical system that incorporates a beam splitter so that light can be used for absorbance readings and for a reference detector. The reference detector monitors the intensity of light and modulates when there is drift due to power fluctuation or the heating of the optical components. Each part has an important role in providing unparalleled performance from a photometer.

## High Efficiency LED Light Source

An LED light source offers superior performance as compared to a tungsten lamp. LEDs have a much higher luminous efficiency, providing more light while using less power. They also produce very little heat, which could otherwise affect the optical components and electronic stability.

## Quality Narrow Band Interference Filters

The narrow band interference filter not only ensures greater wavelength accuracy ( $\pm 1$  nm) but is also extremely efficient, allowing a brighter, stronger signal to be transmitted. The end result is increased measurement stability and less wavelength error.

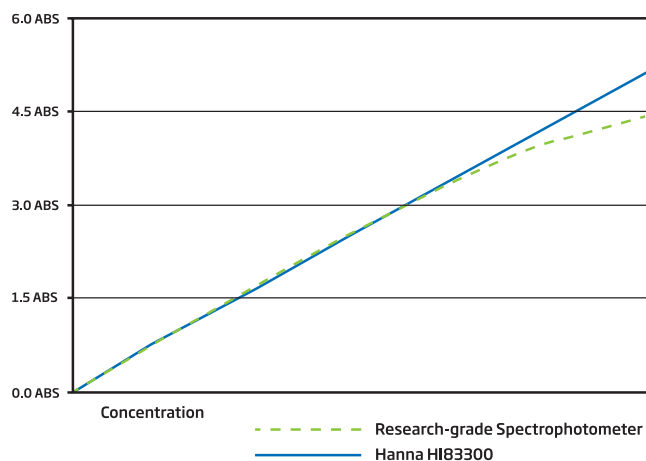

- Better linearity than research-grade spectrophotometers

## Reference Detector for a Stable Light Source

A beam splitter is used as part of the internal reference system of the HI83300 photometer. The reference detector compensates for any drift due to power fluctuations or ambient temperature changes. Now you can rely on a stable source of light.

## Large Cuvette Size

The sample cell of the HI83300 fits a round, glass cuvette with a 25 mm path length. Along with the advanced optical components, the larger size of the cuvette greatly reduces errors in rotation from the indexing mark of the cuvettes. The relatively long path length of the sample cuvette allows the light to pass through more of the sample solution, ensuring accurate measurements even in low absorbance samples.

## Focusing Lens for Greater Light Yield

Adding a focusing lens to the optical path allows for the collection of all of the light that exits the cuvette and focusing the light on the silicon photo detector. This innovative approach to photometric measurements cancels the errors from imperfections and scratches present in the glass cuvette eliminating the need to index the cuvette.

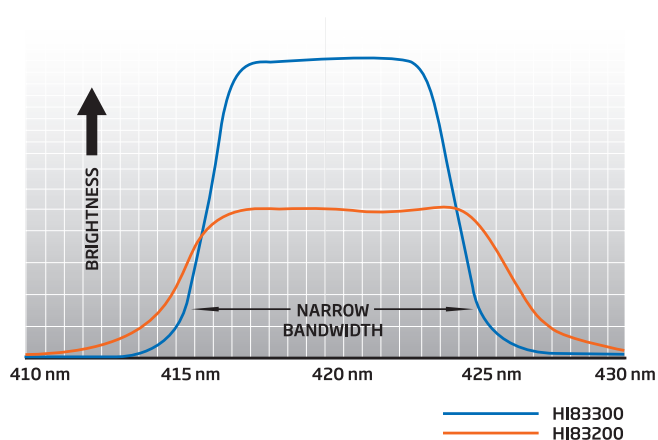

- Improved optical filters – higher wavelength accuracy and light throughput



## Cuvette Adapter

The HI83399 is supplied with a 16 mm cuvette adapter that accepts digestion vials.



## Digestion Vial Methods

Compatible with COD (EPA, ISO, and mercury free methods), Nitrogen and Phosphorous reagents packaged in 16 mm digestion vial. Reagents are sold separately.



## COD Reactor for Digestion Vials

A COD reactor is used to heat the digestion vials. The digestion vials must be heated to a specific temperature for a period of time making the HI839800 an important accessory required to have a complete wastewater treatment monitoring system. HI839800 sold separately.

## Connectivity



### ① pH Connectivity

Any of our digital pH electrodes can be connected to the HI83300 family by a 3.5 mm input. Plugging in an electrode has never been easier; there are no alignment issues or broken pins. Simply connect the electrode and start taking measurements.

### ② Dual Power Supply

The HI83399 is equipped with a rechargeable lithium ion battery that lasts up to 500

photometer measurements or 50 hours of continuous pH measurements. A power supply can also be plugged into the micro USB port at the back of the meter.

### ② ③ USB Connectivity

Both a USB and micro USB port are located on the HI83399. Each of these ports can be used to transfer data via flash drive or direct connection to a PC or MAC. Data is transferred as CSV files for easy processing and widespread compatibility.

## Photometer Capabilities

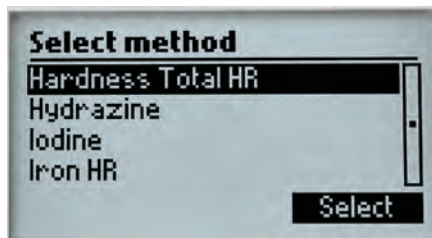

### Concentration Measurement Function

Users can access the menu of measurement methods with the simple press of a button. Low, medium, and high range methods of several parameters are available for users to obtain a high accuracy reading. Each method is assigned a concentration unit of measure. Parameters can be expressed in different chemical forms based on their preference.

### CAL Check Functionality

Hanna's exclusive CAL Check feature allows for performance verification of the independent measuring channels. Our CAL Check standard vials are developed to simulate a specific absorbance value at each wavelength to verify its accuracy.

### Built-in Reaction Timer

Reaction time is of key importance when performing colorimetric measurements, which is why the built-in timer of the HI83300 is an ideal feature. The countdown timer displays the time remaining until a measurement will be taken, ensuring consistent results between measurements and users.

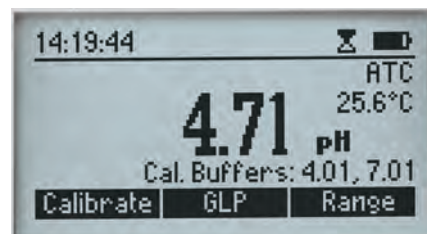

### pH Measurement

The HI83300 family offers the ability to connect a digital pH electrode. Users can connect any sensor from our extensive line of digital pH electrodes. Whether a user requires a glass or plastic body, a spheric or conic tip shape, or the ability for safe use with food samples, our digital electrode offering is suitable for nearly everyone.



### Large Cuvettes

The sample cell of these meters fits a round, glass cuvette with a 25 mm path length. The relatively long path length of the sample cuvette allows the light to pass through more of the sample solution, ensuring accurate measurements even in low absorbance samples. This cuvette size also provides a larger opening, making it easier for users to dispense ready-made liquid or powder reagents into the sample.

An affixed, light-blocking cover panel closes over the sample cell, reducing stray light from affecting any measurement readings.



### Absorbance Measurement Mode

Users can select to calibrate and measure samples in absorbance mode for each wavelength used by the meter. This mode is a convenient way for users to develop their own calibration curves and measure samples with customized chemistries.

## Data Management Capabilities

### User ID and Sample ID

An alphanumeric keypad can be used to enter sample ID and user ID to be stored with the measurement reading. The recall key allows the user to review the data along with the date and time that the reading was taken.

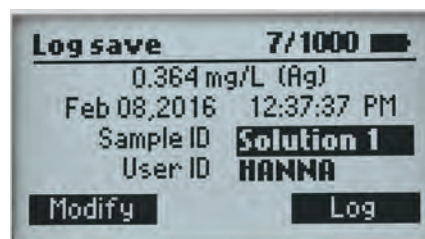

### Data Management

The HI83399 can store up to 1000 photometer and pH electrode readings, which can be logged by pressing the LOG key on the face of the meter. pH readings are logged along with comprehensive GLP (Good Laboratory Practice) information such as date, time, calibration buffers, and electrode offset and slope.

### USB for Data Transfer

Two USB ports are provided for transferring data. One port allows the data to be transferred to a flash drive while the other USB is used for direct connection to a computer. All data is transferred as a .csv file that can be used with many spreadsheet programs for documentation.

## Display Features

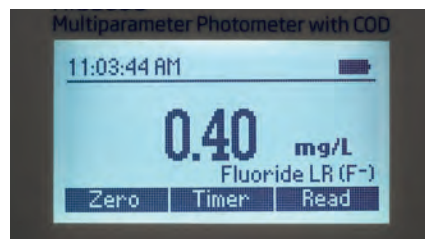

### Backlit Graphic LCD Display

A backlit, graphic LCD display provides an easy to read, user-friendly interface.

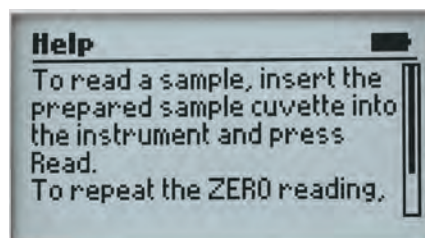

### Intuitive Display

With virtual keys, a battery status indicator, and practical error messages, users will find the meter interface intuitive. On-screen guides provide information relating to the current meter operation, and can be used at any stage in the setup or measurement process to show contextual help.

## Specifications

Measurement Channels	5 x optical channels 1 x digital electrode channel (pH measurement)	
Photometer	Range	0.000 to 4.000 Abs
	Resolution	0.001 Abs
	Accuracy	0.003 Abs @ 1.000 Abs
	Light Source	Light Emitting Diode
	Bandpass Filter Bandwidth	8 nm
	Bandpass Filter Wavelength Accuracy	± 1.0 nm
	Light Detector	Silicon photocell
	Cuvette Types	Round, 24.6mm & 16mm diameter
Probe	Number of Methods	90
	Range	-2.00 to 16.00 pH (± 1000.0 mV)*
	Resolution	0.01 pH (0.1 mV)
	Accuracy	±0.01 pH (±0.2 mV) @ 25°C (77°F)
	Temperature Compensation	ATC, -5.0 to 100.0°C (23.0 to 212.0°F)*
	Calibration	two-point, from five available buffers (4.01, 6.86, 7.01, 9.18, 10.01 pH)
Temperature	Electrode	Intelligent pH / temperature electrode
	Range	-20 to 120°C (-4.0 to 248.0 °F)
	Resolution	0.1 °C (0.1 °F)
Additional Specifications	Accuracy	±0.5°C @ 25°C (±0.9°F @ 77°F)
	Logging	1000 readings (mixed photometer and electrode)
	Display	128 x 64 pixel B/W LCD with backlight
	USB-A (Host) functions	Mass-storage host
	USB-B (Device) functions	Power input, mass-storage device
	Battery Life	> 500 photometer measurements or 50 hours of continuous pH measurement
	Power Supply	5 Vdc USB 2.0 power adapter / type micro-Bconnector 3.7 Vdc Li-polymer rechargeable battery, non-serviceable
	Environment	0 to 50°C (32 to 122°F) 0 to 95% RH, non-serviceable
	Dimensions	206 x 177 x 97mm (8.1 x 7.0 x 3.8")
	Weight	1.0 kg (2.2 lbs.)
Ordering Information	<b>HI83399-01</b> (115V) and <b>HI83399-02</b> (230V) is supplied with sample cuvette (4 pcs.), sample cuvette cap (4 pcs.), cloth for wiping cuvettes, scissors, USB cable, 5 Vdc power adapter, 16mm vial adapter, 16mm diameter vial with cap (6 pcs.), 60mL glass bottle, instrument quality certificate, and instruction manual.	
Standards	<b>HI83399-11</b> CAL Check Cuvette Kit for HI83399	

\*Limits will be reduced to actual probe / sensor limits.

## HI83399 Parameter Specifications

Parameter	Range	Resolution	Accuracy	Wavelength	Method	Reagent Code
Alkalinity	0 to 500 mg/L (as CaCO <sub>3</sub> )	1 mg/L	±5 mg/L ±5% of reading at 25 °C	610 nm	Bromocresol Green	<b>HI775-26</b> Reagents for 25 tests
Alkalinity, Marine	0 to 300 mg/L (as CaCO <sub>3</sub> )	1 mg/L	±5 mg/L ±5% of reading at 25 °C	610 nm	Bromocresol Green	<b>HI755-26</b> Reagents for 25 tests
Aluminum	0.00 to 1.00 mg/L (as Al <sup>3+</sup> )	0.01 mg/L	±0.04 mg/L ±4% of reading at 25 °C	525 nm	Adaptation of the Aluminon Method	<b>HI93712-01</b> Reagents for 100 tests
						<b>HI93712-03</b> Reagents for 300 tests
Ammonia Low Range	0.00 to 3.00 mg/L (as NH <sub>3</sub> -N)	0.01 mg/L	±0.04 mg/L ±4% of reading at 25 °C	420 nm	Adaptation of the ASTM Manual of Water and Environmental Technology, D1426 Nessler Method	<b>HI93700-01</b> Reagents for 100 tests <b>HI93700-03</b> Reagents for 300 tests
Ammonia Low Range (13 mm Vial)	0.00 to 3.00 mg/L (as NH <sub>3</sub> -N)	0.01 mg/L	± 0.10 mg/L or ± 5% of reading at 25 °C, whichever is greater	420 nm	Adaptation of the ASTM Manual of Water and Environmental Technology, D1426 Nessler Method	<b>HI93764A-25</b> Reagents for 25 tests
Ammonia Medium Range	0.00 to 10.00 mg/L (as NH <sub>3</sub> -N)	0.01 mg/L	± 0.05 mg/L ± 5% of reading at 25 °C, whichever is greater	420 nm	Adaptation of the ASTM Manual of Water and Environmental Technology, D1426, Nessler Method	<b>HI93715-01</b> Reagents for 100 tests <b>HI93715-03</b> Reagents for 300 tests
Ammonia High Range	0.0 to 100.0 mg/L (as NH <sub>3</sub> -N)	0.1 mg/L	±0.5 mg/L ± 5% of reading at 25 °C	420 nm	Adaptation of the ASTM Manual of Water and Environmental Technology, D1426, Nessler Method	<b>HI93733-01</b> Reagents for 100 tests <b>HI93733-03</b> Reagents for 300 tests
Ammonia High Range (13 mm Vial)	0.0 to 100.0 mg/L (as NH <sub>3</sub> -N)	0.1 mg/L	± 1.0 mg/L or ± 5% of reading at 25 °C, whichever is greater	420 nm	Adaptation of the ASTM Manual of Water and Environmental Technology, D1426 Nessler Method	<b>HI93764B-25</b> Reagents for 25 tests
Bromine	0.00 to 8.00 mg/L (as Br <sub>2</sub> )	0.01 mg/L	±0.08 mg/L ±3% of reading at 25 °C	525 nm	Adaptation of the Standard Methods for the Examination of Water and Wastewater, 18th Edition, DPD Method	<b>HI93716-01</b> Reagents for 100 tests <b>HI93716-03</b> Reagents for 300 tests
Calcium	0 to 400 mg/L (as Ca <sup>2+</sup> )	1 mg/L	±10 mg/L ±5% of reading at 25 °C	466 nm	Adaptation of the Oxalate Method	<b>HI937521-01</b> Reagents for 50 tests <b>HI937521-03</b> Reagents for 150 tests
Calcium, Marine	200 to 600 mg/L (as Ca <sup>2+</sup> )	1 mg/L	±6% of reading at 25 °C	610 nm	Adaptation of the Zincon Method	<b>HI758-26</b> Reagents for 25 tests
Chloride	0.0 to 20.0 mg/L (as Cl <sup>-</sup> )	0.1 mg/L	±0.5 mg/L ±6% of reading at 25 °C	466 nm	Adaptation of the Mercury (II) Thiocyanate Method	<b>HI93753-01</b> Reagents for 100 tests <b>HI93753-03</b> Reagents for 300 tests
Chlorine Dioxide	0.00 to 2.00 mg/L (as ClO <sub>2</sub> )	0.01 mg/L	±0.10 mg/L ±5% of reading at 25 °C	575 nm	Adaptation of the Chlorophenol Red Method	<b>HI93738-01</b> Reagents for 100 tests <b>HI93738-03</b> Reagents for 300 tests
Chlorine Dioxide (Rapid)	0.00 to 2.00 mg/L (as ClO <sub>2</sub> )	0.01 mg/L	±0.10 mg/L ±5% of reading at 25 °C	525 nm	Adaptation of Standard Methods for the Examination of Water and Wastewater, 18th Edition, 4500 ClO <sub>2</sub> D	<b>HI96779-01</b> Reagents for 100 tests <b>HI96779-03</b> Reagents for 300 tests



Parameter	Range	Resolution	Accuracy	Wavelength	Method	Reagent Code
Chlorine, Free Ultra Low Range	0.000 to 0.500 mg/L (as Cl <sub>2</sub> )	0.001 mg/L	±0.020 mg/L ±3% of reading at 25 °C	525 nm	Adaptation of the Standard Method 4500-Cl <sub>G</sub>	<b>HI95762-01</b> Reagents for 100 tests <b>HI95762-03</b> Reagents for 300 tests
Chlorine, Free	0.00 to 5.00 mg/L (as Cl <sub>2</sub> )	0.01 mg/L	±0.03 mg/L ±3% of reading at 25 °C	525 nm	Adaptation of the EPA DPD Method 330.5	<b>HI93701-F</b> Reagents for 300 tests (liquid) <b>HI93701-01</b> Reagents for 100 tests (powder) <b>HI93701-03</b> Reagents for 300 tests (powder)
Chlorine, Total Ultra Low Range	0.000 to 0.500 mg/L (as Cl <sub>2</sub> )	0.001 mg/L	±0.020 mg/L ±3% of reading at 25 °C	525 nm	Adaptation of the EPA DPD Method 330.5	<b>HI95761-01</b> Reagents for 100 tests <b>HI95761-03</b> Reagents for 300 tests
Chlorine, Total	0.00 to 5.00 mg/L (as Cl <sub>2</sub> )	0.01 mg/L	±0.03 mg/L ±3% of reading at 25 °C	525 nm	Adaptation of the EPA DPD Method 330.5	<b>HI93701-T</b> Reagents for 300 tests (liquid) <b>HI93711-01</b> Reagents for 100 total tests (powder) <b>HI93711-03</b> Reagents for 300 total tests (powder)
Chlorine, Total Ultra High Range	0 to 500 mg/L (as Cl <sub>2</sub> )	1 mg/L	±3 mg/L ±3% of reading at 25 °C	525 nm	Adaptation of the Standard Methods for Examination of Water and Wastewater, 20th Edition, 4500-Cl	<b>HI95771-01</b> Reagents for 100 tests <b>HI95771-03</b> Reagents for 300 tests
Chromium (VI) Low Range	0 to 300 µg/L (as Cr(VI))	1 µg/L	±10 µg/L ±4% of reading at 25 °C	525 nm	Adaptation of the ASTM Manual of Water and Environmental Technology, D1687 Diphenylcarbohydrazide Method	<b>HI93749-01</b> Reagents for 100 tests <b>HI93749-03</b> Reagents for 300 tests
Chromium (VI) High Range	0 to 1000 µg/L (as Cr(VI))	1 µg/L	±5 µg/L ±4% of reading at 25 °C	525 nm	Adaptation of the ASTM Manual of Water and Environmental Technology, D1687-92, Diphenylcarbohydrazide Method	<b>HI93723-01</b> Reagents for 100 tests <b>HI93723-03</b> Reagents for 300 tests
Chromium (VI)/Total (13 mm Vial)	0 to 1000 µg/L (as Cr)	1 µg/L	±10 µg/L ±3% of reading	525 nm	Adaptation of the Standard Methods of the Examination of Water and Wastewater, 22nd Edition, 3500-Cr, Diphenylcarbazide Method	<b>HI96781-25</b> Reagents for 25 tests
Chemical Oxygen Demand Low Range (13 mm Vial)	0 to 150 mg/L (as O <sub>2</sub> )	1 mg/L	±5 mg/L or ±4% of reading at 25 °C, whichever is greater	420 nm	Adaptation of the EPA 410.4 Approved Method for the COD Determination on Surface Waters and Wastewaters	<b>HI93754A-25</b> Reagents EPA Low Range for 24 tests <b>HI93754D-25</b> Reagents Hg Free Low Range for 24 tests <b>HI93754F-25</b> Reagents ISO Low Range for 24 tests
Chemical Oxygen Demand Medium Range (13 mm Vial)	0 to 1500 mg/L (as O <sub>2</sub> )	1 mg/L	±15 mg/L or ±4% of reading at 25 °C, whichever is greater	610 nm	Adaptation of the EPA 410.4 Approved Method for the COD Determination on Surface Waters and Wastewaters	<b>HI93754B-25</b> Reagents EPA Medium Range for 24 tests <b>HI93754E-25</b> Reagents Hg Free Medium Range for 24 tests <b>HI93754G-25</b> Reagents ISO Medium Range for 24 tests
Chemical Oxygen Demand High Range EPA (13 mm Vial)	0 to 15000 mg/L (as O <sub>2</sub> )	1 mg/L	±150 mg/L or ±2% of reading at 25 °C, whichever is greater	610 nm	Adaptation of the EPA 410.4 Approved Method for the COD Determination on Surface Waters and Wastewaters	<b>HI93754C-25</b> Reagents for 24 tests
Chemical Oxygen Demand Ultra High Range (13 mm Vial)	0.0 to 60.0 ppt (as O <sub>2</sub> )	0.1 ppt	±0.5 ppt ±3% of reading @ 25°C	610 nm	Adaptation of the EPA 410.4 Approved Method for the COD Determination on Surface Waters and Wastewaters	<b>HI93754J-25</b> Reagents for 24 tests
Color of Water	0 to 500 PCU (Platinum Cobalt Units)	1 PCU	±10 PCU ±5% of reading at 25 °C	420 nm	Adaptation of the Standard Methods for the Examination of Water and Wastewater, 18th Edition, Colorimetric Platinum Cobalt Method	–
Copper Low Range	0.000 to 1.500mg/L (as Cu <sup>2+</sup> )	0.001mg/L	±0.010mg/L ±5% of reading at 25 °C	575 nm	Adaptation of the EPA Method	<b>HI95747-01</b> Reagents for 100 tests <b>HI95747-03</b> Reagents for 300 tests
Copper High Range	0.00 to 5.00 mg/L (as Cu <sup>2+</sup> )	0.01 mg/L	±0.02 mg/L ±4% of reading at 25 °C	575 nm	Adaptation of the EPA Method	<b>HI93702-01</b> Reagents for 100 tests <b>HI93702-03</b> Reagents for 300 tests
Cyanuric Acid	0 to 80 mg/L (as CYA)	1 mg/L	±1 mg/L ±15% of reading at 25 °C	525 nm	Adaptation of the Turbidimetric Method	<b>HI93722-01</b> Reagents for 100 tests <b>HI93722-03</b> Reagents for 300 tests
Fluoride Low Range	0.00 to 2.00 mg/L (as F <sup>-</sup> )	0.01 mg/L	±0.03 mg/L ±3% of reading at 25 °C	575 nm	Adaptation of the Standard Methods for the Examination of Water and Wastewater, 18th Edition, SPADNS Method	<b>HI93729-01</b> Reagents for 100 tests <b>HI93729-03</b> Reagents for 300 tests
Fluoride High Range	0.0 to 20.0 mg/L (as F <sup>-</sup> )	0.1 mg/L	±0.5 mg/L ±3% of reading at 25 °C	575 nm	Adaptation of the Standard Methods for the Examination of Water and Wastewater, 18th Edition, SPADNS Method	<b>HI93739-01</b> Reagents for 100 tests <b>HI93739-03</b> Reagents for 300 tests
Hardness, Calcium	0.00 to 2.70 mg/L (as CaCO <sub>3</sub> )	0.01 mg/L	±0.11 mg/L ±5% of reading at 25 °C	525 nm	Adaptation of the Standard Methods for the Examination of Water and Wastewater, 18th Edition, Calmagite Method	<b>HI93720-01</b> Reagents for 100 tests <b>HI93720-03</b> Reagents for 300 tests
Hardness, Magnesium	0.00 to 2.00 mg/L (as CaCO <sub>3</sub> )	0.01 mg/L	±0.11 mg/L ±5% of reading at 25 °C	525 nm	Adaptation of the Standard Methods for the Examination of Water and Wastewater, 18th Edition, EDTA Colorimetric Method	<b>HI93719-01</b> Reagents for 100 tests <b>HI93719-03</b> Reagents for 300 tests

Parameter	Range	Resolution	Accuracy	Wavelength	Method	Reagent Code
Hardness, Total Low Range	0 to 250 mg/L (as CaCO <sub>3</sub> )	1 mg/L	±5 mg/L ±4% of reading at 25 °C	466 nm	Adaptation of the EPA Method 130.1	<b>HI93735-00</b> Reagents for 100 tests (LR, 0 to 250mg/L)
						<b>HI93735-0</b> Reagents for 300 tests (LR - 100 tests, MR - 100 tests, HR - 100 tests)
Hardness, Total Medium Range	200 to 500 mg/L (as CaCO <sub>3</sub> )	1 mg/L	±7 mg/L ±3% of reading at 25 °C	466 nm	Adaptation of the EPA Method 130.1	<b>HI93735-01</b> Reagents for 100 tests (MR, 200 to 500mg/L)
						<b>HI93735-0</b> Reagents for 300tests (LR - 100 tests, MR - 100 tests, HR - 100tests)
Hardness, Total High Range	400 to 750 mg/L (as CaCO <sub>3</sub> )	1 mg/L	±10 mg/L ±2% of reading at 25 °C	466 nm	Adaptation of the EPA Method 130.1	<b>HI93735-02</b> Reagents for 100 tests (HR, 400 to 750mg/L)
						<b>HI93735-0</b> Reagents for 300 tests (LR - 100 tests, MR - 100 tests, HR - 100 tests)
Hydrazine	0 to 400 µg/L (as N <sub>2</sub> H <sub>4</sub> )	1 µg/L	±4% of full scale reading at 25 °C	466 nm	Adaptation of the ASTM Manual of Water and Environmental Technology, Method D1385, p-Dimethylaminobenzaldehyde Method	<b>HI93704-01</b> Reagents for 100 tests <b>HI93704-03</b> Reagents for 300 tests
Iodine	0.0 to 12.5 mg/L (as I <sub>2</sub> )	0.1 mg/L	±0.1 mg/L ±5% of reading at 25 °C	525 nm	Adaptation of the Standard Methods for the Examination of Water and Wastewater, 18th Edition, DPD Method	<b>HI93718-01</b> Reagents for 100 tests <b>HI93718-03</b> Reagents for 300 tests
Iron Low Range	0.000 to 1.600 mg/L (as Fe)	0.001 mg/L	±0.010 mg/L ±8% of reading at 25 °C	575 nm	Adaptation of the TPTZ Method	<b>HI93746-01</b> Reagents for 50 tests
						<b>HI93746-03</b> Reagents for 150 tests
Iron High Range	0.00 to 5.00 mg/L (as Fe)	0.01 mg/L	±0.04 mg/L ±2% of reading at 25 °C	525 nm	Adaptation of Standard Methods for the Examination of Water and Wastewater, 23rd Edition, 3500-Fe B, Phenanthroline Method	<b>HI93721-01</b> Reagents for 100 tests
						<b>HI93721-03</b> Reagents for 300 tests
Iron (II)	0.00 to 6.00 mg/L (as Fe <sup>2+</sup> )	0.01 mg/L	±0.10 mg/L ±2% of reading at 25 °C	525 nm	Adaptation of Standard Methods for the Examination of Water and Wastewater, 23rd Edition, 3500-Fe B, Phenanthroline Method	<b>HI96776-01</b> Reagents for 100 tests <b>HI96776-03</b> Reagents for 300 tests
Iron(II)/(III)	0.00 to 6.00mg/L (as Fe)	0.01mg/L	±0.10 mg/L ±2% of reading at 25°C	525 nm	Adaptation of Standard Methods for the Examination of Water and Wastewater, 23rd Edition, 3500-Fe B, Phenanthroline Method	<b>HI96777-01</b> Reagents for 100tests <b>HI96777-03</b> Reagents for 300tests
Iron (13 mm Vial)	0.00 to 6.00 mg/L (as Fe)	0.01 mg/L	±0.10 mg/L or ±3% of reading at 25°C	525 nm	Adaptation of Standard Methods for the Examination of Water and Wastewater, 23rd Edition, 3500-Fe B, Phenanthroline Method	<b>HI96786-25</b> Reagents for 25 tests
Iron Total (13 mm Vial)	0.00 to 7.00 mg/L (as Fe)	0.01 mg/L	±0.20 mg/L or ± 3% of reading, whichever is greater	525 nm	Adaptation of Standard Methods for the Examination of Water and Wastewater, 23rd Edition, 3500-Fe B, Phenanthroline Method	<b>HI96778-25</b> Reagents for 25 tests
Magnesium	0 to 150 mg/L (as Mg <sup>2+</sup> )	1 mg/L	±5 mg/L ±3% of reading at 25 °C	466 nm	Adaptation of the Calmagite Method	<b>HI937520-01</b> Reagents for 50 tests
						<b>HI937520-03</b> Reagents for 150 tests
Manganese Low Range	0 to 300 µg/L (as Mn)	1 µg/L	±10 µg/L ±3% of reading at 25 °C	575 nm	Adaptation of the PAN Method	<b>HI93748-01</b> Reagents for 50 tests
						<b>HI93748-03</b> Reagents for 150 tests
Manganese High Range	0.0 to 20.0 mg/L (as Mn)	0.1 mg/L	±0.2 mg/L ±3% of reading at 25 °C	525 nm	Adaptation of the Standard Methods for the Examination of Water and Wastewater, 18th Edition, Periodate Method	<b>HI93709-01</b> Reagents for 100 tests
						<b>HI93709-03</b> Reagents for 300 tests
Molybdenum	0.0 to 40.0 mg/L (as Mo <sup>6+</sup> )	0.1 mg/L	±0.3 mg/L ±5% of reading at 25 °C	420 nm	Adaptation of the Mercaptoacetic Acid Method	<b>HI93730-01</b> Reagents for 100 tests <b>HI93730-03</b> Reagents for 300 tests
Nickel Low Range	0.000 to 1.000 mg/L (as Ni)	0.001 mg/L	±0.010 mg/L ±7% of reading at 25 °C	575 nm	Adaptation of the PAN Method	<b>HI93740-01</b> Reagents for 50 tests
						<b>HI93740-03</b> Reagents for 150 tests
Nickel High Range	0.00 to 7.00 g/L (as Ni)	0.01 g/L	±0.07 g/L ±4% of reading at 25 °C	575 nm	Adaptation of the Photometric Method	<b>HI93726-01</b> Reagents for 100 tests
						<b>HI93726-03</b> Reagents for 300 tests
Nitrate	0.0 to 30.0 mg/L (as NO <sub>3</sub> <sup>-</sup> -N)	0.1 mg/L	±0.5 mg/L ±10% of reading at 25 °C	525 nm	Adaptation of the Cadmium Reduction Method	<b>HI93728-01</b> Reagents for 100 tests
						<b>HI93728-03</b> Reagents for 300 tests
Nitrate (13 mm Vial)	0.0 to 30.0 mg/L (as NO <sub>3</sub> <sup>-</sup> -N)	0.1 mg/L	±1.0 mg/L or ±3% of reading at 25 °C, whichever is greater	420 nm	Chromotropic Acid Method	<b>HI93766-50</b> Reagents for 50 tests
Nitrite, Marine Ultra Low Range	0 to 200 µg/L (as NO <sub>2</sub> <sup>-</sup> -N)	1 µg/L	±10 µg/L ±4% of reading at 25 °C	466 nm	Adaptation of the EPA Diazotization Method 354.1	<b>HI764-25</b> Reagents for 25 tests
Nitrite Low Range	0 to 600 µg/L (as NO <sub>2</sub> <sup>-</sup> -N)	1 µg/L	±20 µg/L ±4% of reading at 25 °C	466 nm	Adaptation of the EPA Diazotization Method 354.1	<b>HI93707-01</b> Reagents for 100 tests
						<b>HI93707-03</b> Reagents for 300 tests
Nitrite Low Range (13 mm Vial)	0 to 600 µg/L (as NO <sub>2</sub> <sup>-</sup> -N)	1 µg/L	±10 µg/L ± 3% of reading at 25°C, whichever is greater	525 nm	Adaptation of the Standard Method for the Examination of Water and Wastewater, 23rd Edition, 4500B Diazotization Method, Nitrogen Nitrite	<b>HI96783-25</b> Reagents for 25 tests
Nitrite Medium Range (13 mm Vial)	0.00 to 6.00 mg/L (as NO <sub>2</sub> <sup>-</sup> -N)	0.01 mg/L	±0.10 mg/L ± 3% of reading at 25°C	525 nm	Adaptation of the Standard Method for the Examination of Water and Wastewater, 23rd Edition, 4500B Diazotization Method, Nitrogen Nitrite	<b>HI96784-25</b> Reagents for 25 tests
Nitrite High Range	0 to 150 mg/L (as NO <sub>2</sub> <sup>-</sup> )	1 mg/L	±4 mg/L ±4% of reading at 25 °C	575 nm	Adaptation of the Ferrous Sulfate Method	<b>HI93708-01</b> Reagents for 100 tests
						<b>HI93708-03</b> Reagents for 300 tests
Nitrogen, Total Low Range (13 mm Vial)	0.0 to 25.0 mg/L (as N)	0.1 mg/L	±1.0 mg/L or ±5% of reading at 25 °C, whichever is greater	420 nm	Chromotropic Acid Method	<b>HI93767A-50</b> Reagents for up to 49 tests

Parameter	Range	Resolution	Accuracy	Wavelength	Method	Reagent Code
Nitrogen, Total High Range (13 mm Vial)	10 to 150 mg/L (as N)	1 mg/L	±3 mg/L or ±4% of reading at 25 °C, whichever is greater	420 nm	Chromotropic Acid Method	<b>HI93767B-50</b> Reagents for up to 49 tests
Oxygen, Dissolved	0.0 to 10.0 mg/L (as O <sub>2</sub> )	0.1 mg/L	±0.4 mg/L ±3% of reading at 25 °C	420 nm	Adaptation of the Standard Methods for the Examination of Water and Wastewater, 18th Edition, Azide Modified Winkler Method	<b>HI93732-01</b> Reagents for 100 tests <b>HI93732-03</b> Reagents for 300 tests
Oxygen Scavengers (Carbohydrazide)	0.00 to 1.50 mg/L (as Carbohydrazide)	0.01 mg/L	±0.02 mg/L ±3% of reading at 25 °C	575 nm	Adaptation of the Iron Reduction Method	<b>HI96773-01</b> Reagents for 50 tests <b>HI96773-03</b> Reagents for 150 tests
Oxygen Scavengers (Diethylhydroxylamine) (DEHA)	0 to 1000 µg/L (as DEHA)	1 µg/L	±5 µg/L ±5% of reading at 25 °C	575 nm	Adaptation of the Iron Reduction Method	<b>HI96773-01</b> Reagents for 50 tests <b>HI96773-03</b> Reagents for 150 tests
Oxygen Scavengers (Hydroquinone)	0.00 to 2.50 mg/L (as Hydroquinone)	0.01 mg/L	±0.04 mg/L ±3% of reading at 25 °C	575 nm	Adaptation of Iron Reduction Method	<b>HI96773-01</b> Reagents for 50 tests <b>HI96773-03</b> Reagents for 150 tests
Oxygen Scavengers (Iso-ascorbic Acid)	0.00 to 4.50 mg/L (as Iso-Ascorbic Acid)	0.01 mg/L	±0.03 mg/L ±3% of reading at 25 °C	575 nm	Adaptation of the Iron Reduction Method	<b>HI96773-01</b> Reagents for 50 tests <b>HI96773-03</b> Reagents for 150 tests
Ozone	0.00 to 2.00 mg/L (as O <sub>3</sub> )	0.01 mg/L	±0.02 mg/L ±3% of reading at 25 °C	525 nm	Colorimetric DPD Method	<b>HI93757-01</b> Reagents for 100 tests <b>HI93757-03</b> Reagents for 300 tests <b>HI93703-52</b> Reagents for 100 tests (Optional)
pH	6.5 to 8.5 pH	0.1 pH	±0.1 pH at 25 °C	525 nm	Adaptation of the Phenol Red Method	<b>HI93710-01</b> Reagents for 100 pH tests <b>HI93710-03</b> Reagents for 300 pH tests
Phosphate, Marine Ultra Low Range	0 to 200 µg/L (as P)	1 µg/L	±5 µg/L ±5% of reading at 25 °C	610 nm	Adaptation of Standard Methods for the Examination of Water and Wastewater, 20th Edition, Ascorbic Acid Method	<b>HI736-25</b> Reagents for 25 tests
Phosphate Low Range	0.00 to 2.50 mg/L (as PO <sub>4</sub> <sup>3-</sup> )	0.01 mg/L	±0.04 mg/L ±4% of reading at 25 °C	610 nm	Adaptation of the Ascorbic Acid Method	<b>HI93713-01</b> Reagents for 100 tests <b>HI93713-03</b> Reagents for 300 tests
Phosphate High Range	0.0 to 30.0 mg/L (as PO <sub>4</sub> <sup>3-</sup> )	0.1 mg/L	±1.0 mg/L ±4% of reading at 25 °C	525 nm	Adaptation of the Standard Methods for the Examination of Water and Wastewater, 18th Edition, Amino Acid Method	<b>HI93717-01</b> Reagents for 100 tests <b>HI93717-03</b> Reagents for 300 tests
Phosphorus, Acid Hydrolyzable (13 mm Vial)	0.00 to 1.60 mg/L (as P)	0.01 mg/L	±0.05 mg/L or ±5% of reading at 25 °C, whichever is greater	610 nm	Adaptation of the EPA method 365.2 and Standard Methods for the Examination of Water and Wastewater, 20th Edition, 4500-P-E, Ascorbic Acid Method	<b>HI93758B-50</b> Reagents for 50 tests
Phosphorus, Reactive Low Range (13 mm Vial)	0.00 to 1.60 mg/L (as P)	0.01 mg/L	±0.05 mg/L or ±4% of reading at 25 °C, whichever is greater	610 nm	Adaptation of the EPA method 365.2 and Standard Methods for the Examination of Water and Wastewater, 20th Edition, 4500-P-E, Ascorbic Acid Method	<b>HI93758A-50</b> Reagents for 50 tests
Phosphorus, Reactive High Range (13 mm Vial)	0.0 to 32.6 mg/L (as P)	0.1 mg/L	±0.5 mg/L or ±4% of reading at 25 °C, whichever is greater	420 nm	Adaptation of the Standard Methods for the Examination of Water and Wastewater, 20th Edition, 4500-P-C, Vanadomolybdophosphoric Acid Method	<b>HI93763A-50</b> Reagents for up to 49 tests
Phosphorus, Total Low Range (13 mm Vial)	0.00 to 1.15mg/L (as P)	0.01 mg/L	±0.05 mg/L or ±6% of reading at 25 °C, whichever is greater	610 nm	Adaptation of the EPA method 365.2 and Standard Methods for the Examination of Water and Wastewater, 20th Edition, 4500-P-E, Ascorbic Acid Method	<b>HI93758C-50</b> Reagents for 50 tests
Phosphorus, Total High Range (13 mm Vial)	0.0 to 32.6 mg/L (as P)	0.1 mg/L	±0.5 mg/L or ±5% of reading at 25 °C, whichever is greater	420 nm	Adaptation of the Standard Methods for the Examination of Water and Wastewater, 20th Edition, 4500-P-C, Vanadomolybdophosphoric Acid Method	<b>HI93763B-50</b> Reagents for up to 49 tests
Potassium	0.0 to 20.0 mg/L (as K)	0.1 mg/L	±3 mg/L ±7% of reading at 25 °C	466 nm	Adaptation of the Turbidimetric Tetraphenylborate Method	<b>HI93750-01</b> Reagents for 100 tests <b>HI93750-03</b> Reagents for 300 tests
Silica Low Range	0.00 to 2.00 mg/L (as SiO <sub>2</sub> )	0.01 mg/L	±0.03 mg/L ±3% of reading at 25 °C	610 nm	Adaptation of the ASTM Manual of Water and Environmental Technology, D859, Heteropoly Molybdenum Blue Method	<b>HI93705-01</b> Reagents for 100 tests <b>HI93705-03</b> Reagents for 300 tests
Silica High Range	0 to 200 mg/L (as SiO <sub>2</sub> )	1 mg/L	±1 mg/L ±5% of reading at 25 °C	466 nm	Adaptation of the EPA Method 370.1 for Drinking, Surface and Saline Waters, Domestic and Industrial Wastes and Standard Method 4500-SiO <sub>2</sub>	<b>HI96770-01</b> Reagents for 100 tests <b>HI96770-03</b> Reagents for 300 tests
Silver	0.000 to 1.000 mg/L (as Ag)	0.001 mg/L	±0.020 mg/L ±5% of reading at 25 °C	575 nm	Adaptation of the PAN Method	<b>HI93737-01</b> Reagents for 50 tests <b>HI93737-03</b> Reagents for 150 tests
Sulfate	0 to 150 mg/L (as SO <sub>4</sub> <sup>2-</sup> )	1 mg/L	±5 mg/L ±3% of reading at 25 °C	466 nm	Sulfate is precipitated with barium chloride crystals	<b>HI93751-01</b> Reagents for 100 tests <b>HI93751-03</b> Reagents for 300 tests
Surfactants, Anionic	0.00 to 3.50 mg/L (as SDBS)	0.01 mg/L	±0.04 mg/L ±3% of reading at 25 °C	610 nm	Adaptation of the EPA Method 425.1 and Standard Methods for the Examination of Water and Wastewater, 20th Edition, 5540C, Anionic Surfactants as MBAS	<b>HI95769-01</b> Reagents for 40 tests
Surfactants, Anionic (13 mm Vial)	0.00 to 3.50 mg/L (as SDBS)	0.01 mg/L	±0.10 mg/L ±5% of reading at 25 °C	610 nm	Adaptation of the Standard Method for the Examination of Water and Wastewater, 23rd Edition, 5540C, Anionic Surfactants as MBAS	<b>HI96782-25</b> Reagents for 25 tests
Surfactants, Cationic (13 mm Vial)	0.00 to 2.50 mg/L (as CTAB)	0.01 mg/L	±0.15 ppm ±3% of reading at 25°C	420 nm	Bromophenol Blue Method	<b>HI96785-25</b> Reagents for 25 tests
Surfactants, Nonionic (13 mm Vial)	0.00 to 6.00 mg/L (TRITON X-100)	0.01 mg/L	±0.10 mg/L ±5% of reading at 25 °C	610 nm	TBPE Method	<b>HI96780-25</b> Reagents for 24 tests
Zinc	0.00 to 3.00 mg/L (as Zn)	0.01 mg/L	±0.03 mg/L ±3% of reading at 25 °C	575 nm	Adaptation of the Standard Methods for the Examination of Water and Wastewater, 18th Edition, Zincon Method	<b>HI93731-01</b> Reagents for 100 tests <b>HI93731-03</b> Reagents for 300 tests

HI83314

# Multiparameter Photometer with COD for Wastewater

with Digital pH Electrode Input

HI83314 benchtop photometer measures 10 different key wastewater quality parameters using 20 different methods that allow for multiple ranges and variations in chemistry for specific applications. The Chemical Oxygen Demand (COD) parameter is included for industrial and municipal wastewater treatment. The Phosphorous and Nitrogen parameters included are beneficial to municipal wastewater treatment customers that need to monitor their biological and chemical nutrient removal process. This photometer features an innovative optical system that uses LED's, narrow band interference filters, focusing lens and both a silicon photodetector for absorbance measurement and a reference detector to maintain a consistent light source ensures accurate and repeatable photometric readings every time.

To save valuable laboratory benchtop space, the HI83314 doubles as a professional pH meter with its digital pH/temperature electrode input. Now one meter can be used for both photometric and pH measurements.



- **Advanced optical system**
  - Innovative optical design that utilizes a reference detector and focusing lens to eliminate errors from changes in the light source and from imperfections in the glass cuvette.
- **Built-in Reaction Timer for Photometric Measurements**
  - The measurement is taken after the countdown timer expires.
  - Countdown timer ensures that all readings are taken at the appropriate reaction intervals regardless of user for better consistency in measurements
- **Absorbance mode**
  - Hanna's exclusive CAL Check cuvettes for validation of light source and detector
  - Allows for the user to plot concentration versus absorbance for a specific wavelength for use with user supplied chemistry or for teaching principles of photometry
- **Units of Measure**
  - Appropriate unit of measure along with chemical form is displayed along with reading
- **Result Conversion**
  - Automatically convert readings to other chemical forms with the touch of a button
- **Cuvette Cover**
  - Aids in preventing stray light from affecting measurements
- **Digital pH Electrode Input**
  - Measure pH and temperature with a single probe
  - Good Laboratory Practice (GLP) to track calibration information including date, time, buffers used, offset and slope for traceability
  - pH CAL Check alerts user to potential problems during the calibration process
  - Space saving having a pH meter and photometer built into one meter
- **Data Logging**
  - Up to 1000 photometric and pH readings can be stored by simply pressing the dedicated LOG button. Logged readings are just as easily recalled by pressing the RCL button
  - Sample ID and User ID information can be added to a logged reading using alphanumeric keypad
- **Backlit 128 x 64 Pixel Graphic LCD Display**
  - Backlit graphic display allows for easy viewing in low light conditions
  - The 128 x 64 Pixel LCD allows for a simplified user interface with virtual keys and on-screen help to guide the user through use of the meter
- **Connectivity**
  - Logged readings can be quickly and easily transferred to a flash drive using the USB-A host port or to a computer using the micro USB-B port
  - Data is exported as a .CSV file for use with common spreadsheet programs
- **Rechargeable Battery**
  - Li-polymer rechargeable battery lasts for 500 measurements or 50 hours of pH measurement
- **Battery Status Indicator**
  - Indicates the amount of battery life left
- **Error Messages**
  - Photometric error messages
  - pH calibration messages include clean electrode, check buffer and check probe

## Specifications

Measurement Channels		5 x optical channels 1 x digital electrode channel (pH measurement)
Photometer	Range	0.000 to 4.000 Abs
	Resolution	0.001 Abs
	Accuracy	±0.003 Abs @ 1.000 Abs
	Light Source	Light Emitting Diode
	Bandpass Filter Bandwidth	8 nm
	Bandpass Filter Wavelength Accuracy	± 1.0 nm
	Light Detector	Silicon photodiode
	Cuvette Types	Round, 24.6mm & 16mm diameter
Number of Methods		34
Probe	Range	-2.00 to 16.00 pH (± 1000.0 mV)*
	Resolution	0.01 pH (0.1 mV)
	Accuracy	0.01 pH (±0.2 mV) @ 25°C / 77°F
	Temperature Compensation	ATC, -5.0 to 100.0°C (23.0 to 212.0°F)*
	Calibration	two-point, from five available buffers (4.01, 6.86, 7.01, 9.18, 10.01 pH)
	Electrode	Intelligent pH / temperature electrode
Temperature	Range	-20.0 to 120.0°C (-4.0 to 248.0°F)
	Resolution	0.1°C (0.1°F)
	Accuracy	±0.5°C @ 25°C (±0.9°F @ 77°F)
Additional Specifications	Logging	1000 readings (mixed photometer and electrode)
	Display	128 x 64 pixel B/W LCD with backlight
	USB-A (Host) functions	Mass-storage host
	USB-B (Device) functions	Power input, mass-storage device
	Battery Life	> 500 photometer measurements or 50 hours of continuous pH measurement
	Power Supply	5 Vdc USB 2.0 power adapter / type micro-Bconnector 3.7 Vdc Li-polymer rechargeable battery, non-serviceable
	Environment	0 to 50°C (32 to 122°F) 0 to 95% RH, non-serviceable
	Dimensions	206 x 177 x 97mm (8.1 x 7.0 x 3.8")
	Weight	1.0 kg (2.2 lbs.)
Ordering Information	<b>HI83314-01</b> (115V) and <b>HI83314-02</b> (230V) is supplied with sample cuvette (4 pcs.), sample cuvette cap (4 pcs.), cloth for wiping cuvettes, scissors, USB cable, 5 Vdc power adapter, 16mm vial adapter, 16mm diameter vial with cap (5 pcs.), instrument quality certificate, and instruction manual.	
Standards	<b>HI83314-11</b> CAL Check Cuvette Kit for HI83314	

## HI83314 Parameter Specifications

Parameter	Range	Resolution	Accuracy	Wavelength	Method	Reagent Code
Ammonia Low Range	0.00 to 3.00 mg/L (as NH <sub>3</sub> -N)	0.01 mg/L	±0.04 mg/L ±4% of reading at 25 °C	420 nm	Adaptation of the ASTM Manual of Water and Environmental Technology, D1426 Nessler Method	<b>HI93700-01</b> Reagents for 100 tests <b>HI93700-03</b> Reagents for 300 tests
Ammonia Low Range (13 mm Vial)	0.00 to 3.00 mg/L (as NH <sub>3</sub> -N)	0.01 mg/L	± 0.10 mg/L or ± 5% of reading at 25 °C, whichever is greater	420 nm	Adaptation of the ASTM Manual of Water and Environmental Technology, D1426 Nessler Method	<b>HI93764A-25</b> Reagents for 25 tests
Ammonia Medium Range	0.00 to 10.00 mg/L (as NH <sub>3</sub> -N)	0.01 mg/L	± 0.05 mg/L ± 5% of reading at 25 °C, whichever is greater	420 nm	Adaptation of the ASTM Manual of Water and Environmental Technology, D1426, Nessler Method	<b>HI93715-01</b> Reagents for 100 tests <b>HI93715-03</b> Reagents for 300 tests
Ammonia High Range	0.0 to 100.0 mg/L (as NH <sub>3</sub> -N)	0.1 mg/L	±0.5 mg/L ± 5% of reading at 25 °C	420 nm	Adaptation of the ASTM Manual of Water and Environmental Technology, D1426, Nessler Method	<b>HI93733-01</b> Reagents for 100 tests <b>HI93733-03</b> Reagents for 300 tests
Ammonia High Range (13 mm Vial)	0.0 to 100.0 mg/L (as NH <sub>3</sub> -N)	0.1 mg/L	± 1.0 mg/L or ± 5% of reading at 25 °C, whichever is greater	420 nm	Adaptation of the ASTM Manual of Water and Environmental Technology, D1426 Nessler Method	<b>HI93764B-25</b> Reagents for 25 tests

\*Limits will be reduced to actual probe / sensor limits.

Parameter	Range	Resolution	Accuracy	Wavelength	Method	Reagent Code
Chlorine, Free	0.00 to 5.00 mg/L (as Cl <sub>2</sub> )	0.01 mg/L	±0.03 mg/L ±3% of reading at 25 °C	525 nm	Adaptation of the EPA DPD Method 330.5	<b>HI93701-F</b> Reagents for 300 tests (liquid) <b>HI93701-01</b> Reagents for 100 tests (powder) <b>HI93701-03</b> Reagents for 300 tests (powder)
Chlorine, Total	0.00 to 5.00 mg/L (as Cl <sub>2</sub> )	0.01 mg/L	±0.03 mg/L ±3% of reading at 25 °C	525 nm	Adaptation of the EPA DPD Method 330.5	<b>HI93701-T</b> Reagents for 300 tests (liquid) <b>HI93711-01</b> Reagents for 100 total tests (powder) <b>HI93711-03</b> Reagents for 300 total tests (powder)
Chromium (VI)/Total (13 mm Vial)	0 to 1000 µg/L (as Cr)	1 µg/L	±10 µg/L ± 3% of reading	525 nm	Adaptation of the Standard Methods of the Examination of Water and Wastewater, 22nd Edition, 3500-Cr, Diphenylcarbazide Method	<b>HI96781-25</b> Reagents for 25 tests
Chemical Oxygen Demand Low Range (13 mm Vial)	0 to 150 mg/L (as O <sub>2</sub> )	1 mg/L	±5 mg/L or ±4% of reading at 25 °C, whichever is greater	420 nm	Adaptation of the EPA 410.4 Approved Method for the COD Determination on Surface Waters and Wastewaters	<b>HI93754A-25</b> Reagents EPA Low Range for 24 tests <b>HI93754D-25</b> Reagents Hg Free Low Range for 24 tests <b>HI93754F-25</b> Reagents ISO Low Range for 24 tests
Chemical Oxygen Demand Medium Range (13 mm Vial)	0 to 1500 mg/L (as O <sub>2</sub> )	1 mg/L	±15 mg/L or ±4% of reading at 25 °C, whichever is greater	610 nm	Adaptation of the EPA 410.4 Approved Method for the COD Determination on Surface Waters and Wastewaters	<b>HI93754B-25</b> Reagents EPA Medium Range for 24 tests <b>HI93754E-25</b> Reagents Hg Free Medium Range for 24 tests <b>HI93754G-25</b> Reagents ISO Medium Range for 24 tests
Chemical Oxygen Demand High Range EPA (13 mm Vial)	0 to 15000 mg/L (as O <sub>2</sub> )	1 mg/L	±150 mg/L or ±2% of reading at 25 °C, whichever is greater	610 nm	Adaptation of the EPA 410.4 Approved Method for the COD Determination on Surface Waters and Wastewaters	<b>HI93754C-25</b> Reagents for 24 tests
Chemical Oxygen Demand Ultra High Range (13 mm Vial)	0.0 to 60.0 ppt (as O <sub>2</sub> )	0.1 ppt	±0.5 ppt ±3% of reading @ 25°C	610 nm	Adaptation of the EPA 410.4 Approved Method for the COD Determination on Surface Waters and Wastewaters	<b>HI93754J-25</b> Reagents for 24 tests
Iron (13 mm Vial)	0.00 to 6.00 mg/L (as Fe)	0.01 mg/L	±0.10 mg/L or ±3% of reading at 25°C	525 nm	Adaptation of Standard Methods for the Examination of Water and Wastewater, 23rd Edition, 3500-Fe B, Phenanthroline Method	<b>HI96786-25</b> Reagents for 25 tests
Iron Total (13 mm Vial)	0.00 to 7.00 mg/L (as Fe)	0.01 mg/L	±0.20 mg/L or ±3% of reading, whichever is greater	525 nm	Adaptation of Standard Methods for the Examination of Water and Wastewater, 23rd Edition, 3500-Fe B, Phenanthroline Method	<b>HI96778-25</b> Reagents for 25 tests
Nitrate (13 mm Vial)	0.0 to 30.0 mg/L (as NO <sub>3</sub> <sup>-</sup> -N)	0.1 mg/L	±1.0 mg/L or ±3% of reading at 25 °C, whichever is greater	420 nm	Chromotropic Acid Method	<b>HI93766-50</b> Reagents for 50 tests
Nitrite Low Range	0 to 600 µg/L (as NO <sub>2</sub> <sup>-</sup> -N)	1 µg/L	±20 µg/L ±4% of reading at 25 °C	466 nm	Adaptation of the EPA Diazotization Method 354.1	<b>HI93707-01</b> Reagents for 100 tests <b>HI93707-03</b> Reagents for 300 tests
Nitrite Low Range (13 mm Vial)	0 to 600 µg/L (as NO <sub>2</sub> <sup>-</sup> -N)	1 µg/L	±10 µg/L ± 3% of reading at 25°C, whichever is greater	525 nm	Adaptation of the Standard Method for the Examination of Water and Wastewater, 23rd Edition, 4500B Diazotization Method, Nitrogen Nitrite	<b>HI96783-25</b> Reagents for 25 tests
Nitrite Medium Range (13 mm Vial)	0.00 to 6.00 mg/L (as NO <sub>2</sub> <sup>-</sup> -N)	0.01 mg/L	±0.10 mg/L ± 3% of reading at 25°C	525 nm	Adaptation of the Standard Method for the Examination of Water and Wastewater, 23rd Edition, 4500B Diazotization Method, Nitrogen Nitrite	<b>HI96784-25</b> Reagents for 25 tests
Nitrite High Range	0 to 150 mg/L (as NO <sub>2</sub> <sup>-</sup> )	1 mg/L	±4 mg/L ±4% of reading at 25 °C	575 nm	Adaptation of the Ferrous Sulfate Method	<b>HI93708-01</b> Reagents for 100 tests <b>HI93708-03</b> Reagents for 300 tests
Nitrogen, Total Low Range (13 mm Vial)	0.0 to 25.0 mg/L (as N)	0.1 mg/L	±1.0 mg/L or ±5% of reading at 25 °C, whichever is greater	420 nm	Chromotropic Acid Method	<b>HI93767A-50</b> Reagents for up to 49 tests
Nitrogen, Total High Range (13 mm Vial)	10 to 150 mg/L (as N)	1 mg/L	±3 mg/L or ±4% of reading at 25 °C, whichever is greater	420 nm	Chromotropic Acid Method	<b>HI93767B-50</b> Reagents for up to 49 tests

Parameter	Range	Resolution	Accuracy	Wavelength	Method	Reagent Code
Phosphorus, Acid Hydrolyzable (13 mm Vial)	0.00 to 1.60 mg/L (as P)	0.01 mg/L	±0.05 mg/L or ±5% of reading at 25 °C, whichever is greater	610 nm	Adaptation of the EPA method 365.2 and Standard Methods for the Examination of Water and Wastewater, 20th Edition, 4500-P-E, Ascorbic Acid Method	<b>HI93758B-50</b> Reagents for 50 tests
Phosphorus, Reactive Low Range (13 mm Vial)	0.00 to 1.60 mg/L (as P)	0.01 mg/L	±0.05 mg/L or ±4% of reading at 25 °C, whichever is greater	610 nm	Adaptation of the EPA method 365.2 and Standard Methods for the Examination of Water and Wastewater, 20th Edition, 4500-P-E, Ascorbic Acid Method	<b>HI93758A-50</b> Reagents for 50 tests
Phosphorus, Reactive High Range (13 mm Vial)	0.0 to 32.6 mg/L (as P)	0.1 mg/L	±0.5 mg/L or ±4% of reading at 25 °C, whichever is greater	420 nm	Adaptation of the Standard Methods for the Examination of Water and Wastewater, 20th Edition, 4500-P C, Vanadomolybdophosphoric Acid Method	<b>HI93763A-50</b> Reagents for up to 49 tests
Phosphorus, Total Low Range (13 mm Vial)	0.00 to 1.15mg/L (as P)	0.01 mg/L	±0.05 mg/L or ±6% of reading at 25 °C, whichever is greater	610 nm	Adaptation of the EPA method 365.2 and Standard Methods for the Examination of Water and Wastewater, 20th Edition, 4500-P-E, Ascorbic Acid Method	<b>HI93758C-50</b> Reagents for 50 tests
Phosphorus, Total High Range (13 mm Vial)	0.0 to 32.6 mg/L (as P)	0.1 mg/L	±0.5 mg/L or ±5% of reading at 25 °C, whichever is greater	420 nm	Adaptation of the Standard Methods for the Examination of Water and Wastewater, 20th Edition, 4500-P C, Vanadomolybdophosphoric Acid Method	<b>HI93763B-50</b> Reagents for up to 49 tests
Surfactants, Anionic (13 mm Vial)	0.00 to 3.50 mg/L (as SDBS)	0.01 mg/L	±0.10 mg/L ±5% of reading at 25 °C	610 nm	Adaptation of the Standard Method for the Examination of Water and Wastewater, 23rd Edition, 5540C, Anionic Surfactants as MBAS	<b>HI96782-25</b> Reagents for 25 tests
Surfactants, Cationic (13 mm Vial)	0.00 to 2.50 mg/L (as CTAB)	0.01 mg/L	±0.15 ppm ±3% of reading at 25°C	420 nm	Bromophenol Blue Method	<b>HI96785-25</b> Reagents for 25 tests
Surfactants, Nonionic (13 mm Vial)	0.00 to 6.00 mg/L (TRITON X-100)	0.01 mg/L	±0.10 mg/L ±5% of reading at 25 °C	610 nm	TBPE Method	<b>HI96780-25</b> Reagents for 24 tests



HI93754A-25

## Wastewater Testing Reagents for HI83399 and HI83314

Elemental form of phosphorus is never found alone but in multiple forms of phosphate including reactive, acid hydrolyzable, and total. Phosphate can be expressed as phosphate or phosphate-phosphorous

### Total Chromium and Chromium VI

Environmental pollution with various forms of Cr results from its numerous uses in the chemical industry, production of dyes, wood preservation, leather tanning, chrome plating, manufacturing of various alloys, and many other applications and products. Cr(VI) is the most mobile form of chromium in the environment and is classified as a known human carcinogen. Acidic environments with high organic content promote the reduction of Cr(VI) to nontoxic Cr(III). The opposite process of Cr(VI) formation from Cr(III) also occurs, particularly in the presence of common reducing substance.

### Total Iron

The limit values of metals in water are always specified as total metals. The heavy metal in water can be divided into two main groups: reactive heavy metal and heavy metal complexed with organic and inorganic forms. In the latter case the sample preparation is essential before an analysis of the total metal content is carried out.

Hanna reagents are suitable for the digestion of undissolved and complexed Iron by heating in an acid environment in the presence of an oxidizing agent. A comparison of the results obtained before and after the digestion shows whether the digestion is necessary. If the digested sample gives higher measured values, bonded Iron are present in the undigested sample, which are not accessible for analysis before the digestion is carried out.

### Total Nitrogen

Total Nitrogen is the sum of all forms of nitrogen including organic ammonia, nitrate and nitrite. Organic nitrogen includes amino acids found in all living matter. In order to measure organically bound nitrogen the sample has to be digested with acid and heat to convert to nitrate

that reacts with chromotropic acid to produce a color proportional to concentration. Total nitrogen is a common wastewater parameter since nitrogen is a nutrient that affects biological growth.

### Reactive Phosphorous

Reactive Phosphorous is the simplest form and is known as phosphate or orthophosphate. It is considered reactive since it easily reacts or bonds with cations. Orthophosphate is commonly added to water to inhibit corrosion of pipes in the distribution of water.



### Acid Hydrolyzable Phosphorous

Acid Hydrolyzable Phosphorous also known, as condensed phosphate is a complex form of orthophosphate that are bound together. These forms include polyphosphate, pyrophosphate and metaphosphate, which are used boiler and cooling tower water treatment for corrosion inhibition of pipes.

### Total Phosphorous

Total Phosphorous (Total P) is the sum of all phosphorous including inorganic (orthophosphate and acid hydrolyzable) and organic matter such as the phosphorous found in living matter (i.e. ATP/ADP). In order to measure the organic phosphorous the sample needs to be digested with an acid and heat in order to breakdown the organically bound phosphorous to the simplest form, orthophosphate.

It is seen that there are different forms of phosphate measurement and it is important to use the correct chemistry for the appropriate one to be measured. Phosphorus is a common parameter measured in wastewater treatment since it can cause eutrophication leading to algal blooms in water.

Parameter	Range	Resolution	Accuracy (@ 25°C)	LED (▲ nm) with Narrow Band Interference Filter	Method	Reagent Code
Chromium, Total and VI (16 mm vial)	0 - 1000 ug/L (as Cr)	1 µg/L	±10 µg/L ±3% of reading	@ 525 nm	diphenylcarbohydrazide	<b>HI96781-25</b> 25 tests
Iron, Total (16 mm vial)	0.00 to 7.00 mg/L (as Fe)	0.01 mg/L	±0.20 mg/L or ± 3%, whichever is greater	@525 nm	phenanthroline	<b>HI96778-25</b> 25 tests
Nitrogen, Total LR (16 mm vial)	0.0 to 25.0 mg/L (as NO <sub>3</sub> <sup>-</sup> - N)	0.1 mg/L	±1.0 mg/L or ±5% of reading, whichever is greater	@ 420 nm	chromotropic acid	<b>HI93767A-50</b> 49 tests
Nitrogen, Total HR (16 mm vial)	0 to 150 mg/L (as N)	1 mg/L	±3 mg/L or ±4% of reading, whichever is greater	@ 420 nm	chromotropic acid	<b>HI93767B-50</b> 50 tests
Phosphorus Reactive LR (16 mm vial)	0.00 to 1.60 mg/L (as P)	0.01 mg/L	±0.05 mg/L or ±4% of reading, whichever is greater	@ 610 nm	ascorbic acid	<b>HI93758A-50</b> 50 tests
Phosphorus Reactive HR (16 mm vial)	0.0 to 32.6 mg/L (as P)	0.1 mg/L	±0.5 mg/L or ±4% of reading, whichever is greater	@ 420 nm	vanadomolybdophosphoric acid	<b>HI93763A-50</b> 49 tests
Phosphorus Acid Hydrolyzable (16 mm vial)	0 to 1.6 mg/L (ppm) (as P)	0.1 mg/L	±0.05 mg/L or ±5% of reading, whichever is greater	@ 610 nm	ascorbic acid	<b>HI93758B-50</b> 50 tests
Phosphorus, Total LR (16 mm vial)	0.00 to 1.15 mg/L (as P)	0.01 mg/L	±0.05 mg/L or ±6% of reading, whichever is greater	@ 610 nm	ascorbic acid	<b>HI93758C-50</b> 50 tests
Phosphorus, Total HR (16 mm vial)	0.0 to 32.6 mg/L (as P)	0.1 mg/L	±0.5 mg/L or ±5% of reading, whichever is greater	@ 420 nm	vanadomolybdophosphoric acid	<b>HI93763B-50</b> 49 tests



# General Accessories for HI83399 and HI83314



HI731340 200 µL automatic pipette



HI731341 1000 µL automatic pipette



HI731342 2000 µL automatic pipette



HI731350 200 µL automatic pipette tips (25)



HI731351 1000 µL automatic pipette tips (25)

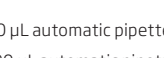

HI731352 2000 µL automatic pipette tips (4)



HI83300-100 sample preparation kit consisting of activated carbon for 50 tests, 100 g demineralizer bottle, 170 mL graduated beaker, 100 mL beaker, 3 mL pipette, 60 mL syringe, 5 mL syringe, graduated cylinder, spoon, funnel, paper filters (25)



HI72083300 carrying case for HI83300 family



HI920015 USB to micro USB cable connector



HI740224 plastic beaker 170 mL (12)



HI76404A electrode holder for HI83300 family



HI731318 cuvette cleaning cloth (4)



HI740225 60 mL graduated syringe



HI740226 5 mL graduated syringe



HI11310 digital combination pH electrode



HI731331 cuvette (4)

HI731335N caps for cuvette (4)



HI93703-55 activated carbon for 50 tests



HI75110/220U Voltage adapter from 115 VAC to USB 5 VDC (USA plug)

HI75110/220E Voltage adapter from 230 VAC to USB 5 VDC (European plug)



HI740036P beaker, plastic 100 mL (10)

HI740034P cap for 100 mL plastic beaker (10)

HI97106

# Chemical Oxygen Demand Portable Photometer

Low, Medium, High, Ultra High Range

The HI97106 is a waterproof portable photometer with an advanced optical system that uses a Light Emitting Diode and a narrow band interference filter for accurate, repeatable readings. The optical system is sealed from outside dust, dirt, and water.

The meter uses an exclusive positive-locking system to ensure that the vials are placed into the holder in the same position every time.

With the CAL Check™ functionality, users are able to validate instrument performance at any time. Hanna Instruments® CAL Check cuvettes are certified against NIST-traceable reference instrument(s).

The built-in tutorial mode guides users step-by-step through the measurement process. The tutorial mode includes all steps required for sample preparation, the required reagents, and quantities.

The instrument is a compact and versatile photometer designed to accurately determine chemical oxygen demand.

Suitable for field or bench measurements, the photometer features:

- Sophisticated optical system
- Waterproof IP67, floating case
- Backlit LCD
  - The 128 x 64 Pixel LCD allows for a simplified user interface.
- Meter validation using certified CAL Check cuvettes
- Tutorial mode guides the user step-by-step
- Includes auto-data logging features to easily record water testing results
- Battery status indicator and auto-shut off
  - The auto-off feature automatically shuts off the meter after 15 minutes of inactivity in order to conserve battery life.
- Compact size
  - Measures 142.5 mm (5.6") x 102.5 mm (4") and only 50.5 mm (2") thick.

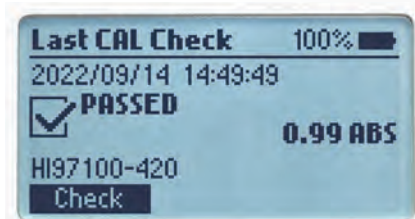

## CAL Check™ validation

Validate instrument performance at any time using CAL Check cuvettes made with NIST traceable standards.

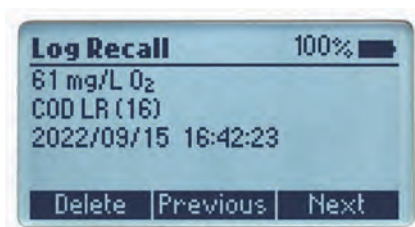

## Auto-data logging

Data autolog helps users keep track of all measurements. Data is automatically saved every time a measurement is made.

The data log can hold 200 individual measurements. When the data log is full, the meter will rewrite the oldest data point.



## On-Screen guides

Step-by-step on-screen guidance.



## Waterproof and floating, IP67 meter design

## Method and Parameter

Chosen parameter and method used is displayed along with the reading.

## Battery status indicator and auto-shut off

The auto-off feature automatically shuts off the meter after 15 minutes of inactivity in order conserve battery life.

## Virtual keys

Menu available at the touch of a button

## Removable vial adapter

The vial adapter can be removed to accommodate HI97106-11 CAL Check™ cuvettes for validation.

## Dedicated help

A dedicated help key provides information relating to the current meter operation, and can be used at any stage in the setup or measurement process to show contextual help.



Specifications	HI97106		
Chemical Oxygen Demand LR	Range	0 to 150 mg/L (as O <sub>2</sub> )	
	Resolution	1 mg/L	
	Accuracy	±5 mg/L or ±4 % of reading at 25 °C, whichever is greater	
	Method	Adaptation of the US EPA 410.4 Approved Method for the COD Determination on Surface Waters and Wastewaters	
	LED	420 nm	
Chemical Oxygen Demand MR	Range	0 to 1500 mg/L (as O <sub>2</sub> )	
	Resolution	1 mg/L	
	Accuracy	±15 mg/L or ±4 % of reading at 25 °C, whichever is greater	
	Method	Adaptation of the US EPA 410.4 Approved Method for the COD Determination on Surface Waters and Wastewaters	
	LED	610 nm	
Chemical Oxygen Demand HR	Range	0 to 15000 mg/L (as O <sub>2</sub> )	
	Resolution	1 mg/L	
	Accuracy	±150 mg/L or ±2 % of reading at 25 °C, whichever is greater	
	Method	Adaptation of the US EPA 410.4 Approved Method for the COD Determination on Surface Waters and Wastewaters	
	LED	610 nm	
Chemical Oxygen Demand UHR	Range	0 to 60.0 g/L (as O <sub>2</sub> )	
	Resolution	0.1 g/L	
	Accuracy	±0.5 g/L ±3 % of reading at 25 °C	
	Method	Adaptation of the US EPA 410.4 Approved Method for the COD Determination on Surface Waters and Wastewaters	
	LED	610 nm	
Measurement system	Light source	LED	
	Bandpass filter	wavelength	420 nm & 610 nm
		bandwidth	8 nm
		wavelength accuracy	±1.0 nm
Light detector	silicon photocell		
Cuvette Type	round, 16 mm diameter		
Photometer Specifications	Auto logging	200 readings	
	Display	128 x 64 pixel B/W LCD with backlight	
	Auto-off	After 15 minutes of inactivity (after 30 minutes of inactivity if a Zero has been done but not a Read)	
	Battery type / Life	1.5 V AA alkaline (3 pcs.) / > 10000 measurements (without backlight)	
	Environment	0 to 50 °C (32 to 122 °F); 0 to 100 % RH, non-serviceable	
	Dimensions	142.5 x 102.5 x 50.5 mm (5.6 x 4.0 x 2.0")	
	Weight	380 g (13.4 oz.); with batteries	
	Casing	IP67 rating, floating	
	Ordering Information	HI97106 is supplied with adapter for 16 mm vial, 1.5V AA Alkaline batteries (3 pcs.), instrument quality certificate, and quick reference guide with instructions for manual download.	
Reagents, Standards, and Accessories	HI97106-11 CAL Check™ standards for HI97106	HI93754E-25 Reagents Hg Free Medium Range for 25 tests	
	HI93754A-25 Reagents EPA Low Range for 25 tests	HI93754F-25 Reagents ISO Low Range for 25 tests	
	HI93754B-25 Reagents EPA Medium Range for 25 tests	HI93754G-25 Reagents ISO Medium Range for 25 tests	
	HI93754C-25 Reagents High Range for 25 tests	HI93754J-25 Reagents Ultra High Range for 25 tests	
	HI93754D-25 Reagents Hg Free Low Range for 25 tests		



HI93754

## COD Certified Standards and Reagents

Each box of 25 vials is supplied with a Hanna certificate of quality. The reagents are traceable to NIST SRM® 930.

- **Compact packaging**
  - Each set of COD vials is stored in fully recyclable, sustainable, compact plastic packaging rather than standard styrofoam. The ergonomic box design reduces the volume of collateral waste and required storage space.
- **Three measurement ranges to satisfy every need**
  - COD levels vary depending on the application and process measuring points. Hanna offers reagents to cover three separate ranges:
    - low range: 0 to 150 mg/L O<sub>2</sub>
    - medium range: 0 to 1500 mg/L O<sub>2</sub>
    - high range: 0 to 15000 mg/L O<sub>2</sub>
- **Accurate and repeatable measurements**
  - Hanna COD reagents have been developed in accordance with Standard Methods 5220D, US EPA 410.4 and ISO 15705:2002 methods.
- **Pre-dosed vials**
  - Hanna vials contain approximately 3 mL of pre-dosed reagent. The operator just needs to add a small quantity of the sample.
- **Safe reagents**
  - Hanna COD reagents are safe for operators and the environment. Vials and caps have been designed to avoid accidental reagent spills. Due to the pre-dosed reagents, the amount of chemicals and handling time is minimized.
- **Quick and accurate measurements**
  - With pre-dosed vials, test preparation time is dramatically reduced. There is no time-consuming reagent preparation procedure or glassware cleaning.



HI93754E-25



New packaging with procedure guide on the inside lid

HI93754C-25

COD Test	Range	Method	Reagent Code
COD LR - 150°C, 2 hours	0 to 150 mg/L (as O <sub>2</sub> )	dichromate EPA*	<b>HI93754A-25</b> (25 tests)
	0 to 150 mg/L	dichromate mercury-free**	<b>HI93754D-25</b> (25 tests)
	0 to 150 mg/L	dichromate ISO***	<b>HI93754F-25</b> (25 tests)
COD MR - 150°C, 2 hours	0 to 1500 mg/L (as O <sub>2</sub> )	dichromate EPA*	<b>HI93754B-25</b> (25 tests)
	0 to 1500 mg/L	dichromate mercury-free**	<b>HI93754E-25</b> (25 tests)
	0 to 1500 mg/L	dichromate ISO***	<b>HI93754G-25</b> (25 tests)
COD HR - 150°C, 2 hours	0 to 15000 mg/L (as O <sub>2</sub> )	dichromate	<b>HI93754C-25</b> (25 tests)
COD UHR - 150°C, 2 hours	0.0 to 60.0 g/L	dichromate	<b>HI93754J-25</b> (25 tests)

**COD Rapid Method: It is now possible to get results for process control monitoring in a fraction of the time using any of the Hanna COD reagents. The Rapid Method digestion time is reduced from 2 hours to 15 minutes when the digestion temperature is increased from 150°C to 170°C.**

COD Test	Range	Rapid Method	Reagent Code
COD LR / Rapid Method - 170°C, 15 minutes	0 to 150 mg/L (as O <sub>2</sub> )	adaptation of dichromate EPA	<b>HI93754A-25</b> (25 tests)
	0 to 1500 mg/L	adaptation of dichromate mercury-free	<b>HI93754D-25</b> (25 tests)
	0 to 1500 mg/L	adaptation of dichromate ISO	<b>HI93754F-25</b> (25 tests)
COD MR / Rapid Method - 170°C, 15 minutes	0 to 150 mg/L (as O <sub>2</sub> )	adaptation of dichromate EPA	<b>HI93754B-25</b> (25 tests)
	0 to 1500 mg/L	adaptation of dichromate mercury-free	<b>HI93754E-25</b> (25 tests)
	0 to 1500 mg/L	adaptation of dichromate ISO	<b>HI93754G-25</b> (25 tests)

## Wastewater Standards

**HI93754-11** 500 ppm COD standard, 500 mL bottle

**HI93754-12** 14000 ppm COD standard, 500 mL bottle

**HI93717-11** phosphate standard 1000 ppm, 500 mL bottle

### Notes:

\* Method with chromium-sulfuric acid is officially recognized by EPA for wastewater analysis.

\*\* This method is recommended for general purpose analysis with no chloride interference.

\*\*\* Method follows the official method ISO 15705. COD MR ISO method is 0-1000 mg/L. Meter can read higher.

HI839800

# COD Test Tube Heater

with 25 Vial Capacity

The HI839800 thermo-reactor is made of sturdy materials and has a vial capacity of up to 25 simultaneous digestions.

- **3 Predefined Temperature Programs**
  - 105 °C for total nitrogen digestion
  - 150 °C for COD and total phosphorous reactions
  - 170 °C for rapid method digestion
- **Built-in Countdown Timer**
  - A timer of up to 180 minutes is included for applications that require timed digestions. When this feature is enabled, a beep is heard and the heating element turns off at the end of the set time period.
- **Status Indicator Lights**
  - POWER (power on)
  - HOT (hot surface warning)
  - HEATING (heating in progress)
- **Overheating Prevention**
  - A thermal fuse in the reactor prevents overheating by turning off the heating element.
- **Reference Temperature Well**
  - A small temperature well can accommodate a temperature probe, useful for verifying the heating block.
- **Two Operating Modes**
  - Idle mode is the default mode in which the instrument displays the heater block current temperature, the target temperature, set reaction time and "Idle" message.
  - Heating mode is activated by the START key. The reactor starts heating to the set temperature. When the temperature is reached and stable, a beep alerts the user that the vials can be inserted into the heater block.
- **Continuous LCD Display**
  - The temperature is continuously displayed on the LCD even when there is no active temperature program running.
- **Error Messages**
  - Displayed messages alert users to problems including high or low temperature, hot surface, or heating system malfunction.



Outer casing stays cool to the touch!

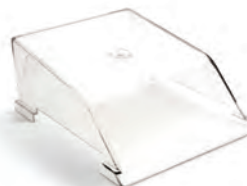

**HI740217**  
Lab Safety Shield



**HI740216**  
Test Tube Cooling Rack

HI740217 safety shield and HI740216 test tube cooling rack should be used when operating the device.

Specifications	HI839800
Temperature Setting	0 °C to 170 °C
Temperature Stability	±0.5 °C
Temperature Range	-10 °C to 170 °C
Preset Programs	P1 (105 °C), P2 (150 °C), P3 (170 °C)
Custom Programs	user-defined settings (C1, C2, C3)
Accuracy	±2 °C (@ 25 °C / 77 °F)
Capacity	25 vials (Ø 16 mm x 100 mm), 1 receptacle for a stainless steel reference thermometer
Warm-up Time	10 to 15 minutes, depending on selected temperature
Operating Mode	Idle or heating
Digestion Mode	Timed (0 to 180 minutes) or continuous On
Environment	5 to 50 °C (41 to 122 °F)
Power Supply (fuse protected)	115 Vac, 60 Hz, 250 W - for HI839800-01 230 Vac, 50 Hz, 250 W - for HI839800-02
Dimensions	190 x 300 x 95 mm (7.5 x 11.8 x 3.7")
Weight	approximately 4.8 kg (10.6 lb.)

### Ordering Information

**HI839800-01** (115V) and **HI839800-02** (230V) is supplied with power cable, instrument quality certificate, quick reference guide with QR code and URL link for manual download.



Introduction.....12.2  
Comparison Guides.....12.5

Turbidity Meters .....12.6  
EPA Meters .....12.6  
ISO Meters.....12.17  
Wine.....12.21  
Beer.....12.22

Solutions and  
Accessories.....12.6

Turbidity of water is an optical property that causes light to be scattered and absorbed, rather than transmitted. The scattering of light that passes through a liquid is primarily caused by suspended solids. The higher the turbidity, the greater the amount of scattered light. Even a very pure fluid will scatter light to a certain degree; no solution will have zero turbidity.

There are different measurement standards used based on applications, and with these standards are applied units. The ISO standard adopted the FNU (Formazin Nephelometric Unit) while the EPA uses the NTU (Nephelometric Turbidity Unit). Other units include the JTU (Jackson Turbidity Unit), FTU (Formazin Turbidity Unit), EBC (European Brewery Convention Turbidity Unit) and diatomaceous earth (mg/L SiO<sub>2</sub>).

	JTU	FTU (NTU/FNU)	SiO <sub>2</sub> (mg/L)
JTU	1	19	2.5
FTU (NTU/FNU)	0.053	1	0.13
SiO <sub>2</sub> (mg/L)	0.4	7.5	1

### Monitoring for Natural Water Supplies

In natural water, turbidity measurements are taken to gauge general water quality and its compatibility in applications where there are aquatic organisms. It has been found that there is a strong correlation between turbidity and BOD (Biochemical Oxygen Demand) value. Moreover, by definition, turbidity obstructs light, thus reducing the growth of marine plants, eggs and larvae, which are usually found in the lower levels of an aquatic ecosystem.



### Wastewater Treatment and Turbidity

Historically, turbidity is one of the main parameters monitored in wastewater. In fact, the monitoring and treatment process was once solely based on the control of turbidity. Currently, the measurement of turbidity at the end of the wastewater treatment process is necessary to verify that the values are within regulatory standards. Generally speaking, the turbidity value has to be between 0 and 50 FTU, with an accuracy of  $\pm 3$  FTU depending on the phase of the wastewater treatment process. By monitoring the turbidity level, it can be determined if the different stages of the process, particularly in the filtration and purification stages, have been completed correctly.

### The Hanna Solution

There are three analytical test methods for turbidity:

- ISO 7027 "Water Quality: Determination of Turbidity"
- USEPA Method No. 180.1, "Turbidity"
- Seawater and Wastewater No. 2130, "Turbidity"

Specific wavelengths are recommended for each method. For the USEPA and Standard Methods, the wavelength in the visible range of the spectrum is recommended, where the European ISO method requires an infrared light source.

### The Infrared Method (ISO 7027)

The ISO 7027 standard specifies the key parameters for the optical system to measure turbidity for drinking and surface water, using the formazin-based metric method. The HI98713 portable turbidimeter meets or exceeds the criteria specified by the ISO 7027 standard.

ISO turbidity meters operate by passing a beam of infrared light through a vial containing the sample to be tested. The light source is a High Emission Infrared LED. A sensor positioned at 90° with respect to the direction of the light detects the amount of light scattered by the undissolved particles present in the sample. A microprocessor converts these readings into FTU (FNU) values.

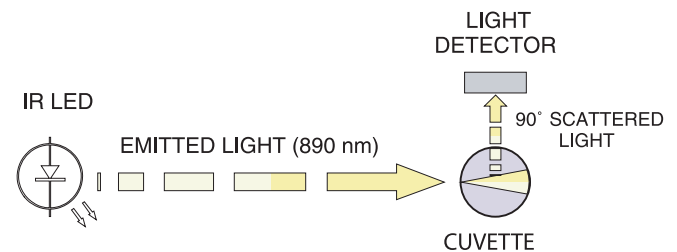

### The US Environmental Protection Agency Approved Method (180.1)

The USEPA Method 180.1 specifies the key parameters for the optical system to measure turbidity for drinking, saline and surface water, in a 0 to 40 NTU range, using the nephelometric method.

Meters compliant with EPA approved methods are designed to meet or exceed the criteria specified by the USEPA Method 180.1 and Standard Method 2130 B.

### Principle of Operation

The light beam that passes through the sample is scattered in all directions. The intensity and pattern of the scattered light is affected by many variables, such as wavelength of the incident light, particle size and shape, refractive index, and color. The optical system includes a tungsten filament lamp or IR LED, a scattered light detector (90°), and a transmitted light detector (180°).



In the ratio turbidimeter range, the microprocessor of the instrument calculates the turbidity value from the signals that reach the two detectors by using an effective algorithm. This algorithm corrects and compensates for interferences of color, making the turbidimeters color-compensated. The optical system and measuring technique also compensate for the lamp or LED intensity fluctuations; minimizing the need for frequent calibration.

In the non-ratio turbidimeter range, the turbidity value is calculated from the signal on the scattered light detector (90°). This method offers a high linearity on the low range but is more sensitive to lamp or LED intensity fluctuations.

The lower detection limit of a turbidimeter is determined by stray light. Stray light is the light detected by the sensors that is not caused by light scattering from suspended particles. The optical systems of turbidimeters are designed to have very low stray light, providing accurate results for low turbidity samples.

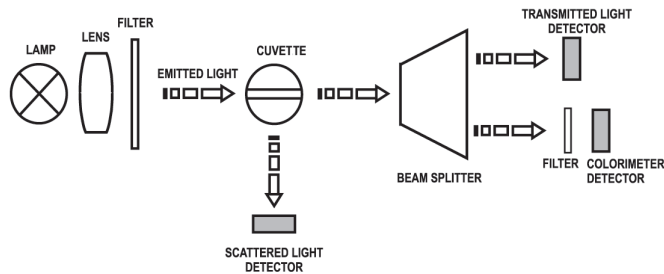

## Standardization

The nephelometric turbidity meter is designed to be routinely standardized with a known light scattering standard. As with all analytical standards or reference materials, a turbidity standard should be able to perform the following: provide traceability, demonstrate the accuracy of results, calibrate the equipment and methodology, monitor user performance, validate tests, and facilitate comparability; this ensures that when the correct procedures have been followed, the same analysis of the same materials will produce results that agree with each other whenever they are performed.

Standards and reference materials should be produced and characterized in a technically competent manner and should be homogenous, stable, certified and have available a known uncertainty of measurement. Presently, there are at least two standards recognized and approved by the USEPA, Standard Methods, ASTM and other regulatory agencies; these are formazin and AMCO AEPA-1.

## Formazin

Formazin is an aqueous suspension of an insoluble polymer formed by the condensation reaction between hydrazine sulphate and hexamethylenetetramine. Although formazin was suggested as a turbidity standard as early as 1926, it has many limitations, such as its high toxicity, low shelf life, quick rate of settling and easy agglomeration. Also, the diluent for formazin standards must be turbidity-free water. This is often difficult to obtain, particularly in a field situation.

## AMCO AEPA-1 Standard

Fortunately, since 1982, there is a standard available which overcomes the shortcomings of formazin. This has been developed by the American company, Advanced Polymer Systems, and is a suspended mixture of styrene divinylbenzene polymer spheres. These standards have the following characteristics:

**Stability:** AMCO AEPA-1 turbidity standards are a stabilized suspension of cross linked styrene divinylbenzene copolymer microbeads in ultrapure water. These beads are chemically inert and keep their chemical balance in a water medium regardless of concentration.

The size scatter of the beads only ranges from 0.06 to 0.2 microns. This small size accounts for random Brownian movement of these beads in suspension, keeping them in constant motion and totally dispersed within the ultra pure water matrix.

**Physical properties:** Particle size, uniform shape and refractive index make these spheres ideal to characterize light absorption and scatter for 90° behavior in the UV-VIS range. In addition, the bead's spherical shape and size impedes the agglomeration or precipitation of the standard. For these reasons, the AMCO AEPA-1 standards are very stable.

**Reliability:** These standards are prepared and bottled in a clean room facility. They are tested for accuracy and stability, fully validated before bottling, and free from any toxic or carcinogenic chemicals or compounds.

Hanna turbidity calibration standards are prepared from NIST traceable primary standard reference materials. All prepared standards are compared to formazin turbidity standard solutions. The values reported on Hanna Certificate of Analysis are the results obtained on the date of analysis. The evaluation of these data is based on Standard Methods.



## Purification of Drinking Water

Turbidity is one of the most important parameters used to determine the quality of drinking water. Public water suppliers are required to treat their water to remove turbidity. In the United States, for systems that use conventional or direct filtration methods, turbidity cannot be higher than 1.0 nephelometric turbidity units (NTU) at the plant outlet, and all samples for turbidity must be less than or equal to 0.3 NTU for at least 95% of the samples in any month. Adequately treated surface water does not usually present a turbidity problem. The World Health

Organization indicates 5 NTU as the reference turbidity value of water for trade. This value has been established based on the aesthetic characteristics of water. From a hygienic point of view, 1 NTU is the recommended value. Many drinking water utilities strive to achieve levels as low as 0.1 NTU.

Turbidity is an indicator and will not give results for a specific pollutant. It will, however, provide information on the degree of overall contamination. The flow chart for the water treatment process of drinking water shows the turbidity reference values for each phase.

Typical sources of turbidity in drinking water include the following:

- Waste discharge
- Run-off from watersheds, especially those that are disturbed or eroding
- Algae or aquatic weeds and products of their breakdown in water reservoirs, rivers, or lakes
- Humic acids and other organic compounds resulting from decay of plants, leaves, etc. in water sources
- High iron concentrations which give water a rust-red coloration (mainly in ground water and ground water under the direct influence of surface water)
- Air bubbles and particles from the treatment process

### Treatment Process of Drinking Water

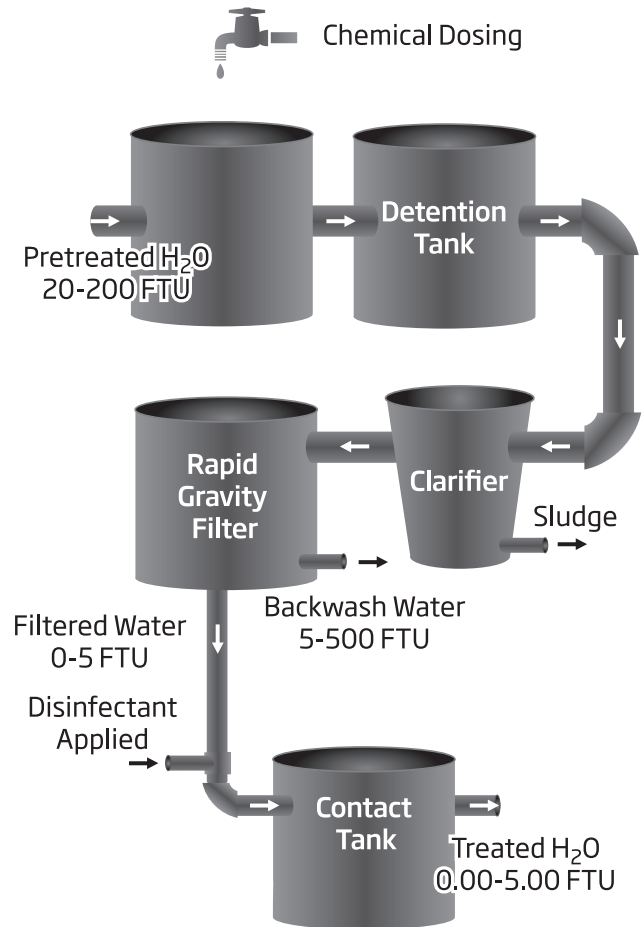



Turbidity	pH	Free Chlorine	Total Chlorine	Bromine (Br)	Iodine (I)	Cyanuric Acid (CYAC)	Iron, LR (Fe, LR)	Ratio Mode	Non-Ratio Mode	FNU Mode	FAU Mode	NTU Ratio Mode	NTU Non-Ratio Mode	Max. Calibration Points	CAL Check™	Logging	EPA Compliant	ISO	GLP	PC Connectivity	Fast Tracker™	Backlit LCD	Auto-off	Page
-----------	----	---------------	----------------	--------------	------------	----------------------	-------------------	------------	----------------	----------	----------	----------------	--------------------	-------------------------	------------	---------	---------------	-----	-----	-----------------	---------------	-------------	----------	------

### EPA Compliant Meters

HI83414	•	•	•					•	•					5	•	•	•			•	•			12.6
HI88703	•							•	•					5		•	•			•	•			12.10
HI93414	•	•	•											4	•	•	•			•	•	•	•	12.12
HI98703	•													4		•	•			•	•	•	•	12.14

### ISO Compliant Meters

HI88713	•									•	•	•	•	5		•		•	•	•		•		12.18
HI98713	•													4		•		•	•	•	•	•	•	12.17
HI93703	•													3				•	•				•	12.20

### Application Specific Meters

HI93102	•	•	•	•	•	•	•							2		•	•						•	12.16
HI83749	•							•						4		•	•		•	•	•	•	•	12.21
HI847492	•													4		•			•	•	•	•	•	12.22

# Turbidity and Free/ Total Chlorine Meter

EPA Compliant

Turbidity

EPA meters



The HI83414 is a multiparameter instrument that measures the most important parameters in drinking water: turbidity and chlorine. The instrument is based on a state-of-the-art optical system which provides accurate results by minimizing stray light and color interferences. Periodic calibration with the supplied standards compensates for any variations in intensity of the tungsten lamp. The colorimeter portion of the meter uses a 525 nm narrow band interference filter for maintaining the proper wavelength in the measurement of free and total chlorine. All measurements are performed with 25 mm round cuvettes composed of special optical glass to ensure maximum repeatability of turbidity and chlorine measurements.

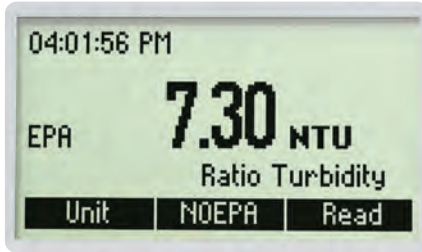

### EPA Compliant

The HI83414 meets and exceeds the requirements of EPA and Standard Methods both for turbidity and colorimetric chlorine measurements. When in EPA mode all turbidity readings are rounded accordingly to meet reporting requirements.



### Backlit Graphic LCD Display

A graphic LCD display provides an easy to understand, user-friendly interface. All messages are in plain text making them easy to read.



### Light blocking cuvette cover

An affixed, light-blocking cuvette cover closes over the sample cell, reducing stray light from affecting any measurement readings.

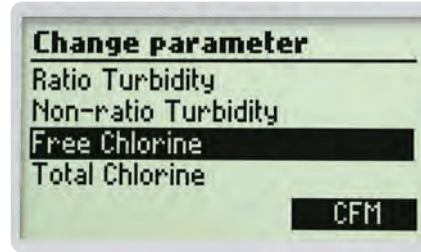

### Four Measurement Modes

The HI83414 features four measurement modes including ratio or non-ratio mode for turbidity, free chlorine, and total chlorine. In ratio mode the turbidity is 0.00 to 4000 NTU (Nephelometric Turbidity Units) while in the non-ratio mode the range is 0.00 to 40.0 NTU. The range for free or total chlorine measurements is 0.00 to 5.00 mg/L (ppm) range.

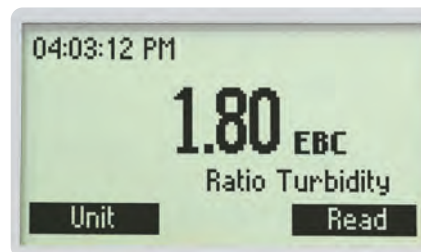

### Multiple Turbidity Units of Measure

Turbidity can be displayed as nephelometric turbidity units (NTU), European Brewing Convention units (EBC) or Nephelos units.

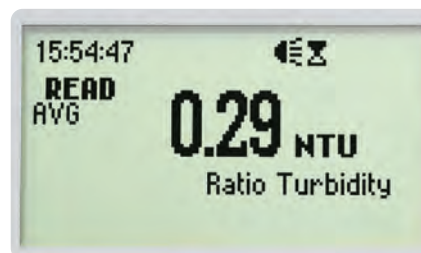

### Multiple reading modes

Normal measurement, continuous measurement, or signal averaging measurement are reading modes available



### CAL Check™

With the powerful CAL Check function, reliable performance of the chlorine colorimeter can be validated at any moment by using the exclusive HANNA ready-made, NIST traceable standards. All standards are supplied with a Certificate of Analysis (COA) for traceability.

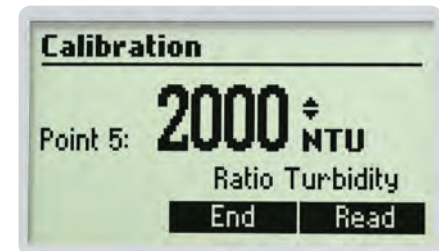

### Calibration

A two, three, four, or five-point turbidity calibration can be performed by using the supplied (<0.1, 15, 100, 750, and 2000 NTU) standards. Calibration points can be modified if user-prepared standards are used. For free and total chlorine, the CAL Check standard can be used for calibration to 1.00 mg/L (ppm).



### AMCO AEPA-1 Primary Turbidity Standard

The AMCO AEPA-1 supplied standards are recognized as a primary standard by the USEPA. These non-toxic standards are made of styrene divinylbenzene polymer spheres that are uniform in size and density. The standards are stable and reusable with a long shelf life. These standards are used for calibration and performance verification of the HI83414 turbidity meter.



- All measurements are performed with 25 mm round cuvettes composed of special optical glass to ensure maximum repeatability of turbidity and chlorine measurements.

### Calibration Error Messages

The calibration is successfully performed if the reading is within certain limits.



If the CAL Check™ standard value is too high, the display will show a high standard message. If this message appears, check if the correct cuvet was used.



If the CAL Check standard value is too low, the display will show low standard message. If this message appears, check if the correct cuvet was used.

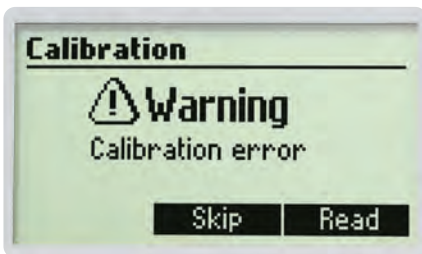

If the calculated calibration coefficients are outside a certain range a calibration error message is displayed.

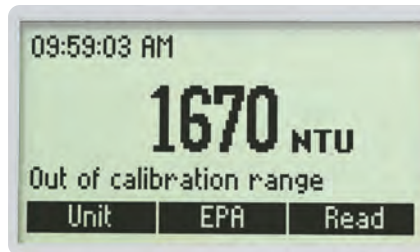

### Out of Cal Range Function

The instrument has a mechanism to prevent taking measurements in a range where the calibration does not assure the best results.

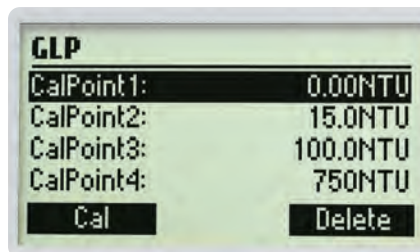

### GLP Data

The HI83414 features complete GLP (Good Laboratory Practice) functions that allow traceability of the calibration conditions. Data includes calibration points, date, and time.

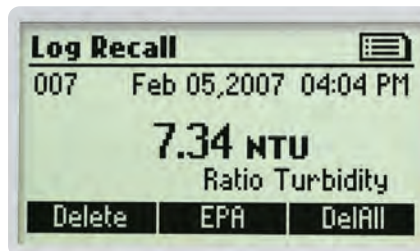

### Data Logging

Up to 200 measurements can be stored in the internal memory and recalled at any time.



### Data Transfer

For further storage or analysis options, logged data can be downloaded to a Windows compatible PC using the USB port and the HI92000 software.

### Tutorial Mode

The unique tutorial mode provides additional information to help the user during measurements. When enabled, the instrument displays explanations and a confirmation button when a preparation or other operation has to be performed.

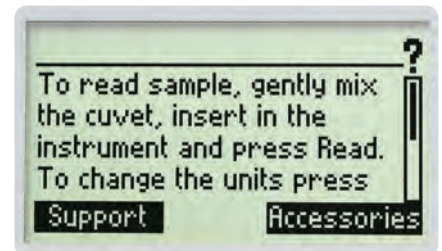

### Contextual Help

Contextual help is always available through a dedicated HELP button. Clear tutorial messages and directions are available on-screen to quickly and easily guide users through setup and calibration. The help information displayed is relative to the setting/option being viewed.

## CAL Check™ standards with certificate

The HI93414-11 free and total chlorine and HI88703-11 turbidity CAL Check standards are used for calibration and performance verification of the HI83414.

- Supplied with Certificate of Analysis
  - Lot number
  - Expiration date
  - Standard value @ 25°C
  - Reference meter NIST traceable
- Provided storage containers
  - Light tight
  - Protects from accidental breakage



### HI83414 Turbidity Specifications

Non-Ratio Mode	Range	0.00 to 9.99; 10.0 to 40.0 NTU 0.0 to 99.9; 100 to 268 Nephelos 0.00 to 9.80 EBC
	Resolution	0.01; 0.1 NTU 0.1; 1 Nephelos 0.01 EBC
Ratio Mode	Range	0.00 to 9.99; 10.0 to 99.9; 100 to 4000 NTU 0.0 to 99.9; 100 to 26800 Nephelos 0.00 to 9.99; 10.0 to 99.9; 100 to 980 EBC
	Resolution	0.01; 0.1; 1 NTU 0.1; 1 Nephelos 0.01; 0.1, 1 EBC
Range Selection	automatic	
Accuracy	±2% of reading plus 0.02 NTU (0.15 Nephelos; 0.01 EBC); ±5% of reading above 1000 NTU (6700 Nephelos; 245 EBC)	
Repeatability	±1% of reading or 0.02 NTU (0.15 Nephelos; 0.01 EBC) whichever is greater	
Stray Light	< 0.02 NTU (0.15 Nephelos; 0.01 EBC)	
Light Detector	silicon photocell	
Method	nephelometric method (90°) or ratio nephelometric method (90° & 180°), adaptation of the USEPA method 180.1 and standard method 2130 B	
Measuring Mode	normal, average, continuous	
Turbidity Standards	<0.1, 15, 100, 750 and 2000 NTU	
Calibration	two, three, four or five-point calibration	

### HI83414 Free and Total Chlorine Specifications

Range	0.00 to 5.00 mg/L (ppm)
Resolution	0.01 mg/L (ppm) from 0.00 to 3.50 mg/L (ppm); 0.10 above 3.50 mg/L (ppm)
Accuracy @25°C/77°F	±0.02 mg/L @ 1.00 mg/L
Detector	silicon photocell with 525 nm narrow band interference filters
Method	adaptation of the USEPA Method 330.5 and Standard Method 4500-Cl G.
Standards	1.00 mg/L (ppm) free chlorine; 1.00 mg/L (ppm) total chlorine
Calibration	one-point calibration

### HI83414 General Specifications

Light Source/ Life	tungsten filament lamp / greater than 100,000 readings
Display	40 x 70 mm graphic LCD (64 x 128 pixels) with backlight
Log Memory	200 records
Connectivity	USB
Environment	0 to 50°C (32 to 122°F); max 95% RH non-condensing
Power Supply	230/115 Vac; 50/60 Hz;
Dimensions	230 x 200 x 145 mm (9.0 x 7.9 x 5.7")
Weight	2.5 kg (88 oz.)
Ordering Information	<b>HI83414-01</b> (115V) and <b>HI83414-02</b> (230V) are supplied with sample cuvettes and caps (5), calibration cuvettes for turbidity (HI88703-11) and colorimeter (HI93414-11), silicone oil (HI98703-58), cuvette wiping cloth, scissors, power cord, instrument quality certificate, and instruction manual.

HI88703

# Precision Turbidity Benchtop Meter

EPA Compliant

The HI88703 Precision Turbidity Benchtop Meter is specially designed for water quality measurements, providing reliable and accurate readings, especially in the low turbidity range. The instrument is based on a state-of-the-art optical system which guarantees accurate results, assures long term stability, and minimizes stray light and color interferences. Periodic calibration with the supplied standards compensates for any variations in intensity of the tungsten lamp. The 25 mm round cuvettes composed of special optical glass guarantee the repeatability of turbidity measurements.

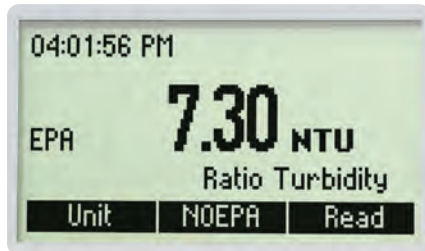

## EPA Compliant

The HI88703 meets and exceeds the requirements of EPA and Standard Methods for turbidity measurements. When in EPA mode all turbidity readings are rounded accordingly to meet reporting requirements.



## Backlit Graphic LCD Display

A graphic LCD display provides an easy to understand, user-friendly interface. All messages are in plain text making them easy to read.

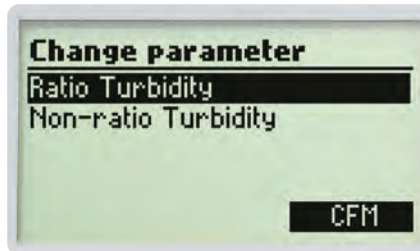

## Two Measurement Modes

The HI88703 features two options for turbidity measurement: ratio and non-ratio mode. Turbidity measurements can be made in the 0.00 to 4000 NTU (Nephelometric Turbidity Units) when using the ratio mode and in the 0.00 to 40.0 NTU range when non-ratio mode is used.

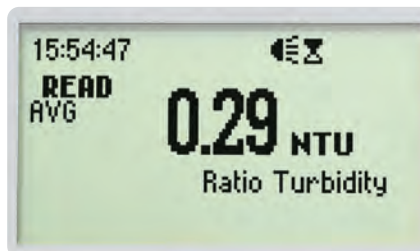

## Multiple reading modes

Normal, continuous, or signal averaging measurement reading modes available.

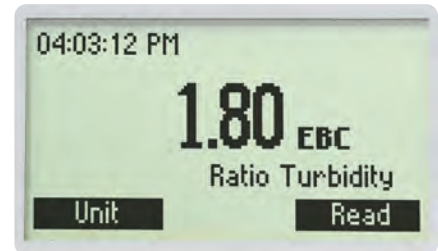

## Multiple Turbidity Units of Measure

Turbidity can be read as Nephelometric Turbidity Units (NTU), European Brewing Convention units (EBC), or Nephelos units.



## Light blocking cuvette cover

An affixed, light-blocking cuvette cover closes over the sample cell, reducing stray light from affecting any measurement readings.



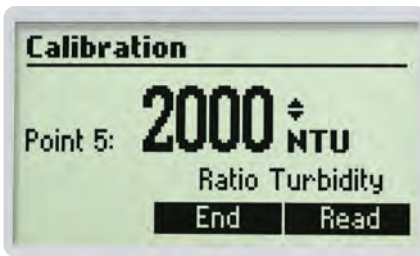

## Calibration

The HI88703 has a powerful calibration function that compensates for lamp aging or changing. A two, three, four, or five-point turbidity calibration can be performed by using the supplied (<0.1, 15, 100, 750, and 2000 NTU) standards. Calibration points can be modified if user-prepared standards are used.

## AMCO AEPA-1 Primary Turbidity Standard

The AMCO AEPA-1 supplied standards are recognized as a primary standard by the USEPA. These non-toxic standards are made of styrene divinylbenzene polymer spheres that are uniform in size and density. The standards are reusable and stable with a long shelf life.

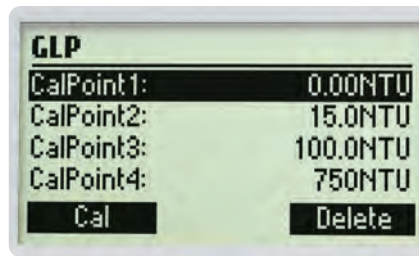

## GLP Data

The HI88703 features complete GLP (Good Laboratory Practice) functions that allow traceability of the calibration conditions. Data includes calibration points, date, and time.

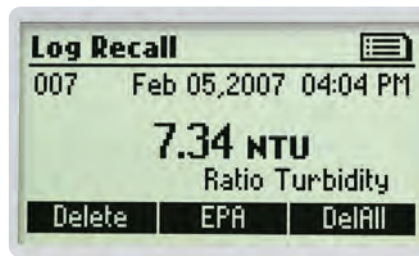

## Data Logging

Up to 200 measurements can be stored in the internal memory and recalled at any time.



## Data Transfer

Logged data can be downloaded to a Windows compatible PC using the USB port and the HI92000 software.

## Tutorial Mode

Tutorial mode provides additional information during measurements. When enabled, the instrument displays explanations and a confirmation button when a preparation or other operation has to be performed.

## Contextual Help

Contextual help is always available through a dedicated HELP button. Clear tutorial messages and directions are available on-screen to guide users through setup and calibration. The help information displayed is relative to the setting/option being viewed.

## Specifications

### HI88703

Non-ratio Mode	Range	0.00 to 9.99; 10.0 to 40.0 NTU 0.0 to 99.9; 100 to 268 Nephelos 0.00 to 9.80 EBC
	Resolution	0.01; 0.1 NTU 0.1; 1 Nephelos 0.01 EBC
Ratio Mode	Range	0.00 to 9.99; 10.0 to 99.9; 100 to 4000 NTU 0.0 to 99.9; 100 to 26800 Nephelos 0.00 to 9.99; 10.0 to 99.9; 100 to 980 EBC
	Resolution	0.01; 0.1; 1 NTU 0.1; 1 Nephelos 0.01; 0.1, 1 EBC
Additional Specifications	Range Selection	automatic
	Accuracy	±2% of reading plus 0.02 NTU (0.15 Nephelos; 0.01 EBC); ±5% of reading above 1000 NTU (6700 Nephelos; 245 EBC)
	Repeatability	±1% of reading or 0.02 NTU (0.15 Nephelos; 0.01 EBC) whichever is greater
	Stray Light	< 0.02 NTU (0.15 Nephelos; 0.01 EBC)
	Light Detector	silicon photocell
	Light Source/ Life	tungsten filament lamp / greater than 100,000 readings
	Display	40 x 70 mm graphic LCD (64 x 128 pixels) with backlight
	Method	nephelometric method (90°) or ratio nephelometric method (90° & 180°), adaptation of the USEPA method 180.1 and standard method 2130 B
	Measuring Mode	normal, average, continuous
	Turbidity Standards	<0.1, 15, 100, 750 and 2000 NTU
	Calibration	two, three, four or five-point calibration
	Log Memory	200 records
	PC Interface	USB
	Environment	0 to 50°C (32 to 122°F); max 95% RH non-condensing
Power Supply	230/115 Vac; 50/60 Hz	
Dimensions	230 x 200 x 145 mm (9 x 7.9 x 5.7")	
Weight	2.5 kg (88 oz.)	
Ordering Information	<b>HI88703-01</b> (115V) and <b>HI88703-02</b> (230V) is supplied with sample cuvettes and caps (5), calibration cuvettes (HI88703-11), silicone oil (HI98703-58), cuvette wiping cloth, power cord, instrument quality certificate, and instruction manual.	

# Turbidity and Free/Total Chlorine Portable Meter

*Fast Tracker™ Technology,  
EPA Compliant*

The HI93414 is a multiparameter instrument that measures the most important parameters in drinking water: turbidity and chlorine. The instrument is based on a state-of-the-art optical system which provides accurate results by minimizing stray light and color interferences. Periodic calibration with the supplied standards compensates for any variations in intensity of the tungsten lamp. The colorimeter portion of the meter uses a 525 nm narrow band interference filter for maintaining the proper wavelength in the measurement of free and total chlorine. All measurements are performed with 25 mm round cuvettes composed of special optical glass to ensure maximum repeatability of turbidity and chlorine measurements.

## EPA Compliant

The HI93414 meets and exceeds the requirements of EPA and Standard Methods both for turbidity and colorimetric chlorine measurements. When the meter is in EPA mode all turbidity readings are rounded accordingly to meet reporting requirements.



## Backlit Display

A backlit LCD display provides an easy to understand, user-friendly interface. Displayed codes guide the user step-by-step through routine operation and calibration.

## Three Measurement Modes

The HI93414 features three options for measurement including ratio mode for turbidity, free chlorine, and total chlorine. Turbidity measurements can be made in the 0.00 to 1000 NTU (Nephelometric Turbidity Units) range, while free or total chlorine measurements can be made in the 0.00 to 5.00 mg/L (ppm) range.



## Multiple reading modes

Normal measurement, continuous measurement, or signal averaging measurement are reading modes available.

## CAL Check™

With the CAL Check function, reliable performance of the chlorine colorimeter can be validated at any moment by using the exclusive HANNA ready-made, NIST traceable standards. All standards are supplied with a Certificate of Analysis (COA) for traceability.

## Calibration

A two, three, or four-point turbidity calibration can be performed by using the supplied (<0.1, 15, 100, and 750 NTU) standards. Calibration points can be modified if user-prepared standards are used. For free and total chlorine, the 1.00 mg/L (ppm) CAL Check standard can be used for calibration and performance verification.

## AMCO AEPA-1 Primary Turbidity Standard

The AMCO AEPA-1 supplied standards are recognized as a primary standard by the USEPA. These non-toxic standards are made of styrene divinylbenzene polymer spheres

that are uniform in size and density. The standards are reusable and stable with a long shelf life.

## GLP Data

The HI93414 features complete GLP (Good Laboratory Practice) functions that allow traceability of the calibration conditions. Data includes calibration points, date, and time.



## Data Logging

Up to 200 measurements can be stored in the internal memory and recalled at any time.

## Data Transfer

For further storage or analysis options, logged data can be downloaded to a Windows compatible PC using the RS232 or USB ports and the HI92000 software.

**FastTracker™**  
location traceability

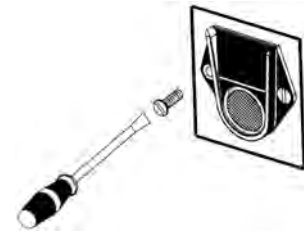

### iButton® Tags are Easy to Install

Install tags near your sampling points for quick and easy iButton® readings. Each tag contains a computer chip with a unique identification code encased in stainless steel. You can install a practically unlimited amount of tags.



HI920005 Tag holders with tags (5)

### Fast Tracker™

For advanced, field applications, the HI93414 is equipped with Fast Tracker™ Tag Identification System (T.I.S.) that makes data collecting and management simpler than ever. Fast Tracker™ allows users to record the time and location of a specific measurement or series of measurements using iButton® tags near sampling points for quick and easy readings. Each iButton® tag contains a computer chip with a unique identification code encased in stainless steel.



Power connector

USB

RS232

Fast Tracker™



#### HI93414 Turbidity

Range	0.00 to 9.99 NTU; 10.0 to 99.9 NTU; 100 to 1000 NTU
Range Selection	automatic
Resolution	0.01; 0.1; 1
Accuracy	±2% of reading plus 0.02 NTU
Repeatability	±1% of reading or 0.02 NTU, whichever is greater
Stray Light	< 0.02 NTU
Light Detector	silicon photocell
Method	ratio nephelometric method (90° and 180°), ratio of scattered and transmitted light; adaptation of the USEPA method 180.1 and standard method 2130 B
Measuring Mode	normal, average, continuous
Turbidity Standards	<0.1, 15, 100 and 750 NTU
Calibration	two, three or four-point calibration

#### HI93414 Free and Total Chlorine

Range	0.00 to 5.00 mg/L
Resolution	0.01 mg/L (0.00 to 3.50 mg/L); 0.10 mg/L (above 3.50 mg/L)
Accuracy @25°C /77°F	±0.02 mg/L @ 1.00 mg/L
Detector	silicon photocell with 525 nm narrow band interference filter
Method	adaptation of the USEPA method 330.5 and standard method 4500-ClG.
Standards	1 mg/L free chlorine, 1 mg/L total chlorine
Calibration	one-point calibration

#### HI93414 General Specifications

Light Source	tungsten filament lamp
Lamp Life	greater than 100,000 readings
Log Memory	200 records
Serial Interface	USB or RS 232
Environment	0 to 50°C (32 to 122°F); RH max 95% non-condensing
Power Supply	1.5V AA alkaline batteries (4) or AC adapter; auto-off after 15 minutes of non-use
Dimensions / Weight	224 x 87 x 77 mm (8.8 x 3.4 x 3.0") / 512 g (18 oz.)

#### Ordering Information

**HI93414-01** (115V) and **HI93414-02** (230V) is supplied with iButton® tags with tag holders (5), sample cuvettes and caps (5), calibration cuvettes for turbidity (HI98703-11), calibration cuvettes for chlorine (HI93414-11), silicone oil (HI98703-5B), cuvette wiping cloth, scissors, batteries, AC adapter, instrument quality certificate, instruction manual and rugged carrying case.

# Turbidity Meter

*Fast Tracker™ Technology,  
EPA Compliant*

The HI98703 Precision Turbidity Portable Meter is specially designed for water quality measurements, providing reliable and accurate readings, especially in the low turbidity range. The instrument is based on a state-of-the-art optical system which guarantees accurate results, assures long term stability, and minimizes stray light and color interferences. Periodic calibration with the supplied standards compensates for any variations in intensity of the tungsten lamp. The 25 mm round cuvettes composed of special optical glass guarantee the repeatability of turbidity measurements.



## EPA Compliant Measurement

The HI98703 meets and exceeds the requirements of EPA and Standard Methods for turbidity measurements. When the meter is in EPA mode all turbidity readings are rounded accordingly to meet reporting requirements.



## Backlit Display

A backlit LCD display provides an easy to understand, user-friendly interface. Displayed codes guide the user step-by-step through routine operation and calibration.

## Multiple reading modes

Normal, continuous, or signal averaging measurement are reading modes available.



## Calibration

A two, three, or four-point turbidity calibration can be performed by using the supplied (<0.1, 15, 100, and 750 NTU) standards. Calibration points can be modified if user-prepared standards are used.

## AMCO AEPA-1 Primary Turbidity Standard

The AMCO AEPA-1 supplied standards are recognized as a primary standard by the USEPA. These non-toxic standards are made of styrene divinylbenzene polymer spheres that are uniform in size and density. The standards are reusable and stable with a long shelf life.

## GLP Data

The HI98703 features complete GLP (Good Laboratory Practice) functions that allow traceability of the calibration conditions. Data includes calibration points, date, and time.



## Data Logging

Up to 200 measurements can be stored in the internal memory and recalled at any time.

## Data Transfer

For further storage or analysis options, logged data can be downloaded to a Windows compatible PC using the RS232 or USB port and the HI92000 software.

**FastTracker™**  
location traceability

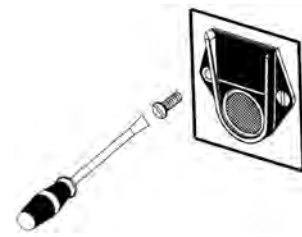

### iButton® Tags are Easy to Install

Install tags near your sampling points for quick and easy iButton® readings. Each tag contains a computer chip with a unique identification code encased in stainless steel. You can install a practically unlimited amount of tags.



HI920005 Tag holders with tags (5)



Specifications	HI98703
Range	0.00 to 9.99 NTU; 10.0 to 99.9 NTU; 100 to 1000 NTU
Range Selection	automatic
Resolution	0.01; 0.1; 1
Accuracy	±2% of reading plus 0.02 NTU
Repeatability	±1% of reading or 0.02 NTU, whichever is greater
Stray Light	< 0.02 NTU
Light Detector	silicon photocell
Light Source	tungsten filament lamp
Lamp Life	greater than 100,000 readings
Method	ratio nephelometric method (90° and 180°), ratio of scattered and transmitted light; adaptation of the USEPA method 180.1 and standard method 2130 B
Measuring mode	normal, average, continuous
Turbidity Standards	<0.1, 15, 100 and 750 NTU
Calibration	two, three or four-point calibration
Log Memory	200 records
Serial Interface	USB or RS232
Environment	0 to 50°C (32 to 122°F); RH max 95% non-condensing
Power Supply	1.5V AA alkaline batteries (4) or AC adapter; auto-off after 15 minutes of non-use
Dimensions / Weight	224 x 87 x 77 mm (8.8 x 3.4 x 3.0") / 512 g (18 oz.)
<b>Ordering Information</b>	<b>HI98703-01</b> (115V) and <b>HI98703-02</b> (230V) are supplied with iButton® tags with tag holders (5), sample cuvettes and caps (5), calibration cuvettes, silicone oil (HI98703-58), cuvette wiping cloth, batteries, AC adapter, instruction manual, instrument quality certificate, and rugged carrying case.

### Fast Tracker™

For advanced field applications, the HI98703 is equipped with Fast Tracker™ Tag Identification System (T.I.S.) that makes data collecting and management simpler than ever. Fast Tracker™ allows users to record the time and location of a specific measurement or series of measurements using iButton® tags near sampling points for quick and easy readings. Each iButton® tag contains a computer chip with a unique identification code encased in stainless steel.



Power connector

USB

RS232

Fast Tracker™

# Meter for Water Analysis

Turbidity, Cl<sub>2</sub>, pH, Br, Fe, I and CYAC

- Custom calibration points
  - Advanced electronics allow operators to calibrate the meter
- Logging
  - Log and recall up to 25 different samples.

The most important parameters needed for water analysis, especially in drinking water, can be measured with Hanna's HI93102 portable meter. This instrument not only measures turbidity, but also pH, total and free chlorine, bromine, iodine, iron, and cyanuric acid (CYAC). Achieve laboratory results in the field quickly and easily.

Measurements are made quickly and repeatedly through a sophisticated, yet easy-to-use microprocessor. In colorimetric mode, users can select between factory pre-programmed calibration or calibrating the meter on their own, and measure either concentration or relative absorbance of the sample. Up to 25 measured samples can be stored in memory, together with time and date. Miniaturization of the electronics has made it possible to offer unsurpassed accuracy and quality in a portable unit weighing just one pound.



## Specifications

	HI93102		
Parameter Specifications	<b>Turbidity</b>	<b>Br-Bromine</b>	
	Range	0.00 to 50.0 NTU†	0.00 to 8.00 mg/L (ppm)
	Resolution	0.01 (0.00 to 9.99) and 0.1 NTU (10.0 to 50.0)	0.01 mg/L (ppm)
	Accuracy @25°C	±0.5 NTU or ±5% of reading (whichever is greater)	±0.08 mg/L (ppm) ±3% of reading
		<b>Free and Total Chlorine</b>	<b>CYAC-Cyanuric Acid</b>
	Range	Free: 0.00 to 2.50 mg/L (ppm); Total: 0.00 to 3.50 mg/L (ppm)	0 to 80 mg/L (ppm)
	Resolution	0.01 mg/L (ppm)	1 mg/L (ppm)
	Accuracy @25°C	±0.03 mg/L (ppm) ±3% of reading	±1 mg/L (ppm) ±15% of reading
		<b>I-Iodine</b>	<b>Fe LR-Iron LR</b>
	Range	0.0 to 12.5 mg/L (ppm)	0.00 to 1.00 mg/L (ppm)
Resolution	0.1 mg/L (ppm)	0.01 mg/L (ppm)	
Accuracy @25°C	±0.1 mg/L (ppm) ±5% of reading	±0.02 mg/L (ppm) ±3% of reading	
	<b>pH</b>		
Range	5.9 to 8.5 pH		
Resolution	0.1 pH		
Accuracy @25°C	±0.1 pH		
Additional Specifications	Turbidity Calibration	two-point; selectable between 0.00 - 50.0 FTU (0.00 and 20.0 FTU recommended)	
	Light Source / Detector	pure green LED / silicon photocell (2)	
	Battery Type / Life	1.5V AA (4) / approximately 60 hours of continuous use or 1000 measurements; automatic shut-off selectable after 10, 20, 30, 40, 50 or 60 minutes of non-use	
	Environment	0 to 50°C (32 to 122°F); RH max 95% (non condensing)	
Dimensions / Weight	220 x 82 x 66 mm (8.7 x 3.2 x 2.6") / 510 g (1.1 lb.)		
Ordering Information	<b>HI93102</b> is supplied with measurement cuvette cap, batteries and instruction manual.		

†1 NTU (Nephelometric Turbidity Unit) = FTU (Formazine Turbidity Unit)  
 \* set of 300 tests available, -03  
 \*\* set of 150 tests available, -03



**FastTracker™**  
location traceability

HI98713 · HI987134

## Turbidity Meter

with Fast Tracker™ Technology, ISO

The HI98713 and HI987134 (Pool Line) Precision ISO Turbidity Portable Meters are specially designed for water quality measurements, providing accurate, reliable readings even within low turbidity ranges.

### Ratio Measurement Mode

These meters measure turbidity using the ratio method with a 90° and 180° light detector for accurate measurements.

### Multiple reading modes

Normal, continuous, or signal averaging measurement reading modes available.

### ISO Compliant

Both meters exceed the requirements of ISO 7027 method for turbidity measurements by use of an infrared LED light source.

### Calibration

HI98713 and HI987134 feature a powerful calibration function that compensates for variation in light intensity. A two, three, or four-point turbidity calibration can be performed by using the supplied (<0.1, 15, 100 and 750 FNU) standards. Calibration points can be modified if user-prepared standards are used.

### AMCO AEPA-1 Primary Turbidity Standard

The AMCO AEPA-1 supplied standards are recognized as a primary standard by the USEPA. These non-toxic standards are made of styrene divinylbenzene polymer spheres that are uniform in size and density. The standards are reusable and stable with a long shelf life.

### GLP Data

Features complete GLP (Good Laboratory Practice) functions that allow traceability of the calibration conditions. Data includes calibration points, date, and time.

### Data Logging

Up to 200 measurements can be stored in the internal memory and recalled at any time.

### Data Transfer

Logged data can be downloaded to a Windows® compatible PC using the USB or RS232 port and the HI92000 software.

### Fast Tracker™

For advanced field applications, the HI98713 is equipped with Fast Tracker™ Tag Identification System (T.I.S.) that makes data collecting and management simpler than ever. Fast Tracker™ allows users to record the time and location of a specific measurement or series of measurements using iButton® tags near sampling points for quick and

easy readings. Each iButton® tag contains a computer chip with a unique identification code encased in stainless steel.

### Backlit Graphic LCD Display

A graphic LCD display provides an easy to understand, user-friendly interface. All messages are in plain text making them easy to read.



Specifications	HI98713	HI987134(Pool Line)
Range	0.00 to 1000 FNU	
Resolution	0.01 (0.00 to 9.99 FNU); 0.1 (10.0 to 99.9 FNU); 1 (100 to 1000 FNU)	
Accuracy	±2% of reading plus 0.1 FNU	
Range Selection	automatic	
Repeatability	±1% of reading or 0.01 FNU, whichever is greater	
Stray Light	< 0.1 FNU	
IR Detector	silicon photocell	
Light Source	860 nm infrared LED	
Lamp Life	greater than 100,000 readings	
Method	adaptation of ISO 7027, ratio method with 90° and 180° detector	
Measuring Mode	normal, average, continuous.	
Turbidity Standards	<0.1, 15, 100 and 750 FNU	
Calibration	two, three or four-point calibration	
Log Memory	200 records	
Serial Interface	USB or RS232	
Environment	0 to 50°C (32 to 122°F); RH max 95% non-condensing	
Power Supply	1.5V AA alkaline batteries (4) or AC adapter; auto-off after 15 minutes of non-use	
Dimensions / Weight	224 x 87 x 77 mm (8.8 x 3.4 x 3.0") / 512 g (18 oz.)	
<b>Ordering Information</b>	<b>HI98713-01</b> (115V), <b>HI98713-02</b> (230V), and <b>HI987134-02</b> (230V) (Pool Line) is supplied with sample cuvettes and caps (5), calibration cuvettes, silicone oil (HI98703-58), cuvette wiping cloth, batteries, AC adapter, instructions and rugged carrying case.	

# Turbidity Benchtop Meter

ISO Compliant



The HI88713 Precision ISO Turbidity Benchtop Meter is specially designed for water quality measurements, providing reliable and accurate readings, even within low turbidity ranges. The instrument is based on a state-of-the-art optical system which guarantees accurate results, assures long term stability, and minimizes stray light and color interferences. Periodic calibration with the supplied standards compensates for any variations in intensity of the tungsten lamp. The 25 mm round cuvettes composed of special optical glass guarantee the repeatability of turbidity measurements.

## ISO Compliant

The HI88713 meets and exceeds the requirements of ISO 7027 method for turbidity measurements by use of an infrared LED light source.

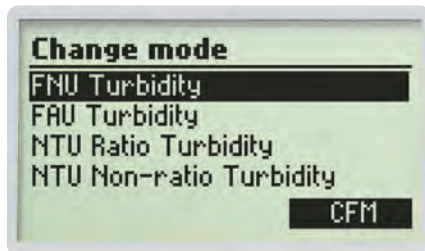

## Four Measurement Modes

The HI88713 features four options for turbidity measurement: FNU (Formazin Nephelometric Units), FAU (Formazin Attenuation Units), and NTU (Nephelometric Turbidity Units) ratio and non-ratio mode. Turbidity ranges for each mode are 0.00 to 1000 FNU, 10.0 to 4000 FAU, 0.00 to 4000 NTU (ratio mode), and 0.00 to 1000 NTU (non-ratio mode).

## Multiple Turbidity Units of Measure

Turbidity can be read as Formazin Nephelometric Units (FNU), Formazin Attenuation Units (FAU), European Brewing Convention units (EBC), and Nephelometric Turbidity Units (NTU).

## Multiple reading modes

Normal, continuous, or signal averaging measurement reading modes available

## AMCO AEPA-1 Primary Turbidity Standard

The AMCO AEPA-1 supplied standards are recognized as a primary standard by the USEPA. These non-toxic standards are made of styrene divinylbenzene polymer spheres that are uniform in size and density. The standards are reusable and stable with a long shelf life.

## Calibration

The HI88713 has a powerful calibration function that compensates for variation in light intensity. A two, three, four, or five-point turbidity calibration can be performed by using the supplied (<0.1, 15, 100, 750 FNU, and 2000 NTU) standards. Calibration points can be modified if user-prepared standards are used.

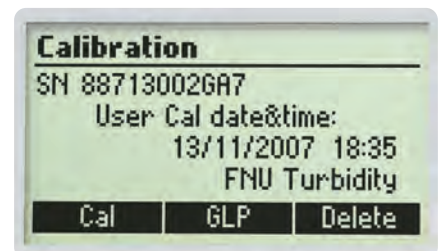

## GLP Data

The HI88713 features complete GLP (Good Laboratory Practice) functions that allow traceability of the calibration conditions. Data includes calibration points, date, and time.



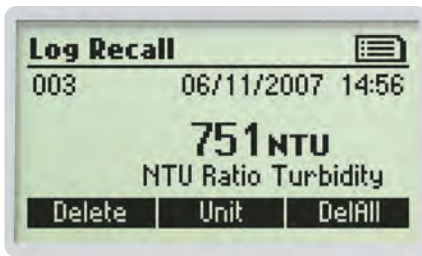

## Data Logging

Up to 200 measurements can be stored in the internal memory and recalled at any time.

## Data Transfer

For further storage or analysis options, logged data can be downloaded to a Windows compatible PC via USB and HI92000 software.

## Tutorial Mode

Tutorial mode provides additional information to help during measurements. When enabled, the instrument displays explanations and a confirmation button when a preparation or other operation has to be performed.

## Contextual Help

Contextual help is always available through a dedicated HELP button. Clear tutorial messages and directions are available on-screen to quickly and easily guide users through setup and calibration. The help information displayed is relative to the setting/option being viewed.



## Backlit Graphic LCD Display

A graphic LCD display provides an easy to understand, user-friendly interface. All messages are in plain text making them easy to read.

Specifications	HI88713	
FNU Mode	Range	0.00 to 1000 FNU
	Resolution	0.01 (0.00 to 9.99 FNU); 0.1 (10.0 to 99.9 FNU); 1 (100 to 1000 FNU)
	Accuracy	±2% of reading plus stray light
FAU Mode	Range	10.0 to 4000 FAU
	Resolution	0.1 (10.0 to 99.9 FAU); 1 (100 to 4000 FAU)
	Accuracy @25°C/77°F	± 10% of reading
NTU Ratio Mode	Range	0.00 to 4000 NTU; 0.00 to 980 EBC
	Resolution	0.01 (0.00 to 9.99 NTU); 0.1 (10.0 to 99.9 NTU); 1 (100 to 4000 NTU) / 0.01 (0.00 to 9.99 EBC); 0.1 (10.0 to 99.9 EBC); 1 (100 to 980 EBC)
	Accuracy	±2% of reading plus stray light; ±5% of reading above 1000 NTU
NTU Non-ratio Mode	Range	0.00 to 1000 NTU; 0.00 to 245 EBC
	Resolution	0.01 (0.00 to 9.99 NTU); 0.1 (10.0 to 99.9 NTU); 1 (100 to 1000 NTU) / 0.01 (0.00 to 9.99 EBC); 0.1 (10.0 to 99.9 EBC); 1 (100 to 245 EBC)
	Accuracy @25°C/77°F	±2% of reading plus stray light
Additional Specifications	Range Selection	automatic
	Repeatability	±1% of reading or stray light, whichever is greater
	Stray Light	< 0.1 NTU (0.05 EBC)
	Light Detector	silicon photocell
	Light Source	IR LED
	Method	ISO 7027 method
	Measuring Mode	normal, average, continuous.
	Turbidity Standards	<0.1, 15, 100, 750 FNU and 2000 NTU
	Calibration	two, three, four or five-point calibration
	Log Memory	200 records
	Serial Interface	USB
	Environment	0°C to 50°C (32 to 122°F); max 95% RH non-condensing
Power Supply	12 Vdc	
Dimensions / Weight	230 x 200 x 145 mm (9 x 7.9 x 5.7") / 2.5 Kg (88 oz.)	
Ordering Information	<b>HI88713-01</b> (115V) and <b>HI88713-02</b> (230V) are supplied with sample cuvettes and caps (6), calibration cuvettes (HI88713-11), silicone oil (HI98703-58), cuvette wiping cloth, power adapter and instruction manual.	

# Turbidity Meter

ISO Compliant

- Positive-locking system ensures cuvette is firmly placed in the cell
- Auto shut-off
- Logging and real time clock (HI93703-11)

The HI93703 turbidity meter is a portable, microprocessor-based instrument used to determine the turbidity of water and wastewater with high precision in the field as well as in the laboratory. The meter is very simple to use and troubleshooting functions can be performed with displayed error code guides.

The HI93703 covers a 0 to 1000 FTU range in two scales: 0.00 to 50.00 FTU and 50 to 1000 FTU. The auto-ranging feature sets the appropriate range for the measurement.

The HI93703-11 adds a real time clock, logging for up to 199 measurements and PC compatibility.

The HI93703 has been designed according to the ISO7027 International Standard, consequently the turbidity unit is the FTU (Formazine Turbidity Unit). FTU is equivalent to the other internationally recognized unit: NTU (Nephelometric Turbidity Unit).

The one-point calibration at 10 FTU\* can be easily performed using the available standard. Hanna has chosen 10 FTU\* as the calibration point because it is the value that best fits the water turbidity measurements in different applications, from drinking water to wastewater treatment.

HANNA instruments uses the primary standard AMCO-AEPA-1 to avoid all formazine-related problems. Formazine is a very toxic, unstable substance, which requires particular care: its standards have to be prepared only a few minutes before performing the calibration, and can-not be reused because of their short life. The HI93703 can be used with both standards.



## Specifications

## HI93703

Range	0.00 to 1000 FTU*
Resolution	0.01 (0.00 to 50.00 FTU); 1 (50 to 1000 FTU)
Accuracy @25°C/77°F	±0.5 FTU or ±5% of reading (whichever is greater)
Calibration	three points (0 FTU, 10 FTU and 500 FTU*)
Light Source / Life	infrared LED / Life of instrument
Light Detector	silicon photocell
Battery Type / Life	1.5V AA (4) /approximately 60 hours of continuous use or 900 measurements; auto-off after 5 minutes of non-use
Environment	0 to 50°C (32 to 122°F); RH max 95% (non condensing)
Dimensions	220 x 82 x 66 mm (8.7 x 3.2 x 2.6")
Weight	510 g (1.1 lb.)
	<b>HI93703-11</b>
Data Logging	199 measurement, on-demand
PC Connection	through RS232 and HI92000 PC software (optional)
Real Time Clock	yes

## Ordering Information

**HI93703** is supplied complete with glass cuvette, batteries and instructions.  
**HI93703C**, includes HI93703 meter, HI731313 maintenance kit (consisting of: cuvettes with caps (2), HI93703-0 AMCO-AEPA-1 0 FTU calibration solution (30 mL), HI93703-10 AMCO-AEPA-1 10 FTU calibration solution (30 mL), HI93703-05 AMCO-AEPA-1 500 FTU calibration solution (30 mL), cuvette wiping cloth, batteries, rugged carrying case and instructions.  
**HI93703-11** is supplied complete with glass cuvette, batteries and instructions in a rugged carrying case.

\*HI93703 has been designed according to the ISO 7027 International Standard, consequently the turbidity unit is the FTU (Formazine Turbidity Unit). FTU is equivalent to the other internationally recognized unit: NTU (Nephelometric Turbidity Unit).

HI83749

# Portable Turbidity Meter

and Bentonite Monitoring

- **GLP Features**
  - Meets Good Laboratory Practices
- **Backlight**
  - Backlit LCD
- **Connectivity**
  - PC interface via USB

Wines with low phenol contents, such as rosé, light reds and whites should be checked for protein stability before bottling. Hanna offers a quick test meter to verify the risk of future protein haze formation. If protein instability is detected, a subsequent test can help define the right amount of bentonite to be added for improving protein stability. It is important not to overdose bentonite to avoid stripping wine flavor, body, and significant loss of color, especially in young red wines. Moreover, adding only the necessary amount of bentonite to obtain the desired protein stability also saves costs.

The HI 83749 measures turbidity of samples from 0.00 to 1200 NTU (Nephelometric Turbidity Units) and is USEPA compliant. In the USEPA measurement mode the instrument rounds the readings to meet USEPA reporting requirements.

## Fast Tracker™

The HI83749 is equipped with Fast Tracker™ Tag Identification System (T.I.S.) that makes data collecting and management simpler than ever. Fast Tracker™ allows users to record the time and location of a specific measurement or series of measurements using iButton® tags near sampling points for quick and easy readings. Each iButton® tag contains a computer chip with a unique identification code encased in stainless steel.



**FastTracker™**  
location traceability

Specifications	HI83749
Range	0.00 to 1200 NTU
Range Selection	automatic
Resolution	0.01 (0.00 to 9.99 NTU); 0.1 (10.0 to 99.9 NTU); 1 (100 to 1200 NTU)
Accuracy @25°C/77°F	±2% of reading plus 0.05 NTU
Repeatability	±1% of reading of 0.02 NTU, whichever is greater.
Stray Light	< 0.05 NTU
Light Source	tungsten filament lamp
Light Detector	silicon photocell
Method	ratio nephelometric method
Display	60 x 90 mm backlit LCD
Calibration	two, three or four points
LOG Memory	200 records
Serial Interface	RS 232 or USB 1.1
Environment	0 to 50°C (32 to 122°F); max 95% RH non-condensing
Battery Type	1.5V AA batteries (4) / 12 VDC adapter
Auto Shut-off	after 15 minutes of non-use
Dimensions	224 x 87 x 77 mm (8.8 x 3.4 x 3.0")
Weight	512 g (18.0 oz.)
<b>Ordering Information</b>	<b>HI83749-01</b> (115V) and <b>HI83749-02</b> (230V) are supplied with iButton® tags with tag holders (5), sample cuvettes and caps (6), calibration cuvettes (4), bentocheck reagent, silicone oil (HI98703-58), 1000 µL automatic pipette with two tips and instructions sheet, 25 mL glass vials with caps (4), 1 mL syringe with two tips, funnel, filter paper (25), cuvette cleaning cloth, 12 VDC adapter, batteries, instructions and rugged carrying case.
<b>Reagents and Standards</b>	<b>HI83749-11</b> Turbidity Calibration Set <b>HI83749-20</b> Bentocheck Solution

\* NTU (Nephelometric Turbidity Units)

See page 12.26 for standards and accessories

HI847492

## Haze Meter

for Beer Quality Analysis

- Can report measurements in FTU, EBC, ASBC and HELM
- PC compatible via USB
- GLP Features
- Log-on-demand
- Large, backlit LCD

The HI847492 is auto-diagnostic meter designed to measure the haze in beer. Each instrument features a different measuring unit or light source to comply with different standard requirements.

HI847492 is designed according to the ASBC (American Society of Brewing Chemists) standard for haze in beer measurements.

This instrument compensates beer color to guarantee accurate readings during the brew process. The optical system consists of an LED and multiple detectors. A two, three or four-point calibration can be easily performed at any time using the supplied or user-prepared standards.

HI847492 has all the necessary GLP (Good Laboratory Practice) features to allow maximum traceability of data. Features include a real time clock, log on demand (up to 200 measurements), and Fast Tracker™ –Tag Identification System.

This meter also incorporates a continuous measurement mode to measure the settling rate of suspended matter, and a signal average (AVG) mode to accumulate multiple readings, giving a final average value. The average mode is particularly useful to measure samples with suspended particles with different dimensions.

This meter also features a user-friendly interface, with a large backlit LCD. Acoustic signals and display codes to guide the user step-by-step through routine operations.

No more judging  
by eye!



**FastTracker™**  
location traceability

The HI847492 is equipped with Fast Tracker™ Tag Identification System (T.I.S.) that makes data collecting and management simpler than ever. Fast Tracker™ allows users to record the time and location of a specific measurement or series of measurements using iButton® tags near sampling points for quick and easy readings. Each iButton® tag contains a computer chip with a unique identification code encased in stainless steel.



## Why this instrument is so important..

Beer haze may be defined as an insoluble or semi-soluble particulate matter which is small enough to form a colloidal suspension in beer. These particles scatter transmitted light and are observed as a degradation in the transparency of the beer.

The beer clarity is a parameter constantly controlled in a brewery, and to assure a consistent product quality, the brewmaster needs more than visual inspection.

Several substances can cause haze in beer, but the most frequently encountered problem is due to a cross-linking of polyphenol and protein.

A range of stabilization treatments are available for avoiding haze problems. The products have to be controlled on several steps during the brewing process, in particular after filtration and before the beer enters the single tanks.

## Methods

Many methods were used to measure turbidity over the years. The Jackson Candle Turbidimeter was used to measure turbidity as Jackson turbidity units (JTU). The method is visual and is not considered very accurate. To obtain more accurate readings, a nephelometer should be used as a turbidity reading instrument.

HI847492 can report the measurements in FTU (Formazin Turbidity Units), EBC (European Brewing Convention), ASBC (American Society of Brewing Chemists) and HELM. FTU units are equal to NTU units (Nephelometric Turbidity Units). A conversion table between these measurement units is shown below.

	NTU/FNU/FTU	EBC	ASBC	HELM
1 NTU/1 FNU/1 FTU	1	0.25	17.25	10
1 EBC	4	1	69	40
1 ASBC	0.058	0.014	1	0.579
1 HELM	0.1	0.025	1.725	1

## Beer Haze Table

Grade	EBC	ASBC
Brilliant	0.0 to 0.5	0.0 to 34.5
Almost Brilliant	0.5 to 1.0	34.5 to 69
Very Slightly Hazy	1.0 to 2.0	69 to 138
Slightly Hazy	2.0 to 4.0	138 to 276
Hazy	4.0 to 8.0	276 to 552
Very Hazy	> 8.0	> 552

## Specifications

### HI847492

Range	0.00 to 9.99; 10.0 to 99.9; 100 to 1000 FTU; 0.00 to 9.99; 10.0 to 99.9; 100 to 250 EBC; 0.00 to 9.99; 10.0 to 99.9; 100 to 17250 ASBC; 0.00 to 9.99; 10.0 to 99.9; 100 to 10000 HELM
Range Selection	automatic
Resolution	0.01, 0.1, 1 FTU, EBC, ASBC, HELM
Accuracy	±2% of reading plus 0.05 FTU (0.01 EBC, 0.86 ASBC, 0.5 HELM)
Repeatability	±1% of reading or 0.02 FTU, 0.01 EBC, 0.035 ASBC, 0.2 HELM; whichever is greater
Stray Light	<0.1 FTU, 0.03 EBC, 1.73 ASBC, 1 HELM
Light Source	LED @ 580 nm
Light Detector	silicon photocell
Method	ratio nephelometric method.
Display	60 x 90 mm backlit LCD
Calibration	two, three or four-point calibration
Log Memory	200 records
Serial Interface	USB
Environment	0 to 50°C (32 to 122°F); RH max 95% non-condensing
Power Supply	1.5V AA alkaline batteries (4) or AC adapter
Auto-off	after 15 minutes of non-use
Dimensions	224 x 87 x 77 mm (8.8 x 3.4 x 3.0")
Weight	512 g (18 oz.)

## Ordering Information

**HI847492-01** (115V) and **HI847492-02** (230V) is supplied with iButton® tags with tag holders (5), sample cuvettes and caps (6), calibration cuvettes (4), silicone oil (HI98703-58), 25 mL glass vials with caps (4), cuvette cleaning cloth, batteries, AC adapter, HI98501 thermometer, instrument quality certificate, instructions and rugged carrying case.

## Accessories

**HI847492-11** Calibration standard cuvette



## HI83414 Standards and Accessories

Reagent Code	Description
HI93414-11	CAL Check™ calibration standards for free and total chlorine
HI93701-01	free chlorine (Cl <sub>2</sub> ) reagent kit, 100 tests
HI93701-03	free chlorine (Cl <sub>2</sub> ) reagent kit, 300 tests
HI93711-01	total chlorine (Cl <sub>2</sub> ) reagent kit, 100 tests
HI93711-03	total chlorine (Cl <sub>2</sub> ) reagent kit, 300 tests
HI88703-11	turbidity calibration standards (<0.1, 15, 100, 750 and 2000 NTU)

Accessory Code	Description
HI93703-50	cuvette cleaning solution, 250 mL
HI98703-58	silicone oil, 15 mL
HI731318	cuvette wiping cloth (4)
HI731331N	glass cuvettes, large (4)
HI731335N	caps for cuvettes, large (4)
HI740234	replacement lamp for EPA turbidimeter
HI92000	Windows® compatible software
HI920013	USB cable for PC connection

See [HI83414](#) on page 12.6

## HI93414 Standards and Accessories

Reagent Code	Description
HI93414-11	CAL Check calibration standards for free and total chlorine
HI93701-01	free Chlorine (Cl <sub>2</sub> ) reagent kit, 100 tests
HI93701-03	free Chlorine (Cl <sub>2</sub> ) reagent kit, 300 tests
HI93711-01	total Chlorine (Cl <sub>2</sub> ) reagent kit, 100 tests
HI93711-03	total Chlorine (Cl <sub>2</sub> ) reagent kit, 300 tests
HI98703-11	turbidity calibration standards (<0.1, 15 100 and 750 NTU)

Accessory Code	Description
HI920005	tag holders with tags (5)
HI93703-50	cuvette cleaning solution, 250 mL
HI98703-58	silicone oil, 15 mL
HI731318	cuvette wiping cloth (4)
HI731331N	glass cuvettes, large (4)
HI731335N	caps for cuvettes, large (4)
HI740234	replacement lamp for EPA turbidimeter
HI92000	Windows® compatible software
HI920013	USB cable for PC connection
HI920011	5 to 9 pin RS232 connection cable

See [HI93414](#) on page 12.12

## HI88703 Standards and Accessories

Reagent Code	Description
HI88703-11	turbidity calibration standards (<0.1, 15, 100, 750 and 2000 NTU)

Accessory Code	Description
HI93703-50	cuvette cleaning solution, 250 mL
HI98703-58	silicone oil, 15 mL
HI731318	cuvette wiping cloth (4)
HI731331N	glass cuvettes, large (4)
HI731335N	caps for cuvettes, large (4)
HI740234	replacement lamp for EPA turbidimeter
HI92000	Windows® compatible software
HI920013	USB cable for PC connection

See [HI88703](#) on page 12.10

## HI98703 Standards and Accessories

Reagent Code	Description
HI98703-11	turbidity calibration standards (<0.1, 15, 100 and 750 NTU)

Accessory Code	Description
HI920005	tag holders with tags (5)
HI93703-50	cuvette cleaning solution, 250 mL
HI98703-58	silicone oil, 15 mL
HI731318	cuvette wiping cloth (4)
HI731331N	glass cuvettes, large (4)
HI731335N	caps for cuvettes, large (4)
HI740234	replacement lamp for EPA turbidimeter
HI92000	Windows® compatible software
HI920013	USB cable for PC connection
HI920011	5 to 9 pin RS232 connection cable

See [HI88703](#) on page 12.14

## HI93102 Solutions and Accessories

Reagent Code	Description
HI93102-0	AMCO-AEPA-1 calibration solution, 0 NTU, 30 mL bottle
HI93102-20	AMCO-AEPA-1 calibration solution, 20 NTU, 30 mL bottle
HI93701-01	free chlorine (Cl <sub>2</sub> ) reagent kit, 100 tests
HI93701-03	free chlorine (Cl <sub>2</sub> ) reagent kit, 300 tests
HI93710-01	pH reagent kit, 100 tests
HI93710-03	pH reagent kit, 300 tests
HI93711-01	total chlorine (Cl <sub>2</sub> ) reagent kit, 100 tests
HI93711-03	total chlorine (Cl <sub>2</sub> ) reagent kit, 300 tests
HI93716-01	bromine (Br) reagent kit, 100 tests
HI93716-03	bromine (Br) reagent kit, 300 tests
HI93718-01	iodine (I) reagent kit, 100 tests
HI93718-03	iodine (I) reagent kit, 300 tests
HI93722-01	cyanuric acid (CYAC) reagent kit, 100 tests
HI93722-03	cyanuric acid (CYAC) reagent kit, 300 tests
HI93746-01	iron (Fe) low range reagent kit, 100 tests
HI93746-03	iron (Fe) low range reagent kit, 300 tests

Accessory Code	Description
HI920005	tag holders with tags (5)
HI93703-50	cuvette cleaning solution, 250 mL
HI731318	cuvette wiping cloth (4)
HI731321	spare glass cuvettes, small (4)

See HI93102 on page 12.16

## HI98713 / HI987134 Standards and Accessories

Reagent Code	Description
HI98713-11*	turbidity calibration standards (<0.1, 15, 100 and 750 FNU)

Accessory Code	Description
HI920005	tag holders with tags (5)
HI93703-50	cuvette cleaning solution, 250 mL
HI98703-58	silicone oil, 15 mL
HI731318	cuvette wiping cloth (4)
HI731331N	glass cuvettes, large (4)
HI731335N	caps for cuvettes, large (4)
HI92000	Windows® compatible software
HI920013	USB cable for PC connection
HI920011	5 to 9 pin RS232 connection cable

\* Vials marked FNU cannot be used in FNU mode – for Ratio NTU calibration only.

See HI98713 / HI987134 on page 12.17

## HI88713 Standards and Accessories

Reagent Code	Description
HI88713-11*	turbidity calibration standards (<0.1, 15, 100, 750 FNU and 2000 NTU)

Accessory Code	Description
HI93703-50	cuvette cleaning solution, 250 mL
HI98703-58	silicone oil, 15 mL
HI731318	cuvette wiping cloth (4)
HI731331N	glass cuvettes, large (4)
HI731335N	caps for cuvettes, large, turbidity (4)
HI92000	Windows® compatible software
HI920013	USB cable for PC connection
HI920011	5 to 9 pin RS232 connection cable

\* Vials marked FNU cannot be used in FNU mode – for Ratio NTU calibration only.

See HI88713 on page 12.18

## HI93703 Standards and Accessories

Reagent Code	Description
HI93703-0	AMCO-AEPA-1 calibration solution, 0 FTU, 30 mL bottle
HI93703-05	AMCO-AEPA-1 calibration solution, 500 FTU, 30 mL bottle
HI93703-10	AMCO-AEPA-1 calibration solution at 10 FTU, 30 mL bottle

Accessory Code	Description
HI731313	maintenance kit: rugged carrying case containing HI93703-0, HI93703-05 and HI93703-10 calibration standards, cuvettes with caps (2) and cuvette wiping cloth
HI93703-50	cuvette cleaning solution, 250 mL
HI98703-58	silicone oil, 15 mL
HI731318	cuvette wiping cloth (4)
HI731321	spare glass cuvettes, small (4)

See HI93703 on page 12.20

## HI83749 Standards and Accessories

Reagent Code	Description
HI83749-11	turbidity calibration kit (<0.10, 10, 100, 500 NTU)
HI83749-20	bentocheck, 100 mL

Accessory Code	Description
HI920005	tag holders with tags (5)
HI740220	25 mL glass vial with cap (2)
HI731341	1000 µL automatic pipette
HI731351	1000µL automatic pipette tips (25)
HI740233	filter paper type II (100)
HI740142P	1 mL graduated syringe (10)
HI740144P	1 mL graduated syringe tips (10)
HI93703-50	cuvette cleaning solution, 250 mL
HI98703-58	silicone oil, 15 mL
HI731318	cuvette wiping cloth (4)
HI731331N	glass cuvettes, large (4)
HI731335N	caps for cuvettes, large (4)
HI740234	replacement lamp for EPA turbidimeter
HI92000	Windows® compatible software
HI920013	USB cable for PC connection

See HI83749 on page 12.21

## HI847492 Standards and Accessories

Reagent Code	Description
HI847492-11	calibration standard cuvette (<0.10, 15, 100 and 800 FTU)

Accessory Code	Description
HI920005	tag holders with tags (5)
HI93703-50	cuvette cleaning solution, 250 mL
HI98703-58	silicone oil, 15 mL
HI731318	cuvette wiping cloth (4)
HI731331N	glass cuvettes, large (4)
HI731335N	caps for cuvettes, large (4)
HI92000	Windows® compatible software
HI920013	USB cable for PC connection

See HI847492 on page 12.22





Introduction.....13.2

Refractometers.....13.3

Sugar in Food ..... 13.3

Wort Sugar Analysis ..... 13.7

Sugar in Wine ..... 13.8

Sodium Chloride in Food ..... 13.10

Natural and Artificial

Seawater ..... 13.12

Ethylene Glycol ..... 13.14

Propylene Glycol ..... 13.14

# Hanna Digital Refractometers

- **Automatic Temperature Compensation**
  - For exceptionally accurate measurements
- **Easy measurement**
  - Place a few drops of the sample in the well and press the READ key
- **BEPS**
  - (Battery Error Prevention System) alerts the user in the event that low battery power could adversely affect readings
- **IP65 water protection**
  - Built to perform under harsh laboratory and field conditions
- **Single-point calibration**
  - Calibrate with distilled or deionized water
- **Small sample size**
  - Sample size can be as small as 2 metric drops
- **Stainless steel sample well**
  - Easy to clean and corrosion-resistant
- **ABS thermoplastic casing**
- **Startup**
  - When powered on, the meter displays battery life and the set measurement units
- **Unit selection**
  - Pressing the RANGE key quickly cycles through the units of measurement (if applicable)



## Refractive Index

Refractive Index is an optical characteristic of a substance and the dissolved particles in it.

The refractive index of a substance is strongly influenced by temperature and the wavelength of light used to measure it. Therefore, care must be taken to control or compensate for temperature differences and wavelength. The refractive index measurements are usually reported at a reference temperature of 20°C (68°F), which is considered to be room temperature.

Refractive index is defined as the ratio of the speed of light in a vacuum to the speed of light in a substance. A result of this property is that light will "bend," or change direction, when it travels through a substance with a different refractive index. This is called refraction.

When passing from a material with a higher to lower refractive index, there is a critical angle

at which an incoming beam of light can no longer refract, but will instead be reflected off the interface between the two substances. This is called total internal reflection.

The critical angle can be used to easily calculate the refractive index according to the equation:

$$\sin(\theta_{\text{critical}}) = n_2 / n_1$$

Where  $n_2$  is the refractive index of the lower-density medium;  $n_1$  is the refractive index of the higher-density medium.

A digital refractometer uses an LED to pass light through a prism in contact with the sample. An image sensor determines the critical angle at which the light is no longer refracted through the sample. Specialized algorithms then apply temperature compensation to the measurement and convert the refractive index to the specified parameter.

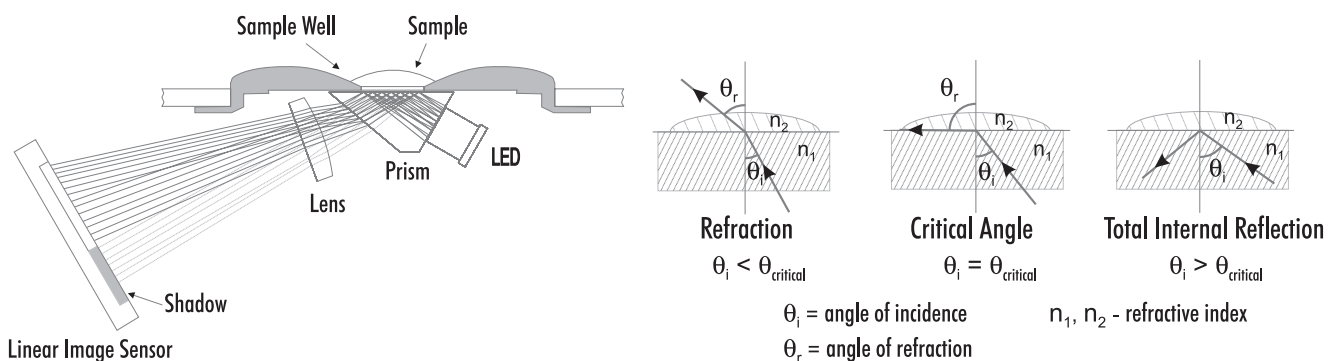

HI96800 · HI96801 · HI96802  
HI96803 · HI96804

## Digital Refractometers

for Sugar Analysis Throughout the Food Industry

- **Ideal for the analysis of:**
  - Fruits, energy drinks, puddings, soy milk, juices, jam, marmalade, honey, soups, jelly, tofu and condiments
- **Dual-level LCD**
  - The dual-level LCD displays measurement and temperature readings simultaneously
- **ATC**
  - Automatic Temperature Compensation
- **Easy measurement**
  - Place a few drops of the sample in the well and press the READ key
- **BEPS**
  - Alerts the user of low battery power that could adversely affect readings
- **IP65 water protection**
  - Built to perform under harsh laboratory and field conditions
- **Quick, accurate results**
  - Readings are displayed in approximately 1.5 seconds
- **One-point calibration**
  - Calibrate with distilled or deionized water
- **Small sample size**
  - Sample size can be as small as 2 metric drops
- **Automatic shut-off**
  - After three minutes of non-use
- **Stainless steel sample well**
  - Easy to clean and corrosion-resistant
- **ABS thermoplastic casing**



### Five Instruments for Sugar Analysis

Hanna offers five sugar refractometers to meet the requirements of the food industry. The HI96800 Refractive Index/Brix, HI96801 % Brix (sucrose), HI96802 Fructose, HI96803 Glucose and HI96804 Invert Sugar digital refractometers are rugged, portable and water-resistant for measurements in the lab or field.

These optical instruments employ the measurement of the refractive index to determine parameters pertinent to sugar concentration analysis.

### Refractive Index

The actual measurement of refractive index is simple, quick and provides the operator a standard accepted method for sugar content analysis. Samples are measured after a simple user calibration with deionized or distilled water. Within seconds these instruments measure the refractive index, apply any necessary calculations and display the results in the selected unit. These digital refractometers eliminate the uncertainty associated with mechanical refractometers and are easily portable for measurements in the field.

### Features

These five instruments utilize internationally recognized references for unit conversion and temperature compensation and employ methodology recommended in the ICUMSA Methods Book (internationally recognized body for sugar analysis).

Temperature (in °C or °F) is displayed simultaneously with the measurement on the large dual-level display along with icons for low power and other helpful messages.

## 5 Digital Refractometers for Sugar Analysis to Choose from



### HI96800

Measures the refractive index in aqueous solutions. Readings can also be displayed with sucrose temperature compensation ( $n_{D_{20}}$ ) or % Brix.

- 1.3300 to 1.5080 Refractive Index range with  $\pm 0.0005$  accuracy
- 0 to 85% Brix range with  $\pm 0.2\%$  accuracy



### HI96801

Measures the refractive index to determine the % Brix of sugar in aqueous solutions. The refractive index of the sample is converted to % Brix concentration units.

- Temperature Compensation algorithms based on sucrose solution
- 0 to 85% Brix range with an accuracy of  $\pm 0.2\%$



### HI96802

Measures the refractive index to determine the % fructose in aqueous solutions. The refractive index of the sample is converted to % mass (% w/w) concentration units.

- Temperature Compensation algorithms based on fructose solution
- 0 to 85% fructose byweight range with an accuracy of  $\pm 0.2\%$



### HI96803

Measures the refractive index to determine the % glucose in aqueous solutions. The refractive index of the sample is converted to % mass (% w/w) concentration units.

- Temperature Compensation algorithms based on glucose solution
- 0 to 85% glucose by weight range with an accuracy of  $\pm 0.2\%$



### HI96804

Measures the refractive index to determine the % invert sugar in aqueous solutions. The refractive index of the sample is converted to % mass (% w/w) concentration units.

- Temperature Compensation algorithms based on invert sugar solution
- 0 to 85% invert sugar by weight range with an accuracy of  $\pm 0.2\%$

# Easy to Operate

## Startup Screens

When the meters are turned on, all of the LCD segments will be displayed followed by the percentage of battery life remaining.

## Calibration

Perform a quick and easy calibration after startup:

1. Using a pipette, completely cover the prism in the sample well with distilled or deionized water.
2. Press the ZERO key.

## Unit Selection

Just press the RANGE key to cycle through the units of measurement (HI96800).

## Measurement

Achieve fast, accurate results:

1. Using a plastic pipette, place sample onto the prism surface until the well is full.
2. Press the READ key and the results are displayed in the selected units.

## Making a Standard % Brix Solution

To make a Brix Solution, follow the procedure below:

- Place container (such as a glass vial or dropper bottle that has a cover) on an analytical balance.
- Tare the balance.
- To make an X % Brix solution, weigh out X grams of high purity sucrose (CAS #: 57-50-1) directly into the container.
- Add distilled or deionized water to the container so the total weight of the solution is 100 g.

Note: Solutions above 60% Brix need to be vigorously stirred or shaken and heated in a water bath. Remove solution from bath when sucrose has dissolved. The total quantity can be scaled proportionally for smaller containers but accuracy may be sacrificed.

### Example with 25% Brix:

% Brix	25
g Sucrose	25.000
g Water	75.000
g Total	100.000

Specifications	HI96800	HI96801	HI96802	HI96803	HI96804	
Sugar Content	Range	1.3300 to 1.5080 nD; 1.3330 to 1.5040 nD <sub>20</sub> ; 0.0 to 85.0% Brix	0 to 85% Brix	0 to 85% mass (% w/w fructose)	0 to 85% mass (% w/w glucose)	0 to 85% mass (% w/w invert sugar)
	Resolution	0.0001 nD; 0.0001 nD <sub>20</sub> ; 0.1 % Brix	0.1 % Brix	0.1 % mass	0.1 % mass	0.1 % mass
	Accuracy (@25°C/77°F)	±0.0005 nD; ±0.0005 nD <sub>20</sub> ; ±0.2% Brix	±0.2% Brix	±0.2% mass	±0.2% mass	±0.2% mass
Temperature	Range	0.0 to 80.0°C (32.0 to 176.0°F)				
	Resolution	0.1°C (0.1°F)				
	Accuracy (@25°C/77°F)	±0.3°C (±0.5°F)				
Additional Specifications	Temperature Compensation	automatic between 10 and 40°C (50 to 104°F)				
	Measurement Time	approximately 1.5 seconds				
	Minimum Sample Volume	100 µL (to cover prism totally)				
	Light Source	yellow LED				
	Sample Cell	stainless steel ring and flint glass prism				
	Auto-off	after three minutes of non-use				
	Enclosure Rating	IP65				
	Battery Type / Battery Life	9V / approximately 5000 readings				
Dimensions / Weight	192 x 102 x 67 mm (7.6 x 4.01 x 2.6") / 420 g (14.8 oz.)					
Ordering Information	HI96800, HI96801, HI96802, HI96803 and HI96804 are supplied with battery and instruction manual.					
Standard	HI4020-11 Brix standard 50%, 10 mL					





## °Plato scale in Brewing

The °Plato scale is a way to quantify the concentration of sugars and dissolved solids in wort. It is used as an indicator of the potential alcoholic strength of a brewing and expresses the fermentability. The HI96841 converts the refractive index reading to °Plato based on the tables maintained by the International Commission for Uniform Methods of Sugar Analysis (ICUMSA) and the American Society of Brewing Chemists (ASBC).



HI96841

## Digital Refractometer

for Measurement of Wort Sugar Analysis

- **Dual-level LCD**
  - Dual-level LCD displays measurement and temperature readings simultaneously
- **ATC**
  - Automatic Temperature Compensation
- **BEPS**
  - Alerts the user of low battery power that could adversely affect readings.
- **IP65 water protection**
  - Built to perform under harsh laboratory and field conditions.
- **Quick, accurate results**
  - Readings are displayed in approximately 1.5 seconds
- **One-point calibration**
  - Calibrate with distilled or deionized water
- **Small sample size**
  - Sample size can be as small as 2 metric drops
- **Automatic shut-off**
  - After three minutes of non-use
- **Stainless steel sample well**
  - Easy to clean and corrosion-resistant
- **Easy measurement**
  - Place a few drops of the sample in the well and press the READ key
- **ABS thermoplastic casing**

### Specifications

### HI96841

Sugar Content	Range	0 to 30 °Plato
	Resolution	0.1 °Plato
	Accuracy (@25°C/77°F)	±0.2 °Plato
Temperature	Range	0 to 80°C (32 to 176°F)
	Resolution	0.1°C (0.1°F)
	Accuracy (@25°C/77°F)	±0.3°C (±0.5°F)
Additional Specifications	Temperature Compensation	automatic between 0 and 40°C (32 to 104°F)
	Measurement Time	approximately 1.5 seconds
	Minimum Sample Volume	100 µL (to cover prism totally)
	Light Source	yellow LED
	Sample Cell	stainless steel ring and flint glass prism
	Auto-off	after three minutes of non-use
	Enclosure Rating	IP65
	Battery Type / Battery Life	9V / approximately 5000 readings
	Dimensions / Weight	192 x 102 x 67 mm (7.6 x 4.01 x 2.6") / 420 g (14.8 oz.)
<b>Ordering Information</b>	<b>HI96841</b> is supplied with battery and instruction manual.	

## Digital Refractometer for Brewing

The HI96841 Digital Refractometer combines form and function into one compact unit. Featuring a 1.5 second response time, the HI96841 measures the refractive index of wort and converts it to °Plato with temperature compensation. The improved easy-to-read LCD screen displays temperature units (°C or °F) and measurements simultaneously. The HI96841's IP65 water-resistant casing and sealed sample well are built to perform under harsh conditions, making it suitable for use in any brewery.

HI96811 · HI96812 · HI96813  
HI96814 · HI96816

## Digital Refractometers

for Measurement of Sugar in Wine

- **Dual-level LCD**
  - Dual-level LCD displays measurement and temperature readings simultaneously
- **ATC**
  - Automatic Temperature Compensation
- **BEPS**
  - Alerts the user of low battery power that could adversely affect readings.
- **IP65 water protection**
  - Built to perform under harsh laboratory and field conditions.
- **Quick, accurate results**
  - Readings are displayed in approximately 1.5 seconds
- **One-point calibration**
  - Calibrate with distilled or deionized water
- **Small sample size**
  - Sample size can be as small as 2 metric drops
- **Automatic shut-off**
  - After three minutes of non-use
- **Stainless steel sample well**
  - Easy to clean and corrosion-resistant
- **Easy measurement**
  - Place a few drops of the sample in the well and press the READ key
- **ABS thermoplastic casing**

### Five Instruments for Wine Analysis

Hanna offers five wine refractometers to meet the various requirements throughout the wine industry. The HI96811, HI96812, HI96813, HI96814 and HI96816 Digital Wine Refractometers are rugged, lightweight and waterproof for measurements in the lab or field.

### Refractive Index

These optical instruments employ the measurement of the refractive index to determine parameters pertinent to the wine industry.

The actual measurement of the refractive index is simple and quick and provides the vintner a standard accepted method for sugar content analysis. Samples are measured



after a simple user calibration with deionized or distilled water. Within seconds, the instrument measures the refractive index of the grape must. These digital refractometers eliminate the uncertainty associated with mechanical refractometers and are ideal for fast, reliable measurements.

### Instrument Descriptions

**HI96811, HI96813 and HI96814** convert the refractive index of the sample to sucrose concentration in units of percent by weight, % Brix (also referred to as °Brix). The conversion used is based on the ICUMSA Methods Book (International Commission for Uniform Methods of Sugar Analysis). Since the majority of sugar in grape juice is fructose and glucose and not sucrose, the reading is sometimes referred to as "Apparent Brix".

**HI96812** has units of °Baumé. The °Baumé scale is based on density and was originally designed to measure the mass of sodium chloride in water. °Baumé is used in winemaking to measure the sugar in must. The HI96812 converts the % Brix reading to °Baumé based on the table found in the Official Methods of Analysis of AOAC International, 18th Edition. One °Baumé is approximately equal to 1.8 % Brix, and 1°Baumé is roughly equivalent to 1% alcohol when the wine is fully fermented.

In addition to % Brix, **HI96814** includes two other scales used in the wine industry: °Oechsle and °KMW.

°Oechsle (°Oe) is mainly used in the German, Swiss and Luxembourgish winemaking industry to measure the sugar content of must. The °Oe scale is based on specific gravity at 20°C (S.G.(20/20)) and is the first 3 digits following the decimal point. One °Oe is roughly equal to 0.2 % Brix.

$$^{\circ}\text{Oe} = [(S.G.(20/20)) - 1] \times 1000$$

°Klosterneuburger Mostwaage (°KMW) is used in Austria to measure the sugar content of must. °KMW is related to °Oe by the following equation:

$$^{\circ}\text{Oe} = ^{\circ}\text{KMW} \times [(0.022 \times ^{\circ}\text{KMW}) + 4.54]$$

1 °KMW is roughly equivalent to 1% Brix or 5 °Oe. °KMW is also known as °Babo.

"Potential" or "probable" alcohol is an estimation of the alcohol content (% vol/vol) in finished wine based on the conversion of sugar to alcohol. This conversion depends on many factors, such as the type of grapes, the grape maturity, the growing region and yeast fermentation efficiency and temperature.



The **HI96813** allows the user to tailor the instrument to their specific needs based on their experience, since no fixed conversion factor is universally applicable. The first conversion is based on the % Brix value and an adjustable conversion factor between 0.50 and 0.70 (0.55 is a common value).

$$\text{Potential alcohol (\% v/v)} = (0.50 \text{ to } 0.70) \times \% \text{ Brix}$$

One drawback of the above equation is that it does not take into account the nonfermentable sugars and extract. A second equation was also added that takes these factors into account and can give a more accurate estimate of the potential alcohol content in the finished wine. This conversion is named "C1" on the meter, and uses the following equation:

$$\text{Potential Alcohol (\%V/V)} = 0.059 \times [(2.66 \times ^\circ\text{Oe}) - 30] (\text{C1})$$

The HI 96816 potential alcohol curve is based on the tables found in the European Economic Community Commission Regulation No 2676/90 of September 17, 1990, Determining Community Methods for the Analysis of Wine and International Organization of Vine and Wine (OIV). The potential alcohol curve is based on the following equation:

$$\text{Potential alcohol (\%v/v)} = \text{g/L of Sugar} / 16.83$$



Specifications	HI96811	HI96812	HI96813	HI96814	HI96816	
Sugar Content	Range	0 to 50% Brix	0 to 28°Baumé	0 to 50% Brix; 0 to 25% V/V Potential Alcohol	0 to 50% Brix; 0 to 230°Oechsle; 0 to 42°KMW	4.9 to 56.8% V/V potential alcohol; (10 to 75% Brix)*
	Resolution	0.1% Brix	0.1°Baumé	0.1% Brix; 0.1% V/V Potential Alcohol	0.1% Brix; 1°Oechsle 0.1°KMW	0.1 %V/V Potential Alcohol
	Accuracy (@25°C/77°F)	±0.2% Brix	±0.1°Baumé	±0.2% Brix; ±0.2 %V/V Potential Alcohol	±0.2% Brix; 1°Oechsle ±0.2°KMW	±0.2 %V/V Potential Alcohol
Temperature	Range	0 to 80°C (32 to 176°F)				
	Resolution	±0.1°C (0.1°F)				
	Accuracy (@25°C/77°F)	±0.3°C (±0.5°F)				
Additional Specifications	Temperature Compensation	automatic between 10 and 40°C (50 to 104°F)				
	Measurement Time	approximately 1.5 seconds				
	Minimum Sample Volume	100 µL (to cover prism totally)				
	Light Source	yellow LED				
	Sample Cell	stainless steel ring and flint glass prism				
	Auto-off	after three minutes of non-use				
	Enclosure Rating	IP65				
	Battery Type / Battery Life	9V / approximately 5000 readings				
Dimensions / Weight	192 x 102 x 67 mm (7.6 x 4.01 x 2.6") / 420 g (14.8 oz.)					
Ordering Information	<b>HI96811, HI96812, HI96813, HI96814</b> and <b>HI96816</b> are supplied with battery and instruction manual.					
Standard	<b>HI4020-11</b> Brix standard 50%, 10 mL					

\* hidden range

HI96821

# Digital Refractometer

for Sodium Chloride Measurement Throughout the Food Industry

- **Ideal for the analysis of:**
  - Salad dressings, cheeses, condiments, pickles, canned foods, jarred foods, milk, juices, energy drinks, soups, brines and whey
- **High accuracy measurements in g/100 g, g/100 mL, specific gravity and °Baume**
- **Dual-level LCD**
  - The dual-level LCD displays measurement and temperature readings simultaneously
- **ATC**
  - Automatic Temperature Compensation
- **Easy measurement**
  - Place a few drops of the sample in the well and press the READ key
- **BEPS**
  - Alerts the user of low battery power that could adversely affect readings.
- **IP65 water protection**
  - Built to perform under harsh laboratory and field conditions
- **Quick, accurate results**
  - Readings are displayed in approximately 1.5 seconds.
- **Single-point calibration**
  - Calibrate with distilled or deionized water
- **Small sample size**
  - Sample size can be as small as 2 metric drops
- **Automatic shut-off**
  - After three minutes of non-use
- **Stainless steel sample well**
  - Easy to clean and corrosion resistant
- **ABS thermoplastic casing**



## Ideal for the Food Industry

Hanna offers the HI96821 digital sodium chloride refractometer to meet the requirements of the food industry. This optical instrument employs the measurement of the refractive index to determine sodium chloride concentration in aqueous solutions used in food preparation. It is not intended for seawater salinity measurements.

## Refractive Index

The measurement of refractive index is simple and quick and provides the user an accepted method for sodium chloride analysis. Samples are measured after a simple user calibration with deionized or distilled water. Within seconds the instrument measures the refractive index of the solution, apply the necessary calculations and display the results in the selected unit. The digital refractometer eliminates the uncertainty associated with mechanical refractometers and is portable for measurements where you need them.

## Features

The instrument utilizes internationally recognized references for unit conversion and temperature compensation. It can display the measurement of NaCl concentration 4 different ways: g/100 g, g/100 mL, Specific Gravity, and °Baumé.

Temperature (in °C or °F) is displayed simultaneously with the measurement on the large dual level display along with icons for Low Power and other helpful message codes.

# Easy to Operate

## Startup Screens

When the HI96821 is turned on, all of the LCD segments will be displayed followed by the percentage of battery life remaining.

## Calibration

Perform a quick and easy calibration after startup:

1. Using a pipette, completely cover the prism in the sample well with distilled or deionized water.
2. Press the ZERO key.

## Unit Selection

Just press the RANGE key to cycle through the HI96821's units of measurement (g/100 g, g/100 mL, Specific Gravity and °Baumé).

## Measurement

Achieve fast, accurate results:

1. Using a plastic pipette, place sample onto the prism surface until the well is full.
2. Press the READ key and the results are displayed in the selected units.

## Making a Standard Sodium Chloride Solution

To make a standard NaCl solution (g/100 g), follow the procedure below:

- Place a container (such as a glass vial or dropper bottle that has a cover) on an analytical balance.
- Tare the balance.
- To make an X NaCl solution weigh out X grams of high purity dried Sodium Chloride (CAS #: 7647-14-5; MW 58.44) directly into the container.
- Add distilled or deionized water to the container so the total weight of the solution is 100 g.

### Example with g/100 g NaCl:

g/100 g NaCl	10
g NaCl	10.000
g Water	90.000
g Total	100.000

Specifications	HI96821	
g/100 g	Range	0 to 28
	Resolution	0.1
	Accuracy (@25°C/77°F)	±0.2
g/100 mL	Range	0 to 34
	Resolution	0.1
	Accuracy (@25°C/77°F)	±0.2
Specific Gravity (S.G.)	Range	1.000 to 1.216
	Resolution	0.001
	Accuracy (@25°C/77°F)	±0.002
°Baumé	Range	0 to 26
	Resolution	0.1
	Accuracy (@25°C/77°F)	±0.2
Temperature	Range	0 to 80°C (32 to 176°F)
	Resolution	0.1°C (0.1°F)
	Accuracy (@25°C/77°F)	±0.3°C (±0.5°F)
Additional Specifications	Temperature Compensation	automatic between 10 and 40°C (50 to 104°F)
	Measurement Time	approximately 1.5 seconds
	Minimum Sample Volume	100 µL (to cover prism totally)
	Light Source	yellow LED
	Sample Cell	stainless steel ring and flint glass prism
	Auto-off	after three minutes of non-use
	Enclosure Rating	IP65
	Battery Type / Battery Life	9V / approximately 5000 readings
Dimensions / Weight	192 x 102 x 67 mm (7.6 x 4.01 x 2.6") / 420 g (14.8 oz.)	
Ordering Information	HI96821 is supplied with battery and instruction manual.	

HI96822

# Digital Refractometer

for Natural or Artificial Seawater Analysis

- Designed for seawater salinity analysis
- High accuracy measurements displayed as PSU, ppt and specific gravity
- Dual-level LCD
  - The dual-level LCD displays measurement and temperature readings simultaneously
- ATC
  - Automatic Temperature Compensation
- Easy measurement
  - Place a few drops of the sample in the well and press the READ key
- BEPS
  - Alerts the user of low battery power that could adversely affect readings
- IP65 water protection
  - Built to perform under the harsh field conditions associated with environments containing seawater.
- Quick, accurate results
  - Readings are displayed in approximately 1.5 seconds
- Single-point calibration
  - Calibrate with distilled or deionized water
- Small sample size
  - Sample size can be as small as 2 metric drops
- Automatic shut-off
  - After three minutes of non-use
- Stainless steel sample well
  - Easy to clean and corrosion-resistant
- ABS thermoplastic casing



## Ideal for Seawater Analysis

Hanna's HI96822 Digital Refractometer is a rugged, portable, water resistant device that utilizes the measurement of the refractive index to determine the salinity of natural and artificial seawater, ocean water or brackish intermediates. The HI96822 reflects Hanna's years of experience as a manufacturer of analytical instruments. This digital refractometer eliminates the uncertainty associated with mechanical refractometers and is durable and compact enough to be used at home, in the lab, or out in the field.

The HI96822 is an optical device that is quick and easy to use. After a simple user calibration with distilled or deionized water, a seawater sample can be introduced into the sample well.

Within seconds, the refractive index and temperature are measured and converted into one of three popular measurement units: Practical Salinity Units (PSU), parts per thousand (ppt), or specific gravity (S.G. (20/20)). All conversion algorithms are based upon respected scientific publications using the physical properties of seawater.

## The Importance of Salinity Measurement Throughout a Variety of Applications

Salinity is a critical measurement in many applications, such as aquaculture, environmental monitoring, aquariums, desalination plants, well water, and many more. Until now, the available technology to measure salinity has relied on mechanical instruments, such as hydrometers and mechanical refractometers, or on high-tech conductivity meters. While easy to use, getting a reading on a mechanical refractometer can be difficult since they are highly susceptible to changes in temperature. Hydrometers, though inexpensive, are typically made of glass and subject to breakage.

The Hanna HI96822 is the solution to all these issues. It is lightweight, easy to use, cost-efficient, and extremely accurate. With the ability to read in three of the most widely used salinity units (PSU, ppt, and Specific Gravity), it is the ideal instrument for any application.

# Easy to Operate

## Start-up Screens

When the HI96822 is turned on, all of the LCD segments will be displayed followed by the percentage of battery life remaining.

## Calibration

Perform a quick and easy calibration after start-up:

1. Using a plastic pipette, completely cover the prism in the sample well with distilled or deionized water.
2. Press the ZERO key.

## Unit Selection

Just press the RANGE key to cycle through the HI96822's units of measurement. PSU, ppt, Specific Gravity (20/20).

## Measurement

Achieve fast, professional results:

1. Using a plastic pipette, drip sample onto the prism surface until the well is full.
2. Press the READ key and the results are displayed in the selected units.

## Making a Standard Sodium Chloride Solution

Sodium Chloride solutions can be used to check the accuracy of the meter. The table below lists two Sodium Chloride solutions and their expected ppt Seawater value. To make a Standard NaCl Solution (g/100 g), follow the procedure below:

- Place container (such as a glass vial or dropper bottle that has a cover) on an analytical balance.
- Tare the balance.
- To make an X NaCl solution weigh out X grams of high purity dried Sodium Chloride (CAS #: 7647-14-5; MW 58.44) directly into the container.
- Add distilled or deionized water to the beaker so the total weight of the solution is 100g.

Example Standard NaCl solution:

	NaCl (g)	Water (g)	Total	Expected Seawater Value (ppt)
3.5% NaCl	3.50	96.50	100.000	34
10% NaCl	10.00	90.00	100.000	96

Specifications	HI96822	
PSU	Range	0 to 50
	Resolution	1
	Accuracy (@25°C/77°F)	±2
ppt	Range	0 to 150
	Resolution	1
	Accuracy (@25°C/77°F)	±2
Specific Gravity (S.G.)	Range	1.000 to 1.114
	Resolution	0.001
	Accuracy (@25°C/77°F)	±0.002
Temperature	Range	0 to 80°C (32 to 176°F)
	Resolution	0.1°C (0.1°F)
	Accuracy (@25°C/77°F)	±0.3°C (0.5°F)
Additional Specifications	Temperature Compensation	automatic between 0 and 40°C (32 to 104°F)
	Measurement Time	approximately 1.5 seconds
	Minimum Sample Volume	100 µL (to cover prism totally)
	Light Source	yellow LED
	Sample Cell	stainless steel ring and flint glass prism
	Auto-off	after three minutes of non-use
	Enclosure Rating	IP65
	Battery Type / Life	9V / approximately 5000 readings
	Dimensions	192 x 102 x 67 mm (7.6 x 4.01 x 2.6")
Weight	420 g	
Ordering Information	HI96822 is supplied with battery and instruction manual.	

## Some specific examples of the importance of salinity:

**Aquaculture:** Young salmon start their lives in fresh water. As they mature, they reach a stage ("smolt") when they transition to salt water. When farming salmon, it is critically important to maintain proper salinity levels at each life stage to prevent unnecessary stress that could negatively affect growth and development.

Salinity is a vital parameter to monitor accurately when raising eggs and larval fish, optimizing juvenile and adult growth, and culturing live food such as rotifers and artemia.

**Aquaria:** Whether it is the world-renowned, eight million gallon Georgia Aquarium, or a 20 gallon reef tank at home, salinity is a crucial parameter to measure. In closed systems such as these, salinity is easily affected. As water evaporates, it leaves the salt behind, raising the salinity. When evaporated water is replaced with fresh water, the salinity is lowered. The potential for disaster is inherent in both situations. Use Hanna's digital refractometer to accurately measure salinity and to help prevent any mishaps.

HI96831 · HI96832

# Digital Refractometers

for Ethylene and Propylene Glycol Analysis

- 0 to -50 °C freezing point range with  $\pm 0.5$  °C accuracy
- Dual-level LCD
  - Displays measurement and temperature readings simultaneously
- Automatic Temperature Compensation (ATC)
- Easy measurement
  - Place a few drops of the sample in the well and press the READ key
- BEPS
  - Alerts the user of low battery power that could adversely affect readings
- IP65 water protection
  - Built to perform under harsh laboratory and field conditions.
- Quick, accurate results
  - Readings are displayed in approximately 1.5 seconds
- Single-point calibration
  - Calibrate with distilled or deionized water
- Small sample size
  - Sample size can be as small as 2 metric drops
- Automatic shut-off
  - After three minutes of non-use
- Stainless steel sample well
  - Resists corrosion from salt water
- ABS thermoplastic casing

HI96831 for Ethylene Glycol and HI96832 for Propylene Glycol are rugged, portable, water-resistant Digital Refractometers that utilize the measurement of the refractive index to determine the percent volume and freezing point of ethylene and propylene glycol based solutions respectively.

These digital refractometers eliminate the uncertainty associated with mechanical refractometers. Samples are measured after a simple user calibration with distilled or deionized water. Within seconds, the refractive index and temperature are measured and converted into one of two measurement units; % volume or freezing point. Both meters use internationally recognized references for unit conversion and temperature compensation for glycol solutions (e.g. CRC Handbook of Chemistry and Physics, 87th Edition).



Specifications	HI96831 Ethylene Glycol	HI96832 Propylene Glycol	
% Volume (% v/v)	Range	0 to 100%	0 to 100%
	Resolution	0.1 %	0.1 %
	Accuracy (@25°C/77°F)	$\pm 0.2$ %	$\pm 0.3$ %
Freezing Point (FP)	Range	0 to -50°C (32 to -58°F)	0 to -51°C (32 to -59.8°F)
	Resolution	0.1°C (0.1°F)	0.1°C (0.1°F)
	Accuracy (@25°C/77°F)	$\pm 0.5$ °C ( $\pm 1.0$ °F)	$\pm 0.5$ °C ( $\pm 1.0$ °F)
Temperature	Range	0 to 80°C (32 to 176°F)	0 to 80°C (32 to 176°F)
	Resolution	0.1°C (0.1°F)	0.1°C (0.1°F)
	Accuracy (@25°C/77°F)	$\pm 0.3$ °C ( $\pm 0.5$ °F)	$\pm 0.3$ °C ( $\pm 0.5$ °F)
Additional Specifications	Temperature Compensation	automatic between 0 and 40°C (32 to 104°F)	
	Measurement Time	approximately 1.5 seconds	
	Minimum Sample Volume	100 $\mu$ L (to cover prism totally)	
	Light Source	yellow LED	
	Sample Cell	stainless steel ring and flint glass prism	
	Auto-off	after three minutes of non-use	
	Enclosure Rating	IP65	
	Battery Type / Battery Life	9V / approximately 5000 readings	
	Dimensions / Weight	192 x 102 x 67 mm (7.6 x 4.01 x 2.6") / 420 g (14.8 oz.)	
Ordering Information	HI96831 and HI96832 are supplied with battery and instruction manual.		



Introduction.....	14.2	Dataloggers .....	14.42
Product Spotlights.....	14.6	Waterproof Thermologger .....	14.42
Comparison Guides.....	14.6	T-Logger .....	14.44
Portable.....	14.7	Relative Humidity (RH)	
Thermocouple Thermometers .....	14.7	Meters.....	14.45
Thermocouple Probes.....	14.11		
Thermistor Thermometers .....	14.20		
Thermistor Probes.....	14.21	Lux (Light) Meter .....	14.46
Foodcare Thermometers			
Introduction.....	14.23		
Thermistor Beer Line			
Thermometers .....	14.26		
Thermistor Foodcare			
Thermometers .....	14.28		
Thermistor Foodcare			
Probes .....	14.29		
Thermocouple Foodcare			
Thermometers .....	14.30		
Thermocouple Foodcare			
Probes .....	14.35		



## About Thermometers

Precise process control is one of the most important factors in maintaining high quality in production, just as precision and accuracy are the key to research. Temperature is a crucial variable in both production and research.

Glass and metal thermometers use thermal expansion to measure temperature. This method uses a physical law which gives a false sense of reliability, since one assumes the measurement is “true” because he or she can see how it works. This system is no longer suitable for many reasons and their accuracy and range are very limited. Glass construction is fragile and can be dangerous to a person’s health, as well as to the environment. For these reasons, an alternative way of measuring temperature has become necessary. Hanna electronic thermometers are designed to withstand mechanical stress and extreme environments while maintaining high accuracy.

Electronic thermometers have provided the versatility, speed and accuracy requested by operators in all areas of temperature measurement. Speed is important when the reactions being monitored change rapidly. Small, compact sensors are preferable for tightly arranged areas, such as electronics and other miniature applications. Electronic thermometers allow users to monitor maximum, minimum and even average temperatures.

Dedicated research teams, precision process control, integrated production facilities and an overall team effort is required to meet the demanding applications of our users. Hanna’s extensive professional thermometer line constitutes the true dedication Hanna commits to thermometer design and production.

## Measurement Unit

Temperature is one of the most common physical properties in our everyday life. It is defined as the property of a body that determines the transfer of heat to or from other bodies. Physically, temperature affects variations in the macroscopic parameters of a body such as volume and pressure, among others.

The fundamental temperature scale is the absolute, thermodynamic or Kelvin scale. The Kelvin (K) unit of thermodynamic temperature, is the fraction 1/273.16 of thermodynamic temperature of the triple point of water. The triple point of water is a standard fixed point at which ice, liquid water, and water vapor are in equilibrium.

Two empirical temperature scales are in common use: the Celsius and Fahrenheit scales. These scales are based on two fixed points.

The Celsius (formally Centigrade) temperature scale uses the Celsius (°C) units, defined as 1/100th of the difference between the temperature of boiling (100°C) and freezing points (0°C) of water. The relationship between the Kelvin and Celsius scales is given by:

$$K = ^\circ C + 273.15$$

The Fahrenheit scale uses Fahrenheit (°F) units, where the temperature of boiling water is taken at 212°F, and the temperature of the freezing point at 32°F. The scale originally used the temperature of a mixture of ice and common salt as 0°F, and the inventor’s approximate body temperature as 96°F. The relationship between the Fahrenheit and Celsius scales is calculated by:

$$^\circ F = ^\circ C \cdot 9/5 + 32$$

## Achieving Thermometer Accuracy

Even though it is easy to show resolutions of 0.1°C with digital thermometers, there is no relationship between resolution and accuracy of measurements.

Here is a list of the main causes that can have an effect on accuracy in temperature measurements:

- **Instrument**
  - The instrument may have an extended scale and 19,000 points of measurement may be obtained. Within these 19,000 points, the instrument may perform differently because of internal linearity.
- **Electronic components**
  - The internal electronics have a drift that depends on the ambient temperature. For this reason, the accuracy of the instrument is stated at a specific temperature of 20 or 25°C, and the drift has to be specified for each degree of variation with respect to the reference temperature.
- **LCD**
  - Liquid crystals have an operating limitation which is a function of temperature. Their normal range is between 0 and 50°C, but there are components capable of performing between -20 and 70°C.
- **Batteries**
  - Instrument battery power supply also has limitations of use.
- **Temperature sensor**
  - This is a separate accuracy, which is to be added to the instrument’s error.

Also, if the probe supplied is connected to the meter during factory calibration, the probe error is eliminated but will reappear if the probe is replaced.

With all the possible forces influencing accuracy, calibration verification is essential. Hanna’s CAL Check™ can verify an accurate calibration quickly and easily.



## Importance of Accuracy

Up to a few years ago, accuracy was not a very critical aspect and tolerances of a few degrees did not jeopardize a process. From the time that hazard analysis and critical control points (HACCP) programs became a necessity, measurement accuracy has become a discriminating factor. Due to health risk factors, now an error of a few tenths of a degree can decide whether food can still be kept or must be discarded. In 1990, Hanna began to produce thermometers for our customers' HACCP programs to comply with new governmental regulations. Soon after, Hanna became the market leader in Europe as a result of the technological solutions offered to our users.

## User Calibration of Typical Thermometers

To calibrate typical thermometers you need:

- For thermocouple thermometers
  - A simulator of the emf (electromotive force) generated by the thermocouple
- For thermometers with NTC/PTC sensor
  - At least two thermostatic baths
- For Pt100 thermometers
  - A resistance simulator
- For infrared thermometers
  - A heat source (panel) at controlled temperature

Few users can afford this investment in time and materials for checking their thermometers' accuracy. Hanna's exclusive CAL Check is a quick and cost effective way to verify accuracy.

## Hanna CAL Check™ Calibration Feature

As previously described, the electronic components of an instrument shift with time. Hanna has made it possible for users, with the simple touch of a button, to verify whether the response of the instrument is within the tolerance limit of  $\pm 0.02^\circ\text{C}$ .

The CAL Check system acts by substituting the sensor with an internal resistor which corresponds to  $0^\circ\text{C}$ ; thus simulates the response that the temperature probe would have at  $0^\circ\text{C}$ .

## Standardization

Hanna has designed a series of pre-calibrated temperature probes with a maximum error of  $2^\circ\text{C}$  for trouble-free replacement.

## Thermocouple Thermometer Calibration

Although quite fast, thermocouple thermometers read with a response time much slower than other sensors and technologies. Unfortunately, the measurement of the thermocouple emf (electromotive force) loses accuracy because of the measuring system itself, based on the emf generated by the temperature difference between cold and hot junctions. The same emf may be generated under different conditions, for example:

- Hot junction at  $100^\circ\text{C}$ ; cold junction at  $20^\circ\text{C}$ ; difference:  $80^\circ\text{C}$   
or Hot junction at  $90^\circ\text{C}$ ; cold junction at  $10^\circ\text{C}$ ; difference:  $80^\circ\text{C}$

A temperature difference of  $80^\circ\text{C}$  is obtained with two different temperatures of the sample. It is, therefore, very important to determine the cold junction temperature very precisely. The ability to



do this has a large effect on the accuracy of the measuring system. A thermocouple thermometer is made of two thermometers, one that measures the cold junction, and one for measuring the emf generated by the thermocouple. The cold junction is usually measured with an NTC type sensor, which has response times different from those of the thermocouple. Another crucial point is measuring the actual value of the cold junction, without any environmental influence and dispersions.

To partially solve this problem, Hanna has devised the calibration of the instrument-thermocouple system by dipping the probe in melting ice, thus allowing the user to calibrate the measuring system at  $0^\circ\text{C}$ .

Thanks to this solution, it is now possible to use thermocouple thermometers for HACCP controls with an accuracy of  $\pm 0.3^\circ\text{C}$ , which is the same performance of our Pt100 or NTC thermometers, but with a higher response time.

## Calibration Test Keys

To check the calibration status of the instrument, calibrated keys have been prepared in the range from  $-18$  to  $70^\circ\text{C}$ . These keys reproduce the value of the sensor at different temperatures. Simply disconnect the measuring probe, replace it with the key and ensure that the instrument reads the simulated value.

Hanna calibrates all thermometers with a standard probe. All NTC temperature probes are inspected and calibrated with standard instruments. During quality inspection, our technicians make sure that the reading errors are within the stated accuracies.

In addition, Hanna provides users with the necessary tools to verify that your thermometers read accurate values. Our complete line of electronic thermometers provides fast and precise measurements down to a tenth of a degree Celsius.

Hanna thermometers may be divided into four main categories: thermistor thermometers, thermocouple thermometers, Pt100 thermometers and infrared thermometers.



## Thermistor Thermometers

The thermistor is a semi-conductor device whose resistivity ( $r$ ) varies as a function of temperature ( $T$ ):

$$R = R_0 [1 + a(T - T_0)]$$

where

**R = resistance of temp. at T**    **T = temp at the end of measurement**  
**R<sub>0</sub> = resistance of temp. at T<sub>0</sub>**    **T<sub>0</sub> = temp at the beginning of measurement**

Temperature resistance coefficient is the parameter that determines if the resistivity variation is positive (as with the Positive Temperature Coefficient, or PTC sensors) or negative (as with the Negative Temperature Coefficient, or NTC thermistors). It is possible to determine the temperature by applying a potential difference and measuring the resistance.

Thermistor sensors are suitable for a temperature range of -50 to 150°C (-58 to 302°F). Higher temperatures may damage the semi-conductor sensor. Accurate temperature measurements are possible (tenths of degree) due to the high sensitivity of the sensor.

## Thermocouple Thermometers

The thermocouple consists of the junction of two wires of different metals. At a given temperature, a potential difference results at the opposite extremes of the two wires (Seebeck effect), with the respective variations linearly related within small intervals. It is therefore possible to determine the temperature given the potential difference and characteristics of the two metals. The measurement end of the thermocouple probe is called the hot junction, while the connection of the thermocouple to the meter is the cold junction. An error is introduced as the cold junction is exposed to the ambient temperature. This error can be eliminated by physically putting the cold junction into an ice bath and forcing a reference temperature of 0°C, or by electronically compensating for the cold junction temperature effect. There are various types of thermocouples, identified by an ANSI code using a letter of the alphabet. The K type is the most commonly used thermocouple.

## Pt100 Thermometers

The operating principle of resistance thermometers is based on the increase of electric resistance of metal conductors (RTD: Resistance Temperature Detectors) with temperature.

This physical phenomenon was discovered by Sir Humphry Davy in 1821. In 1871, Sir William Siemens described the application of this property using platinum, thereby introducing an innovation in the manufacturing of temperature sensors. Platinum resistance thermometers have been used as an international standard for measuring temperatures between hydrogen triple point at 13.81 K and the freezing point of antimony at 630.75°C (1167.26°F).

Among the various metals to be used in the construction of resistance thermometers, platinum (Pt), a noble metal, is the one that can measure temperatures throughout a wide range; from -251°C (-419.8°F) to 899°C (1650.2°F), with a linear behavior.

Platinum RTD thermometers were common in the seventies but have now been replaced with thermistor sensors because of their smaller dimensions and faster response to temperature changes. The most common RTD sensor using platinum is the Pt100, which means a resistance of 100Ω at 0°C with a temperature coefficient of 0.00385Ω per degree Celsius. For a higher price one can buy platinum sensors with 250, 500 or 1000/(Pt1000).

The main disadvantage of RTD probes is the resistance of the connection cable. This resistance prevents the use of standard two-wire cables for lengths over a few meters, since it affects the accuracy of the reading. For this reason, to obtain high levels of accuracy in industrial and laboratory applications, the use of a three or four-wire system is recommended.

For all its Pt100 thermometers and probes, Hanna has chosen the multiple-wire technology for higher accuracy.

## Infrared Thermometers

All objects emit a radiant energy in the infrared (IR) spectrum that falls between visible light and radio waves.

The origins of IR measurements can be traced back to Sir Isaac Newton's prism and the separation of sunlight into colors and electromagnetic energy. In 1800, the relative energy of each color was measured, but it was not until early 20th century that IR energy was quantified. It was then discovered that this energy is proportional to the 4th power of the object's temperature.

IR instrumentation using this formula has been around for over 50 years. They almost exclusively use an optic device that detects the heat energy generated by the object that the sensor is aimed at. This is then amplified, linearized and converted into an electronic signal which in turn shows the surface temperature in Celsius or Fahrenheit degrees.

Infrared measurements are particularly suitable for areas where it is difficult or undesirable to take surface measurements using conventional contact sensors. Applications for IR meters include non-destructive testing of foodstuffs, moving machinery, and high temperature surfaces.



An ideal surface for IR measurements is a black body or radiator with an emissivity of 1.0. Emissivity is the ratio of the energy radiated by an object at a certain temperature to that emitted by a perfect radiator at the same temperature.

The shinier or more polished the surface, the less accurate the measurements. For example, the emissivity of most organic material and rough or painted surfaces is in the 0.95 region and hence, suitable for IR measurements.

On the other hand, surfaces of highly polished or shiny material, such as mirrors or aluminum, may not be appropriate for this application without using some form of filtration. This is due to other factors, namely, reflectivity and transmissivity. The former is a measure of an object's ability to reflect infrared energy while the latter is its ability to transmit it.

Another important and practical concern with IR measurements is the field of view. Infrared meters measure the average temperature of all objects in their field of view. To obtain an accurate result, it is important that the object completely fills the instrument's field of view and there are no obstacles between the meter and the object. The distance-to-target ratio, or the optic coefficient, is therefore an important consideration.



## Reference Temperatures

In 1990, NIST established 17 fixed points of the International Temperature Scale (ITS-90) related to reproducible physical phenomena in nature. The ITS-90 Fixed Points are shown in the chart below:

Equilibrium state	K	°C
Vapor pressure point of helium	3 to 5	-270.15 to -268.19
Triple point of hydrogen	13.8033*	-259.346*
Boiling point of hydrogen at a pressure of 33.330.6 Pa	17.042*	-256.108*
Boiling point of equilibrium hydrogen	20.28*	-252.87*
Triple point of neon	27.102	-246.048
Triple point of oxygen	54.361	-218.789
Triple point of argon	83.8058	-189.3442
Triple point of mercury	234.3156	-38.8344
Triple point of water	273.16	0.01
Triple point of gallium	302.9146	29.7646
Melting point of indium	429.7485	156.5985
Melting point of tin	505.078	231.928
Melting point of zinc	692.677	419.527
Melting point of aluminum	933.473	660.323
Melting point of silver	1234.93	961.78
Melting point of gold	1337.33	1064.18
Melting point of copper	1357.77	1084.62

\* Given for e-H<sub>2</sub>, which is hydrogen at the equilibrium concentration of the orth and para molecular forms.



HI148 Series

## Waterproof Thermologgers

The HI148 series of thermologgers are ideal for monitoring temperature in applications such as food processing, transportation, museums, and horticulture.

See page 14.42



HI935012

## Brewing Thermometer

with 1 m stainless steel probe

See page 14.26

## Comparison Guides

	K-type	T-type	K,J,T - type	Range	CAL Button	CAL Check™	PC Compatibility	BEPS	HOLD Feature	Waterproof	Autoranging	Logging	Alarm	Interchangeable Probe	Multiple Channels	Backlit LCD	Foodcare	Page
--	--------	--------	--------------	-------	------------	------------	------------------	------	--------------	------------	-------------	---------	-------	-----------------------	-------------------	-------------	----------	------

## Thermocouple Thermometers

HI935005	•			°C/°F				•	•	•				•				14.7
HI935002	•			°C/°F				•	•	•				•	•			14.8
HI93531	•			°C/°F				•	•	•				•				14.9
HI93531N	•			°C/°F	•			•	•	•				•		•		14.9
HI935003	•			°C/°F		•				•				•				14.10
HI935001	•			°C/°F		•				•				•			•	14.30
HI935004		•		°C/°F		•				•				•			•	14.31
HI935007	•			°C/°F		•				•							•	14.34
HI9350011	•			°C/°F		•				•							•	14.32
HI9350041	•			°C/°F		•				•							•	14.33

## Thermistor Thermometers

HI93510				°C/°F				•	•	•				•				14.20
HI93510N			•	°C/°F				•	•	•				•		•		14.20
HI935012				°C/°F		•				•				•			•	14.26
HI93501				°C/°F		•				•				•			•	14.28

## Temperature Dataloggers

HI148				°C/°F		•	•			•		•			•			14.42
HI144				°C/°F		•						•	•					14.44



HI935005

## K-Type Thermocouple Thermometers

- **°C/°F Readout**
  - Measurements can be displayed in either degrees Celsius or Fahrenheit. A simple press of the °C/°F button will switch between the scales.
- **Interchangeable Probes**
  - A wide range of K-type thermocouple probes are available to meet the specific needs of users. Any of the HI766 series of probes can be interchanged with the HI935005 to measure temperature of surfaces, gases, air, liquid, semi-solid samples, and more.
- **High/Low Function**
  - The maximum and minimum temperature values are continuously monitored and displayed on the lower portion of the HI935005 LCD display during a measurement session. The CLR button clears the high and low values on the LCD display.
- **HOLD Function**
  - The HOLD button on the face of the meter freezes the display to allow the user time to record readings. Although the display is frozen, the meter continues to internally monitor the temperature and update the high and low measurement values.
- **Auto Shut-off**
  - Users can select to enable automatic shut off after 8 or 60 minutes of non-use or select to disable the shut-off feature.
- **Battery Error Prevention System (BEPS)**
  - The Battery Error Prevention System detects when the batteries become too weak to ensure reliable measurements.
- **Low Battery Indicator**
  - When the battery level is below 10%, a warning symbol will blink to indicate low battery condition.

The HI935005 is a K-type thermocouple thermometer that can be used with a wide variety of K-type probes. This thermometer offers two measurement ranges from -50.0 to 199.9°C and 200 to 1350°C which can also be displayed in °F (-58.0 to 399.9°F and 400 to 2462°F). With a ±0.2% full scale accuracy, the HI935005 waterproof thermometers are perfectly suited for temperature measurements in the laboratory or the field.

Specifications	HI935005
Range	-50.0 to 199.9°C and 200 to 1350°C; -58.0 to 399.9°F and 400 to 2462°F
Resolution	0.1°C (-50.0 to 199.9°C) and 1°C (outside); 0.1°F (-58.0 to 399.9°F) and 1°F (outside)
Accuracy	±0.2% FS (excluding probe error)
Probe	HI766 series K-type thermocouple (not included)*
Battery Type / Life	1.5V AA (3) / approximately 1600 hours of continuous use; auto-off selectable after 8 or 60 minutes of non-use (can be disabled)
Environment	-10 to 50°C (14 to 122°F); RH max 100%
Dimensions	150 x 80 x 36 mm (5.9 x 3.1 x 1.4")
Weight	235 g (8.3 oz.)
<b>Ordering Information</b>	<b>HI935005</b> is supplied with batteries and instruction manual.
<b>Probes</b>	<b>HI766C</b> Penetration, stainless steel K-type thermocouple temperature probe with 1 m cable
	<b>HI766D</b> Air/gas, stainless steel K-type thermocouple temperature probe with 1 m (3.3') cable
	<b>HI766E1</b> General purpose/penetration, stainless steel K-type thermocouple temperature probe with 1 m (3.3') cable
<b>Accessories</b>	<b>HI710007</b> blue shockproof rubber boot
	<b>HI710008</b> orange shockproof rubber boot

\*K-type thermocouple probes should be ordered separately to meet your specific application.

Thermocouple probes begin on page 14.11

HI935002

## Dual-channel, K-Type Thermocouple Thermometer

- **Multiple input channels**
  - Dual input channels
- **HOLD**
  - HOLD function
- **BEPS**
  - Alerts the user of low battery power that could adversely affect readings
- **Battery indicator**
  - Battery life indicator at startup
- **Waterproof**
  - Compact, heavy-duty and waterproof

HI935002 is a 2-channel, waterproof, K-type thermometer that offers accurate temperature measurements in a wide range, as well as 1600 hours of battery life.

These units display current temperature along with the minimum and maximum temperature for each channel achieved during the measuring session. The difference between each channel can be shown, or a relative value can be set on each channel and variances around that value can be monitored.

The HOLD button freezes the display to allow the user time to record readings.

The instruments are equipped with BEPS (Battery Error Prevention System), which alerts the user in the event that low battery power could adversely affect readings.



Specifications	HI935002
Range	-50.0 to 199.9°C and 200 to 1350°C; -58.0 to 399.9°F and 400 to 2462°F
Resolution	0.1°C (-50.0 to 199.9°C) and 1°C (outside); 0.1°F (-58.0 to 399.9°F) and 1°F (outside)
Accuracy	±0.2% f.s. (for 1 year, excluding probe error)
Probe	HI766 series K-type thermocouple (not included)*
Battery Type / Life	1.5V AA (3) / approx. 1600 hours of continuous use
Environment	-10 to 50°C (14 to 122°F); RH max 100%
Dimensions	150 x 80 x 36 mm (5.9 x 3.1 x 1.4")
Weight	235 g (8.3 oz.)
<b>Ordering Information</b>	<b>HI935002</b> is supplied with batteries and instructions.
<b>Probes</b>	<b>HI766C</b> Penetration, stainless steel K-type thermocouple temperature probe with 1 m cable
	<b>HI766D</b> Air/gas, stainless steel K-type thermocouple temperature probe with 1 m (3.3') cable
	<b>HI766E1</b> General purpose/penetration, stainless steel K-type thermocouple temperature probe with 1 m (3.3') cable
<b>Accessories</b>	<b>HI710007</b> blue shockproof rubber boot
	<b>HI710008</b> orange shockproof rubber boot

\*K-type thermocouple probes should be ordered separately to meet your specific application.



HI93531 · HI93531N

## 0.1° Resolution K-Type Thermocouple Thermometers

- **HOLD**
  - HOLD function
- **BEPS**
  - Alerts the user of low battery power that could adversely affect readings
- **Battery indicator**
  - Battery life indicator at startup
- **Backlight**
  - Backlit display (N and R versions)
- **Waterproof**
  - Compact, heavy-duty and waterproof
- **Connectivity**
  - PC and printer compatible (R version)

These waterproof thermometers feature 0.1° resolution in the -149.9 to 999.9°C (-24.9 to 999.9°F) range, making them ideal for precise temperature measurements. The instruments display the current temperature along with the minimum and maximum extremes achieved.

The HOLD button freezes the display to allow the user time to record readings. The °C/°F button switches between the Celsius and Fahrenheit temperature scale. The CLR button restarts the evaluation of high and low values.

The HI93531N features a user-activated backlight for low or no light conditions. The CAL button allows a simple one-point calibration in an ice bath at 0°C when probe interchange occurs.

The instruments are equipped with BEPS (Battery Error Prevention System), which alerts the user in the event that low battery power could adversely affect readings.

Specifications	HI93531	HI93531N
Range	-200.0 to 999.9°C; 1000 to 1371°C	-328.0 to 999.9°F; 1000 to 2500°F
Resolution	0.1°C (-149.9 to 999.9°C); 0.2°C (-200.0 to -150.0°C); 1°C (outside)	0.1°F (-24.9 to 999.9°F); 0.2°F (-249.9 to -25.0°F); 0.3°F (-328.0 to -250.0°F); 1°F (outside)
Accuracy	±0.5°C (-100.0 to 999.9°C); ±1°C (outside); ±1°F (-148.0 to 999.9°F); ±1.5°F (outside) (for 1 year, excluding probe error)	
Probe	HI766 series K-type thermocouple (not included)*	
CAL Button	N/A	yes
Backlit LCD	N/A	yes
RS232	N/A	N/A
Battery Type / Life	1.5V AA (3) / approximately 500 hours of continuous use (with backlight off); auto-off after 60 minutes of non-use (can be disabled)	
Environment	-10 to 60°C (14 to 122°F); RH max 100%	
Dimensions	150 x 80 x 36 mm (5.9 x 3.1 x 1.4")	
Weight	235 g (8.3 oz.)	
<b>Ordering Information</b>	<b>HI93531</b> and <b>HI93531N</b> are supplied with batteries and instructions.	
<b>Probes*</b>	<b>HI766C</b>	Penetration, stainless steel K-type thermocouple temperature probe with 1 m cable
	<b>HI766D</b>	Air/gas, stainless steel K-type thermocouple temperature probe with 1 m (3.3') cable
	<b>HI766E1</b>	General purpose/penetration, stainless steel K-type thermocouple temperature probe with 1 m (3.3') cable
<b>Accessories</b>	<b>HI710007</b>	blue shockproof rubber boot
	<b>HI710008</b>	orange shockproof rubber boot

\*K-type thermocouple probes should be ordered separately to meet your specific application.

HI935003

## K-Type Thermocouple Thermometer

- Compatible with K-type thermocouple probes
- CAL Check™ feature
- Remaining battery life indication/ low battery detection
- Auto-off
- IP65 Waterproof casing

HI935003 is designed for the measurement of industrial and domestic applications as well as farm and field temperatures.

This thermometer is compatible with K-type thermocouple probes to provide the greatest accuracy and offers a large range of temperature measurement; from -50 to 300°C (-58.0 to 572°F).

Features include waterproof casing (rated IP65), CAL Check, low battery detection, auto-off capability, and long battery life.



Our optional HI710027 blue shockproof rubber boot offers maximum impact protection.

Specifications	HI935003
Range*	-50.0 to 199.9°C / 200 to 300°C; -58.0 to 399.9°F / 400 to 572°F
Resolution	0.1°C (-50.0 to 199.9°C) / 1°C (200 to 300°C); 0.1°F (-58.0 to 399.9°F) / 1°F (400 to 572°F)
Meter Accuracy (@ 23.0°C ±5°C)	±0.4 °C (-50.0 to 300 °C) ±0.7 °F (-58.0 to 572 °F)
Response time for 90% of final value	20 seconds
Battery Type / Life	1.5V AAA (3) / approximately 3500 hours of continuous use; user-selectable auto-off after 8 or 60 minutes of non-use (can be disabled).
Environment	Rated operating condition: -20 to 50 °C (-4 to 122 °F)
	limiting condition: -30 to 50°C (-22 to 122°F)
	storage and transportation condition: -40 to 70°C (-40 to 158°F)
relative humidity 100 %	
Storage/transport temperature	-40 to 70°C (-40 to 158°F)
Dimensions	140 x 57 x 28 mm (5.5 x 2.2 x 1.1")
Mass	178 g (6.27 oz.)
<b>Ordering Information</b>	<b>HI935003</b> is supplied with 1.5V AAA batteries (3), quality certificate, and instructions.
<b>Probes</b>	<b>HI766C</b> Penetration, stainless steel K-type thermocouple temperature probe with 1 m cable
	<b>HI766D</b> Air/gas, stainless steel K-type thermocouple temperature probe with 1 m (3.3') cable
	<b>HI766E1</b> General purpose/penetration, stainless steel K-type thermocouple temperature probe with 1 m (3.3') cable

\* The measurement range applies to the probe shaft.



## General Specifications

## Accuracy

±1.5°C (up to 375°C)

±0.004 x T °C (above 375°C)

HI766E1

## General Purpose Probe

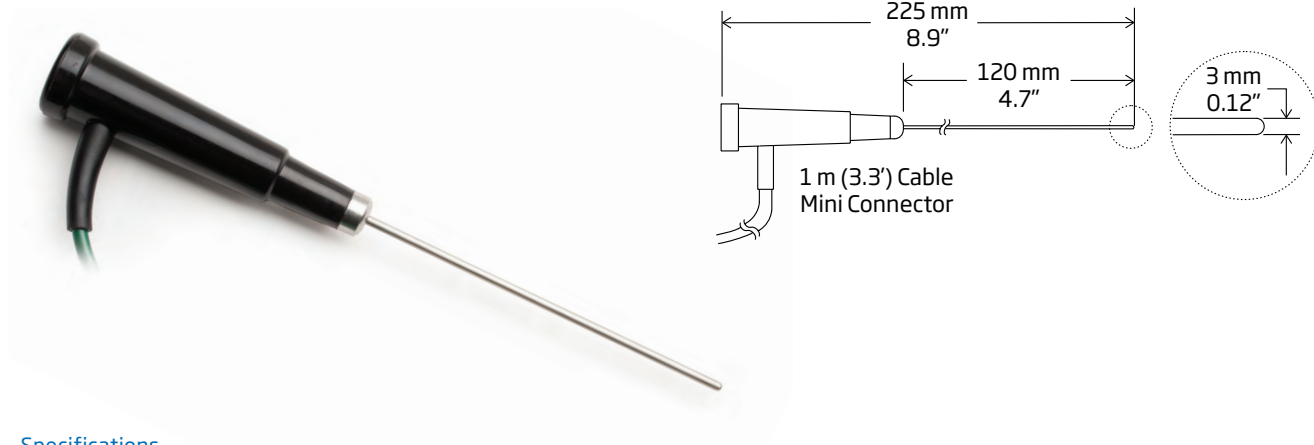

## Specifications

Code	Max. Temperature	Response time (90% of final value)	Probe Dimensions	Probe Material	Probe Handle	Probe Handle Color	Cable Type	Cable Color/Length	Connector Type
HI766E1	900°C (1650°F)	17 seconds	L 120 mm x dia 3 mm (4.7 x 0.12")	stainless steel	Polypropylene (PP)	Black	Polyurethane (PUR)/coiled	green / 1 m (3.3') cable	K-Type

HI766E2

## General Purpose Probe

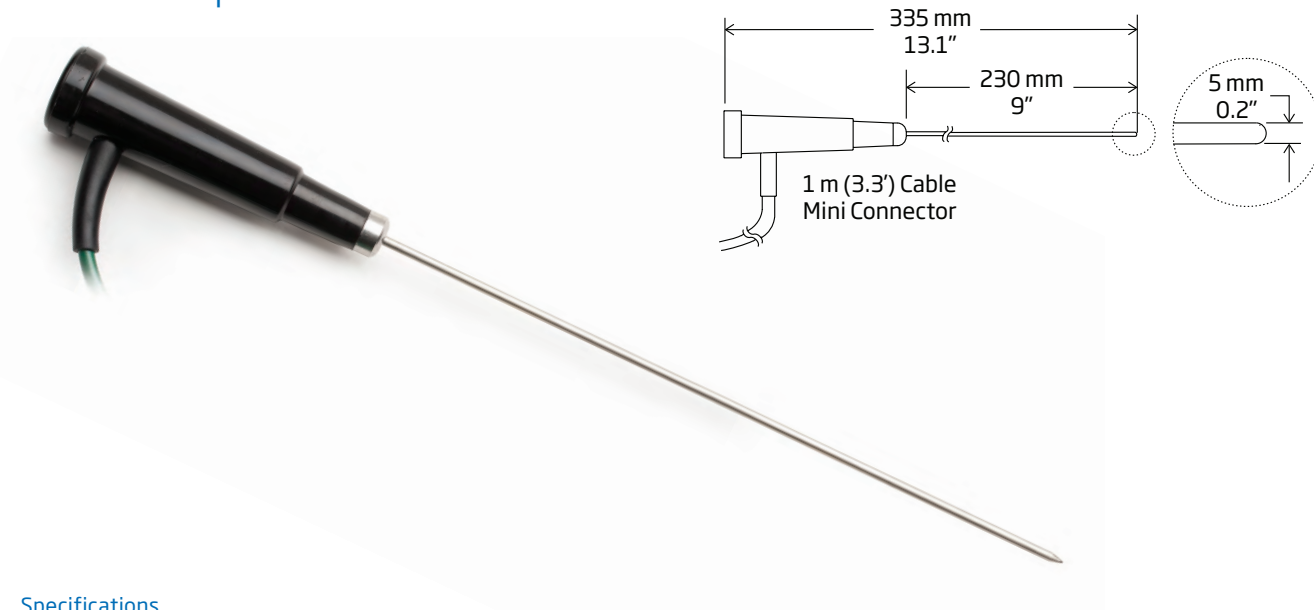

## Specifications

Code	Max. Temperature	Response time (90% of final value)	Probe Dimensions	Probe Material	Probe Handle	Probe Handle Color	Cable Type	Cable Color/Length	Connector Type
HI766E2	900°C (1650°F)	35 seconds	L 230 mm x dia 5 mm (9.0 x 0.2")	stainless steel	Polypropylene (PP)	Black	Polyurethane (PUR)/coiled	green / 1 m (3.3') cable	K-Type

# HI766 K-Type Thermocouple Probes

### General Specifications

Accuracy
±1.5°C (up to 375°C)
±0.004 x T °C (above 375°C)

HI766D  
Air and Gas Probe

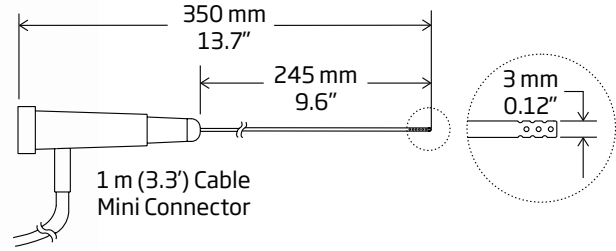

### Specifications

Code	Max. Temperature	Response time (90% of final value)	Probe Dimensions	Probe Material	Probe Handle	Probe Handle Color	Cable Type	Cable Color/Length	Connector Type
HI766D	300°C (570°F)	5 seconds	L 245 mm x dia 3 mm (9.6 x 0.12")	stainless steel	Polypropylene (PP)	Black	Polyurethane (PUR)/coiled	green / 1 m (3.3') cable	K-Type

HI766C  
Penetration Probe

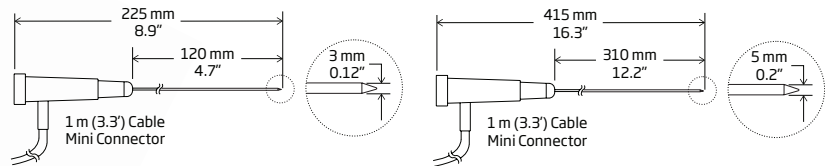
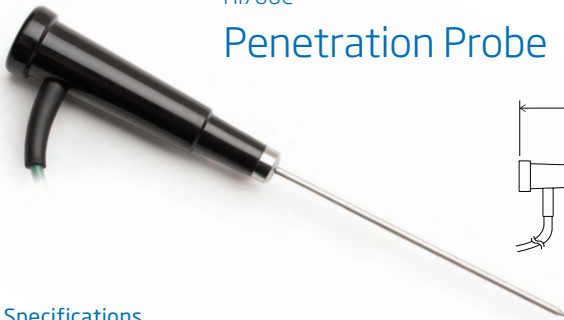

### Specifications

Code	Max. Temperature	Response time (90% of final value)	Probe Dimensions	Probe Material	Probe Handle	Probe Handle Color	Cable Type	Cable Color/Length	Connector Type
HI766C	900°C (1650°F)	15 seconds	L 120 mm x dia 3 mm (4.7 x 0.12")	stainless steel	Polypropylene (PP)	Black	Polyurethane (PUR)/coiled	green / 1 m (3.3') cable	K-Type
HI766CL	900°C (1650°F)	10 seconds	L 310 mm x dia 5 mm (12.2 x 0.2")	stainless steel	Polypropylene (PP)	Black	Polyurethane (PUR)/coiled	green / 1 m (3.3') cable	K-Type

HI766C1  
Ultra-Fast Penetration Probe

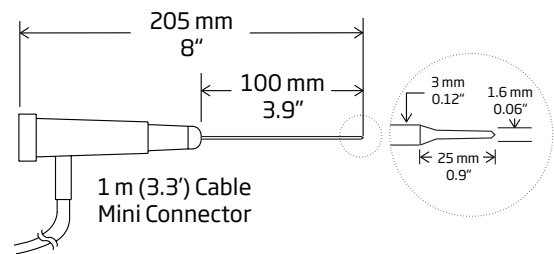

### Specifications

Code	Max. Temperature	Response time (90% of final value)	Probe Dimensions	Probe Material	Probe Handle	Probe Handle Color	Cable Type	Cable Color/Length	Connector Type
HI766C1	300°C (570°F)	3 seconds	L 100 mm x dia 1.6 mm (3.9 x 0.06")	stainless steel	Polypropylene (PP)	Black	Polyurethane (PUR)/coiled	green / 1 m (3.3') cable	K-Type

General Specifications

Accuracy

±1.5°C (up to 375°C)

±0.004 x T °C (above 375°C)

# HI766 K-Type Thermocouple Probes

HI766TR1, HI766TR2, HI766TR3, HI766TR4

## Penetration Probes for Semi-Solid Samples

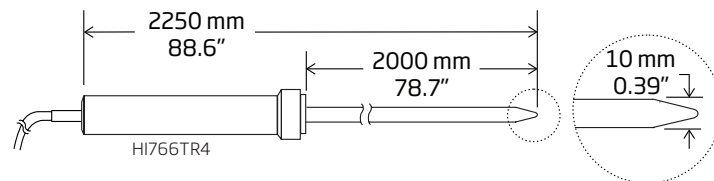
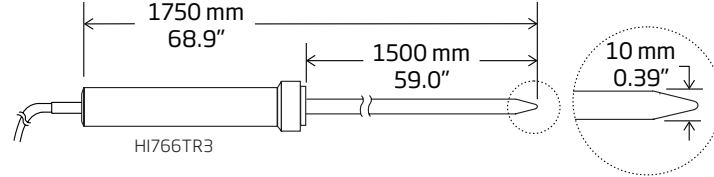
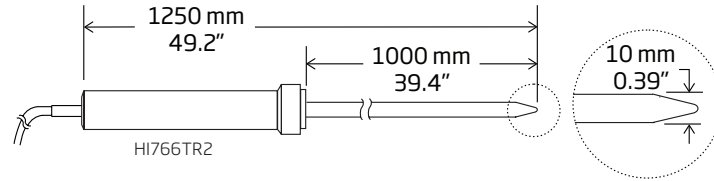
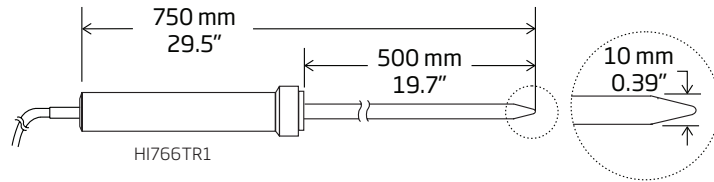

Specifications

Code	Max. Temperature	Response time (90% of final value)	Probe Dimensions	Probe Material	Probe Handle	Probe Handle Color	Cable Type	Cable Color/Length	Connector Type
HI766TR1	250°C (482°F)	14 seconds	L 500 mm x dia 10 mm (19.7 x 0.39")	stainless steel	PVC	Black	Polyurethane (PUR)/coiled	green / 1 m (3.3') cable	K-Type
HI766TR2	250°C (482°F)	14 seconds	L 1000 mm x dia 10 mm (3.3' x 0.39")	stainless steel	PVC	Black	Polyurethane (PUR)/coiled	green / 1 m (3.3') cable	K-Type
HI766TR3	250°C (482°F)	14 seconds	L 1500 mm x dia 10 mm (5' x 0.39")	stainless steel	PVC	Black	Polyurethane (PUR)/coiled	green / 1 m (3.3') cable	K-Type
HI766TR4	250°C (482°F)	14 seconds	L 2000 mm x dia 10 mm (6.6' x 0.39")	stainless steel	PVC	Black	Polyurethane (PUR)/coiled	green / 1 m (3.3') cable	K-Type

HI766

# HI766 K-Type Thermocouple Surface Probes

The following probes are designed to ensure optimal contact with surfaces of different shapes and dimensions. When using these probes, the handle temperature must never exceed 150°C (302°F) to avoid possible damage to the probe.

### General Specifications

Accuracy

±1.5°C (up to 375°C)

±0.004 x T °C (above 375°C)

HI766A

## Roller Surface Probe for Convex Surfaces

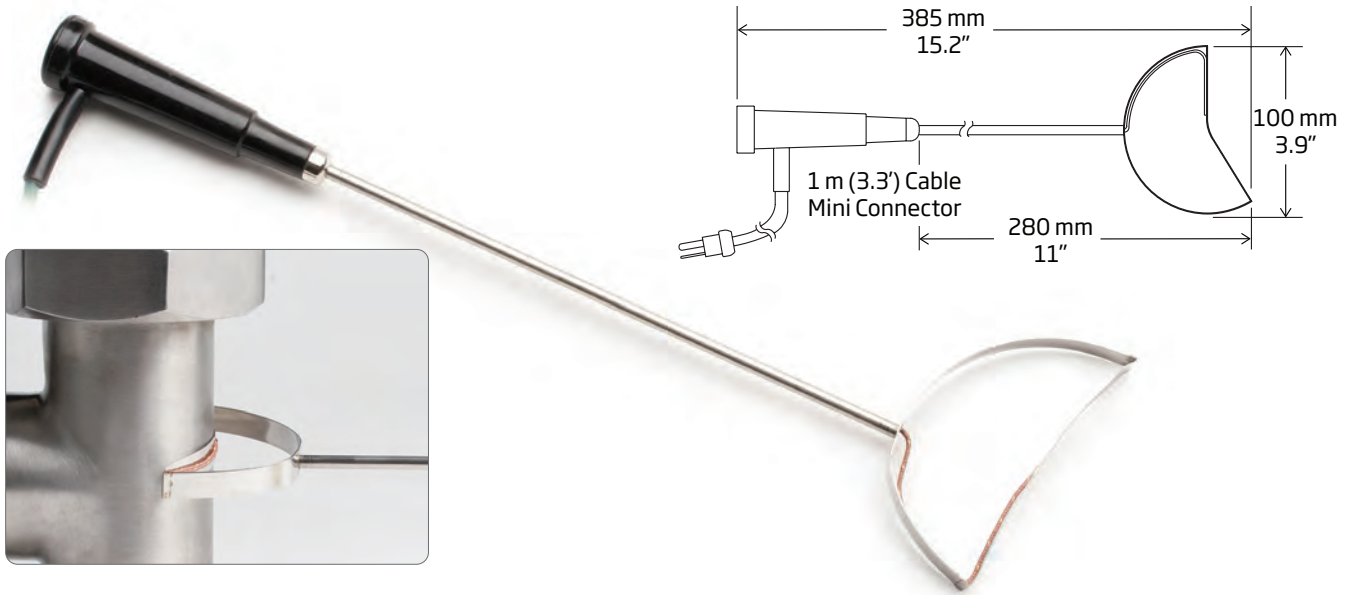

### Specifications

Code	Max. Temperature	Response time (90% of final value)	Probe Dimensions	Probe Material	Probe Handle	Probe Handle Color	Cable Type	Cable Color/Length	Connector Type
HI766A	320°C (600°F)	4 seconds	L 280 mm x 100 mm (11 x 3.9") (probe length)	stainless steel	Polypropylene (PP)	Black	Polyurethane (PUR)/coiled	green / 1 m (3.3') cable	K-Type

HI766B

## Surface Probe

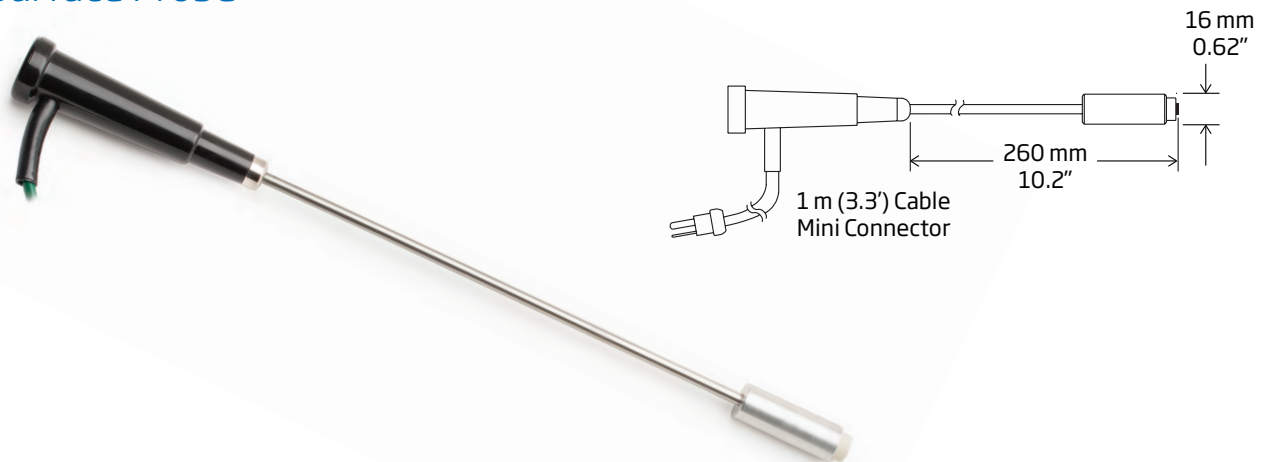

### Specifications

Code	Max. Temperature	Response time (90% of final value)	Probe Dimensions	Probe Material	Probe Handle	Probe Handle Color	Cable Type	Cable Color/Length	Connector Type
HI766B	650°C (1200°F)	8 seconds	L 260 mm x dia 16 mm (10.2 x 0.6")	stainless steel	Polypropylene (PP)	Black	Polyurethane (PUR)/coiled	green / 1 m (3.3') cable	K-Type

General Specifications

Accuracy

±1.5°C (up to 375°C)  
±0.004 x T °C (above 375°C)

# HI766 K-Type Thermocouple Surface Probes

HI766B1

## 90° Angle Surface Probe

with spring loaded sensor

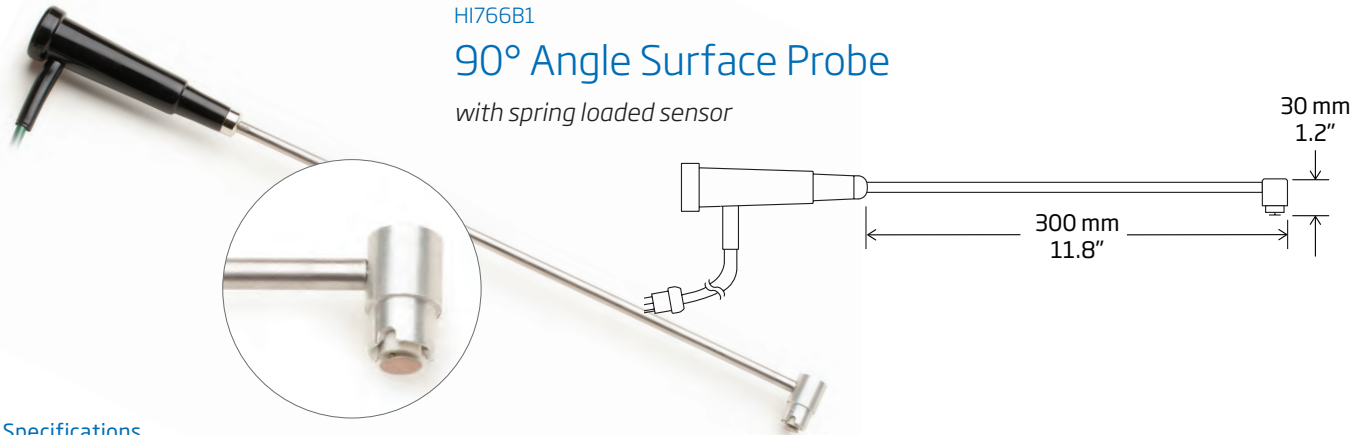

Specifications

Code	Max. Temperature	Response time (90% of final value)	Probe Dimensions	Probe Material	Probe Handle	Probe Handle Color	Cable Type	Cable Color/Length	Connector Type
HI766B1	450°C (840°F)	8 seconds	L 300 mm x dia 30 mm (11.8 x 1.2")	stainless steel	Polypropylene (PP)	Black	Polyurethane (PUR)/coiled	green / 1 m (3.3') cable	K-Type

HI766B2

## Surface Probe for Round Surfaces

with spring loaded sensor



Specifications

Code	Max. Temperature	Response time (90% of final value)	Probe Dimensions	Probe Material	Probe Handle	Probe Handle Color	Cable Type	Cable Color/Length	Connector Type
HI766B2	900°C (1650°F)	5 seconds	L 130 mm x dia 8 mm (5.1 x 0.3")	stainless steel	Polypropylene (PP)	Black	Polyurethane (PUR)/coiled	green / 1 m (3.3') cable	K-Type

HI766B3

## Surface Probe for Small Surfaces

with spring loaded sensor

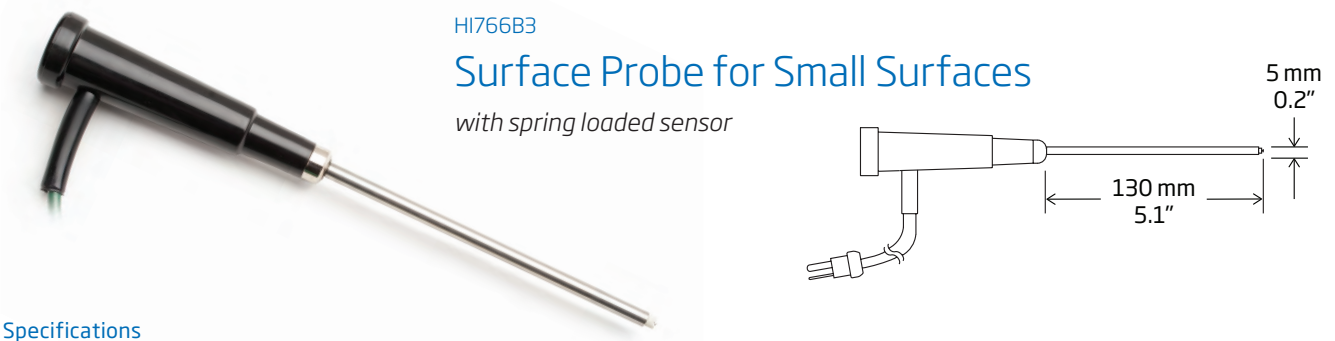

Specifications

Code	Max. Temperature	Response time (90% of final value)	Probe Dimensions	Probe Material	Probe Handle	Probe Handle Color	Cable Type	Cable Color/Length	Connector Type
HI766B3	200°C (390°F)	6 seconds	L 130 mm x dia 8 mm (5.1 x 0.3")	stainless steel	Polypropylene (PP)	Black	Polyurethane (PUR)/coiled	green / 1 m (3.3') cable	K-Type

# HI766 K-Type Thermocouple Probes without Handle

### General Specifications

Accuracy

±1.5°C (up to 375°C)  
±0.004 x T °C (above 375°C)

The HI766P series are K-type thermocouple temperature probes to be used with thermocouple thermometers. These probes are ideal for measuring samples at very high temperatures, such as in industrial applications. Probes in this section are recommended to be used with the HI766HD probe handle and/or HI766EX extension cable. All probes are made of stainless steel for long life and easy cleaning.

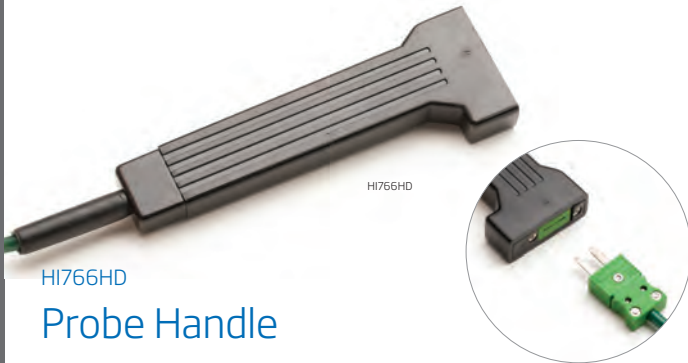

HI766HD  
Probe Handle

A rugged, PVC handle with a 1 meter (3.3') cable. It is provided with a female connector, which allows the connection of any HI766P probe.

Specifications

Code	Probe Handle	Probe Handle Color	Cable Type	Cable Color / Length	Connector Type
HI766HD	Polypropylene (PP)	black	Polyurethane (PUR)/coiled	green / 1 m (3.3')	K-Type



HI766EX  
Extension Cable

A coiled cable which extends the probe cable by 1 m (3.3'), with two connectors at the two ends (1 male and 1 female).

Specifications

Code	Cable Type	Cable Color / Length	Connector Type
HI766EX	Polyurethane (PUR)/coiled	green / 1 m (3.3')	K-Type



HI766PD  
Air and Gas Probe

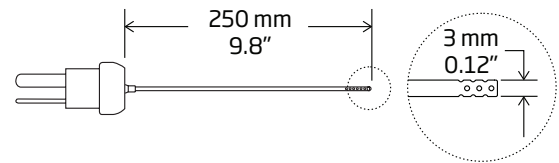

Specifications

Code	Max. Temperature	Response time (90% of final value)	Probe Dimensions	Probe Material	Connector Type
HI766PD	300°C (570°F)	5 seconds	L 250 mm x dia 3 mm (9.8 x 0.12")	stainless steel	K-Type



HI766PC  
Penetration Probe, General Purpose

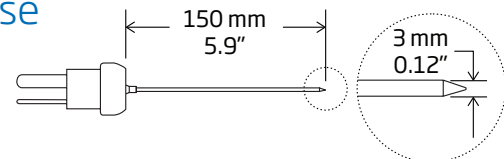

Specifications

Code	Max. Temperature	Response time (90% of final value)	Probe Dimensions	Probe Material	Connector Type
HI766PC	900°C (1650°F)	15 seconds	L 150 mm x dia 3 mm (5.9 x 0.12")	stainless steel	K-Type

General Specifications

Accuracy

±1.5°C (up to 375°C)

±0.004 x T °C (above 375°C)

# HI766 K-Type Thermocouple Probes without Handle

HI766PE1

## General Purpose Probe

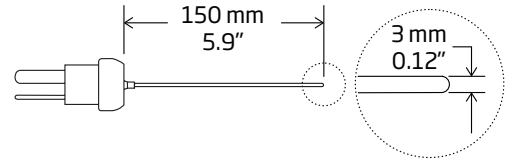
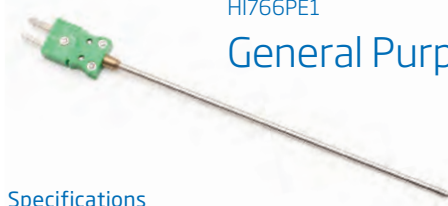

Specifications

Code	Max. Temperature	Response time (90% of final value)	Probe Dimensions	Probe Material	Connector Type
HI766PE1	900°C (1650°F)	16 seconds	L 150 mm x dia 3 mm (5.9 x 0.12")	stainless steel	K-Type

HI766PE2

## General Purpose Probe

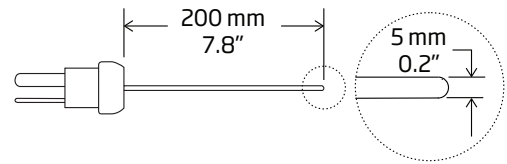
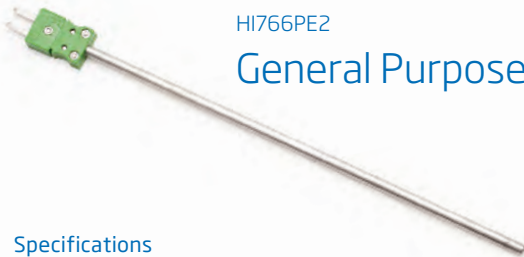

Specifications

Code	Max. Temperature	Response time (90% of final value)	Probe Dimensions	Probe Material	Connector Type
HI766PE2	900°C (1650°F)	35 seconds	L 200 mm x dia 5 mm (7.8 x 0.2")	stainless steel	K-Type

HI766PA

## Roller Surface Probe for Convex Surfaces

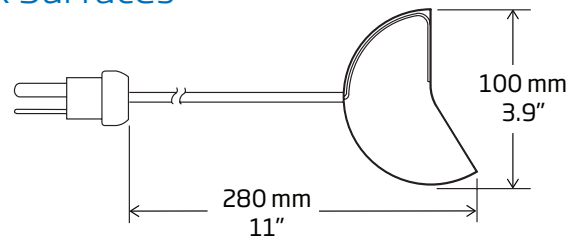

Specifications

Code	Max. Temperature	Response time (90% of final value)	Probe Dimensions	Probe Material	Connector Type
HI766PA	320°C (600°F)	5 seconds	L 280 mm x 100 mm (11 x 3.9")	stainless steel	K-Type

HI766PB

## Surface Probe

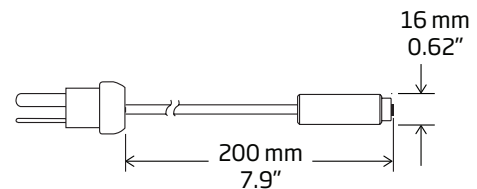

Specifications

Code	Max. Temperature	Response time (90% of final value)	Probe Dimensions	Probe Material	Connector Type
HI766PB	650°C (1200°F)	4 seconds	L 200 mm x dia 16 mm (7.9 x 0.6")	stainless steel	K-Type

HI766

# HI766 K-Type Thermocouple Wire Probes

General Specifications	
Accuracy	
±1.5°C (up to 375°C)	
±0.004 x T °C (above 375°C)	

HI766F

## High Temperature Wire Probe

with flexible sheath

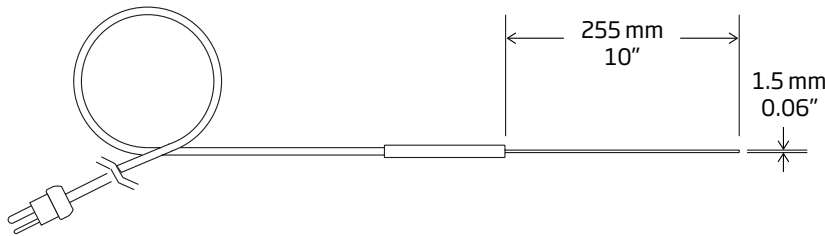

### Specifications

Code	Max. Temperature	Response time (90% of final value)	Probe Dimensions	Probe Material	Probe Handle	Cable Type	Cable Length	Connector Type
HI766F	1100°C (2000°F)	3 seconds	L 255 mm x dia 1.5 mm (10 x 0.06")	AISI 316 stainless steel	Aluminum	fiberglass with stainless steel overbraid / straight	1 m (3.3')	K-Type

HI766F1

## Wire Probe for Hard to Reach Places

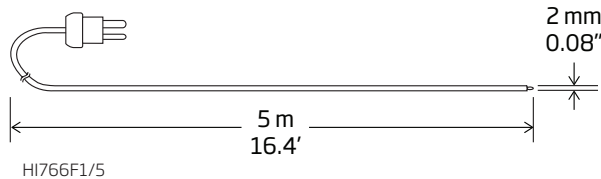
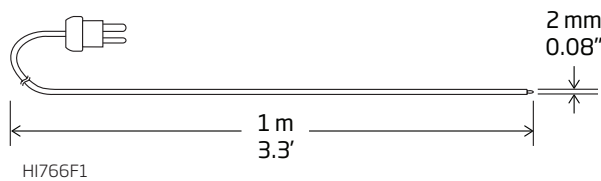

### Specifications

Code	Max. Temperature	Response time (90% of final value)	Probe Dimensions	Sensor	Cable Type	Cable Length	Connector Type
HI766F1	480°C (900°F)	4 seconds	dia 2 mm (0.08")	exposed wire	fiberglass/straight	1 m (3.3')	K-Type
HI766F1/5	480°C (900°F)	4 seconds	dia 2 mm (0.08")	exposed wire	fiberglass/straight	5 m (16.4')	K-Type



General Specifications

Accuracy

±1.5°C (up to 375°C)

±0.004 x T °C (above 375°C)

# HI766 K-Type Thermocouple Wire and Clamp Probes

HI766Z

## Wire Probe for Ovens

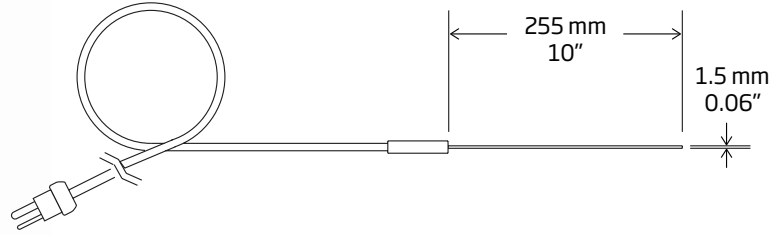
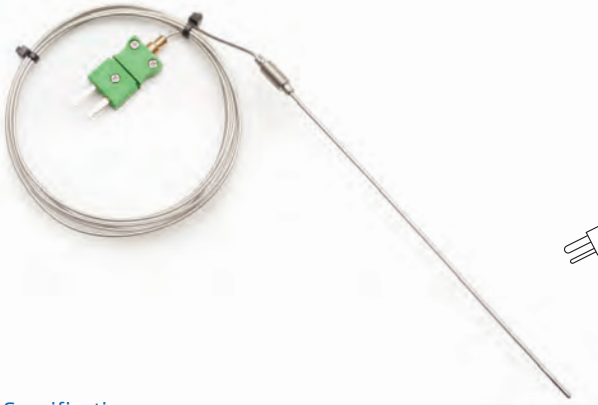

Specifications

Code	Max. Temperature	Response time (90% of final value)	Probe Dimensions	Probe Material	Cable Type	Cable Length	Connector Type
HI766Z	1100°C (2000°F)	4 seconds	L 255 mm x dia 1.5 mm (10 x 0.06")	stainless steel	stainless steel/straight	1.7 m (5.6')	K-Type
HI766Z/3	1100°C (2000°F)	4 seconds	L 255 mm x dia 1.5 mm (10 x 0.06")	stainless steel	stainless steel/straight	3 m (9.9')	K-Type
HI766Z/7	1100°C (2000°F)	4 seconds	L 255 mm x dia 1.5 mm (10 x 0.06")	stainless steel	stainless steel/straight	7 m (22.9')	K-Type

HI766TV1

## Clamp Probe for Pipes and Tubes

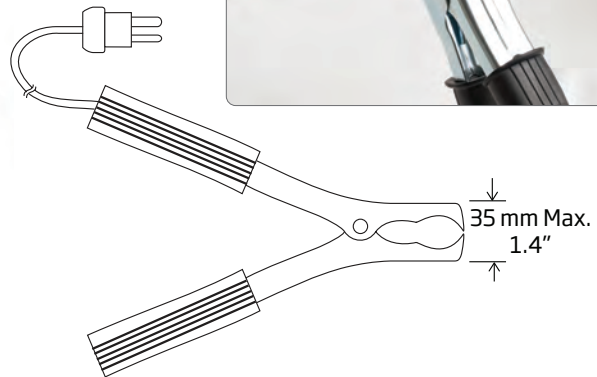

Specifications

Code	Max. Temperature	Response time (90% of final value)	Probe Dimensions	sensor	Probe Handle	Probe Handle Color	Cable Type	Cable Color/Length	Connector Type
HI766TV1	200°C (390°F)	4 seconds	Clamp Opening Diameter max 35 mm (1.4")	housed inside the clamp	ABS	Black	Polyurethane (PUR)/coiled	green / 1 m (3.3') cable	K-Type

HI93510 · HI93510N

# Thermistor Thermometers

- **HOLD**
  - HOLD Feature
- **BEPS**
  - Alerts the user of low battery power that could adversely affect readings
- **Battery indicator**
  - Battery level indicator at startup
- **Backlight**
  - Backlit display (N version)
- **Waterproof**
  - Compact, heavy-duty and waterproof

The HI93510 is a waterproof thermometer tailored for the lab and field. The LCD displays the highest and lowest readings in the cycle along with the current temperature. To freeze the reading for easy recording, simply press the HOLD button. Celsius or Fahrenheit range can be selected at the touch of a button.

The HI93510N offers all the features of the HI93510 plus a CAL button to allow the operator to calibrate the meter and probe in an ice bath at 0°C. This will assure the removal of the combined meter and probe interchange error. In addition to calibration capabilities, HI93510N has a user-activated backlit display.

A diverse assortment of HI762 probes and cable lengths are available. Probes can be ordered with different handle colors to prevent cross-contamination.

Advanced battery management features include a display of remaining battery power at startup, low battery warning and BEPS (Battery Error Prevention System), which alerts the user in the event that low battery power could adversely affect readings.



Specifications	HI93510	HI93510N
Range	-50.0 to 150.0°C; -58.0 to 302.0°F	
Resolution	0.1°C; 0.1°F (-58.0 to 230.0°F) and 0.2°F (outside)	
Accuracy	±0.4°C; ±0.8°F (for 1 year, excluding probe error)	
Probe	HI762BL air/liquid, stainless steel thermistor temperature probe with black handle and 1 m (3.3') cable (included)	
CAL Button	N/A	yes
Backlit LCD	N/A	yes
Battery Type / Life	1.5V AA (3) / approximately 2000 hours of continuous use (with backlight off); HI93510 only: auto-off selectable after 8 or 60 minutes of non-use (can be disabled)	
Environment	-10 to 50°C (14 to 122°F); RH max 100%	
Dimensions	150 x 80 x 36 mm (5.9 x 3.1 x 1.4")	
Weight	235 g (8.3 oz.)	
<b>Ordering Information</b>	<b>HI93510</b> and <b>HI93510N</b> are supplied with HI762BL temperature probe, batteries and instructions.	
<b>Probes</b>	<b>HI762L</b>	Liquid, stainless steel thermistor temperature probe with white handle and 1 m (3.3') cable
	<b>HI762A</b>	Air/gas, stainless steel thermistor temperature probe with white handle and 1 m (3.3') cable
<b>Accessories</b>	<b>HI710007</b>	blue shockproof rubber boot
	<b>HI710008</b>	orange shockproof rubber boot

General Specifications				
Sensor	Range	Accuracy	Interchange Error	Connector Type
NTC Thermistor	-50 to 150°C (-58 to 302°F)	±0.2°C (±0.4°F)	±0.2°C (±0.4°F)	RCA

HI762A

## Air and Gas Probe

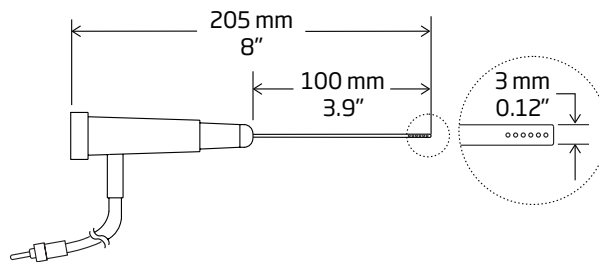

### Specifications

Code	Response time (90% of final value)	Probe Dimensions	Probe Material	Probe Handle	Probe Handle Color	Cable Type	Cable Color/Length
<b>HI762A</b>	5 seconds	L 100 mm x dia 3 mm (3.9 x 0.12")	AISI 316 stainless steel	Polypropylene (PP)	white	PVC/straight	white /1 m (3.3') Cable

HI762L, HI762BL

## Liquid Probe, General Purpose

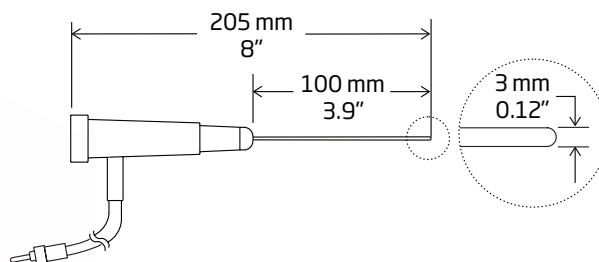

### Specifications

Code	Response time (90% of final value)	Probe Dimensions	Probe Material	Probe Handle	Probe Handle Color	Cable Type	Cable Color/Length
<b>HI762L</b>	5 seconds	L 100 mm x dia 3 mm (3.9 x 0.12")	AISI 316 stainless steel	Polypropylene (PP)	white	PVC/straight	white /1 m (3.3') Cable
<b>HI762L/2</b>	5 seconds	L 100 mm x dia 3 mm (3.9 x 0.12")	AISI 316 stainless steel	Polypropylene (PP)	white	PVC/straight	2 m (6.6') Cable
<b>HI762L/10</b>	5 seconds	L 100 mm x dia 3 mm (3.9 x 0.12")	AISI 316 stainless steel	Polypropylene (PP)	white	PVC/straight	black /10 m (32.8') Cable
<b>HI762BL</b>	6 seconds	L 100 mm x dia 3 mm (3.9 x 0.12")	AISI 316 stainless steel	Polypropylene (PP)	black	PVC/straight	1 m (3.3') Cable

## Calibration Test Keys for Thermistor Thermometers

For measurements that are always reliable, thermometers must be calibrated periodically. Hanna test keys offer a fast and simple way of checking the accuracy of your instruments. Connect the key to the probe input. If the reading on the display differs more than 0.4°C (0.8°F) from the key rated value, your thermometer should be recalibrated at our technical service center.



### Test Keys for Thermometers Using HI762 Probes

<b>HI762-18C</b>	Test key at -18°C	<b>HI762-004F</b>	Test key at -0.4°F
<b>HI762000C</b>	Test key at 0°C	<b>HI762032F</b>	Test key at 32°F
<b>HI762070C</b>	Test key at 70°C	<b>HI762158F</b>	Test key at 158°F

For periodic verification of your thermometer's calibration, it is recommended to check at least two points. Choose the test keys with the nominal values closest to the temperature usually measured.

HI762PW, HI762PBL

## Penetration Probe, General Purpose

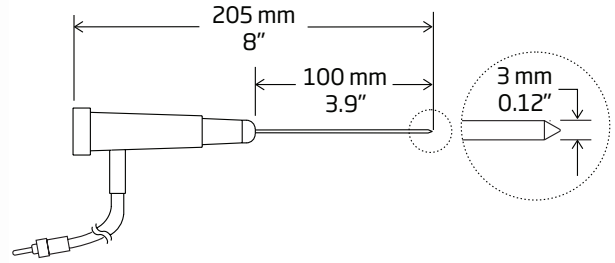

### Specifications

Code	Response time (90% of final value)	Probe Dimensions	Probe Material	Probe Handle	Probe Handle Color	Cable Type	Cable Length
HI762PBL	14 seconds	L 100 mm x dia 3 mm (3.9 x 0.12")	AISI 316 stainless steel	Polypropylene (PP)	blue	PVC/straight	1 m (3.3') Cable
HI762PW	6 seconds	L 100 mm x dia 3 mm (3.9 x 0.12")	AISI 316 stainless steel	Polypropylene (PP)	white	PVC/straight	1 m (3.3') Cable

HI762PWL

## Sharp tip Probe for Penetration of Semi-solid Samples.

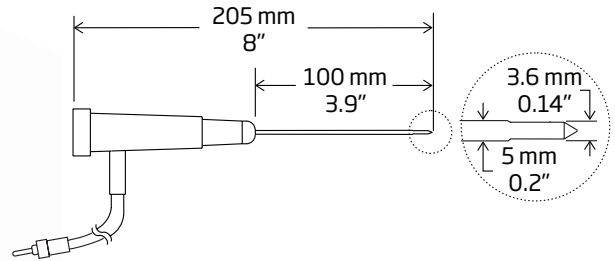

### Specifications

Code	Response time (90% of final value)	Probe Dimensions	Probe Material	Probe Handle	Probe Handle Color	Cable Type	Cable Length
HI762PWL	10 seconds	L 100 mm x dia 3.6 mm (3.9 x 0.15")	AISI 316 stainless steel	Polypropylene (PP)	white	PVC/straight	1 m (3.3') Cable

HI762W

## Wire Probe for Hard to Reach Places

Probe does not incorporate a handle.

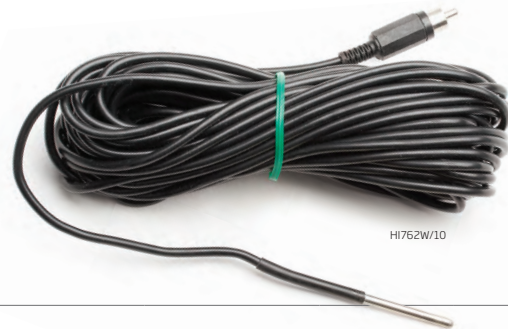
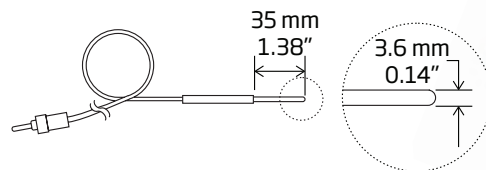

HI762W/10

### Specifications

Code	Response time (90% of final value)	Probe Dimensions	Probe Material	Probe Handle	Probe Handle Color	Cable Type	Cable Color/Length
HI762W	7 seconds	L 35 mm x dia 3.6 mm (1.38" x 0.14")	AISI 316 stainless steel	-	-	PVC/straight	1 m (3.3') Cable
HI762W/10	7 seconds	L 35 mm x dia 3.6 mm (1.38" x 0.14")	AISI 316 stainless steel	-	-	PVC/straight	black / 10 m (32.8') Cable

## Hanna Thermometers for the Food Sector

Operators in the food sector need an extensive range of products in order to guarantee the quality and safety of food supplied to the public while maintaining compliance with local and federal laws. In order to satisfy the need for quality, safety, and compliance, Hanna manufactures a vast range of products with the necessary accuracy and reliability to check the quality of food in all phases of preparation and distribution.

Many of Hanna's portable and pocket thermometer lines have become synonymous with temperature control in restaurants and catering facilities.

For the adverse measurement conditions found in food production areas, typically with high humidity and condensation problems, Hanna has manufactured a substantial array of waterproof meters.

To satisfy the requirements of HACCP, Hanna supplies a complete range of thermometers and pH meters to check goods from production to transport and from catering to storage. Documentation is a must in certain production cycles and important for HACCP programs. For this Hanna offers a range of logging meters. These are stand-alone meters that can measure and log the parameters without any supervision. Shock-resistant protective boots are available for many of our instruments.

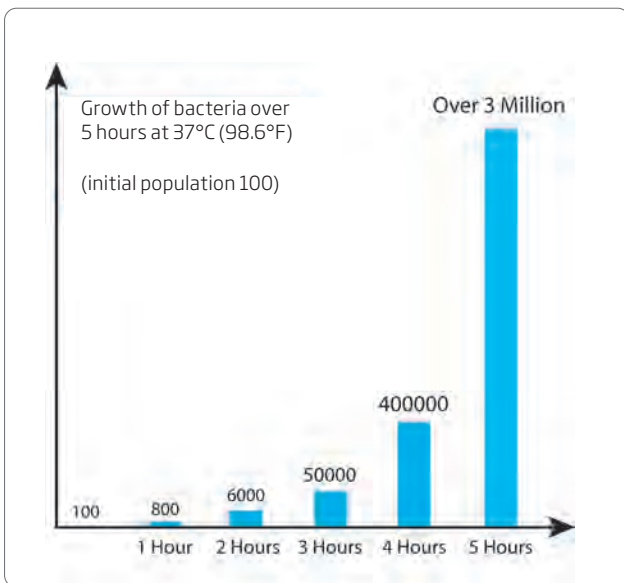

## Temperature

Temperature of food is constantly monitored to keep growth of pathogens and microorganisms under control. Temperature is important in production to ensure that the food is not spoiled and the quality is not compromised, therefore enhancing its value. Food needs to be kept at the correct temperature while stored, displayed, and on the move. If temperature is not properly controlled, bacteria can grow to dangerous levels in just a few hours.

The table below lists recommended temperatures for different products. It is vital to monitor and document the temperature to which food has been exposed.

Product	Temp.	Product	Temp.
Chunks of Meat	≤ 7°C	Smoked Fish	≤ 7°C
Minced Meat	≤ 4°C	Frozen Food	≤ -18°C
Innards	≤ 3°C	Milk	≤ 7°C
Frozen Chicken	≤ -12°C	Fruit and Vegetables	≤ 10°C
Deep-freeze Chicken	≤ -18°C	Eggs	≤ 8°C
Fresh Fish	≤ 2°C	Dried Fruit	≤ 25°C

Products and their recommended storage temperatures



Temperature plays an important role in the processing and preparation of edible products containing meat

## Meat

The temperature of meat at slaughterhouses is a vital quality control test and needs to be checked at various points of production. Fresh meat should be stored at about 2°C (35.6°F).

For deep-freeze meat in storage, it should have an internal temperature around -22°C (-7.6°F) with the surface temperature reaching -35°C (-31°F). In order to thaw the meat properly, the surrounding temperature should be 7°C (44.6°F).

## Ham and Sausages

The temperature of salted meat stored for several months is around 2°C (35.6°F). Afterwards, the product is rinsed and dried at around 25°C (77°F) prior to maturing at a preset temperature for a particular product. For sausages, the mixed ingredients are cooked at a certain temperature and then cooled at around 5 to 15°C (41 to 59°F).



### Beverages

The temperature of spring or deep well waters that are extracted for beverage production must be continuously monitored to ensure purity. During the production of soft drinks, syrup is pasteurized before being added, to prevent bacteriological problems. In order to prepare fruit juices, fruit pulp is heated to just below boiling point for a few seconds to reduce the presence of microorganisms. During both of these processes, accurate temperature monitoring is crucial.

Temperature control also plays a crucial role in beer production. For example, malt has to be heated to 75°C (167°F) during the mash process. Once the mash is cooled, the vessel is heated above boiling point to prepare the mash for a strainer; later the mash is heated to up to 120°C (248°F) for a few seconds to pasteurize it. The type of yeast then used for the fermentation process is also temperature dependent. By controlling the fermentation temperature, operators can determine the time needed for the product to fully develop. Temperature is also controlled during filtration, which is needed in order to remove particles and improve the taste and longevity of beer. In order to remove protein, beer is cooled down to almost 0°C (32°F). As with many other products on the market, beer is pasteurized at around 60°C (140°F) after it has been bottled to eliminate the presence of microorganisms.

### Milk and Dairy Products

Milk is checked for impurities and bacteria upon collection. During storage, the temperature of milk is normally kept below 5°C (41°F). In order to slow down cream formation, milk is homogenized at about 60°C (140°F).

The pasteurization of milk results in the reduction of microorganisms by 95% and is attained by raising the temperature to over 72°C (161.6°F). For UHT (ultra heat treated), milk is heated to 135/150°C (275/302°F) in a pressurized vessel for a few seconds. If the process is repeated for several minutes, all microorganisms, including spores, are destroyed and the sterilized milk will have a 12 month shelf life. For cheese, temperature needs to be adjusted before and during various processes, for example, when rennet is added.

Temperature in the maturation chamber also determines the period of maturation needed. Likewise, temperature is important in the production of butter. For example, skimmed milk is separated from cream at around 55°C (131°F) and the cream is then cooled to about 8°C (46.4°F). The temperature of incoming milk is raised to 45°C (113°F) before the addition of a culture for yogurt manufacturing. In order to denature the whey proteins, milk is raised to very high temperatures. The incubation temperature is maintained for a few hours prior to its cooling to about 10°C (50°F).





## Chocolate

Fermentation of cocoa beans is started by increasing the temperature to about 50°C (122°F). At different stages of chocolate manufacturing such as crystallization, accurate temperature measurement is a must. Once the chocolate is ready, the storage temperature should be monitored to ensure that it stays in the 15°C (59°F) range.



## Bread and Pasta

The temperature of stored grain in silos is controlled to ensure that premature fermentation does not occur. During pasta production, water at about 25°C (77°F) is added to wheat flour during fermentation of dough for bread-making, the temperature is kept at around 30°C (86°F). The oven temperature for baking should be around 260°C (500°F) and once baked, bread is cooled to room temperature. For semi-finished products that can be flash-baked, the dough has to be stored at very low temperatures.



## Sanitization of Machinery

The temperature of cleansing agents, together with their concentration, have a significant bearing on how effectively the machinery is sanitized. The temperature for fermentation vessels can range from room temperature to 40°C (104°F). For milk and yogurt, tanks may reach 70°C (158°F) and as high as 150°C (302°F) for steam sterilizers. In addition, regulatory bodies recommend a certain minimum temperature for cleaning agents to be effective; this can vary from 24°C (75.2°F) for iodine and ammonia and 49°C (120.2°F) for chlorine.



## Coffee

In order to invoke an aroma, coffee beans are heated up to 200°C (392°F). During roasting, the temperature is closely monitored. In order to provide a long shelf life, the finished product is frozen at -40°C (-40°F) prior to drying. To produce a good coffee, it is important to ensure that the temperature of coffee machines does not exceed 80°C (176°F).



HI935012

## Brewing Thermometer

with 1 m stainless steel probe

- FC762N2 1 m (3.3') stainless steel thermistor probe
- Durable IP67 waterproof casing
  - Designed to withstand the knocks, drops, and spills of real life, the new IP67 body ensures top performance in any environment. These meters are totally protected against dust and water intrusion from any direction.
- Probe Error Messages
  - The "NO PROBE" message is displayed on the meter when a probe is not attached or there is a break in the cable.
- CAL Check™
  - The calibration check (CAL Check) feature of the HI935012 is an internal diagnostic feature that checks for any drift in the electronics that occurs with all digital thermometers over time. When the meter is turned CAL Check looks to see if the internal calibration is within +/- 0.3 oC. If the drift is greater and error (err) message will be displayed. With CAL Check you can be confident that the meter is working properly.
- Large LCD
  - An enhanced LCD displays the measurement reading in oC or oF, stability indicator, error messages, and low battery indicator.
- Stability Indicator
  - An hourglass indicator is displayed on the LCD until a stable reading is obtained. Once a reading stabilizes, the indicator disappears and a reading can be recorded.
- Long Battery Life:
  - The thermometer has an exceptional battery life of approximately 4500 hours using three common AAA batteries. The battery percent level is displayed when powered on alerting the user to the remaining battery life.
- Automatic Shut-off
  - The meter can be set to automatically turn off after 8 minutes or 60 minutes to conserve battery life in the event that the meter is left on. The auto-off feature can also be disabled.

HI935012 includes HI710026 blue shockproof rubber boot to offer maximum impact protection.



The HI935012 is a waterproof portable thermistor thermometer made for the brewing professional that needs to measure the temperature in the center of a tank or vessel. This meter can be used at other critical points of the brewing process including the wort boil and fermentation. The HI935012 is supplied with the FC762N2 thermistor probe that is made of stainless steel and is 1 meter long. For a fast and accurate measurement the pre-calibrated semi-conductor sensor is located in the tip of the probe.

The HI935012, as a meter, can measure over a wide range of temperatures from -50.0 oC (-58.0 oF) up to 150 oC (302 oF) and offers a very high accuracy of +/-0.1 oC (+/-0.2 oF). The accuracy of the meter is assured with advanced diagnostic features including CAL-Check that checks for an abnormal drift of the internal electronics. Using a properly prepared ice bath, the meter and probe can be calibrated by the user. Additional features to have confidence in the measurements include a battery error prevention system (BEPS) that will not allow a reading to be taken when there is not sufficient battery power and probe diagnostics that alert the user when the probe is not connected.

Supplied with Instrument Quality Certificate- HI935012 with the FC762N2 are calibrated according to an ISO9001 calibration system using standards and reference instruments in which the accuracy is traceable the National Institute of Standards (NIST) in the USA, or to internationally acceptable physical standards.

\* The measurement range may be limited by probe type, and applies to the probe shaft.





### 1 M stainless steel probe

The supplied FC762N2 thermistor probe that is 1 M (39") long and 10 mm (0.39") in diameter. This extra long probe allows for the measurement of temperature in the middle of tank to make sure it is consistent throughout.



### Supplied with carrying case

The HI935102 is supplied with a soft carrying case that holds both the probe and the meter. There is a pouch inside for easy access to the meter.



Interchangeable with FC762 series thermistor probes



Specifications	HI935012
Range*	-20.0 to 120.0°C; -4.0 to 248.0°F
Resolution	0.1°C; 0.1°F
Meter Accuracy @ 23.0°C ±5°C	±0.1°C (-20.0 to 120.0°C); ±0.2°F (-4.0 to 248.0°F)
Probe Accuracy (FC762N2)	±0.3°C (-10.0 to 80.0°C); ±0.5°F (14 to 176°F); ±0.7°C / ±1.3°F remaining range
Probe	FC762N2 1 m (3.3') penetration probe with 1 m (3.3') white cable and white handle
Battery Type / Life	1.5V AAA (3) / approximately 4500 hours of continuous use; user-selectable auto-off after 8 or 60 minutes of non-use (can be disabled).
Environment	for product internal measurement: rated operating condition: -20 to 50°C (-4 to 122°F) limiting condition: -30 to 50°C (-22 to 122°F) storage and transportation condition: -40 to 70°C (-40 to 158°F)  relative humidity 100 %
Storage/transport temperature	-40 to 70°C (-40 to 158°F)
Dimensions	140 x 57 x 28 mm (5.5 x 2.2 x 1.1")
Mass	175 g (6.17 oz.)
Ordering Information	<b>HI935012</b> is supplied with FC762N2 temperature probe, protective rubber boot, 1.5V AAA batteries (3), quick reference guide, and instructions in a soft carrying case.

## Foodcare

HI93501

Thermistor  
Thermometer

- EN 13485 compliant
- FC762PW thermistor probe
- CAL Check™ feature
- Remaining battery life indication / low battery detection
- Auto-off
- IP65 Waterproof casing

Food service, food preparation, packaging, storage and transport of food require temperature to be monitored or controlled. Spot checking temperatures with Hanna food thermometers ensures daily work routines are carried out at the correct temperature.

HI93501 is a thermistor style thermometer that includes a stainless steel replaceable style penetration probe (FC762PW). It measures temperatures from -50 to 150°C (-58 to 302.0°F).

Standard features include waterproof casing (rated IP65) and stainless steel penetration probe designed for continuous contact with foodstuffs in accordance with regulation (EC) number 1935/2004. HI93501 also includes features such as CAL Check, low battery detection, auto-off capability, and long battery life.



Our optional HI710026 blue shockproof rubber boot offers maximum impact protection.



Interchangeable with FC762 series thermistor probes

## Specifications HI93501

Range*	-50.0 to 150.0°C; -58.0 to 302.0°F
Resolution	0.1°C; 0.1°F
Meter Accuracy @ 23.0°C ±5°C	±0.1°C (-50.0 to 150.0°C); ±0.2°F (-58.0 to 302.0°F)
Probe Accuracy (FC762PW)	±0.3°C (-10.0 to 80.0°C); ±0.5°F (14 to 176°F); ±0.7°C / ±1.3°F remaining range
Response time for 90% of final value	10 seconds
Probe	FC762PW general purpose penetration probe with 1 m (3.3') white cable and white handle
Battery Type / Life	1.5V AAA (3) / approximately 4500 hours of continuous use; user-selectable auto-off after 8 or 60 minutes of non-use (can be disabled).
Environment	for air measurement: Type E for product internal measurement: rated operating condition: -20 to 50°C (-4 to 122°F) limiting condition: -30 to 50°C (-22 to 122°F) storage and transportation condition: -40 to 70°C (-40 to 158°F) relative humidity 100 %
Storage/transport temperature	-40 to 70°C (-40 to 158°F)
Dimensions	140 x 57 x 28 mm (5.5 x 2.2 x 1.1")
Mass	175 g (6.17 oz.)
Certification	EN 13485:2001 suitability: storage and transport; climatic environment: E; accuracy class: 1;
Ordering Information	<b>HI93501</b> is supplied with FC762PW temperature probe, 1.5V AAA batteries (3), quick reference guide, and instructions.

\* The measurement range may be limited by probe type, and applies to the probe shaft.

# FC762 Foodcare Thermistor Probes

## General Specifications

Sensor	Range	Accuracy	Interchange Error	Connector Type
NTC Thermistor	-50 to 150°C (-58 to 302°F)	±0.3°C (-10 to 80°C)/ ±0.5°F (14 to 176°F); ±0.7°C / ±1.3°F (outside)	±0.2°C (±0.4°F)	RCA

### FC762PW

## Foodcare Penetration Probe, General Purpose

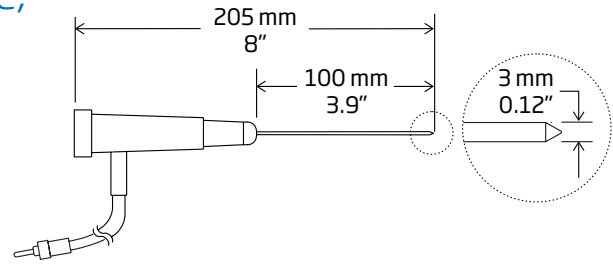

### Specifications

Code	Response time (90% of final value)	Probe Dimensions	Probe Material	Probe Handle	Probe Handle Color	Cable Type	Cable Length
<b>FC762PW</b>	6 seconds	L 100 mm x dia 3 mm (3.9 x 0.12")	AISI 316 stainless steel	Polypropylene (PP)	white	PVC/straight	white / 2 m (6.6') Cable

### FC762N2

## Foodcare Probe for Tanks, Vessels, and Vats

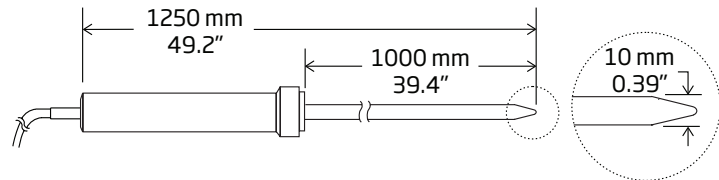

### Specifications

Code	Response time (90% of final value)	Probe Dimensions	Probe Material	Probe Handle	Probe Handle Color	Cable Type	Cable Color/Length
<b>FC762N2</b>		L 1000 mm x 10 mm (39" x 0.39")	Stainless steel	PVDF	white	PVC/straight	white / 2 m (6.6')

### FC762W1/2

## Wire probe designed for liquid immersion

Probe does not incorporate a handle.

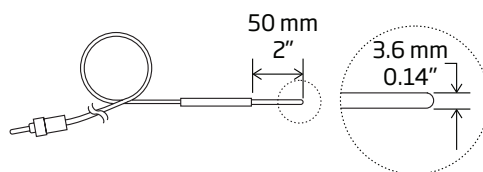

### Specifications

Code	Response time (90% of final value)	Probe Dimensions	Probe Material	Probe Handle	Probe Handle Color	Cable Type	Cable Color/Length
<b>FC762W1/2</b>	2min 45sec (98%FS)	L 50 mm x dia 3.6 mm (2" x 0.14")	AISI 316 stainless steel	-	-	PVC/straight	white / 2 m (6.6')

## Foodcare

HI935001

# K-Type Thermocouple Thermometer

- FC766PW K-type thermocouple probe
- CAL Check™ feature
- Remaining battery life indication/ low battery detection
- Auto-off
- IP65 Waterproof casing

Food service, food preparation, packaging, storage and transport of food require temperature to be monitored or controlled. Spot checking temperatures with Hanna food thermometers ensures daily work routines are carried out at the correct temperature.

HI935001 is a thermometer that includes a K-type thermocouple stainless steel replaceable style penetration probe (FC766PW). This thermometer offers a large range of temperature measurement; from -50 to 300°C (-58.0 to 572°F).

Standard features include waterproof casing (rated IP65) and stainless steel penetration probe designed for continuous contact with foodstuffs in accordance with regulation (EC) number 1935/2004. HI935001 also includes features such as CAL Check, low battery detection, auto-off capability, and long battery life.



Our optional HI710027 blue shockproof rubber boot offers maximum impact protection.



Interchangeable with FC766 series thermocouple probes



## Specifications HI935001

Range*	-50.0 to 199.9°C / 200 to 300°C; -58.0 to 399.9°F / 400 to 572°F
Resolution	0.1°C (-50.0 to 199.9°C) / 1°C (200 to 300°C); 0.1°F (-58.0 to 399.9°F) / 1°F (400 to 572°F)
Meter Accuracy @ 23.0°C ±5°C	±0.4°C (-50.0 to 300°C); ±0.7°F (-58.0 to 572°F)
Probe Accuracy (FC766PW)	±1.6°C (-50.0 to 300°C); ±2.9°F (-58.0 to 572°F)
Response time for 90% of final value	20 seconds
Probe	FC766PW penetration, K-type thermocouple probe with 1 m (3.3') white cable and white handle
Battery Type / Life	1.5V AAA (3) / approximately 3500 hours of continuous use; user-selectable auto-off after 8 or 60 minutes of non-use (can be disabled).
Environment	Rated operating condition: -20 to 50 °C (-4 to 122 °F) limiting condition: -30 to 50°C (-22 to 122°F) storage and transportation condition: -40 to 70 °C (-40 to 158°F) relative humidity 100 %
Storage/transport temperature	-40 to 70°C (-40 to 158°F)
Dimensions	140 x 57 x 28 mm (5.5 x 2.2 x 1.1")
Weight	178 g (6.27 oz.)
Ordering Information	<b>HI935001</b> is supplied with FC766PW temperature probe, 1.5V AAA batteries (3), quick reference guide, and instructions. <b>HI935001-03</b> includes the above without probe.

\* The measurement range may be limited by probe type, and applies to the probe shaft.

## Foodcare

HI935004

T-Type  
Thermocouple  
Thermometer

- EN 13485 compliant
- FC767PW T-type thermocouple probe
- CAL Check™ feature
- Remaining battery life indication / low battery detection
- Auto-off
- IP65 Waterproof casing

Food service, food preparation, packaging, storage and transport of food require temperature to be monitored or controlled. Spot checking temperatures with Hanna food thermometers ensures daily work routines are carried out at the correct temperature.

HI935004 is a thermometer that includes a T-type thermocouple stainless steel replaceable style penetration probe (FC767PW). This thermometer offers temperature measurement from -50 to 300°C (-58.0 to 572°F).

Standard features include waterproof casing (rated IP65) and stainless steel penetration probe designed for continuous contact with foodstuffs in accordance with regulation (EC) number 1935/2004. HI935004 also includes features such as CAL Check, low battery detection, auto-off capability, and long battery life.



Interchangeable  
with FC767 series  
thermocouple probes

Specifications	HI935004
Range*	-50.0 to 199.9°C / 200 to 300°C; -58.0 to 399.9°F / 400 to 572°F
Resolution	0.1°C (-50.0 to 199.9°C) / 1°C (200 to 300°C); 0.1°F (-58.0 to 399.9°F) / 1°F (400 to 572°F)
Meter Accuracy @ 23.0°C ±5°C	±0.4°C (-50.0 to 300°C); ±0.7°F (-58.0 to 572°F)
Probe Accuracy (FC767PW)	±0.6°C (-50 to 100.0°C); ±1.6°C (100.0 to 300°C); ±1.1°F (-58 to 212°F); ±2.9°F (212 to 572°F)
Response time for 90% of final value	20 seconds
Probe	FC767PW penetration, T-type thermocouple probe with 1 m (3.3') white cable and white handle
Battery Type / Life	1.5V AAA (3) / approximately 3500 hours of continuous use; user-selectable auto-off after 8 or 60 minutes of non-use (can be disabled).
Environment	for air measurement: Type E for product internal measurement: rated operating condition: -20 to 50°C (-4 to 122°F) limiting condition: -30 to 50°C (-22 to 122°F) storage and transportation condition: -40 to 70°C (-40 to 158°F) relative humidity 100 %
Storage/transport temperature	-40 to 70°C (-40 to 158°F)
Dimensions	140 x 57 x 28 mm (5.5 x 2.2 x 1.1")
Mass	178 g (6.27 oz.)
Certification	EN 13485:2001 suitability: storage and transport; climatic environment: E; accuracy class: 1;
Ordering Information	<b>HI935004</b> is supplied with FC767PW temperature probe, 1.5V AAA batteries (3), quick reference guide, and instructions.

\*The measurement range may be limited by probe type, and applies to the probe shaft.



Our optional  
HI710027 blue  
shockproof  
rubber boot offers  
maximum impact  
protection.

HI9350011

## K-Type Thermocouple Thermometer

with ultra-fast probe

- FC766C1 ultra-fast K-type thermocouple probe
- CAL Check™ feature
- Remaining battery life indication/ low battery detection
- Auto-off
- IP65 Waterproof casing

The HI9350011 is a waterproof portable K-Type thermocouple thermometer made for the food professional that is required to monitor temperature as part of a hazardous analysis of critical control points (HACCP) plan including in food service, production, packaging, transportation, restaurants or catering. The HI9350011, as a meter, can measure over a wide range of temperatures from -50.0°C (-58.0°F) up to 300°C (573°F) and offers a very high accuracy of  $\pm 0.4^\circ\text{C}$  ( $\pm 0.7^\circ\text{F}$ ). The accuracy of the meter is assured with advanced diagnostic features including CAL-Check that checks for abnormal drift of the internal electronics, battery error prevention system (BEPS) that will not allow a reading to be taken when there is not sufficient battery power and probe diagnostics that alert the user when the probe is not connected or has been damaged.

HI9350011 Foodcare thermometer is supplied with the replaceable FC766C1 Ultra-Fast K-Type thermocouple probe that will reach 90% of the final reading within 4 seconds. The tip of FC766C1 is just 1.6 mm (0.06") in diameter allowing for easy penetrations into solids and semi-solids. The AISI 316 stainless steel body is 95 mm (3.7") long and is safe for food contact in compliance with Regulation (EC) 1935/2004.



Our optional HI710027 blue shockproof rubber boot offers maximum impact protection.



Interchangeable with FC766 series thermocouple probes

### Specifications HI9350011

Range*	-50.0 to 199.9°C / 200 to 300°C; -58.0 to 399.9°F / 400 to 572°F
Resolution	0.1°C (-50.0 to 199.9°C) / 1°C (200 to 300°C); 0.1°F (-58.0 to 399.9°F) / 1°F (400 to 572°F)
Meter Accuracy @ 23.0°C $\pm 5^\circ\text{C}$	$\pm 0.4^\circ\text{C}$ (-50.0 to 300°C); $\pm 0.7^\circ\text{F}$ (-58.0 to 572°F)
Probe Accuracy (FC766C1)	$\pm 1.6^\circ\text{C}$ (-50.0 to 300°C); $\pm 2.9^\circ\text{F}$ (-58.0 to 572°F)
Response time for 90% of final value	4 seconds
Probe	FC766C1 penetration, K-type thermocouple probe with 1m (3.3') white cable and white handle
Battery Type / Life	1.5V AAA (3) / approximately 3500 hours of continuous use; user-selectable auto-off after 8 or 60 minutes of non-use (can be disabled).
Environment	Rated operating condition: -20 to 50 °C (-4 to 122 °F)
	limiting condition: -30 to 50°C (-22 to 122°F)
	storage and transportation condition: -40 to 70 °C (-40 to 158°F)
Storage/transport temperature	-40 to 70°C (-40 to 158°F)
Dimensions	140 x 57 x 28 mm (5.5 x 2.2 x 1.1")
Weight	178 g (6.27 oz.)
<b>Ordering Information</b>	<b>HI9350011</b> is supplied with FC766C1 temperature probe, 1.5V AAA batteries (3), quick reference guide, and instructions.

\*The measurement range may be limited by probe type, and applies to the probe shaft.

## Foodcare

HI9350041

# T-Type Thermocouple Thermometer

with ultra-fast probe

- FC767C1 ultra-fast T-type thermocouple probe
- CAL Check™ feature
- Remaining battery life indication / low battery detection
- Stability Indicator
  - An hourglass indicator is displayed on the LCD until a stable reading is obtained.
- Auto-off
- IP65 Waterproof casing

The HI9350041 is a waterproof portable T-Type thermocouple thermometer made for the food professional that is required to monitor temperature as part of a hazardous analysis of critical control points (HACCP) plan including in food service, production, packaging, transportation, restaurants or catering. The HI9350041, as a meter, can measure over a wide range of temperatures from -50.0°C (-58.0°F) up to 300°C (572°F) and offers a very high accuracy of  $\pm 0.4^{\circ}\text{C}$  ( $\pm 0.7^{\circ}\text{F}$ ). The accuracy of the meter is assured with advanced diagnostic features including CAL Check that checks for abnormal drift of the internal electronics, battery error prevention system (BEPS) that will not allow a reading to be taken when there is not sufficient battery power and probe diagnostics that alert the user when the probe is not connected or has been damaged.

HI9350041 Foodcare thermometer is supplied with the replaceable FC767C1 Ultra-Fast T-Type thermocouple probe that will reach 90% of the final reading within 4 seconds. The tip of FC767C1 is just 1.6 mm (0.06") in diameter allowing for easy penetrations into solids and semi-solids. The AISI 316 stainless steel body is 95 mm (3.7") long and is safe for food contact in compliance with Regulation (EC) 1935/2004.

The HI9350041 with the HI767C1 is certified according to EN13485:2001 standard that has strict requirements for accuracy, response time, operating and storage conditions as applied to the measurement of product temperature which are intended for use in transportation, storage and distribution facilities of refrigerated, frozen or deep-frozen food and ice cream.



Our optional HI710027 blue shockproof rubber boot offers maximum impact protection.

Interchangeable with FC767 series thermocouple probes

Specifications	HI9350041
Range*	-50.0 to 199.9°C / 200 to 300°C; -58.0 to 399.9°F / 400 to 572°F
Resolution	0.1°C (-50.0 to 199.9°C) / 1°C (200 to 300°C); 0.1°F (-58.0 to 399.9°F) / 1°F (400 to 572°F)
Meter Accuracy @ 23.0°C $\pm 5^{\circ}\text{C}$	$\pm 0.4^{\circ}\text{C}$ (-50.0 to 300°C); $\pm 0.7^{\circ}\text{F}$ (-58.0 to 572°F)
Probe Accuracy (FC767C1)	$\pm 0.6^{\circ}\text{C}$ (-50 to 100.0°C); $\pm 1.6^{\circ}\text{C}$ (100.0 to 300°C); $\pm 1.1^{\circ}\text{F}$ (-58 to 212°F); $\pm 2.9^{\circ}\text{F}$ (212 to 572°F)
Response time for 90% of final value	4 seconds
Probe	FC767C1 penetration, T-type thermocouple probe with 1 m (3.3') white cable and white handle
Battery Type / Life	1.5V AAA (3) / approximately 3500 hours of continuous use; user-selectable auto-off after 8 or 60 minutes of non-use (can be disabled).
Environment	for air measurement: Type E for product internal measurement: rated operating condition: -20 to 50°C (-4 to 122°F) limiting condition: -30 to 50°C (-22 to 122°F) storage and transportation condition: -40 to 70°C (-40 to 158°F) relative humidity 100 %
Storage/transport temperature	-40 to 70°C (-40 to 158°F)
Dimensions	140 x 57 x 28 mm (5.5 x 2.2 x 1.1")
Mass	178 g (6.27 oz.)
Ordering Information	<b>HI9350041</b> is supplied with FC767C1 temperature probe, 1.5V AAA batteries (3), quick reference guide, and instructions.

\*The measurement range may be limited by probe type, and applies to the probe shaft.

## Foodcare

HI935007

# K-Type Thermocouple Thermometer

- Fixed K-type thermocouple probe
- CAL Check™ feature
- Remaining battery life indication/ low battery detection
- Auto-off
- IP65 Waterproof casing

Food service, food preparation, packaging, storage and transport of food require temperature to be monitored or controlled. Spot checking temperatures with Hanna food thermometers ensures daily work routines are carried out at the correct temperature.

HI935007 is a thermometer that incorporates a fixed K-type thermocouple stainless steel penetration probe to provide the greatest accuracy. This thermometer offers a large range of temperature measurement; from -50 to 300°C (-58.0 to 572°F).

Standard features include waterproof casing (rated IP65) and stainless steel penetration probe designed for continuous contact with foodstuffs in accordance with regulation (EC) number 1935/2004. HI935007 also includes features such as CAL Check, low battery detection, auto-off capability, and long battery life.



Fixed thermocouple probe



Our optional HI710026 blue shockproof rubber boot offers maximum impact protection.

Specifications	HI935007
Range*	-50.0 to 199.9°C / 200 to 300°C; -58.0 to 399.9°F / 400 to 572°F
Resolution	0.1°C (-50.0 to 199.9°C) / 1°C (200 to 300°C); 0.1°F (-58.0 to 399.9°F) / 1°F (400 to 572°F)
System Accuracy (Meter @ 23.0°C ±5°C)	±1°C (-50.0 to 100.0°C) / ±2 °C (100.0 to 300°C); ±1.8°F (-58.0 to 212°F) / ±3.6 °F (212 to 572°F)
Probe	fixed penetration, K-type thermocouple probe with 1 m (3.3') white cable and white handle
Response time for 90% of final value	20 seconds
Battery Type / Life	1.5V AAA (3) / approximately 3500 hours of continuous use; user-selectable auto-off after 8 or 60 minutes of non-use (can be disabled).
Environment	Rated operating condition: -20 to 50 °C (-4 to 122 °F)
	limiting condition: -30 to 50°C (-22 to 122°F)
	storage and transportation condition: -40 to 70°C (-40 to 158°F)
Storage/transport temperature	-40 to 70°C (-40 to 158°F)
Dimensions	140 x 57 x 28 mm (5.5 x 2.2 x 1.1")
Mass	178 g (6.27 oz.)
Ordering Information	<b>HI935007</b> is supplied with fixed temperature probe, 1.5V AAA batteries (3), quick reference guide, and instructions.

\* The measurement range applies to the probe shaft.



General Specifications

Accuracy

±1.5°C (up to 375°C)  
±0.004 x T °C (above 375°C)

# FC766 Foodcare K-Type Thermocouple Probes

FC766PW

## Foodcare Penetration Probe

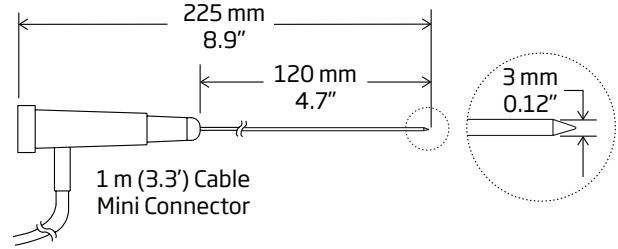

Specifications

Code	Max. Temperature	Response time (90% of final value)	Probe Dimensions	Probe Material	Probe Handle	Probe Handle Color	Cable Type	Cable Color/ Length	Connector Type
<b>FC766PW</b>	300°C (570°F)	13 seconds	L 120 mm x dia 3 mm (4.7 x 0.12")	stainless steel	Polypropylene (PP)	white	Polyurethane (PUR)/coiled	white / 1 m (3.3')	K-Type

FC766C1

## Foodcare Ultra-fast Probe

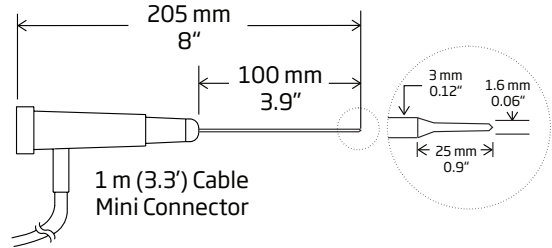

Specifications

Code	Max. Temperature	Accuracy	Response time (90% of final value)	Probe Dimensions	Probe Material	Probe Handle	Probe Handle Color	Cable Type	Cable Color/ Length	Connector Type
<b>FC766C1</b>	300°C (570°F)	±1.6°C (-50 to 300°C) ±2.9°F (-58 to 573°F)	3 seconds	L 100 mm x dia 3 mm (3.9 x 0.12")	AISI 316 stainless steel	Polypropylene (PP)	white	Polyurethane (PUR)/coiled	white / 1 m (3.3')	K-Type

FC766TS Series

## Foodcare Penetration Probe for Semi-Solid Samples

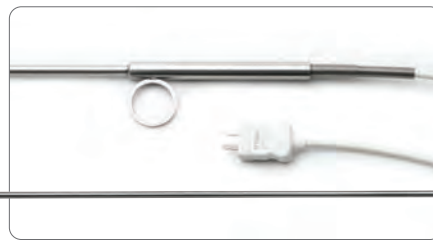

Specifications

Code	Range	Response time (90% of final value)	Probe Dimensions	Probe Material	Probe Handle	Probe Handle Color	Cable Type	Cable Color/ Length	Connector Type
<b>FC766TS2</b>	-40 to 400°C (-40 to 752°F)	14 seconds	L 200 mm x dia 6 mm (.66' x 0.24")	stainless steel	stainless steel	silver	coiled cable with PVC insulation	white/ 1 m (3.3')	K-Type
<b>FC766TS5</b>	-40 to 400°C (-40 to 752°F)	14 seconds	L 500 mm x dia 6 mm (1.64' x 0.24")	stainless steel	stainless steel	silver	coiled cable with PVC insulation	white/ 1 m (3.3')	K-Type
<b>FC766TS7</b>	-40 to 400°C (-40 to 752°F)	14 seconds	L 700 mm x dia 6 mm (2.29' x 0.24")	stainless steel	stainless steel	silver	coiled cable with PVC insulation	white/ 1 m (3.3')	K-Type
<b>FC766TS10</b>	-40 to 400°C (-40 to 752°F)	14 seconds	L 1000 mm x dia 6 mm (3.28' x 0.24")	stainless steel	stainless steel	silver	coiled cable with PVC insulation	white/ 1 m (3.3')	K-Type
<b>FC766TS14</b>	-40 to 400°C (-40 to 752°F)	14 seconds	L 1400 mm x dia 6 mm (4.59' x 0.24")	stainless steel	stainless steel	silver	coiled cable with PVC insulation	white/ 1 m (3.3')	K-Type

FC766

# FC766 Foodcare K-Type Thermocouple Probes without Handle

## General Specifications

### Accuracy

±1.5°C (up to 375°C)  
±0.004 x T °C (above 375°C)

The FC766P series are K-type thermocouple temperature probes to be used with thermocouple thermometers. These probes are ideal for measuring samples at very high temperatures, such as in industrial applications. Probes in this section are recommended to be used with the FC766HD probe handle and/or FC766EX extension cable. All probes are made of stainless steel for long life and easy cleaning.



FC766HD

FC766HD

## Foodcare Probe Handle

A rugged, PVC handle with a 1 meter (3.3') cable. It is provided with a female connector, which allows the connection of any FC766Px probe.

### Specifications

Code	Probe Handle	Probe Handle Color	Cable Type	Cable Color / Length	Connector Type
<b>FC766HD</b>	Polypropylene (PP)	white	Polyurethane (PUR)/coiled	white / 1 m (3.3')	K-Type



FC766EX

FC766EX

## Foodcare Extension Cable

A coiled cable which extends the probe cable by 1 m (3.3') , with two connectors at the two ends (1 male and 1 female).

### Specifications

Code	Cable Type	Cable Color / Length	Connector Type
<b>FC766EX</b>	Polyurethane (PUR)/coiled	white / 1 m (3.3')	K-Type

FC766PC1

## Foodcare Stainless Steel Probe with Exposed Sensor

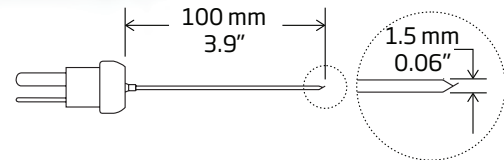

### Specifications

Code	Range	Probe Dimensions	Probe Material	Sensor	Connector Type
<b>FC766PC1</b>	-40 to 300°C	L100mm x dia 1.5mm	stainless steel	exposed wires	K-Type

General Specifications

Accuracy

±1.5°C (up to 375°C)  
±0.004 x T °C (above 375°C)

# FC766 Foodcare K-Type Thermocouple Probes for Specific Applications

FC766F

## Foodcare Wire Probes for Hard to Reach Places

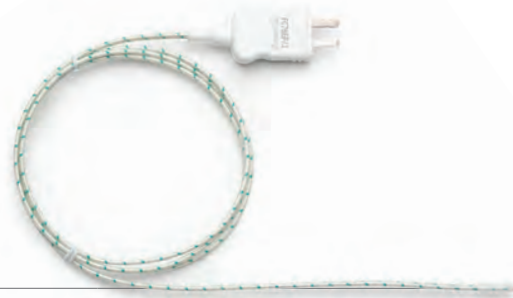
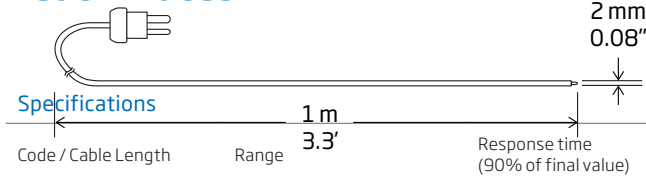

Code / Cable Length	Range	Response time (90% of final value)	Probe Dimensions	Sensor	Cable Type	Connector Type
<b>FC766F/1</b> / 1 m (3.3')	-40 to 400°C (-40 to 752°F)	14 seconds	dia 2 mm (0.08")	exposed wire	Fiberglass insulated/straight	K-Type
<b>FC766F/3</b> / 3 m (9.9')	-40 to 400°C (-40 to 752°F)	14 seconds	dia 2 mm (0.08")	exposed wire	Fiberglass insulated/straight	K-Type
<b>FC766F/5</b> / 5 m (16.4')	-40 to 400°C (-40 to 752°F)	14 seconds	dia 2 mm (0.08")	exposed wire	Fiberglass insulated/straight	K-Type
<b>FC766F/10</b> / 10 m (33')	-40 to 400°C (-40 to 752°F)	14 seconds	dia 2 mm (0.08")	exposed wire	Fiberglass insulated/straight	K-Type
<b>FC766F/20</b> / 20 m (66')	-40 to 400°C (-40 to 752°F)	14 seconds	dia 2 mm (0.08")	exposed wire	Fiberglass insulated/straight	K-Type

FC766Y

## Foodcare Wire Probes for Ovens and Furnaces

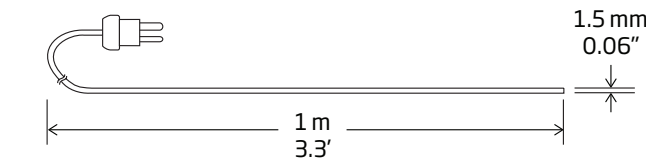

Code / Cable Length	Range	Response time (98% of final value)	Probe Dimensions	Probe Material	Cable Type	Connector Type
<b>FC766Y/1</b> / 1 m (3.3')	-40 to 1000°C (-40 to 1832°F)	15 seconds	L 1000 mm x dia 1.5 mm (39" x 0.06")	stainless steel	Stainless Steel/straight	K-Type
<b>FC766Y/2</b> / 2 m (6.6')	-40 to 1000°C (-40 to 1832°F)	15 seconds	L 1000 mm x dia 1.5 mm (39" x 0.06")	stainless steel	Stainless Steel/straight	K-Type
<b>FC766Y/3</b> / 3 m (9.9')	-40 to 1000°C (-40 to 1832°F)	15 seconds	L 1000 mm x dia 1.5 mm (39" x 0.06")	stainless steel	Stainless Steel/straight	K-Type
<b>FC766Y/5</b> / 5 m (16.4')	-40 to 1000°C (-40 to 1832°F)	15 seconds	L 1000 mm x dia 1.5 mm (39" x 0.06")	stainless steel	Stainless Steel/straight	K-Type
<b>FC766Y/8</b> / 8 m (26')	-40 to 1000°C (-40 to 1832°F)	15 seconds	L 1000 mm x dia 1.5 mm (39" x 0.06")	stainless steel	Stainless Steel/straight	K-Type
<b>FC766Y/10</b> / 10 m (33')	-40 to 1000°C (-40 to 1832°F)	15 seconds	L 1000 mm x dia 1.5 mm (39" x 0.06")	stainless steel	Stainless Steel/straight	K-Type

FC766W1

## Foodcare Wire Probes with Insulated Cable

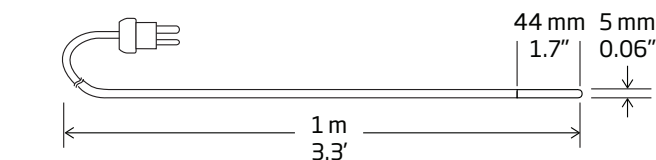

Code / Cable Length	Range	Response time (98% of final value)	Probe Dimensions	Probe Material	Cable Type	Cable Color	Connector Type
<b>FC766W1/1</b> / 1 m (3.3')	-40 to 120°C	2min 30 sec	L 44 mm x dia 5mm (1.7" x 0.2")	stainless steel	Polyurethane (PUR)/straight	white	K-Type
<b>FC766W1/3</b> / 3 m (9.9')	-40 to 120°C	2min 30 sec	L 44 mm x dia 5mm (1.7" x 0.2")	stainless steel	Polyurethane (PUR)/straight	white	K-Type
<b>FC766W1/5</b> / 5 m (16.4')	-40 to 120°C	2min 30 sec	L 44 mm x dia 5mm (1.7" x 0.2")	stainless steel	Polyurethane (PUR)/straight	white	K-Type
<b>FC766W1/10</b> / 10 m (33')	-40 to 120°C	2min 30 sec	L 44 mm x dia 5mm (1.7" x 0.2")	stainless steel	Polyurethane (PUR)/straight	white	K-Type

FC766

# FC766 Foodcare K-Type Thermocouple Probes for Specific Applications

## General Specifications

### Accuracy

±1.5°C (up to 375°C)  
±0.004 x T °C (above 375°C)

FC766T

## Foodcare Wire Probes for Hard to Reach Places

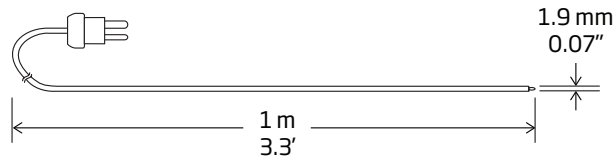

### Specifications

Code / Cable Length	Range	Response time (90% of final value)	Probe Dimensions	Sensor	Cable Type	Connector Type
<b>FC766T/1</b> / 1 m (3.3')	-40 to 250°C (-40 to 482°F)	-	dia 1.9 mm (0.07")	exposed wire	PTFE insulated/straight	K-Type
<b>FC766T/3</b> / 3 m (9.9')	-40 to 250°C (-40 to 482°F)	-	dia 1.9 mm (0.07")	exposed wire	PTFE insulated/straight	K-Type
<b>FC766T/5</b> / 5 m (16.4')	-40 to 250°C (-40 to 482°F)	-	dia 1.9 mm (0.07")	exposed wire	PTFE insulated/straight	K-Type
<b>FC766T/7</b> / 7 m (23')	-40 to 250°C (-40 to 482°F)	-	dia 1.9 mm (0.07")	exposed wire	PTFE insulated/straight	K-Type
<b>FC766T/10</b> / 10 m (33')	-40 to 250°C (-40 to 482°F)	-	dia 1.9 mm (0.07")	exposed wire	PTFE insulated/straight	K-Type

FC766TZ

## Foodcare Wire Stainless Steel Probes for Sous Vide

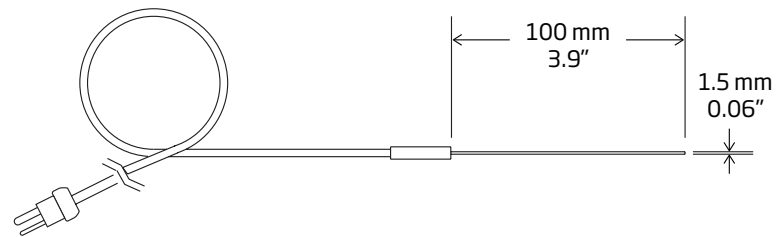

### Specifications

Code	Range	Probe Dimensions	Sensor	Cable Type	Cable Length	Connector Type
<b>FC766TZ/30</b>	-40 to 200°C	L 30 mm x dia 1 mm (1.18" x 0.04")	stainless steel	PTFE insulated/straight	1 m (3.3')	K-Type
<b>FC766TZ/60</b>	-40 to 200°C	L 60 mm x dia 1 mm (2.36" x 0.04")	stainless steel	PTFE insulated/straight	1 m (3.3')	K-Type
<b>FC766TZ/120</b>	-40 to 200°C	L 120 mm x dia 1 mm (4.7" x 0.04")	stainless steel	PTFE insulated/straight	1 m (3.3')	K-Type
<b>FC766TZ-0</b>	Spare tape for Sous Vides temperature probe (1 mt)					

FC766TZ2/1

## Foodcare Wire Stainless Steel Penetration Probe



### Specifications

Code	Range	Probe Dimensions	Sensor	Cable Type	Cable Length	Connector Type
<b>FC766TZ2/1</b>	-40 to 600°C	L 185 mm x dia 1.8 mm (7.2" x 0.07")	stainless steel	straight	1 m (3.3')	K-Type

# FC767 Foodcare T-Type Thermocouple Probes

FC767C1

## Foodcare Ultra-fast Probe

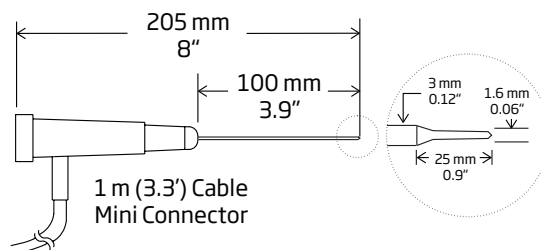

### Specifications

Code	Max. Temperature	Accuracy	Response time (90% of final value)	Probe Dimensions	Probe Material	Probe Handle	Probe Handle Color	Cable Type	Cable Color/ Length	Connector Type
<b>FC767C1</b>			4 seconds	L 100 mm x dia 3 mm (3.9" x 0.12")	AISI 316 stainless steel	Polypropylene (PP)	white	Polyurethane (PUR)/coiled	white / 1 m (3.3')	T-Type

FC767PW

## Foodcare Penetration Probe

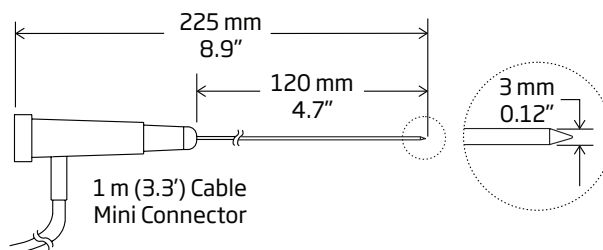

### Specifications

Code	Range	Accuracy	Response time (90% of final value)	Probe Dimensions	Probe Material	Probe Handle	Probe Handle Color	Cable Type	Cable Color/ Length	Connector Type
<b>FC767PW</b>	300°C (570°F)	±0.6°C (-50 to 100.0°C), ±1.6°C (100.0 to 300°C) /±1.1°F (-58 to 212 °F); ±2.9°F (212 to 573 °F)	15 seconds	L 120 mm x dia 3 mm (4.7" x 0.12")	stainless steel	Polypropylene (PP)	white	Polyurethane (PUR)/coiled	white / 1 m (3.3')	T-Type

# FC767 Foodcare T-Type Thermocouple Probes

## FC767TS Series

### Foodcare Penetration Probe for Semi-Solid Samples



#### Specifications

Code	Range	Response time (90% of final value)	Probe Dimensions	Probe Material	Probe Handle	Probe Handle Color	Cable Type	Cable Color/Length	Connector Type
HI767TS2	-40 to 250°C (-40 to 482°F)	12 seconds	L 200 mm x dia 6 mm (.66' x 0.24")	stainless steel	stainless steel	silver	coiled cable with PVC insulation	white/ 1 m (3.3')	T-Type
HI767TS5	-40 to 250°C (-40 to 482°F)	12 seconds	L 500 mm x dia 6 mm (1.64' x 0.24")	stainless steel	stainless steel	silver	coiled cable with PVC insulation	white/ 1 m (3.3')	T-Type
HI767TS7	-40 to 250°C (-40 to 482°F)	12 seconds	L 700 mm x dia 6 mm (2.29' x 0.24")	stainless steel	stainless steel	silver	coiled cable with PVC insulation	white/ 1 m (3.3')	T-Type
HI767TS10	-40 to 250°C (-40 to 482°F)	12 seconds	L 1000 mm x dia 6 mm (3.28' x 0.24")	stainless steel	stainless steel	silver	coiled cable with PVC insulation	white/ 1 m (3.3')	T-Type
HI767TS14	-40 to 250°C (-40 to 482°F)	12 seconds	L 1400 mm x dia 6 mm (4.59' x 0.24")	stainless steel	stainless steel	silver	coiled cable with PVC insulation	white/ 1 m (3.3')	T-Type

## FC767W1/1

### Foodcare Wire Probe with Insulated Cable

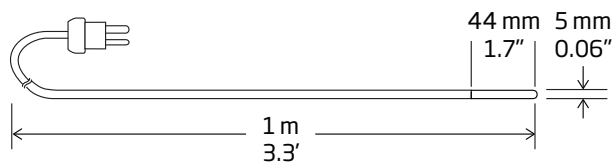

#### Specifications

Code	Range	Response time (98% of final value)	Probe Dimensions	Probe Material	Cable Type	Cable Color / Length	Connector Type
FC767W1/1	-40 to 120°C	2min 10 sec	L 44 mm x dia 5mm (1.7" x 0.2")	stainless steel	Polyurethane (PUR)/straight	white/1 m (3.3')	T-Type

# FC767 Foodcare T-Type Thermocouple Probes

FC767Y/1

## Foodcare Wire Probe for Ovens and Furnaces



### Specifications

Code	Range	Response time (98% of final value)	Probe Dimensions	Probe Material	Cable Type	Cable Length	Connector Type
<b>FC767Y/1</b>	-40 to 1000°C (-40 to 1832°F)	15 seconds	L 1000 mm x dia 1.5 mm (39" x 0.06")	stainless steel	Stainless Steel/straight	1 m (3.3')	T-Type

FC767F/1

## Foodcare Wire Probe for Hard to Reach Places



### Specifications

Code	Range	Response time (90% of final value)	Probe Dimensions	Sensor	Cable Type	Cable Length	Connector Type
<b>FC767F/1</b>	-40 to 400°C (-40 to 752°F)	14 seconds	dia 2 mm (0.08")	exposed wire	Fiberglass insulated/straight	1 m (3.3')	T-Type

HI148 Series

# Waterproof Thermologgers

- IP67 waterproof casing
- Wall cradle included for versatile installation and easy thermologger removal
- One or two channels, with internal and/or external sensor
- 16,000 samples (for 1-channel models) or 8000 samples/channels (for 2-channels models)
- Programmable high and low alarms
- Programmable logging interval from 1 second to 24 hours for 1-channel models, from 2 seconds to 24 hours for 2-channel models
- Storing of temperature at logging interval, or min or max temperature between logging intervals
- Logging delay start from 1 second to 199 hours using the HI92148 PC application or the Log start button
- Non-volatile storage of logging parameters and data in EEPROM
- BEPS (Battery Error Prevention System)
- Security password and lot serial number
- USB Type-C connector
- All HI148 thermologgers are factory calibrated.

The HI148 series of thermologgers are ideal for monitoring temperature in applications such as food processing, transportation, museums, and horticulture.

The thermologgers feature extensive memory capacity: 16,000 samples for 1-channel models and 8000 samples/channel for 2-channel models.

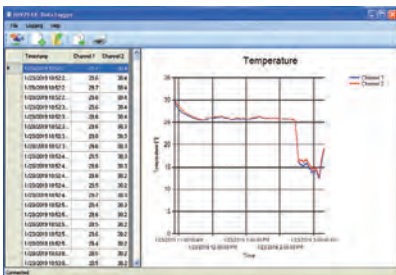

The HI92148 application software (required) supports communication between the logger and a PC running Windows® OS through a USB-C cable. Using the application, data acquisition parameters are user selectable and logged data can be downloaded and stored via USB cable.



USB connection

**HI148-1**  
1 internal sensor  
(shown with included wall cradle)





**HI148-2**  
1 external sensor



**HI148-3**  
1 internal and 1 external sensor

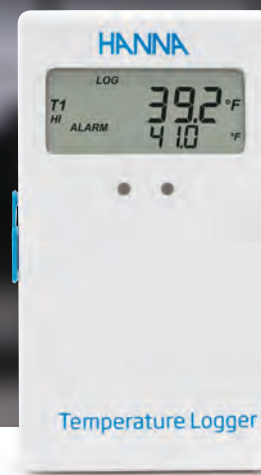

**HI148-4**  
2 external sensors

### Specifications

### HI148 Series

Model	Sensors	
<b>HI148-1</b>	T1 internal	-20.0 to 60.0°C / -4.0 to 140.0°F
<b>HI148-2</b>	T1 external	-40.0 to 125.0°C / -40.0 to 257.0°F
<b>HI148-3</b>	T1 internal T2 external	-20.0 to 60.0°C / -4.0 to 140.0°F -40.0 to 125.0°C / -40.0 to 257.0°F
<b>HI148-4</b>	T1 external T2 external	-40.0 to 125.0°C / -40.0 to 257.0°F -40.0 to 125.0°C / -40.0 to 257.0°F
Resolution		0.1°C (-40.0 to 100.0°C); 0.2°C (temp. >100.0°C); 0.1°F (-40.0 to 190.0°F); 0.3°F (temp. >190.0°F)
Accuracy		±0.5°C (-40.0 to 0.0 and 70.0 to 100.0°C); ±0.4°C (0.0 to 70.0°C); ±1.0°C (>100.0°C) ±1.0°F (-40.0 to 32.0 and 158.0 to 212.0°F); ±0.8°F (32.0 to 158.0°F); ±2.0°F (>212.0°F)
Additional Specifications	Probe	stainless steel probe with 1 m (3.3') silicone cable; 33.5 mm (1.32") length, 3.5 mm (0.14") diameter
	Battery Type / Life	1.5V AAA (3) / approximately 2 years of use
	Environment	-20.0 to 60.0°C (-4.0 to 140.0°F); RH 100%
	Dimensions	107 x 59 x 17 mm (4.2 x 2.3 x 0.7")
	Weight	130 g (4.6 oz)

### Ordering Information

**HI148-1** (1 internal sensor) is supplied with wall cradle, software, USB type A to C cable, batteries, and instruction manual.  
**HI148-2** (1 external sensor) is supplied with wall cradle, software, USB type A to C cable, batteries, and instruction manual.  
**HI148-3** (1 internal, 1 external sensors) is supplied with wall cradle, software, USB type A to C cable, batteries, and instruction manual.  
**HI148-4** (2 external sensors) is supplied with wall cradle, software, USB type A to C cable, batteries, and instruction manual.

HI144-10 • HI144

## T-Logger with Locking Wall Cradle

- **Compact waterproof data logger**
  - LCD displays temperature, high and low alarms, logging status and battery indicator
  - Wall mount with lock
  - USB docking cradle for programming and transferring of data (HI144-10)
- **Programming options**
  - Choice of start: From the PC, a specific date/time, or push button on T-Logger
  - Choice of measurement units: °C or °F to display on LCD
  - High and low alarm set points with indicators on LCD
  - Selectable logging interval in minutes and hours
  - Choice of data management: Store until full, fixed number or wrap around
- **Instrument status review:**
  - Battery life and days used
  - Serial number of device
  - Programmed device settings
- **PC software (using HI144002 USB docking cradle):**
  - Graphic user interface to program settings
  - Data export as an .xls file
  - Built in graphing that can be scaled with quick reference to programmed high and low alarm
- **Stores up to 8,000 measurements**
- **2-year battery life**

The monitoring of temperature is critical through all stages in food distribution. This includes from the time it is packaged and stored to transportation to the local market or restaurant. For cold food storage it is necessary to ensure that the product is always stored properly to maintain quality and for safety to prevent bacteria growth. The HI144-10 will help to be compliant in recording temperatures as part of a HACCP monitoring program.

For building maintenance, this logger can track environmental temperatures of an office or warehouse to ensure that heating or air conditioning thermostats are programmed correctly and hot or cold air is distributed evenly.

Using the supplied PC software HI144-10 can be programmed to record the temperature in intervals from 1 minute to 24-hours and can store up to 8,000 readings.

The HI144-10 is supplied with the HI144 T-Logger, USB cradle, wall mount with lock and software. Additional HI144 T-loggers can be ordered without the cradle and software. Each T-logger has its' own unique serial number to identify individual units.



HI144002 USB docking cradle  
included with HI144-10

wall cradle

Specifications	HI144
Range	-30.0 to 70.0°C/-22.0 to 158.0°F
Resolution	0.1°C/0.1°F
Accuracy	±0.4°C (-20 to 60°C); ±0.6°C (outside); ±0.7°F (-4 to 140°C); ±1.1°F (outside)
Calibration	factory-calibrated
Data Logging	up to 8,000 samples
Logging Interval	user selectable, from 1 minute to 24 hours
PC Connectivity	HI144002 docking cradle connected to PC with USB cable and running HI92144 software
Battery Type / Life	CR2032 3V lithium ion / approximately 2 years
Environment	0 to 50°C (32 to 122°F); RH 100% (IP67)
Dimensions	60 x 37 x 17 mm (2.4 x 1.5 x 0.7")
Weight	29.4 g (1 oz.) with battery
<b>Ordering Information</b>	<p><b>HI144</b> is supplied with HI144 T-Logger, CR2032 lithium ion battery, wall cradle, lock, and instruction manual.</p> <p><b>HI144-10</b> is supplied with HI144 T-Logger, HI144002 USB communication cradle, USB flash drive with HI92144 Windows® compatible software, CR2032 lithium ion battery, wall cradle, lock, and instruction manual.</p>



HI95654

HI9565

Pool  
Line

HI9564 · HI9565 · HI95654

## Thermo-hygrometers

with Dew Point and Calibration  
Data-Logging Probe

- Simultaneous RH and temperature measurements on a large, dual-line LCD display
- Selectable temperature unit (°C or °F)
- HI706023 dedicated temperature and RH probe with electronic sensor
- Quick connect probe
- Battery life indication and low battery detection
- Stability indicator
- Auto-off function
- Waterproof casing IP67
- MIN, MAX value and HOLD indicator
- Stability indicator

HI9564, HI9565 and HI95654 are portable thermo-hygrometers designed to measure temperature and Relative Humidity (RH). HI9565 and HI95654 present the added advantage of being able to calculate the dew point from the temperature and RH.

To ensure maximum protection against the effects of humidity and condensation, the instruments are housed in a rugged, water-resistant casing.

The temperature and RH probe is a "smart probe" which consists of a factory calibrated electronic sensor which requires no user calibration. Our "smart probes" will work with any of our meters without the need to recalibrate as the electronic sensor tracks the performance and stores the calibration history directly onto the probe.

Specifications	HI9564	HI9565	HI95654
RH	Range	0.0 to 100.0 % RH	
	Resolution	0.1 % RH	
	Accuracy	±2.5 % RH (0 to 90 % RH); ±3.5 % RH (90 to 100 % RH);	
Dewpoint Temperature (HI9565 only)	Range	-	-20.0 to 60.0°C / -4.0 to 140.0°F
	Resolution	-	0.1°C / 0.1°F
	Accuracy	-	±2°C / ±4°F (50 to 85 % RH and 15 to 40°C); ±4.5 °C / ±9 °F (outside)
Temperature	Range	-10.0 to 60.0°C / 14.0 to 140.0°F	
	Resolution	0.1°C / 0.1°F	
	Accuracy	±0.4 °C / ±0.8 °F	
Additional Specifications	Probe	HI706023 RH/temperature probe	
	Battery Type / Life	1.5V AAA / 10,000 hours of continuous use	
	Auto-off	User selectable: after 8 minutes, 60 minutes or disabled	
	Environment	0 to 60 °C (32 to 140 °F); 98 % RH non-condensing	
	Dimensions	154 x 63 x 30 mm (6.1 x 2.5 x 1.2")	
	Weight	196 g (6.91 oz.)	
<b>Ordering Information</b>	<b>HI9564, HI9565</b> and <b>HI95654</b> are supplied with HI706023 RH/temperature probe, 1.5V AAA batteries (3) and instruction manual.		



HI9564



**HI710028**  
Shockproof  
orange silicon  
rubber boot



**HI710030**  
Shockproof  
green silicon  
rubber boot



**HI710029**  
Shockproof  
blue silicon  
rubber boot

## Portable Lux Meter

- Three measurement ranges
- Water-resistant housing
- 200 hour battery life with battery level indicator

The HI97500, is a portable lux meter designed to perform light measurements simply and accurately. The instrument is supplied with a light sensor connected by a fixed 1.5 m coaxial cable to allow measurements to be taken from a distance without any user interference.

By simply pressing the RANGE key, users can switch among three ranges to choose the best resolution according to the environment being tested. The HI97500 lux meter has a rugged and water-resistant body for frequent outdoor use.

The HI97500 features a low battery indicator and automatic shut-off that turns the meter of after 7 minutes of non-use.

### Plant Light Requirements

Light provides the energy source needed for plants to manufacture food (photosynthesis). The amount of light is commonly measured in foot-candles (ft-c) or lux. Plants differ greatly in their light intensity requirements. Indoor plants are often classified by the amount of light necessary for growth:

- Low (minimum 1.1 Klx, .8 to 2.1 preferred for good growth)
- Medium (minimum 1.1 to 1.6 Klx, 2.1 to 5.4 preferred)
- High (minimum 1.6 to 10.8 Klx, 5.4 to 10.8 preferred)
- Very high (minimum 10.8 Klx, 10.8+ preferred)

About 1.1 Klx for 12 hours per day are necessary simply to maintain plant quality for one year and at least 2.1 Klx for 12 hours per day are necessary for foliage plants to manifest any benefit from fertilization.

While lack of sufficient light results in poor plant growth, too much light can also be harmful. Shade plants cannot tolerate excessively high light levels. When a plant receives too much direct light, the leaves bleach or scald, sometimes dying. This often happens after moving a plant outdoors in direct light. Any changes in light intensity should be gradual.

### The Quality of Light

Quality of light is very important in agriculture. Too little light (or luminous intensity) affects the quantity and quality of crop performance.

Luminous intensity is measured and reported in foot-candles (ft-c) or in lux (lx). One lux is equal to one lumen per square meter and one foot-candle is equal to one lumen per square foot. To convert measurements use the following formula:

$$\text{foot-candle} = \text{lux} \times 0.0929$$

$$\text{lux} = \text{foot-candle} \times 10.764$$



#### Specifications HI97500

Range	0.001 to 1.999 Klux 0.01 to 19.99 Klux 0.1 to 199.9 Klux
Resolution	0.001 Klux 0.01 Klux 0.1 Klux
Accuracy	±6% of reading ±2 digits
Sensor	human-eye-response silicon photodiode with 1.5 m coaxial cable (fixed)
Battery Type / Life	9V / approximately 200 hours of continuous use; auto-off after 7 minutes of non-use
Environment	0 to 50°C (32 to 122°F); RH 100%
Dimensions	164 x 76 x 45 mm (6.5 x 3.0 x 1.8")
Weight	180 g (6.3 oz.)
Ordering Information	<b>HI97500</b> is supplied with battery, protective case and instructions.
Accessories	<b>HI710015</b> blue shockproof rubber boot



**Introduction.....15.2**  
 Comparison Guides.....15.2  
 Product Spotlights.....15.5

**Fertigation .....15.6**  
 Fertigation Control Systems.....15.6

**Analyzers.....15.10**  
 PCA300 Family .....15.10

**Controllers.....15.16**  
 Pool Line with Cloud Connectivity .....15.16  
 Pool Line .....15.26, 15.40, 15.44  
 GroLine® .....15.32, 15.36  
 HI510 and HI520 Universal Process .....15.48  
     Compatible Probes .....15.58  
 Analog Controllers .....15.68  
 Mini Controllers .....15.78  
 Level .....15.94  
 Controller Pumps.....15.96

**Analog Transmitters ....15.100**  
 pH and EC .....15.101  
 pH and ORP.....15.102  
 Conductivity .....15.103

**Blackstone  
 Pumps .....15.104**

**Electrodes .....15.108**  
 Introduction.....15.108  
 Flat Tip Industrial .....15.113  
 Flat Tip Industrial Amplified.....15.116  
 Amplified .....15.118  
 Continuous Flow Thru.....15.120  
 Quick & Easy BNC Connector .....15.123  
 pH and ORP T-type Connection.....15.125  
 pH and ORP Immersion/In-line.....15.127  
 In-line Conductivity.....15.128  
 Flow-thru Conductivity .....15.129  
 Submersion Probes .....15.129  
 Stainless Steel Temp. Probes.....15.130

**Electrode Holders .....15.130**  
 In-line .....15.130  
 By-pass Loop.....15.131  
 Submersible .....15.132  
 In-line Applications.....15.133  
 Immersion .....15.134

### Fertigation Control Systems

	Time/volume Irrigation control programs	Irrigated sectors	Fertilization control by EC	Fertilization control by volume	pH correction	EC probes	pH probes	Agitators control	Filter control,differential presostate	Solar radiation sensor	Temperature sensor	Control/mixing of water sources	Volum. counters	Tank level sensors	On/off dosing valves	Motorized dosing valves	Pumps	Page
HI8001	10	32	4		acid or alk.	3	2	•	2 and 2	•			1 irrig.	4 fertilizer, 1 acid/alk., 1 mixing, 5 external	•		1 irrigation	15.9
HI8051	10	24	4		acid or alk.	2	1	•	2 and 2		1	•	1 irrig, 4 fert.	1 external, pH correction, 4 fertilizer, 3 incoming water	•	1pH correction, 4 fertilizer	3 Irrigation, 1 fertilizer	15.9

### PCA Series Analyzers

	Total and Free Chlorine	pH	ORP	Temperature	Logging	Alarm	PCconnection	Analog output	Passwordprotection	Page
PCA310	•				•	•	•	•	•	15.10
PCA320	•	•		•	•	•	•	•	•	15.10
PCA330	•	•	•	•	•	•	•	•	•	15.10
PCA340	•	•		•	•	•	•	•	•	15.10

### Application Specific Controllers

	Pool Line	GroLine®	Acid dosing	chlorine dosing	pH	ORP	EC/TDS	Temperature	Logging	Alarm	PC connection	Analog output	Password protection	Cloud connectivity	Page
BL120	•	•	•	•	•	•		•	•	•	•	•	•	•	15.26
BL121	•		•	•	•	•		•	•	•	•	•	•	•	15.26
BL122	•		•	•	•	•		•	•	•	•	•	•	•	15.16
BL123	•		•	•	•	•		•	•	•	•	•	•	•	15.16
BL100	•					•		•	•	•					15.40
BL101	•						•	•	•	•					15.44
HI981412		•				•		•	•	•					15.32
HI981413		•					•	•	•	•					15.36

### Digital Controllers

	Universal Mount (Wall/Panel/Pipe)	Channels	Panel Mount	pH	ORP	Conductivity	TDS	Temperature	Logging	Alarm	(S)ingle or (D)ual setpoint	ON/OFF control	Proportional control	PID control	SSR relay	Digital output	(S)ingle or (D)ual Analog output	Password protection	Sensor Check™	Automatic cleaning	Page
HI510	•	1	•	•	•			•	•	•	S or D	•	•	•		RS485	S or D	•	•	•	15.48
HI520	•	2	•	•	•			•	•	•	S or D	•	•	•		RS485	S or D	•	•	•	15.48

## Analog Process Controllers



	pH	ORP	Conductivity	Dissolved Oxygen	Recorder output	Backlight	(S)ingle or (D)ual setpoint	Dosing outputs	Alarm	Self diagnostics	Selectable dosing control	Adjustable overdosing control	Page
HI8510	•				•	•		1		•			15.70
HI8710	•				•	•	S	1	•	•	•	•	15.71
HI8711	•				•	•	D	2	•	•	•	•	15.72
HI8720		•			•	•	S	1	•	•	•	•	15.73
HI8512		•			•	•	-	-		•			15.74
HI8931			•		•	•	S	1	•	•	•	•	15.75
HI943500			•		•	•	S	1	•	•			15.76
HI8410				•	•	•	S	1	•	•	•	•	15.77

## Mini Controllers

Guide	pH	ORP	EC	TDS	Resistivity	Level	ATC	Resolution			Page
								1.0	0.1	0.01	
BL981411	•								•		15.80
BL931700	•									•	15.81
BL982411		•						•			15.82
BL932700		•						•			15.83
BL983313*			•				•	•			15.85
BL983320*			•				•	•			15.85
BL983322*			•				•	•		•	15.85
BL983317*			•				•	•		•	15.86
BL983327*			•				•	•		•	15.86
BL983315*				•			•	•			15.87
BL983319*				•			•	•			15.87
BL983321				•			•	•		•	15.87
BL983329*				•			•	•			15.87
BL983318				•			•	•		•	15.88
BL983324				•			•	•		•	15.89
BL983314					•		•	•		•	15.91
HI7871						•					15.94
HI7873						•					15.94
HI7874						•					15.95

\*4-20 mA galvanic isolated output models available



## Controller and Pump Systems

	pH	ORP	Proportional dosing	Dosing contacts	Alarm contact	Recorder output	Page
BL7916	•		•	1	1	•	15.98
BL7917		•	•	1	1	•	15.99

## Digital and Analog Transmitters



	pH	ORP	Conductivity	Output	Recorder output	ATC	LCD	Casing	Designed for HI8000 series	Page
HI98143-01	•		•	0-1 V		•		IP54		15.101
HI98143-04	•		•	0-4 V		•		IP54		15.101
HI98143-20	•		•	4-20 mA		•		IP54		15.101
HI98143-22	•		•	4-20 mA		•		IP54	•	15.101
HI8614N	•			4-20 mA	•	•		IP65		15.102
HI8614LN	•			4-20 mA	•	•	•	IP65		15.102
HI8615N		•		4-20 mA	•			IP65		15.102
HI8615LN		•		4-20 mA	•		•	IP65		15.102
HI8936 series			•	4-20 mA	•	•		IP65		15.103



HI510 and HI520

## Universal Process Controller

- Single (HI510) and Dual-channel (HI520)
- Waterproof IP65 (NEMA 4X) enclosure
- Large backlit LCD
- Audible alarm
- Universal mounting
- Universal Hanna digital probe

HI510 and HI520 are advanced universal process controllers that can be configured for many applications requiring monitoring and/or control of process parameters. These controllers offers wall, pipe and panel mounting options.

See page 15.48



*Pool  
Line*

BL100

## pH Controller and Dosing Pump

*for Swimming Pools, Hot Tubs, and Spas*

BL100 pH Controller and Dosing Pump is a system engineered for maintaining the pH of swimming pools, hot tubs, and spas.

See page 15.40



*GroLine®*

HI981413

## Nutrient Dosing System

*for Nutrient Solutions and Irrigation Water*

HI981413 Nutrient Dosing System is engineered for maintaining the concentration of fertilizer in the nutrient solution used in hydroponics and irrigation water.

See page 15.101

HI8000 Series

# Fertigation Control Systems

- **Connectivity**
  - PC compatible
- **Alarm**
  - Alarm and warning system
- **Backlight**
  - Backlit, LCD display



## Variety and customization of models

A wide variety of models are available to cover the requirements of specific fertigation applications. The HI8000 series are fully customizable and upgradable on the hardware and program level.

HI8000 series models can be selected based on the irrigation and fertilization type of control along with the additional features that are proper for the specific application.

Some of the most important criteria in selection of controller type are: number of irrigated sectors: 8, 16, 24, 32; type of irrigation control: in volume or in time; type of fertilizer control: by EC, by Volume,



ratiometric; type of pH correction: acid or alkaline; control of incoming water: one, two or three sources of water; control of dosing with venturi or motorized electrovalves; redundancy of the conductivity or pH probes; mounting solution: panel or wall mounted.

## Irrigation control

Irrigation control differs based on the type of control: by irrigation water volume or by irrigation time; the number of sectors that have to be irrigated, the available sources of water for irrigation - one or more with or without reusing the irrigation drain water.

Irrigation control is started by opening the irrigation valves and starting the main irrigation pump. The control of all these elements is performed by the controller based on concepts of irrigation programs.

## Irrigation programs

Up to 10 irrigation programs can be set by the user with different irrigation parameters: irrigation periods, type of irrigation control, irrigated sectors and volume or irrigation time specified for each sector, conditions to start irrigation such as time, accumulated solar radiation, low level in tanks (hydroponic crops), temperature variations, linked to another program, priority of program, number of repetitions. For irrigation water, each program has a defined pH set point, EC set point (if the quantity of fertilizer is dosed according with conductivity), and receipt of fertilizers. Control of agitators is specified by programs according with the irrigation periods.

## Irrigation water

The quality of irrigation water is assured by proper control of pH and the quantity of nutrients (fertilizers) present in irrigation water.

## Fertilization control

Fertilizer can be dosed during irrigation using the Venturi tubes principal or with motorized valves. The control of the quantity of dosed fertilizer can be performed using the volume counters. The system supports dosing from up to 4 fertilizer tanks with specific receipts.

The concentration of the fertilizer in irrigation water can be controlled based on the conductivity reading, proportional with irrigation water based on the receipt or ratiometric, in which case the certain quantity of fertilizers are added with the amount of programmed water.

## pH control

The pH control is performed in order to adjust the pH of water to the irrigation program set point.

The pH correction can be performed with alkaline or acid solution based on the characteristic of the incoming water.

The control of pH and EC is performed with PID, PI or proportional control. The tuning of the PID control can be accomplished by the user manually, or automatically by the PID auto-tuning feature.

## Agitators and filter cleaning

The automatic control of agitators used in fertilizers tanks and filter cleaning system complete the needs of a standard fertigation system.

In order to keep the fertilizer concentration constant before and during the irrigation program, the fertilizers are mixed in their tanks based on the agitators program. The system can manage up to two filters mounted to protect the probes and in-line dosing elements.

With differential presostates, the filters are monitored and when necessary, the irrigation programs are automatically suspended and washer filter cleaning is started. This process removes any deposits and sediments that may appear on filters to increase the systems life.

## Redundancy of EC and pH probes

For safety reasons, the systems can be equipped with 2 conductivity probes and two pH electrodes in redundancy so that the system can generate an alarm in the case of reading differences between them. A third conductivity probe can be mounted to verify and compensate the incoming water conductivity.

## Logging system

The logging of the controller can be selected on three levels: input reading variations, statistics of reading (average of pH and EC) or events (start of programs, opening valves, ...).

## Alarm system

The alarms of these systems are related to measured water quality parameters like conductivity and pH: out of range, differential reading between redundant probes; over dosing of conductivity or acid or alkaline correction solution, tanks at low level or no dosing detected by counter movement. Similar alarms can be generated after the units self-diagnostic tests are run.



## Sensor connections

All the sensors: EC, pH, temperature are connected to the controller via transmitters.

pH and EC are temperature compensated on the transmitter level. The output of analog transmitters can be calibrated at two points for pH and conductivity. Also, the controller offers a calibration in two points for pH and one point for conductivity.

## User interface and digital connection

The user interface is based on an 4 x 20 character line LCD, organized for settings and consultancy. The UI has multi-language support.

The RS232 connection permits the connection to a PC.

## Internal back-up system

The systems internal back-up power system offers a special feature; in the case of losing external power, the controller will stop the irrigations and memorize the irrigation programs that were not performed. The controller will start from the uncompleted programs after power has been restored. The programs will be executed based on their priority level with full respect of the quantity of irrigation water, pH level, and concentration of fertilizers.

Additional features that can be found are control of the external power supply and control of mixing of different water sources (clean water, drain irrigation water).

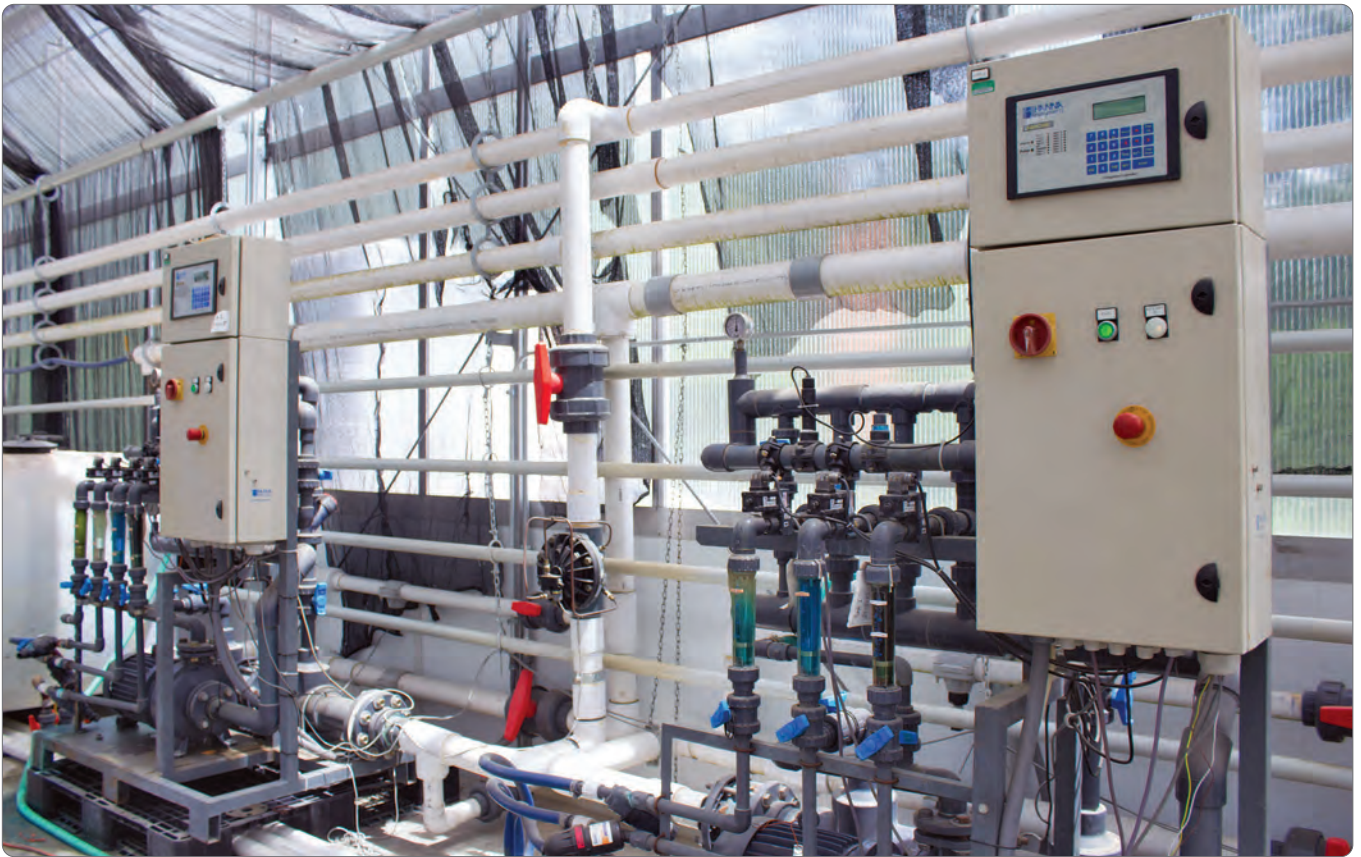

Two panel mount units used in a fertigation system

### HI8001 (panel mount) models

The HI8001 fertigation controller models provide up to 10 programs to irrigate up to 32 sectors using time or volume irrigation control. Each irrigation program has one pH and one EC setpoint. The start condition of the program, the irrigation sectors and the time or volume for each sector are user defined. The irrigation water is pH corrected based on the pH control, with acid or alkaline solution and can contain nutrients for crops based on up to 4 fertilizer receipts. Correction of time or volume of irrigated water can be based on accumulated solar radiation or can be manually requested by user. Agitator control and filter cleaning control are performed automatically. The instruments read up to 3 EC probes, one to verify the incoming water EC, and the other two are in-line redundant for safety to measure the current irrigation water EC. The two pH electrodes are mounted in-line redundant for safety to read the irrigation water pH. The instruments provide an alarm system and logging organized on user selectable three levels.

### HI8051 (panel mount) model

The HI8051 fertigation controller provides up to 10 irrigation programs to irrigate up to 24 sectors using time or volume control. Each irrigation program has one pH and one EC setpoint. The start condition of the program, the irrigation sectors and the time or volume for each sector are user defined. The irrigation water is pH corrected based on the pH control with acid or alkaline solution and can contain nutrients for crops based on up to 4 fertilizer receipts. Fertilizer dosing is performed based on the EC, volumetric or ratiometric control. Another important feature is the correction of irrigated water volume or time based on accumulated solar radiation or manually requested by user. Agitator control and filter cleaning control is performed automatically. The instrument reads up to 3 EC probes, one to verify the water incoming

EC, and the other two redundant in-line for safety, to measure the current irrigation water EC. The two pH inputs are mounted in-line redundant for safety to read the irrigation water pH. This instrument provides an alarm system and logging organized on three user selectable levels. An important added feature is this models ability to mix 3 sources of incoming water. Fresh water, reused water and all dosing are performed based on the motorized valves that are activated by motors that allow different flows of the fertilizers, acid and alkaline solutions used for pH correction.



HI98143 pH/EC Transmitter

Models	HI8001	HI8051
Irrigation control	Time/volume control, 10 programs/5 priority levels with up to 99 repetition	Time/volume control, 10 programs/5 priority levels with up to 99 repetition
Irrigation start condition	By Time, by solar radiation, by 5 external tank low level	By Time, by solar radiation, by 5 external tank low level
Fertilization control	By EC	By EC, By volume, Ratiometric
Fertilizers	Up to 4 valves	Up to 4 motorized valves
pH control/correction	Acid or alkaline	Acid or alkaline, motorized pump
Agitators control	Yes	Yes
Filter control/cleaning	2 differential presostate/2 filter cleaning relays	2 differential presostate/2 filter cleaning relays
Fertilizer tank levels/counters control	Level	Level and counters
Irrigation counter	Yes	Yes
Acid/Alkaline tank level/counter control	Level	Level and counter
EC inputs	Up to 3, 0.0 to 10 mS/cm	Up to 2, 0.0 to 10 mS/cm
pH inputs	Up to 2, 0.0 to 14.0 pH	1, 0.0 to 14.0 pH
Temperature Compensation	EC, pH	EC, pH
Solar radiation input	1; 0 to 2000 W/m2	No
Temperature	No	1
Wind speed	No	No
Engine power back-up	No	No
Irrigated sectors	Up to 32	Up to 24
Mixing source of water	No	Yes, 3 sources
PC connectivity	RS 232	
Alarms	Yes, user selectable levels	
Logging	Yes, three level	
Power Supply	115V/220V ±10% 50Hz/60Hz	
Environment	wall mounted: NEMA 4X specifications	
Dimensions	wallmounted: 280 x 330 x 165 mm (11.2 x 13.2 x 6.6"); panel mounted: 178 x 260 x 116 mm (7.1 x 10.4 x 4.6")	
Weight	wall mounted: 4.95 Kg (11 lb.); panel mounted: 3.4 Kg (7.5 lb.)	

### Ordering Information

Each HI8000 Series model is supplied instructions.

#### Choose your configuration:

**HI8001-0100U** Fertigation controller with priority for pH and EC, panel mount, 8 sectors, English, 115V.

**HI8001-0200D** Fertigation controller with priority for pH and EC, panel mount, 16 sectors, English, 230V.

**HI8001-0400U** Fertigation controller with priority for pH and EC, panel mount, 32 sectors, English, 115V.

**HI8051-0300D** Acid based fertigation controller with dual pH control, differential EC control, actuator control, multiple dosing and irrigation pump control, panel mount, 24 sectors, English, 230V.

<b>Required Accessories</b>	<p><b>HI98143-22</b> pH/EC isolated transmitter, 4-20 mA sourcing current output  <i>1 transmitter is needed in configuration with 1 EC probe and 1 pH probe (no probe redundancy feature)</i>  <i>2 transmitters are needed in configuration with 2 EC probes and 2 pH probes (for probe redundancy feature)</i>  <i>3 transmitters are needed in configuration with 3 EC probes and 2 pH probes (for probe redundancy feature and EC water incoming compensation)</i></p>
<b>Recommended Accessories</b>	<p><b>HI1001</b> "flow-thru", double junction pH electrode with BNC connector and 3 m (10') cable.  <i>1 or 2 electrodes are needed (2 electrodes for probe redundancy feature)</i></p> <p><b>HI3001</b> "flow-thru", 4 platinum ring EC probe with built-in temperature sensor &amp; 3 m (10') cable.  <i>1, 2 or 3 probes are needed (2 for probe redundancy feature; 3 for probe redundancy feature and EC water incoming compensation)</i></p> <p><b>HI60542</b> Electrode Holder for Direct Pipe (Order according with the total amount of ordered probes)</p> <p><b>HI710005</b> 115 VAC to 12VDC power adapter</p> <p><b>HI710006</b> 230 VAC to 12VDC power adapter</p>

PCA300 Family

## Chlorine, pH, ORP and Temperature Analyzers

- Backlit LCD display
- Nema 4X protection
- DPD chlorine measurement method
- Colorimeter diagnostics
- Reagent reminder
- Amplified pH/temperature probe (excl. PCA310)
- Data logging of up to 3500 measurements
- GLP data for review of calibration information
- Digital RS485 output
- Two analog outputs for recording or dosing devices (PCA340)
- Two dosing relays
- SPDT alarm relay
- SPDT system error relay
- Warning messages



The PCA family are process analyzers for the continuous measurement of chlorine, pH (PCA320, PCA330, PCA340 only) and temperature. These analyzers feature built in data logging, RS485 digital output, dosing relays, and alarm relays packaged in a wall mount Nema 4x enclosure. The PCA340 also features two analog outputs.

This family uses DPD Colorimetric method in which N, N-Diethyl-p-phenylenediamine indicator and a buffer are mixed together with the sample. The resulting chemical reaction causes a magenta color to form in the presence of chlorine. The color intensity is proportional to the concentration. The color intensity is measured photometrically (light source at a specific wavelength and a photodetector) and converted to chlorine concentration, in mg/L, which is displayed on the front panel. The sampling interval for

chlorine measurement is adjustable from 3 to 90 minutes. These analyzers have a dosing relay for the addition of chlorine by a dosing pump or chlorine generator when a reading is below the programmable set point. The technology used by this family for chlorine measurement is the same as that found in portable and benchtop colorimeters providing for consistent results when performing process verification with one of those types of meters.

The PCA320, PCA330 and PCA340 also utilize the HI1005 amplified pH electrode with a built in pt100 temperature sensor and matching pin to measure both pH and temperature. The built in amplifier and matching pin provide for exceptional performance against any electrical noise generated by pumps and motors. These analyzers have a programmable dosing relay for the adjustment of pH. The

dosing relay can be activated by either on/off or proportional control.

The PCA340 features two selectable 0-20 or 4-20 mA signal output that are scalable for the transmission of readings to external recording devices. The analog outputs can also be set for dosing and used with dosing pumps that accept a 4-20 mA analog input. The analog outputs can be used for any of the three measured parameters.

Through the system setup menu, users have the ability to enable or disable the low and high level of alarms for all parameters. The PCA family also offers overdosing protection that generates an alarm if something within the system is not working properly. The system will stop processes until the user corrects the error.



### Backlit LCD Display

The PCA family has a backlit display that is easy to read from a distance and allows for up to three parameters to be displayed at a time.



### Nema 4X Protection

These analyzers are enclosed in waterproof casing for superior protection against the elements. The front door of the case has a window for the measurement display while also shielding the DPD reagents from UV light to prevent premature degradation.

### DPD Chlorine Measurement Method

The DPD colorimetric method is one of the most common and reliable methods to measure chlorine. The PCA family can use either free or total chlorine reagents and allow for 16,000 measurements to be performed.

### Reagent Reminder

The PCA family has a reagent reminder feature to alert the user when the reagents are running low. When the reagents are changed the counter is reset and the meter automatically tracks the number of readings performed.

### Colorimeter Diagnostics

Advanced diagnostics allow for easy troubleshooting of the colorimeter. In the setup menu it is possible to select an option that allows the user to determine the difference between a dark read (LED off) and a blank read (LED on). These analyzers also automatically perform this check in order to determine when to alert the user that the sample cell needs to be cleaned.

### Amplified pH/Temperature Probe (PCA320, PCA330, PCA340)

An integrated pt100 temperature sensor allows for automatic temperature compensation of pH measurements and allows for monitoring temperature as well. The built in amplifier and matching pin provides for exceptional performance where other probes fail when placed in line with pumps and motors.

### Data Logging

The analyzers can store up to 3500 readings (at least 7 days worth of records when set to a 3 minutes sampling interval) that can be reviewed or downloaded to a Windows compatible PC using the HI92500 software and the RS485 serial port. Logged records contain the date time and reading of all parameters measured along with any alarm status.

### GLP Data

The GLP data allows for the user to review the data and time for the last Chlorine and pH calibration.

### Digital RS485 Output

These analyzers have a RS485 digital output that allows for connection to a Windows compatible PC running the HI92500 software. The software allows for remote monitoring, review of logged data, events and errors, and executing setup options.

### Two Analog Outputs (PCA340)

The PCA340 features two selectable 0-20 or 4-20 mA signal output that are scalable for the transmission of readings to external recording devices. The analog outputs can also be set for dosing and used with dosing pumps that accept a 4-20 mA analog input. The analog outputs can be used for any of the three measured parameters.

### Two Dosing Relays

The dosing relays of these analyzers can be connected to a pH and/or chlorine dosing pumps. The chlorine relays are proportionally controlled while the pH relay can be set for on/off or proportional control. The proportional control offers very fine control of dosing to prevent any overshoot and wastage of chemicals.

### Alarm Relay

One SPDT alarm relay is provided that can be activated by adjustable upper and lower chlorine, pH and temperature limits.



### Error Relay

One SPDT error relay is provided and is activated when an error is present including a problem with the colorimeter such as when the reagent counter has reached zero, or when a reading is outside the range for a measured parameter.

### Warning Messages

Error messages are displayed when the reagents are expired or low and if the colorimeter cell needs to be cleaned.

Specifications	PCA310	PCA320	PCA330	PCA340	
Free and Total Chlorine	Range	0.00 to 5.00 mg/L (ppm)	0.00 to 5.00 mg/L (ppm)	0.00 to 5.00 mg/L (ppm)	0.00 to 5.00 mg/L (ppm)
	Resolution	0.01 mg/L (ppm)	0.01 mg/L (ppm)	0.01 mg/L (ppm)	0.01 mg/L (ppm)
	Accuracy	± 8% or ±0.05 mg/L whichever is greater	± 8% or ±0.05 mg/L whichever is greater	± 8% or ±0.05 mg/L whichever is greater	± 8% or ±0.05 mg/L whichever is greater
	Calibration	one-point process calibration			
	Minimum Detectable Level	0.05 mg/L			
	Sampling Rate	adjustable from 3 to 90 minutes			
	Dosage	proportional relay or 4-20 mA output			
	Delta (Δ)	selectable from 0.1 to 5 mg/L (ppm)			
pH	Range	-	0.00 to 14.00 pH	0.00 to 14.00 pH	0.00 to 14.00 pH
	Resolution	-	0.01 pH	0.01 pH	0.01 pH
	Accuracy	-	±0.05 pH	±0.05 pH	±0.05 pH
	Calibration	-	one or two points or in line calibration		
	Dosing Rate	-	adjustable from 3 to 120 seconds		
	Dosage	-	ON/OFF or proportional, relay or 4-20mA output		
	Delta (Δ)	-	selectable from 0.10 to 2.00 pH		
	Hysteresis	-	selectable from 0.05 to 2.00 pH		
ORP	Range	-	-	0 to 2000 mV	-
	Resolution	-	-	1 mV	-
	Accuracy	-	-	±1 mV	-
Temperature	Range	-	5.0 to 75.0°C (41.0 to 167.0°F)	5.0 to 75.0°C (41.0 to 167.0°F)	5.0 to 75.0°C (41.0 to 167.0°F)
	Resolution	-	0.1 °C (0.1°F)	0.1 °C (0.1°F)	0.1 °C (0.1°F)
	Accuracy	-	±0.5°C (±1.0°F)	±0.5°C (±1.0°F)	±0.5°C (±1.0°F)
Additional Specifications	Analog Output (Dosing)	(1) 4-20mA		(2) 4-20mA	
	Recorder Output	(1) 0-10 mV, 0-100 mV, 0-1 V, 4-20mA		(2) 4-20mA	
	PC Connectivity	RS485 port, galvanically isolated			
	Baud Rate	1200, 2400, 4800, 9600 bps			
	Data Logging	up to 3500 data points			
	GSM Alarm	2 numbers, alarm SMS, info SMS, warning SMS			
	Alarm Relay	SPDT contact with 5A, 230V resistive load			
	Dosing Relay	SPDT contact with 5A, 230V resistive load			
	System Error	SPDT contact with 5A, 230V resistive load			
	Sample Inlet Pressure	0.07 to 4 bar with no external pressure regulator (for pressure exceeding four bar an external pressure regulator is required)			
	Sample Flow	100 to 300 mL/min			
	Sample Temperature	5 to 40°C (41 to 104°F)			
	Sample Inlet/Outlet Connection	12mm (1/2") male NPT fitting			
	Drain Connection	10mm (3/8") barb			
	Power Supply	115 VAC ±10% or 230 VAC ±10%; 50/60 Hz; 20 VA			
	Enclosure	NEMA-4X standard, molded fiberglass polyester with transparent Lexan window			
	Dimensions / Weight	318 x 267 x 159 mm (12.5 x 10.5 x 6.25") / 5 kg (11 lb.) without reagents			
Ordering Information	Each PCA300 series model is supplied with reagent bottles (2), reagent caps (2), 1 DPD compound powder, tubing and instructions.;				
	<b>PCA310-1</b> Free & total chlorine analyzer/control (115V); <b>PCA310-2</b> Free & total chlorine analyzer/control (230V);	<b>PCA320-1</b> Free & total chlorine analyzer/control, pH control, temperature (115V); <b>PCA320-2</b> Free & total chlorine analyzer/control, pH control, temperature (230V);	<b>PCA330-1</b> Free & total chlorine analyzer/control, pH control, ORP monitoring, temperature (115V); <b>PCA330-2</b> Free & total chlorine analyzer/control, pH control, ORP monitoring, temperature (230V)	<b>PCA340-1</b> Free & total chlorine analyzer/control, pH control, temperature with dual analog outputs (115V); <b>PCA340-2</b> Free & total chlorine analyzer/control, pH control, temperature with dual analog outputs (230V)	
Recommended Probes	<b>HI1005</b>	Flow-thru Monitoring pH electrode			
	<b>HI2008</b>	Flow-thru Monitoring ORP Electrode			





## Swimming Pools and Chlorine for Disinfection

In regards to swimming pool treatment, disinfection or sanitizing basically means to rid the pool of bather contamination, destroy bacteria, and control nuisance organisms like algae, which may occur in the pool, filtration equipment, and piping. Of the many techniques used (chlorine, bromine and iodine dosing systems), chlorine is the most common.

### Chlorine

Chlorine is a strong oxidizing agent that destroys mostly organic pollutants and bacteria and can combine with nitrogen containing compounds, forming chloramines. When dosing chlorine for disinfection, only a portion of the dosed chlorine remains active to actually continue the disinfection process.

When free chlorine combines with a nitrogen containing compound it becomes a less efficient disinfectant called chloramines. The addition of these two parts gives total chlorine. The target is to keep free and total chlorine equal, and thus to maintain the combined chlorine concentration (chloramines) near zero. The presence of chloramines is not desired because of the distinctive 'swimming pool' smell caused by

combined chlorines like di-chloramines. Beside this unpleasant odor, chloramines can irritate the eyes and the mucous membranes.

Commercial chlorine for disinfection may be available as a gas ( $\text{Cl}_2$ ), a liquid like sodium hypochlorite or bleach ( $\text{NaOCl}$ ) or in a solid state like calcium hypochlorite, chloro-hydantoin or chloro-cyanuric acid compounds. These compounds, once dissolved in water do establish equilibrium between the hypochlorous acid ( $\text{HOCl}$ ) and the hypochlorite ions ( $\text{OCl}^-$ ). Although both forms are considered free chlorine, it is the hypochlorous acid that provides the strongest disinfecting and oxidising characteristic of chlorine solutions; the amount of hypochlorous acid in chlorinated water depends upon the pH value of the solution. Changes in pH value will affect the  $\text{HOCl}$  equilibrium in relation to the hydrogen and hypochlorite ion;  $\text{HOCl}$  decreases and  $\text{OCl}^-$  increases as pH increases. At a low pH, almost all the free chlorine is in the molecular form  $\text{HOCl}$  and at a pH of around 7.5, the ratio between  $\text{HOCl}$  and  $\text{OCl}^-$  is 50:50. Since the ionic form  $\text{OCl}^-$  is a slow acting sanitizer while the molecular  $\text{HOCl}$  is a fast acting, it is important to regularly measure the pH. As a general rule a pH of about 7.2 is recommended to maintain fast acting disinfection conditions.



Graphic display with backlight

LED indicators for different working modes

Keyboard for all parameter settings

Peristaltic pump for accurate reagent dosage

Incoming pressure regulator

Buffer and indicator reagents for DPD method

Hinged cover with window for easy maintenance

Measurement cell with LCD light source

Port to quickly drain the measurement cell at the end of the cycle

External enclosure according to NEMA 4X standard for best protection



## Parts

<b>HI70473</b>	PCA tubing kit, pressure regulator to drain (2). Each kit includes: transparent Tygon tubes 86L x 3.2ID mm (3.4 x 0.1") (Length x Internal Diameter) <b>(1, 2)</b> and 105 x 9.5 mm (4.1 x 0.4") <b>(3)</b>
<b>HI70474</b>	PCA peristaltic pump tubing kit (6). Each kit includes: non-transparent C-flex tubes 55L x 0.8ID mm (2.1 x 0.03") <b>(5)</b>
<b>HI70475</b>	PCA peristaltic pump tubing kit (2). Each kit includes: non-transparent C-flex tubes 55L x 0.8ID mm (2.1 x 0.03") <b>(5)</b>
<b>HI70476</b>	PCA reagent bottle tubing kit (6). Each kit includes: non-transparent C-flex tubes 155L x 0.8ID mm (6.1 x 0.03") <b>(11)</b>
<b>HI70477</b>	PCA tubing set for measuring cell (2). Each set includes: non-transparent C-flex tube 50L x 0.8ID mm (2.0 x 0.03") <b>(8)</b> and Y strainer <b>(7)</b>
<b>HI70478</b>	PCA tubing kit, bottle to pump (6). Each kit includes: non-transparent C-flex tube 150L x 0.8ID mm (5.9 x 0.03") <b>(4)</b>
<b>HI70479</b>	PCA tubing kit, pump to Y strainer (6 pcs). Each kit includes: non-transparent C-flex tube 150L x 0.8ID mm (5.9 x 0.03") <b>(6)</b>
<b>HI70482</b>	PCA filters. The kit includes 0.5 µm and 50 µm filters <b>(13)</b>
<b>HI70495</b>	incoming pressure regulator
<b>HI70496</b>	Replacement filter, 0.5 µm <b>(15)</b>
<b>HI70497</b>	Replacement filter, 50 µm <b>(16)</b>
<b>HI70483</b>	PCA complete tubing kit. The kit includes: non-transparent C-flex tubes <b>(4, 6)</b> 150L x 0.8ID (5.9 x 0.03") (4 pcs), non-transparent C-flex tubes <b>(5)</b> 55L x 0.8ID (2.1 x 0.03") (2 pcs), non-transparent C-flex tubes <b>(8)</b> 50L x 0.8ID (2.0 x 0.03") and Y strainer <b>(7)</b>
<b>HI70484</b>	PCA complete tubing kit (3). Each kit includes: non-transparent C-flex tubes <b>(4, 6)</b> 150L x 0.8ID (5.9 x 0.03") (4 pcs), non-transparent C-flex tubes <b>(5)</b> 55L x 0.8ID (2.1 x 0.03") (2 pcs), non-transparent C-flex tubes <b>(8)</b> 50L x 0.8ID (2.0 x 0.03"), Y strainer <b>(7)</b>
<b>HI70485</b>	PCA stirrer motor
<b>HI70486</b>	PCA stirring bar <b>(2)</b>
<b>HI704871</b>	Measuring cell <b>(9)</b>
<b>HI70488</b>	Electrovalve, 24VAC/60Hz <b>(12)</b>
<b>HI70489</b>	Electrovalve, 24VAC/50Hz <b>(12)</b>
<b>HI70492</b>	Electrode holder (PCA330)
<b>HI70493</b>	Closing cap for electrode holder

## Electrodes

<b>HI1005</b>	Amplified pH electrode with Matching Pin and Pt100 <b>(14)</b> (PCA320/330 only)
<b>HI2008</b>	Amplified ORP electrode with Matching Pin <b>(17)</b> (PCA330 only)

## Reagent Sets

<b>HI70431</b>	Total Chlorine reagent set for PCA (buffer citrate), 500 mL (2)
<b>HI70481</b>	Total chlorine reagent set for PCA, 500 mL (2) + 5 powder sachets (DPD)
<b>HI70491</b>	Total chlorine reagent set for PCA, 500 mL (2) + 5 powder sachets (DPD)
<b>HI70430</b>	Free chlorine reagents set for PCA (the most stable), recommended for long term measurements, 500 mL (2) + 6 g powder
<b>HI70480</b>	Free chlorine reagents set for PCA, recommended for short term measurements, 500 mL (2) + 5 sachets (DPD)
<b>HI70490</b>	Free chlorine reagents set for PCA, 500 mL (2) + 5 sachets (DPD)
<b>HI70452</b>	DPD reagent, 5 sachets

## Solutions

<b>HI70460</b>	Total chlorine indicator solution for PCA, 500 mL*
<b>HI70461</b>	Total chlorine buffer solution for PCA, 500 mL
<b>HI70450</b>	Free chlorine indicator solution for PCA, 500 mL*
<b>HI70451</b>	Free chlorine buffer solution for PCA, 500 mL
<b>HI7004L</b>	pH 4.01 buffer solution, 500 mL
<b>HI7006L</b>	pH 6.86 buffer solution, 500 mL
<b>HI7007L</b>	pH 7.01 buffer solution, 500 mL
<b>HI7009L</b>	pH 9.18 buffer solution, 500 mL
<b>HI7010L</b>	pH 10.01 buffer solution, 500 mL
<b>HI7020L</b>	200-275 mV buffer solution, 500 mL
<b>HI7091L</b>	Pretreatment reducing solution, 500 mL
<b>HI7092L</b>	Pretreatment oxidizing solution, 500 mL
<b>HI70300L</b>	Storage solution, 500 mL
<b>HI7082</b>	3.5M KCL electrolyte, 30 mL
<b>HI7061L</b>	Electrode cleaning solution, 500 mL

## Software

<b>HI92500</b>	Windows® compatible software
----------------	------------------------------

\* After addition of 5 powder sachets (HI70452-0)



BL122 • BL123

## pH/ORP Controllers

*with Cloud Connectivity*

BL122 and BL123 are designed to maintain constant pH and disinfectant levels in swimming pools, hot tubs, and spas and offer the added benefit of allowing remote connection and access to devices via the Hanna Cloud web app.

These controllers are available in two configurations. The basic version is the in-line model which allows for direct installation of probe and chemical injection fittings into existing piping. A panel mounted version with a bypass flow cell is also available. The bypass flow cell allows for calibration and maintenance of the probe without having to shut down the recirculation pump.

For compliance monitoring, BL122 and BL123 have a built-in datalogger. Measurement readings are logged every 10 seconds with a new log starting for each new day or when the instrument is calibrated. Logged data include pH, ORP, and temperature values, last calibration data, setup configuration, and any event data.

For BL123 models, three 4-20 mA analog outputs are available for users that wish to connect to an

external chart recorder or datalogger to monitor any of the three measured parameters. The outputs are scalable, offering increased flexibility and better resolution as needed.

The chlorine level is measured based on the ORP or REDOX principle. An increase of the ORP value correlates with an increase of the free chlorine level. pH and disinfectant testings are made together for more efficient disinfection and control. The efficacy of sanitizers, is dependent on a controlled pH value. The ORP value is the most consistent indicator of the sanitizing effectiveness of the pool/hot tub or water treatment. Typically 650-750 mV at 7.2 pH indicates proper water treatment (all harmful bacteria are killed in less than 1s). pH and disinfectant testings are made using the HI1036-1802 combined electrode installed in-line or in flow cell. To prevent the ground loop effects from causing erratic readings and damage to the system the electrode has a matching pin considered the "earth ground" connection. It was specially designed to detect the broken electrode based on a shifted isopotential value. The HI1036-1802 uses a Ag/AgCl reference with 3.5 M KCl. The ORP values are referenced to it.

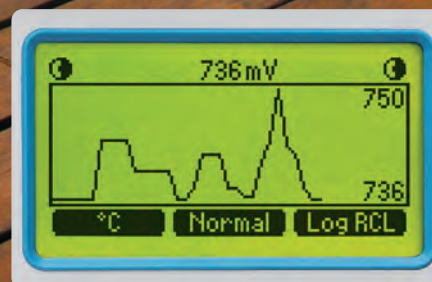
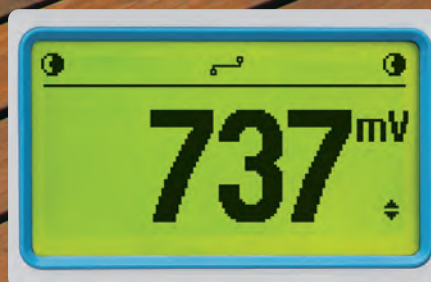
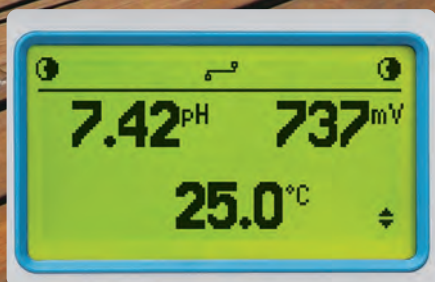

### Three Display Modes

The versatile display of the BL122 and BL123 allows for three display modes. The LCD can display all three parameters at one time, a 3-second cycle of single parameters, or a real-time plot screen with options for parameter selection, zooming, and log recall.

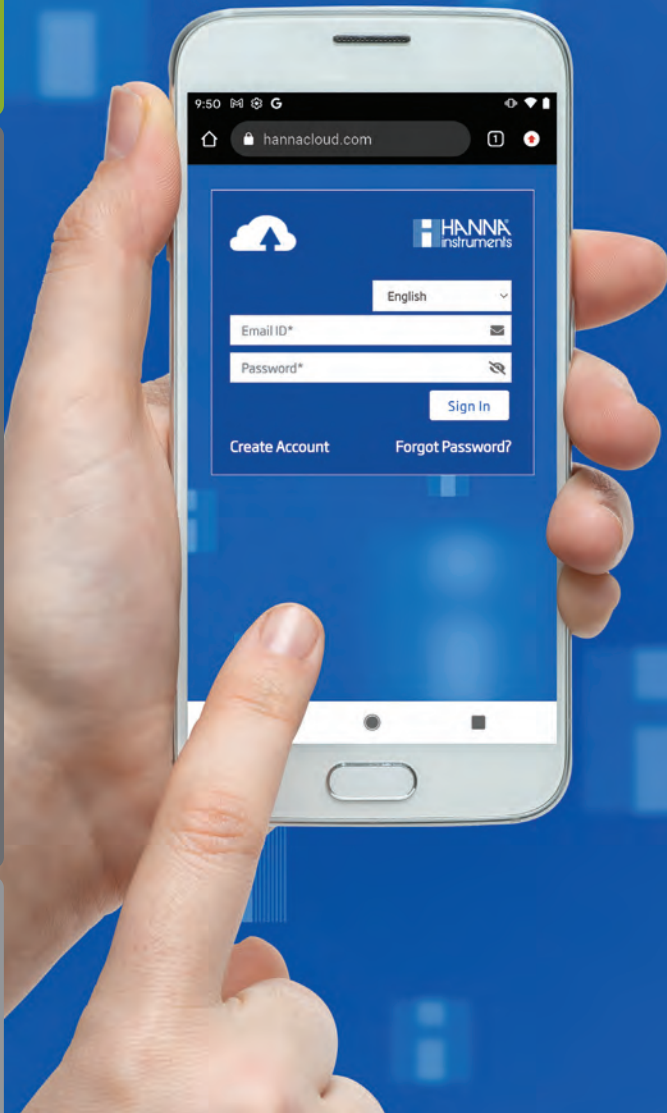

## Keep Track Anywhere with Hanna Cloud Connectivity

Hanna Cloud is a web based application that connects you to measurement devices such as the BL122 and BL123. Measurements and data storage are accessible from your PC, tablet or phone. Multiple registered devices may be connected to Hanna Cloud.

Measurements, trends, history, device settings, alarms and messages are transmitted to your "Dashboard" as your instrument measures and controls your process.

Multiple secondary users may also be added to your device account to monitor measurements and receive email or pop-up messages from your process device.

Hanna Cloud incorporates security for your personal information. We protect your information using technical and administrative security measures to reduce risks of loss or misuse. These include (but are not limited to), a secured connection, device identity registration, and password encryption.



Hanna Cloud application is compatible with most modern web browsers.

## Hanna Cloud Controller Features



### Settings

Configure your settings for cloud connectivity.

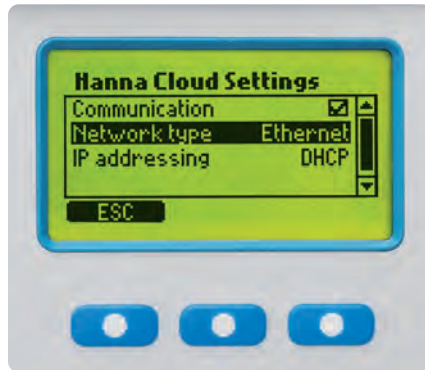

### Hanna Cloud Options

Choose from Static or DHCP connection.

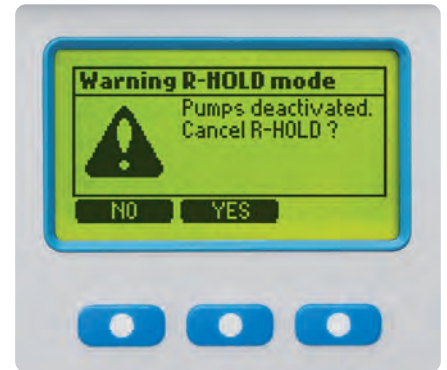

### R-HOLD (Remote Hold)

The reagent pumps can be turned off using the Remote Hold feature from Hanna Cloud. They can be reactivated at the controller or through Hanna Cloud.

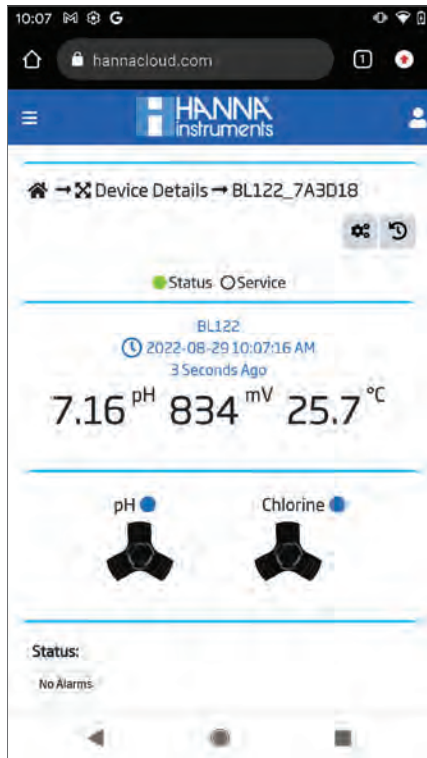

## Measurement

Measurement, alarm, hold and pump status are easily viewable.



## Notifications

Select which notifications you would like to receive.

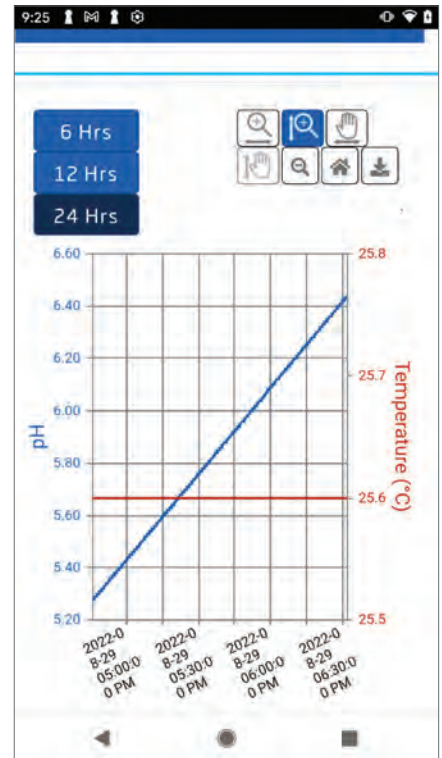

## Graphing

Use a graph to view trends over the last 12 hours or change the time period.

pH	ORP (mV)	Temperat
0.44	800	25
0.44	800	25
0.44	800	25
0.44	800	25
0.44	800	25
8.25	606	25
6.87	523	25
7.16	834	25
7.16	834	25
7.16	834	25

## Logging

Log history can be transferred as a PDF or .CSV.

Calibration Date	Offset (mV)	Slope (%)	Calibr.
2020-03-04 10:09:00 AM	130.0	100.1	2.41 p

## GLP

GLP data is readily available.

My Devices

Device Name: BL122\_7A3D18  
 Model No: BL122  
 Last Updated: 2022-08-29 10:24:06 AM  
 5 Seconds Ago

7.38<sup>pH</sup>  
 772<sup>mV</sup>  
 25.6<sup>°C</sup>

## Dashboard

View and add devices through the dashboard.



### Peristaltic Chemical Feed Pumps

BL122 and BL123 are equipped with two peristaltic dosing pumps with replaceable chemical resistant tubing that are proportionally controlled with adjustable flow rates. One of the pumps is used to dose acid or base while the other is used to dose chlorine. The effectiveness of the available chlorine, as determined by ORP, is inversely related to the water's pH value.

### Multicolored LED Indicators

BL122 and BL123 offers multiple LED indicators for status, servicing, and pump operation. The STATUS LED changes color based on operational state; a green LED means the water is within the desired parameter ranges, a yellow LED means that the controller needs attention, and a red LED identifies a problem in the system such as high and low pH, ORP and/or temperature readings. The SERVICE LED indicates attention is required by a service technician.

### Automatic Proportional Pump Control

BL122 and BL123 feature proportionally controlled dosing pumps. Based on the sensitivity of the process to chemical addition, these controllers allow the user to adjust a proportional band. This setting determines the amount of time that the pumps are dosing as a percentage of the deviation from the set point. For example, a large body of water will use a small proportional band; having a small band (e.g., 0.1 pH) will ensure the pumps are dosing more often when the reading is close to the set point. For smaller bodies of water such as hot tubs or spas, it is more useful to set a larger proportional band (e.g., 1.0 pH); when the reading is close to the set point, the amount of time that the dosing pump is on is minimal to avoid large swings of pH or ORP. This valuable feature allows for very fine control in maintaining the desired set point.

### Adjustable Flow Rate

The dosing pump flow rate is adjustable from 0.5 to 3.5L/h. Larger bodies of water require more chemical to be dosed than small bodies since it takes more chemical to see a change in the reading. The adjustable flow rate, like the proportional band, allows for better control in maintaining a desired set point.

### ORP (Chlorine) Dosing Consent

Both pH and ORP meters are commonly used with swimming pools. With chlorine disinfection there is an inverse relationship between pH and ORP. As the pH level increases, the ORP level decreases. These meters utilize a dosing consent feature that will not dose chlorine until the pH value is first corrected since it is possible to have a low ORP value even though there is sufficient chlorine. The dosing consent feature prevents waste of chemicals and avoids having a higher chlorine concentration level than desired.

### Acid and Chlorine Tank Level Inputs

The BL122 and BL123 allow for a connection to an optional level controller. This input is used to disable the dosing pumps when there is no chemical left in the reservoir tank.

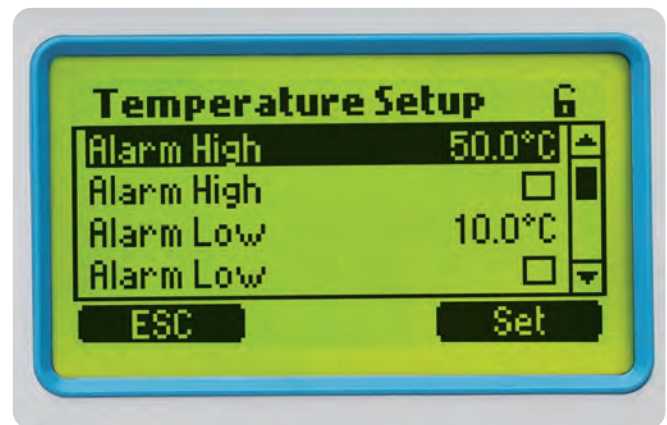

### Programmable Alarm System

These controllers allow users to enable or disable the low and high level of alarms for all parameters: pH, ORP, and temperature. When an alarm is activated, all dosing will stop. The alarm system also offers overdosing protection in that if the value is not corrected within a specified time interval then the meter will go into alarm status.

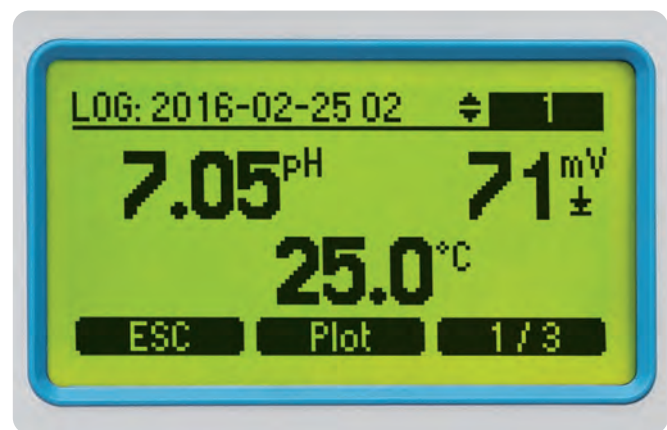

### Automatic Logging

The readings for each parameter are automatically logged every 10 seconds. A new log is started each time the instrument is calibrated or at the start of a new day. Logged data includes pH, ORP, and temperature values, last calibration data, setup configuration, and any event data.



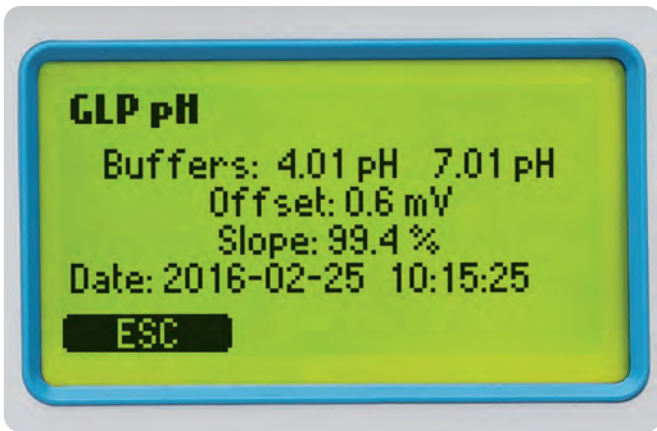

## GLP

Good Laboratory Practice (GLP) refers to a quality control function used to ensure uniformity of probe calibrations and measurements. GLP stores pH/ORP calibration information including date and time for pH/ORP sensors.

## Hold Input

It is possible to connect a flow switch mounted in-line or a mechanical relay that is connected to the recirculation pump power source to the hold input of these controllers. With no flow or when no power is applied to the recirculation pump, the hold circuit will disable the dosing pumps. This will prevent any dosing of chemical when there is no movement of water in the system.

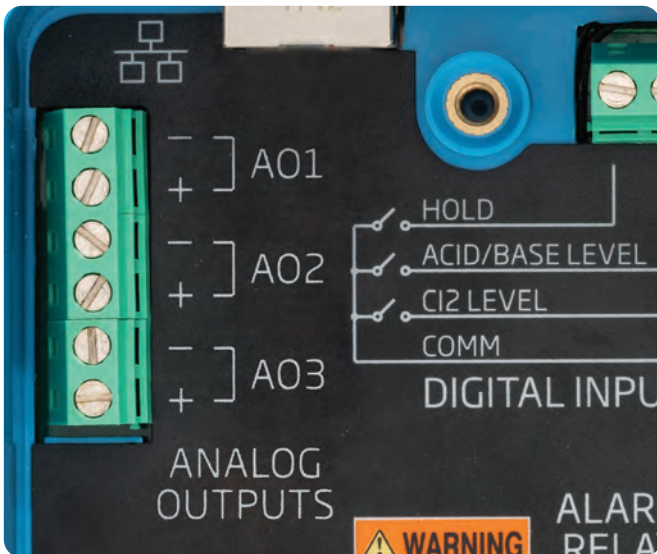

## BL123 Analog Outputs

The BL123 controller offers three 4-20 mA outputs. Each output can be disabled or connected to an external recording device. Each of the three measured parameters (pH, ORP, and temperature) can be assigned to an analog output where the current signal will be proportional to the measured value. For more flexibility and better resolution, the analog output can be scaled; users can define any two points within a parameter range to correspond to the analog output span. For example, the controller assigns 0 pH to 4 mA and 14 pH to 20 mA as a default. The user can adjust the pH range to assign pH 6 to 4 mA and pH 8 to 20 mA. This adjustment allows better resolution in the range of interest.



## USB Connectivity

For review and storage the users can easily transfer data to a PC using a flash drive and the USB port.

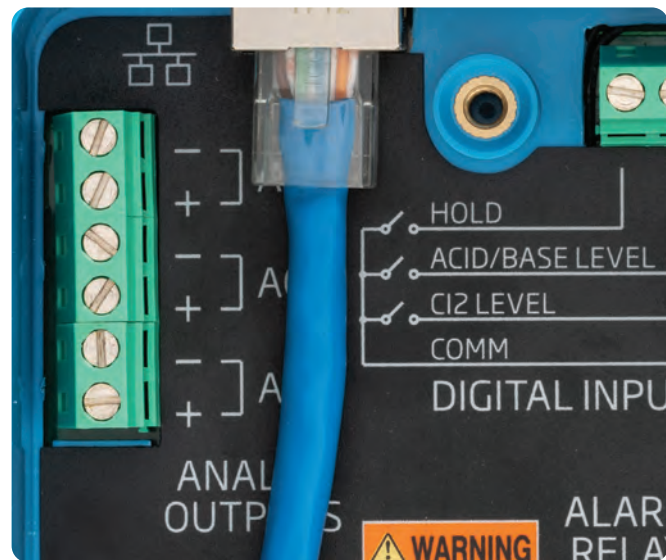

## Ethernet Port for Hanna Cloud Connectivity



## Password Protected

BL122 and BL123 controllers feature a password protection solution that offers restricted access to calibration, setup, and review of logged data. The password can be set and enabled/disabled during general setup of the instrument.

## Multiple Configurations

BL122 and BL123 swimming pool controllers are available in one of two configurations. The basic version is the in-line model which allows for direct installation of the probe and chemical injection fittings into existing piping.

A panel mounted version of these controllers with a bypass flow cell is also available. The bypass flow cell allows for calibration and maintenance of the probe without having to shut down the recirculation pump.



Flow Cell for  
BL122-20 and  
BL123-20



HI1036-1802

## Multiparameter Digital pH, ORP, Temperature Probe

The HI1036-1802 is a digital combined probe that measures pH, ORP, and temperature. This probe also incorporates a potential matching pin. The matching pin is considered the "earth ground" connection and is used to prevent ground loop effects from causing erratic readings and damage to the system.

The pH glass has been chosen to produce stable quick equilibration even in low conductivity waters. Additionally, the pH sensor is designed to produce a zero mV value near pH 4 (not pH 7 like typical pH sensors) that will stop the process control when the sensor is broken. A broken pH electrode that produces a mV value near pH 4 would produce an alarm state and disable any pump activated.

The ORP sensing surface is a large smooth surfaced platinum band that encircles the circumference of the temperature probe. It is referenced to Ag/AgCl reference electrode (3.5M KCl).

The ORP and pH sensors and reference electrode use a differential measurement technique which is known to stay in service and provide accurate measurements under adverse conditions that may cause conventional pH probes to produce erroneous measurements. The HI1036-1802 probe with its differential amplifiers greatly reduces inaccuracies caused by ground loops which may exist between process and instrument grounds. With the differential technique, a ground loop current will flow through the low impedance path of the matching pin thus providing immunity to the measurement signals. Additionally the probe converts these measurements to a digital signal to eliminate noise and static due to high impedance signals carried by cable.

The HI1036-1802 with the BL122 and BL123 pool controller helps to promote the health and safety of pool and spa water.



An all-in-one solution for automatic control of pH and chlorine levels in swimming pool, hot tub, and spa water.

Specifications	BL122/BL123	
pH	Range*	0.00 to 14.00 pH
	Resolution	0.01 pH
	Accuracy (@25°C/77°F)	±0.05 pH
	Calibration	pH buffer calibration: Automatic, two points (4.01, 7.01, 10.01 pH) pH process calibration: Single point, adjustable
pH Controller	proportional feed using adjustable set point and adjustable proportional band delay to start at power-on overdosing protection using overfeed safety timer	
mV	Range	±2000 mV
	Resolution	1 mV
	Accuracy (@25°C/77°F)	±5 mV
	ORP (mV) Calibration	single point, adjustable
ORP Controller	proportional feed using adjustable set point and adjustable proportional band delay to start at power-on overdosing protection using overfeed safety timer pH regulator interlocked	
Temperature	Range*	-5.0 to 105.0 °C (23.0 to 221.0 °F)
	Resolution	0.1 °C (0.1 °F)
	Accuracy (@25°C/77°F)	±1 °C (±1.8 °F)
	Temperature Compensation	automatic -5.0 to 105.0 °C (23.0 to 221.0 °F) for pH
Alarms	high and Low with enable / disable option for all parameters alarm is triggered after five consecutive readings over / under threshold	
Additional Specifications	automatic log 60 days logging with 10 seconds period (or 100 logs) pH / ORP / temperature measurements events: alarms / errors / power outage recall table/graphic modes export on USB key log files in CSV format	
Log Feature		

\*range limited by probe.

	<p>BL122 and BL123 devices are connected to Hanna Cloud using a secured connection.</p> <ul style="list-style-type: none"> <li>• ethernet (RJ45) 10/100 Mbps connection</li> <li>• device Identity Registry</li> <li>• policy-based authorization of security keys</li> </ul> <p>The instrument will send status information to Hanna Cloud with a defined period.</p> <ul style="list-style-type: none"> <li>• readings: pH, ORP, temperature</li> <li>• events: alarms/warnings/errors</li> <li>• peripheral status: LEDs</li> <li>• last dosed acid and chlorine volumes</li> <li>• GLP info</li> </ul>
Cloud Connectivity	<p>The instrument will send setup information to Hanna Cloud at startup and whenever the setup is changed on the instrument.</p> <ul style="list-style-type: none"> <li>• alarm settings</li> <li>• dosing settings</li> <li>• general settings</li> <li>• system: meter information (model, FW version, OS version, serial number), probe information (type, FW version, serial number)</li> </ul> <p>The BL122 and BL123 "Remote Hold" mode:</p> <ul style="list-style-type: none"> <li>• is an emergency mode that can be remotely triggered via web application</li> <li>• in this mode the pumps are deactivated</li> <li>• can be canceled manually from the controller menu</li> </ul>

Ethernet Input	ethernet connector (RJ-45) 10/100 Mbps connection
Pump Control	pump flow control 0.5 to 3.5 L/h (0.13 to 0.92 G/hour) and maximum output pressure 1 atm (14 psi) manual control for each pump
Password Protection	setup, calibration and log recall features are password protected
Storage Interface	USB
GLP	pH/ORP
Alarm System	Intuitive alert system based on LED color coded alarm system Alarm filtering options Alarm relay control based on user setup filters
Alarm Relay Output (1)	SPDT 5A/230 VAC Activated by selectable pH / ORP / Temperature alarm conditions
Analog Outputs (3) (BL123 only)	three configurable analog outputs, 4 to 20 mA, sourcing output impedance $\leq 500 \Omega$ accuracy $< 0.5\%$ FS galvanic isolation, up to 50 V relative to earth
Digital Inputs (3)	galvanic isolated, powered contact type one input for low level in acid / base tank (contact open) one input for low level in chlorine tank (contact open) one input for Hold mode (contact open)
Probe Input (1)	probe type: HI1036-18XX pH / ORP / Temperature / Matching pin, combined digital probe DIN waterproof connector galvanic isolation RS485 interface
Power Supply	100–240 VAC
Power Consumption	15 VA
Environment	0 to 50°C (32-122°F); max 95% RH non-condensing
Dimensions	245 x 188 x 55 mm (73 mm with pumps); 9.6 x 7.4 x 2.2" (2.9" with pumps)
Weight	1700 g (60 oz.)
Casing	Wall mounted, built-in pump, IP65 rated

#### In-Line Configuration:

**BL122-10** and **BL123-10** (analog outputs) pH/ORP/temperature pool controller is supplied with HI1036-1802 pH/ORP/temperature digital probe with matching pin, saddle for electrode 50 mm (1), fittings for electrode Injector (2), saddle for injectors 50 mm (2), peristaltic pump tubing (2), aspiration (5 m) and injection (5 m) tubing, aspiration filter (2), pH 7.01 buffer sachets, 20 ml (3), pH 4.01 buffer sachets, 20 ml (3), 470 mV ORP test solution sachet, 20 ml (3), power cable, user manual, and quality certificates for meter and probe.

Ordering  
Information

#### User Panel Flow Cell Configuration:

**BL122-20** and **BL123-20** (analog outputs) pH/ORP/Temperature pool controller is supplied with HI1036-1802 pH/ORP/temperature digital probe with matching pin, two valves for flow-cell connections with fittings and tubing 10 m, saddle for valves 50 mm (2), saddle for electrode 50 mm (1), fittings for electrode Injector (2), saddle for injectors 50 mm (2), peristaltic pump tubing (2), aspiration (5 m) and injection (5 m) tubing, aspiration filter (2), pH 7.01 buffer sachets, 20 ml (3), pH 4.01 buffer sachets, 20 ml (3), 470 mV ORP test solution sachet, 20 ml (3), power cable, user manual, and quality certificates for meter and probe.



**BL120-450**  
Flow-cell kit for 50 mm pipe diameter



**BL120-463**  
Flow-cell kit for 63 mm pipe diameter



**BL120-475**  
Flow-cell kit for 75 mm pipe diameter



**BL120-150**  
Fittings Kit for 50 mm pipe diameter.



**BL120-163**  
Fittings Kit for 63 mm pipe diameter



**BL120-175**  
Fittings Kit for 75 mm pipe diameter



**BL120-263**  
Injector saddle for 63 mm pipe diameter, 1/2" thread



**BL120-250**  
Injector saddle for 50 mm pipe diameter, 1/2" thread



**BL120-275**  
Injector saddle for 75 mm pipe diameter, 1/2" thread



**BL120-550**  
Probe saddle for 50 mm pipe diameter, 1 1/4" thread



**BL120-563**  
Probe saddle for 63 mm pipe diameter, 1 1/4" thread



**BL120-575**  
Probe saddle for 75 mm pipe diameter, 1 1/4" thread



**BL120-200**  
Pool Controller aspiration filter



**BL120-201**  
Pool Controller injector, 1/2" thread



**BL120-903**  
Cable gland protective kit (6 pcs.)



**BL120-402**  
Flow-cell tubing (10 m)



**BL120-202**  
Aspiration and dispersion tubing (10 m)



**BL120-300**  
Pool Controller peristaltic pump tubing kit (2 pcs.)



**BL120-410**  
Flow cell



**BL120-401**  
Flow-cell valve



**BL120-400**  
Flow-cell probe adapter kit



**BL120-603**  
Elbow for glass flow cell



**BL120-604**  
O-ring for glass flow cell



**BL120-301**  
Pool controller peristaltic pump rotor



**BL120-501**  
Protective saddle cap, 1 - 1/4" thread



**BL120-602**  
Metal nipple 12 x 1/2" (2 pcs.)



**BL120-601**  
Plastic nipple 2 x 1/2" with O-rings



**BL120-500**  
Probe fitting kit



**BL120-901**  
Simulator for BL121



**BL123-70**  
Calibration and Maintenance Kit  
1 x pH 7.01 buffer solution sachet (20 mL)  
1 x pH 4.01 buffer solution sachet (20 mL)  
1 x electrode cleaning solution sachet (20 mL)  
1 x electrode storage solution sachet (20 mL)  
1 x ORP test solution sachet (20 mL)

**BL123-70-30**  
30 x BL123-70 Calibration and Maintenance Kit



**BL120-902**  
USB protective cap



**BL120-302**  
Pool controller pump cover with screw



**BL120-411**  
Flow cell panel spare part



BL120 and BL121

## pH/ORP Controllers

*with Built-In Chemical Feed Pumps*

The BL120 and BL121 Swimming Pool Controller is a complete system designed for maintaining swimming pool, hot tub, and spa disinfection water quality. These controllers are available in two configurations. The basic version is the in-line model which allows for direct installation of probe and chemical injection fittings into existing piping. A panel mounted version with a bypass flow cell is also available. The bypass flow cell allows for calibration and maintenance of the probe without having to shut down the recirculation pump.

The BL120 and BL121 use a multiparameter digital HI1036-1802 probe that incorporates pH, ORP, and temperature sensors along with a matching pin. All readings are measured within the probe and the data transferred to the controller by a digital connection. Both a digital connection and matching pin provide for stable, reliable measurements. Without these two components, electrical noise from recirculation pumps and ground loops can interfere, causing erratic readings and premature probe failure.

These controllers have two built-in peristaltic chemical feed pumps that are proportionally controlled with adjustable flow rates. One of the pumps is used to dose acid while the other is used to dose chlorine. The effectiveness of the available chlorine, as determined by ORP, is inversely related to the water's pH value. A pool with a fixed concentration of chlorine will show a decrease in

ORP as the pH of the water increases. The BL120 and BL121 utilize a dosing consent feature that will not dose chlorine until the pH value is first corrected, since it is possible to have a low ORP value even though there is sufficient chlorine. The dosing consent feature will prevent chemical wastage and having a higher chlorine concentration level than desired.

For compliance monitoring, BL120 and BL121 have a built-in datalogger. Measurement readings are logged every 10 seconds with a new log starting for each new day or when the instrument is calibrated. Logged data include pH, ORP, and temperature values, last calibration data, setup configuration, and any event data.

For BL121 models, three 4-20 mA analog outputs are available for users that wish to connect to an external chart recorder or datalogger to monitor any of the three measured parameters. The outputs are scalable, offering increased flexibility and better resolution as needed.

Additional features of the BL121 include LED indicators for dosing, meter status and service, real-time graph display, programmable alarms, and password protection.

These controllers are an all-in-one solution for automatic control of pH and chlorine levels in swimming pool, hot tub, and spa water.

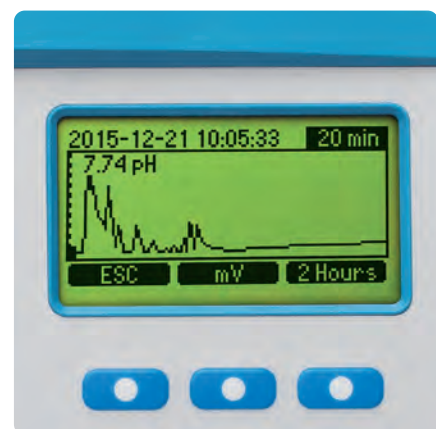
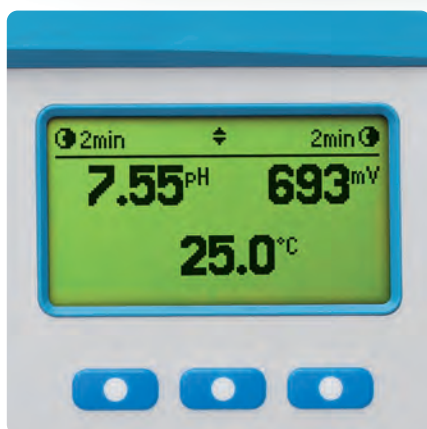

### Three Display Modes

The versatile display of the BL120 and BL121 allows for three display modes. The LCD can display all three parameters at one time, a 3-second cycle of single parameters, or a real-time plot screen with options for parameter selection, zooming, and log recall.



### Peristaltic Dosing Pumps

BL120 and BL121 are equipped with two peristaltic dosing pumps with replaceable chemical resistant tubing. A problem that occurs with chlorine dosing pumps is the formation of chlorine gas. When using a diaphragm pump, chlorine gas can collect in the pump head and cause the pump to lose prime; the buildup of chlorine gas is not a problem with peristaltic pumps that use rollers and tubing.

### Automatic Proportional Pump Control

BL120 and BL121 feature proportionally controlled dosing pumps. Based on the sensitivity of the process to chemical addition, these controllers allow the user to adjust a proportional band. This setting determines the amount of time that the pumps are dosing as a percentage of the deviation from the set point. For example, a large body of water will use a small proportional band; having a small band (e.g., 0.1 pH) will ensure the pumps are dosing more often when the reading is close to the set point. For smaller bodies of water such as hot tubs or spas, it is more useful to set a larger proportional band (e.g., 1.0 pH); when the reading is close to the set point, the amount of time that the dosing pump is on is minimal to avoid large swings of pH or ORP. This valuable feature allows for very fine control in maintaining the desired set point.

### Adjustable Flow Rate

The flow rate from the dosing pumps is adjustable from 0.5 to 3.5L/h. Larger bodies of water require more chemical to be dosed than small bodies since it takes more chemical to change the the reading. The adjustable flow rate, like the proportional band, allows for better control in maintaining a desired set point.

### ORP (Chlorine) Dosing Consent

Both pH and ORP meters are commonly used with swimming pools. With chlorine disinfection there is an inverse relationship between pH and ORP. As the pH level increases, the ORP level decreases. The BL120 and BL121 utilize a dosing consent feature that will not dose chlorine until the pH value is first corrected since it is possible to have a low ORP value even though there is sufficient chlorine. The dosing consent feature prevents wastage of chemicals and avoids a higher than necessary chlorine concentration.

### Acid and Chlorine Tank Level Inputs

The BL120 and BL121 allow for a connection to an optional level controller. This input is used to disable the dosing pumps when there is no chemical left in the corresponding reservoir tank.

### Hold Input

It is possible to connect a flow switch mounted in-line or a mechanical relay that is connected to the recirculation pump power source to the hold input of these controllers. With no flow or when no power is applied to the recirculation pump, the hold circuit will disable the dosing pumps. This will prevent any dosing of chemical when there is no movement of water in the system.

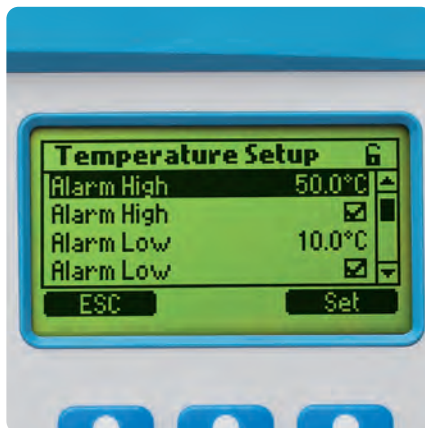

### Programmable Alarm System

These controllers allow users to enable or disable the low and high level of alarms for all parameters: pH, ORP, and temperature. When an alarm is activated, all dosing will stop. The alarm system also offers overdosing protection in that if the value is not corrected within a specified time interval then the meter will go into alarm status.



### Multicolored LED Indicators

BL120 and BL121 offers multiple LED indicators for status, servicing, and pump operation. The STATUS LED changes color based on operational state; a green LED means the water is within the desired parameter ranges, a yellow LED means that the controller needs attention, and a red LED identifies a problem in the system such as high and low pH, ORP and/or temperature readings. The SERVICE LED indicates any alarms and process errors experienced by the controller.



### BL121 Analog Outputs

The BL121 controller offers three 4-20 mA outputs. Each output can be disabled or connected to an external recording device. Each of the three measured parameters (pH, ORP, and temperature) can be assigned to an analog output where the current signal will be proportional to the measured value. For more flexibility and better resolution, the analog output can be scaled; users can define any two points within a parameter range to correspond to the analog output span. For example, the controller assigns 0 pH to 4 mA and 14 pH to 20 mA as a default. The user can adjust the pH range to assign pH 6 to 4 mA and pH 8 to 20 mA. This adjustment allows better resolution in the range of interest.



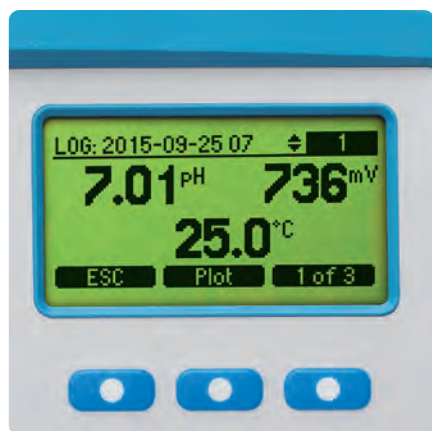

### Automatic Logging

The readings for each parameter are automatically logged every 10 seconds. A new log is started each time the instrument is calibrated or at the start of a new day. Logged data include pH, ORP, and temperature values, last calibration data, setup configuration, and any event data.



### USB Connectivity

For review and storage the users can easily transfer data to a PC using a flash drive and the USB port.



### Password Protected

BL120 and BL121 controllers feature a password protection solution that offers restricted access to calibration, setup, and review of logged data. The password can be set and enabled/disabled during general setup of the instrument.



Flow Cell for  
BL120-20 and  
BL121-20

### Multiple Configurations

BL120 and BL121 swimming pool controllers are available in one of two configurations. The basic version is the in-line model which allows for direct installation of the probe and chemical injection fittings into existing piping.

A panel mounted version of these controllers with a bypass flow cell is also available. The bypass flow cell allows for calibration and maintenance of the probe without having to shut down the recirculation pump.

### HI1036-1802

## Multiparameter Digital pH, ORP, Temperature Probe

The HI1036-1802 is a digital combined probe that measures pH, ORP, and temperature. This probe also incorporates a potential matching pin. The matching pin is considered the "earth ground" connection and is used to prevent ground loop effects from causing erratic readings and damage to the system.

The pH glass has been chosen to produce stable quick equilibration even in low conductivity waters. Additionally, the pH sensor is designed to produce a mV value near pH 4 (not pH 7 like typical pH sensors) should it stop working. A broken pH electrode that produces a mV value near pH 7 would produce an alarm state and disable any pump activated.

The ORP sensing surface is a large smooth surfaced platinum band that encircles the circumference of the temperature probe. It is referenced to Ag/AgCl reference electrode (3.5M KCl).

The ORP and pH sensors and reference electrode use a differential measurement technique which is known to stay in service and provide accurate measurements under adverse conditions that may cause conventional pH probes to produce erroneous measurements. The HI1036-1802 probe with its differential amplifiers greatly reduces inaccuracies caused by ground loops which may exist between process and instrument grounds. With the differential technique, a ground loop current will flow through the low impedance path of the matching pin thus providing immunity to the measurement signals. Additionally the probe converts these measurements to a digital signal to eliminate noise and static due to high impedance signals carried by cable.

The HI1036-1802 with the BL120 or BL121 pool controller helps to promote the health and safety of pool and spa water.

Specifications	BL120/BL121	
pH	Range*	0.00 to 14.00 pH
	Resolution	0.01 pH
	Accuracy (@25°C/77°F)	±0.05 pH
	Calibration	pH buffer calibration: Automatic, two points (4.01, 7.01, 10.01 pH) pH process calibration: Single point, adjustable
pH Controller	proportional feed using adjustable set point and adjustable proportional band delay to start at power-on overdosing protection using overfeed safety timer	
mV	Range	±2000 mV
	Resolution	1 mV
	Accuracy (@25°C/77°F)	±5 mV
	ORP (mV) Calibration	single point, adjustable
ORP Controller	proportional feed using adjustable set point and adjustable proportional band delay to start at power-on overdosing protection using overfeed safety timer pH regulator interlocked	
Temperature	Range*	-5.0 to 105.0 °C (23.0 to 221.0 °F)
	Resolution	0.1 °C (0.1 °F)
	Accuracy (@25°C/77°F)	±1 °C (±1.8 °F)
	Temperature Compensation	automatic -5.0 to 105.0 °C (23.0 to 221.0 °F) for pH
Alarms	high and Low with enable / disable option for all parameters alarm is triggered after five consecutive readings over / under threshold	
Log Feature	automatic log 60 days logging with 10 seconds period (or 100 logs) pH / ORP / temperature measurements events: alarms / errors / power outage recall table/graphic modes export on USB key log files in CSV format	
Additional Specifications	Ethernet Input	ethernet connector (RJ-45) 10/100 Mbps connection
	Pump Control	pump flow control 0.5 to 3.5 L/h (0.13 to 0.92 G/hour) and maximum output pressure 1 atm (14 psi) manual control for each pump
	Password Protection	setup, calibration and log recall features are password protected
	Storage Interface	USB
	GLP	pH/ORP
	Alarm System	Intuitive alert system based on LED color coded alarm system Alarm filtering options Alarm relay control based on user setup filters
	Alarm Relay Output (1)	SPDT 5A/230 VAC Activated by selectable pH / ORP / Temperature alarm conditions
Additional Specifications	Analog Outputs (3) (BL121 only)	three configurable analog outputs, 4 to 20 mA, sourcing output impedance ≤ 500 Ω accuracy < 0.5 % FS galvanic isolation, up to 50 V relative to earth
	Digital Inputs (3)	galvanic isolated, powered contact type one input for low level in acid / base tank (contact open) one input for low level in chlorine tank (contact open) one input for Hold mode (contact open)
	Probe Input (1)	probe type: HI1036-18XX pH / ORP / Temperature / Matching pin, combined digital probe DIN waterproof connector galvanic isolation RS485 interface
	Power Supply	100–240 VAC
Power Consumption	15 VA	
Environment	0 to 50 °C (32-122 °F); max 95% RH non-condensing	
Dimensions	245 x 188 x 55 mm (73 mm with pumps); 9.6 x 7.4 x 2.2" (2.9" with pumps)	
Weight	1700 g (60 oz.)	
Casing	Wall mounted, built-in pump, IP65 rated	

#### In-Line Configuration

**BL120-10** and **BL121-10** (analog outputs) pH/ORP/Temperature Pool Controllers are supplied with HI1036-1802 pH/ORP/temperature digital probe with matching pin, 50 mm probe saddle (1), fitting for probe, chemical injectors (2), 50 mm saddle for injectors (2), peristaltic tubing (2), 5 m of injection tubing, aspiration filter (2), pH 7.01 buffer sachets, 20mL (3), pH 4.01 buffer sachets, 20mL (3), 470 mV test solution sachets (3), power cable and instruction manual.

#### User Panel Flow Cell Configuration

**BL120-20** and **BL121-20** (analog outputs) pH/ORP/temperature pool controllers with flow cell are supplied with panel mounted flow cell, HI1036-1802 pH/ORP/temperature digital probe with matching pin, 50 mm probe saddle (1), fitting for probe, chemical injectors (2), 50 mm saddle for injectors (2), peristaltic tubing (2), 5 m of injection tubing, aspiration filter (2), pH 7.01 buffer sachets, 20mL (3), pH 4.01 buffer sachets, 20mL (3), 470 mV test solution sachets (3), power cable and instruction manual.

Ordering Information

\*range limited by probe.



**BL120-450**  
Flow-cell kit for 50 mm pipe diameter



**BL120-463**  
Flow-cell kit for 63 mm pipe diameter



**BL120-475**  
Flow-cell kit for 75 mm pipe diameter



**BL120-150**  
Fittings Kit for 50 mm pipe diameter.



**BL120-163**  
Fittings Kit for 63 mm pipe diameter



**BL120-175**  
Fittings Kit for 75 mm pipe diameter



**BL120-263**  
Injector saddle for 63 mm pipe diameter, 1/2" thread



**BL120-250**  
Injector saddle for 50 mm pipe diameter, 1/2" thread



**BL120-275**  
Injector saddle for 75 mm pipe diameter, 1/2" thread



**BL120-550**  
Probe saddle for 50 mm pipe diameter, 1 1/4" thread



**BL120-563**  
Probe saddle for 63 mm pipe diameter, 1 1/4" thread



**BL120-575**  
Probe saddle for 75 mm pipe diameter, 1 1/4" thread



**BL120-200**  
Pool Controller aspiration filter



**BL120-201**  
Pool Controller injector, 1/2" thread



**BL120-903**  
Cable gland protective kit (6 pcs.)



**BL120-402**  
Flow-cell tubing (10 m)



**BL120-202**  
Aspiration and dispersion tubing (10 m)



**BL120-300**  
Pool Controller peristaltic pump tubing kit (2 pcs.)



**BL120-410**  
Flow cell



**BL120-401**  
Flow-cell valve



**BL120-203**  
Aspiration filter weight for BL12X pH/ORP/temperature pool controllers

**BL120-400**  
Flow-cell probe adapter kit

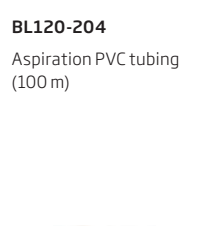

**BL120-204**  
Aspiration PVC tubing (100 m)

**BL120-603**  
Elbow for glass flow cell

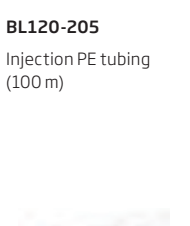

**BL120-205**  
Injection PE tubing (100 m)

**BL120-604**  
O-ring for glass flow cell



**BL120-605**  
Metal Nipple 12X1/4 for BL120-410 Flowcell

**BL120-301**  
Pool controller peristaltic pump rotor



**BL120-501**  
Protective saddle cap, 1 - 1/4" thread



**BL120-602**  
Metal nipple 12 x 1/2" (2 pcs.)



**BL120-601**  
Plastic nipple 2 x 1/2" with O-rings



**BL120-500**  
Probe fitting kit



**BL120-901**  
Simulator for BL121



**BL120-302**  
Pool controller pump cover with screw



**BL123-70**  
Calibration and Maintenance Kit  
1 x pH 7.01 buffer solution sachet (20 mL)  
1 x pH 4.01 buffer solution sachet (20 mL)  
1 x electrode cleaning solution sachet (20 mL)  
1 x electrode storage solution sachet (20 mL)  
1 x ORP test solution sachet (20 mL)

**BL123-70-30**  
30 x BL123-70 Calibration and Maintenance Kit



**BL120-902**  
USB protective cap



**BL120-411**  
Flow cell panel spare part

HI981412

## pH Dosing System

for Nutrient Solutions and Irrigation Water

HI981412 pH Dosing System is engineered for maintaining the pH of nutrient solutions and irrigation water. The pH of nutrient solution or irrigation water is critical for the successful propagation and growth of plants. Macro and micro nutrients as well as calcium and magnesium bloom boosters require the correct pH for absorption into the plants root system. The HI981412 was developed to be an inexpensive solution for the horticulturist to maintain the ideal pH at all times. Simply insert the probe and injection valve in-line with the recirculation pump and provide the chemical to be dosed.

*HI981412 is available in multiple configurations including a meter and probe option, a kit for in-line mounting, and a complete package that includes bypass loop and panel mounted flow cell. The kit for in-line and flow cell models include aspiration tubing with filter and dispensing tubing with injection valve.*



HI10063 Amplified pH/Temperature Probe



## Features



### Peristaltic Dosing Pump

The HI981412 has a powerful built-in peristaltic chemical feed pump that utilizes a stepper motor which does not have any gears or brushes to wear out. This design provides for a long life and little maintenance.



### Quick Connect Probe Input

The Quick Connect DIN connector creates a waterproof seal with the controller making it ideal for reducing electrical noise issues with the connection caused by humid environments.



### Acid Tank Level/Flow Switch Input

The HI981412 allows for a connection to an optional level controller or flow switch. This input can be used to disable the dosing pump when there is no chemical left in the reservoir tank or there is no flow due to the pump being turned off.



### Adjustable Flow Rate

The flow rate from the dosing pumps is adjustable from 0.5 to 3.5L/h. Larger bodies of water require more chemical to be dosed than smaller ones in per unit of time. The adjustable flow rate, like the proportional band, allows for better control in maintaining a desired set point.



### Automatic Proportional Pump Control

The peristaltic dosing pump can be controlled by simple on/off or more advanced proportional control which helps prevent overshooting of the set point. When using proportional control the flow rate that is programmed, will be impacted by the proportional band used. The closer the reading is to the set point the longer it takes for the peristaltic pump to complete one revolution. If the reading is outside the proportional band then the amount of time it takes to complete one revolution is based on the flow rate programmed.



### Programmable Alarm System

Enables or disables the low and high-level alarms for pH. When an alarm is activated, all dosing will stop. For added safety, the alarm system also offers overdosing protection in that if the set point value is not corrected within a programmed time interval then the meter will go into alarm status.



For example, a controller is programmed to have a set point of pH 6.80 with a 1.00 pH unit proportional band and the flow rate at 1.0 L/h. Any reading above pH 7.80 will cause the dosing of acid to be at 1.0 L/h. If the reading is at pH 7.30, which is 1/2 of the band, then the dosing pump will run at half speed or deliver 0.5 L/h of chemical. The closer the reading is to the set point the longer it takes for the pump to complete one rotation. This allows for very fine control of the pH value desired.



### Multicolored LCD Display

The HI981412 features a multi-colored LCD that provides for a quick way to see the status of the controller. If in control mode and operating as intended the display will be green. If control is not enabled then the display will be yellow; while in an alarm state the display flashes red.

## HI10063 Amplified pH/Temperature Probe

The HI981412 uses the HI10063 amplified probe that incorporates both pH and temperature sensors and connects to the controller with a single waterproof Quick Connect DIN connector. The built in amplifier helps to reduce electrical noise from recirculation pumps to provide for a stable, reliable measurement. The pH glass used is ideal for low conductivity water and provides for fast response. The PVDF body of the probe has a 1/2" threaded fitting for insertion to an in-line "T" fitting or the flow cell. The back end part of the probe has 3/4" NPT threads for submersion/tank mounting. The probe body has a hex fitting for tightening snugly with a wrench.



Specifications	HI981412	
pH	Range*	0.00 to 14.00 pH
	Resolution	0.01 pH
	Accuracy (@25°C/77°F)	±0.10 pH
	Calibration	user calibration: automatic, one or two-point with buffer solution (4.01, 7.01, 10.01 pH) Process calibration: single point, adjustable (±0.50 pH around measured pH)
Temperature	Range*	-5.0 to 105.0°C (23.0 to 221.0°F)
	Resolution	0.1°C (0.1°F)
	Accuracy (@25°C/77°F)	±0.5°C (±0.9°F)
	Temperature Compensation	automatic
Dosing Control Type		On/Off control using adjustable set point (4.00 to 10.00 pH) with adjustable hysteresis (0.10 to 1.00 pH)
		proportional control using adjustable set point (4.00 to 10.00 pH) with adjustable proportional band (0.10 to 2.00 pH)
Dosing Control Activation		high or low mode operation
		high set point dosing is activated when reading is higher than set point (dose acid) Low set point dosing is activated when reading is lower than set point (dose base)
Delay Start for Dosing		startup delay timer at power-on (0 to 600 sec.)
Maximum Dosing Time		overfeed protection using overtime safety timer (1 to 180 min. or Off)
Pump Flow Control		selectable flow rate (0.5 to 3.5 L / hour; 0.13 to 0.92 G/hour) manual control for pump priming
Additional Specifications	Alarms	high and low with enable / disable option triggered after 5 sec. if controller records a set of consecutive readings over / under threshold values level with enable / disable option overtime protection (1 to 180 min. or off) Intuitive alarm system, using red-yellow-green color-coded backlight
	Alarm Relay Output (1)	SPDT 2.5A / 230 VAC
External Event Input		input for level controller or flow switch to disable dosing pump in the event of no chemical when using a level controller or no flow when using a flow switch - galvanically isolated
Probe Input (1)		HI10063 amplified pH/Temperature probe with quick connect DIN connector - galvanically isolated
Power Supply		100–240 VAC, 50/60 Hz
Power Consumption		15 VA
Environment		0–50°C (32–122°F), max. 95% RH non-condensing
Dimensions		90 x 142 x 80 mm (3.5 x 5.6 x 1.8")
Weight		910 g (32 oz)
Casing		wall mounted, built-in pump, IP65 rated

### Ordering Information

**HI981412-00** is supplied with HI981412 controller, HI10063 pH/temperature probe, 4.01 pH buffer solution, 20 mL (3), 7.01 pH buffer solution, 20 mL (3), power connection cable, instruction manual and quality certificates for instrument and probe.

**HI981412-10** (with in-line mounting kit) is supplied with HI981412 controller, HI10063 pH/temperature probe, controller aspiration filter, controller injector, 1/2" thread, saddle for Ø 50 mm pipe (2), PVC aspiration tubing (flexible) (5 m), PE rigid dispensing tubing (5 m), 4.01 pH buffer solution, 20 mL (3), 7.01 pH buffer solution, 20 mL (3), power connection cable, instruction manual and quality certificates for instrument and probe.

**HI981412-20** (with flow-cell mounting kit) is supplied with HI981412 controller, HI10063 pH/temperature probe, flow cell for HI981412, mounting panel assembly for HI981412, controller aspiration filter, controller injector, 1/2" thread, saddle for Ø 50 mm pipe (3), PVC aspiration tubing (flexible) (5 m), PE rigid dispensing tubing (15 m), barbed tubing adapter 1/2" - 6 mm with racord (2), valves (2), 4.01 pH buffer solution, 20 mL (3), 7.01 pH buffer solution, 20 mL (3), power connection cable, instruction manual and quality certificates for instrument and probe.

\*range limited by probe.



**BL120-410**  
Flow cell



**BL120-450**  
Flow-cell kit for 50 mm pipe diameter



**BL120-463**  
Flow-cell kit for 63 mm pipe diameter



**BL120-475**  
Flow-cell kit for 75 mm pipe diameter



**BL100-421**  
Flow cell panel

**BL100-400**  
Probe adapter kit (contains adapter, fixing nut, O-ring)



**BL120-263**  
Injector saddle for 63 mm pipe diameter, 1/2" thread



**BL120-250**  
Injector saddle for 50 mm pipe diameter, 1/2" thread



**BL120-275**  
Injector saddle for 75 mm pipe diameter, 1/2" thread



**BL120-401**  
Flow-cell valve



**BL120-201**  
Pool Controller injector, 1/2" thread



**BL120-200**  
Pool Controller aspiration filter



**BL100-300**  
Pool Controller peristaltic pump tubing kit (2 pcs.)



**BL120-202**  
Aspiration and dispersion tubing (10 m)



**BL120-301**  
Peristaltic pump rotor



**HI740036P**  
Plastic beaker set, 100 mL (10 pcs.)



**HI10063**  
pH/temperature probe with 2 m cable, DIN Quick connect



**BL100-302**  
Pump cover with screw



**HI70004G**  
pH 4.01 buffer sachet (GroLine®), 20 mL (25 pcs.)



**HI7004-012**  
pH 4.01 buffer solution (GroLine), 120 mL



**HI7007-012**  
pH 7.01 buffer solution (GroLine), 120 mL



**HI7010-012**  
pH 10.01 buffer solution (GroLine), 120 mL



**HI70061G**  
General cleaning solution (GroLine), 20 mL (25 pcs.)



**HI70300G**  
Storage solution (GroLine), 20 mL (25 pcs.)

**HI70007G**  
pH 7.01 buffer sachet (GroLine), 20 mL (25 pcs.)

**HI7004-023**  
pH 4.01 buffer solution (GroLine), 230 mL

**HI7007-023**  
pH 7.01 buffer solution (GroLine), 230 mL

**HI7010-023**  
pH 10.01 buffer solution (GroLine), 230 mL

**HI7061-012**  
General cleaning solution (GroLine), 120 mL

**HI70300-012**  
Storage solution (GroLine), 120 mL

**HI70010G**  
pH 10.01 buffer sachet (GroLine), 20 mL (25 pcs.)

**HI7004-050**  
pH 4.01 buffer solution (GroLine), 500 mL

**HI7007-050**  
pH 7.01 buffer solution (GroLine), 500 mL

**HI7010-050**  
pH 10.01 buffer solution (GroLine), 500 mL

**HI7061-023**  
General cleaning solution (GroLine), 230 mL

**HI70300-023**  
Storage solution (GroLine), 230 mL

**HI7061-050**  
General cleaning solution (GroLine), 500 mL

**HI70300-050**  
Storage solution (GroLine), 500 mL

HI981413

## Nutrient Dosing System

for Nutrient Solutions and Irrigation Water

HI981413 Nutrient Dosing System is engineered for maintaining the concentration of fertilizer in the nutrient solution used in hydroponics and irrigation water. The nutrient concentration in the water used for irrigation is critical for the successful propagation and growth of plants. The HI981413 uses an amperometric conductivity sensor for measuring the amount of fertilizer in the solution. The meter can be programmed to display results as EC (electrical conductivity) or as TDS (total dissolved solids). The EC results are displayed as mS/cm while TDS is displayed as ppm with a selectable conversion factor from 0.45 to 0.99. The HI981413 was developed to be an inexpensive solution for the horticulturist to maintain the ideal fertilizer concentrations at all times. Simply insert the probe and injection valve in-line with the recirculation pump and provide the chemical to be dosed.

*HI981413 is available in multiple configurations including a meter and probe option, a kit for in-line mounting, and a complete package that includes bypass loop and panel mounted flow cell. The kit for in-line and flow cell models include aspiration tubing with filter and dispensing tubing with injection valve.*



HI30033 EC/Temperature Probe





## Features



### Peristaltic Dosing Pump

The HI981413 has a powerful built-in peristaltic chemical feed pump that utilizes a stepper motor which does not have any gears or brushes to wear out. This design provides for a long life and little maintenance.



### Quick Connect Probe Input

The Quick Connect DIN connector creates a waterproof seal with the controller making it ideal for reducing electrical noise issues with the connection caused by humid environments.



### Nutrient Level/Flow Switch Input

The HI981413 allows for a connection to an optional level controller or flow switch. This input can be used to disable the dosing pump when there is no chemical left in the reservoir tank or there is no flow due to the pump being turned off.

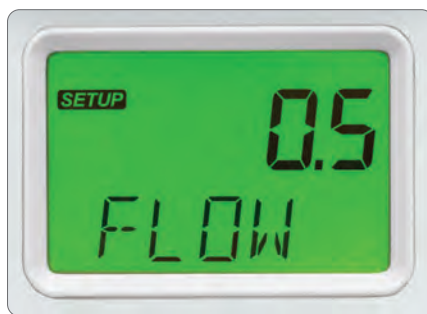

### Adjustable Flow Rate

The flow rate from the dosing pumps is adjustable from 0.5 to 3.5L/h. Larger bodies of water require more chemical to be dosed than smaller ones in per unit of time. The adjustable flow rate, like the proportional band, allows for better control in maintaining a desired set point.



### Programmable Alarm System

Enables or disables the low and high-level alarms. When an alarm is activated, all dosing will stop. For added safety, the alarm system also offers overdosing protection in that if the set point value is not corrected within a programmed time interval then the meter will go into alarm status.



### Multicolored LCD Display

The HI981413 features a multi-colored LCD that provides for a quick way to see the status of the controller. If in control mode and operating as intended the display will be green. If control is not enabled then the display will be yellow; while in an alarm state the display flashes red.



### Automatic Proportional Pump Control

The peristaltic dosing pump can be controlled by simple on/off or more advanced proportional control which helps prevent overshooting of the set point. When using proportional control the flow rate that is programmed, will be impacted by the proportional band used. The closer the reading is to the set point the longer it takes for the peristaltic pump to complete one revolution. If the reading is outside the proportional band then the amount of time it takes to complete one revolution is based on the flow rate programmed.



For example, a controller is programmed to have a set point of 1.50 mS/cm with a 0.30 mS/cm proportional band and the flow rate at 1 L/h. Any reading below 1.20 mS/cm will cause the dosing of stock fertilizer to be at 1 L/h. If the reading is at 1.35 mS/cm, which is 1/2 of the band, then the dosing pump will run at half speed or deliver 0.5 L/h of chemical. The closer the reading is to the set point the longer it takes for the pump to complete one rotation. This allows for very fine control of the EC/TDS value desired.

## HI30033 EC/Temperature Probe

The HI981413 uses the HI30033 probe that incorporates both EC (TDS) and temperature sensors and connects to the controller with a single waterproof Quick Connect DIN connector. The PVDF body of the probe has a 1/2" threaded fitting for insertion to an in-line "T" fitting or the flow cell. The back end part of the probe has 3/4" NPT threads for submersion/tank mounting. The probe body has a hex fitting for tightening snugly with a wrench.



Specifications	HI981413	
EC	Range	0.00 to 10.00 mS/cm
	Resolution	0.01 mS/cm
	Accuracy (@25°C/77°F)	±2% F.S.
	Calibration	user calibration: automatic, one-point with standard solution (1.41 or 5.00 mS/cm) Process calibration: single point, adjustable (±0.50 mS/cm around measured value)
TDS	Range	0 to 9900 ppm (depends on factor selection)
	Resolution	1 ppm
	Accuracy (@25°C/77°F)	±2% F.S.
	Calibration	through EC calibration
EC to TDS Conversion Factor		TDS conversion factor selectable from 0.45 to 0.99
Temperature	Range	-5.0 to 105.0°C (23.0 to 221.0°F)
	Resolution	0.1°C (0.1°F)
	Accuracy (@25°C/77°F)	±0.5°C (±0.9°F)
Temperature Compensation		automatic
Temperature Correction Coefficient		$\beta$ can be set from 0%/°C to 2.4%/°C; default is 1.9%/°C
Dosing Control Type		On/Off control using adjustable set point (0.10 to 10.00 mS/cm; 45 to 9900 ppm) with adjustable hysteresis (0.05 to 0.50 mS/cm; 23 to 990 ppm) proportional control using adjustable set point (0.10 to 10.00 mS/cm; 45 to 9900 ppm) with adjustable proportional band (0.05 to 1.00 mS/cm; 23 to 990 ppm)
Dosing Control Activation		high or low mode operation high set point dosing is activated when reading is higher than set point low set point dosing is activated when reading is lower than set point (dose fertilizer)
Delay Start for Dosing		startup delay timer at power-on (0 to 600 sec.)
Maximum Dosing Time		overfeed protection using overtime safety timer (1 to 180 min. or Off)
Pump Flow Control		selectable flow rate (0.5 to 3.5 L / hour; 0.13 to 0.92 G/hour) manual control for pump priming
Additional Specifications	Alarms	high and low with enable / disable option triggered after 5 sec. if controller records a set of consecutive readings over / under threshold values level with enable / disable option Overtime protection (1 to 180 min. or off) intuitive alarm system using red, light green, and green color-coded backlight
	Alarm Relay Output (1)	SPDT 2.5A / 230 VAC
	External Event Input	input for level controller or flow switch to disable dosing pump in the event of no chemical when using a level controller or no flow when using a flow switch - galvanically isolated
	Probe Input (1)	HI30033 EC/TDS/Temperature probe with quick connect DIN connector - galvanically isolated
Power Supply		100-240 VAC, 50/60 Hz
Power Consumption		15 VA
Environment		0-50°C (32-122°F), max. 95% RH non-condensing
Dimensions		90 x 142 x 80 mm (3.5 x 5.6 x 1.8")
Weight		908 g (36 oz)
Casing		wall mounted, built-in pump, IP65 rated

**HI981413-00** is supplied with HI981413 controller, HI30033 EC/TDS/temperature probe, 1413  $\mu$ S/cm conductivity calibration solution (120 mL), plastic beaker, power connection cable, instruction manual and quality certificates for instrument and probe.

**HI981413-10** (with in-line mounting kit) is supplied with HI981413 controller, HI30033 EC/TDS/temperature probe, 1413  $\mu$ S/cm conductivity calibration solution (120 mL), controller aspiration filter, controller injector with 1/2" thread, saddle for  $\varnothing$  50 mm pipe (2), PVC aspiration tubing (flexible) (5 m), PE rigid dispensing tubing (for pump to injector) (5 m), plastic beaker, power connection cable, instruction manual and quality certificates for instrument and probe.

**HI981413-20** (with flow-cell mounting kit) is supplied with HI981413 controller, HI30033 EC/TDS/temperature probe, 1413  $\mu$ S/cm conductivity calibration solution (120 mL), flow cell for HI981413, mounting panel assembly for HI981413, controller aspiration filter, controller injector with 1/2" thread, saddle for  $\varnothing$  50 mm pipe (3), PVC aspiration tubing (flexible) (5 m), PE rigid dispensing tubing (for pump to injector) (15 m), barbed tubing adapter (1/2" - 6 mm)(2), flow cell valve (2), plastic beaker, power connection cable, instruction manual and quality certificates for instrument and probe.

### Ordering Information



**BL120-410**  
Flow cell



**BL120-450**  
Flow-cell kit for 50 mm pipe diameter



**BL120-463**  
Flow-cell kit for 63 mm pipe diameter



**BL120-475**  
Flow-cell kit for 75 mm pipe diameter



**BL100-421**  
Flow cell panel

**BL100-400**

Probe adapter kit (contains adapter, fixing nut, O-ring)



**BL120-263**  
Injector saddle for 63 mm pipe diameter, 1/2" thread



**BL120-250**  
Injector saddle for 50 mm pipe diameter, 1/2" thread



**BL120-275**  
Injector saddle for 75 mm pipe diameter, 1/2" thread



**BL120-401**  
Flow-cell valve



**BL120-201**  
Pool Controller injector, 1/2" thread



**BL120-200**  
Pool Controller aspiration filter



**BL100-300**  
Pool Controller peristaltic pump tubing kit (2 pcs.)



**BL120-202**  
Aspiration and dispersion tubing (10 m)



**BL120-301**  
Peristaltic pump rotor



**HI740036P**  
Plastic beaker set, 100 mL (10 pcs.)



**HI30033**  
EC/TDS/temperature probe with 2 m cable, DIN Quick connect



**BL100-302**  
Pool Controller pump cover with screw



**HI7031-012**  
1413  $\mu\text{S/cm}$  (1.41 mS/cm) solution (Groline®), 120 mL



**HI7039-023**  
5000  $\mu\text{S/cm}$  (5.00 mS/cm) solution (Groline), 230 mL

**HI7031-023**  
1413  $\mu\text{S/cm}$  (1.41 mS/cm) solution (Groline®), 230 mL

**HI7039-050**  
5000  $\mu\text{S/cm}$  (5.00 mS/cm) solution (Groline), 500 mL

BL100

## pH Controller and Dosing Pump

for Swimming Pools, Hot Tubs, and Spas

BL100 pH Controller and Dosing Pump is a system engineered for maintaining the pH of swimming pools, hot tubs, and spas. Typically chlorine, whether liquid or solid, is alkaline and will raise the pH of the water that it is added to. As the pH increases above 7.4, a form of chlorine known as hypochlorite ion ( $\text{OCl}^-$ ) increases. This form of chlorine is 100 times less effective at killing bacteria as compared to the other form of chlorine known as hypochlorous acid ( $\text{HOCl}$ ). For this reason it is important to maintain the correct pH level in order to ensure that the more powerful hypochlorous acid form is available for disinfection. The BL100 was developed to be an inexpensive solution for the consumer to maintain the ideal pH level at all times. Simply insert the probe and injection valve in-line with the recirculation pump and provide the chemical to be dosed.

*The BL100 is available in multiple configurations including a meter and probe option, a kit for in-line mounting, and a complete package that includes bypass loop and panel mounted flow cell. The kit for in-line and flow cell models include aspiration tubing with filter and dispensing tubing with injection valve.*



HI10053 Amplified pH/Temperature Probe



## Features



### Peristaltic Dosing Pump

The BL100 has a powerful built-in peristaltic chemical feed pump that utilizes a stepper motor which does not have any gears or brushes to wear out. This design provides for a long life and little maintenance.



### Quick Connect Probe Input

The Quick Connect DIN connector creates a waterproof seal with the controller making it ideal for reducing electrical noise issues with the connection caused by humid environments.



### Acid Tank Level/Flow Switch Input

The BL100 allows for a connection to an optional level controller or flow switch. This input can be used to disable the dosing pump when there is no chemical left in the reservoir tank or there is no flow due to the pump being turned off.

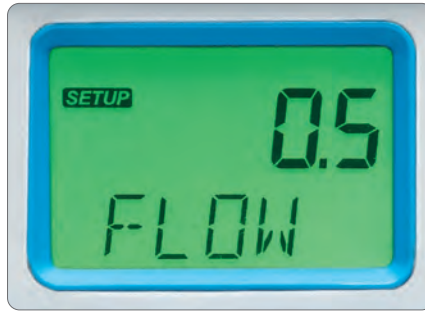

### Adjustable Flow Rate

The flow rate from the dosing pumps is adjustable from 0.5 to 3.5L/h. Larger bodies of water require more chemical to be dosed than smaller ones in per unit of time. The adjustable flow rate, like the proportional band, allows for better control in maintaining a desired set point



### Automatic Proportional Pump Control

The peristaltic dosing pump can be controlled by simple on/off or more advanced proportional control which helps prevent overshooting of the set point. When using proportional control the flow rate that is programmed, will be impacted by the proportional band used. The closer the reading is to the set point the longer it takes for the peristaltic pump to complete one revolution. If the reading is outside the proportional band then the amount of time it takes to complete one revolution is based on the flow rate programmed.



### Programmable Alarm System

Enables or disables the low and high-level alarms for pH. When an alarm is activated, all dosing will stop. For added safety, the alarm system also offers overdosing protection in that if the set point value is not corrected within a programmed time interval then the meter will go into alarm status.



For example, a controller is programmed to have a set point of pH 7.40 with a 1.00 pH unit proportional band and the flow rate at 1.0 L/h. Any reading above pH 8.4 will cause the dosing of acid to be at 1 L/h. If the reading is at pH 7.90, which is 1/2 of the band, then the dosing pump will run at half speed or deliver 0.5 L/h of chemical. The closer the reading is to the set point the longer it takes for the pump to complete one rotation. This allows for very fine control of the pH value desired.



### Multicolored LCD Display

The BL100 features a multi-colored LCD that provides for a quick way to see the status of the pool controller. If in control mode and operating as intended the display will be green. If control is not enabled then the display will be light green; while in an alarm state the display flashes red.

## HI10053 Amplified pH/Temperature Probe

The BL100 uses the HI10053 amplified probe that incorporates both pH and temperature sensors and connects to the controller with a single waterproof Quick Connect DIN connector. The built in amplifier helps to reduce electrical noise from recirculation pumps to provide for a stable, reliable measurement. The pH glass used is ideal for low conductivity water and provides for fast response. The PVDF body of the probe has a 1/2" threaded fitting for insertion to an in-line "T" fitting or the flow cell. The probe body has a hex fitting for tightening snugly with a wrench.

As an additional safety feature, the pH sensor is designed to have 0 mV value for pH 4 and not at pH 7 like typical pH electrodes. This is very important since a 0 mV potential will result when the internal glass is cracked and shorts with the reference cell. For the HI10053 the 0 mV value will be pH 4 and this type of reading will produce an alarm state (when programmed) and disable the pump from dosing. A standard pH electrode would have a pH value close to 7 and could result in either no dosing or excessive dosing based on the actual value and programmed set point.

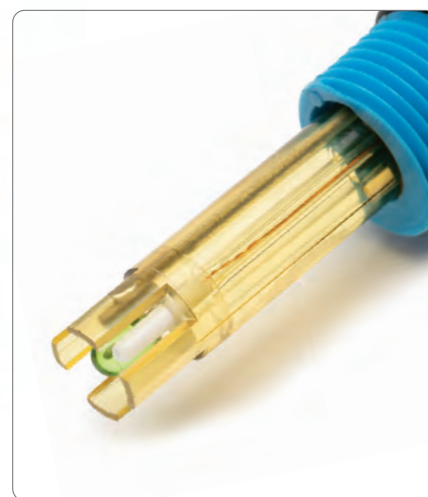

Specifications	BL100	
pH	Range*	0.00 to 14.00 pH
	Resolution	0.01 pH
	Accuracy (@25°C/77°F)	±0.10 pH
	Calibration	user calibration: automatic, one or two-point with buffer solution (4.01, 7.01, 10.01 pH) Process calibration: single point, adjustable (± 0.50 pH around measured pH)
Temperature	Range*	-5.0 to 105°C (23.0 to 221.0°F)
	Resolution	0.1°C (0.1°F)
	Accuracy (@25°C/77°F)	±0.5°C (±0.9°F)
	Temperature Compensation	automatic
	Dosing Control Type	On/Off control using adjustable set point (6.00 to 8.00 pH) with adjustable hysteresis (0.10 to 1.00 pH) Proportional control using adjustable set point (6.00 - 8.00 pH) with adjustable proportional band (0.10 to 2.00 pH)
	Dosing Control Activation	high or low mode operation high set point dosing is activated when reading is higher than set point (dose acid) low set point dosing is activated when reading is lower than set point (dose base)
	Delay Start for Dosing	startup delay timer at power-on (0 to 600 sec.)
	Maximum Dosing Time	overfeed protection using overtime safety timer (1 to 180 min. or Off)
	Pump Flow Control	selectable flow rate (0.5 to 3.5 L / hour; 0.13 to 0.92 G/hour) manual control for pump priming
Additional Specifications	Alarms	high and low with enable / disable option triggered after 5 sec. if controller records a set of consecutive readings over / under threshold values level with enable / disable option overtime protection (1 to 180 min. or off) intuitive alarm system using red, light green, and green color-coded backlight
	Alarm Relay Output (1)	SPDT 2.5A / 230 VAC
	External Event Input	input for level controller or flow switch to disable dosing pump in the event of no chemical when using a level controller or no flow when using a flow switch - galvanically isolated
	Probe Input (1)	HI10053 digital pH/temperature probe with quick connect DIN connector - galvanically isolated
	Power Supply	100-240 VAC, 50/60 Hz
	Power Consumption	15 VA
	Environment	0-50°C (32-122°F), max. 95% RH non-condensing
	Dimensions	90 x 142 x 80 mm (3.5 x 5.6 x 1.8")
	Weight	910 g (32 oz.)
	Casing	wall mounted, built-in pump, IP65 rated

**BL100-00** is supplied with BL100 controller, HI10053 pH/temperature probe, 4.01 pH buffer solution, 20 mL (3), 7.01 pH buffer solution, 20 mL (3), power connection cable, instruction manual and quality certificates for instrument and probe.

**BL100-10** (with in-line mounting kit) is supplied with BL100 controller, HI10053 pH/temperature probe, pool controller aspiration filter, pool controller injector, 1/2" thread, saddle for Ø 50 mm pipe (2), PVC aspiration tubing (flexible) (5 m), PE rigid dispensing tubing (5 m), 4.01 pH buffer solution, 20 mL (3), 7.01 pH buffer solution, 20 mL (3), power connection cable, instruction manual and quality certificates for instrument and probe.

**BL100-20** (with flow cell mounting kit) is supplied with BL100 controller, HI10053 pH/temperature probe, flow cell for BL100/BL101, mounting panel assembly for BL100/BL101, pool controller aspiration filter, pool controller injector, 1/2" thread, saddle for Ø 50 mm pipe (3), PVC aspiration tubing (flexible) (5 m), PE rigid dispensing tubing (15 m), barbed tubing adapter 1/2" - 6 mm (2), valves (2), 4.01 pH buffer solution, 20 mL (3), 7.01 pH buffer solution, 20 mL (3), power connection cable, instruction manual and quality certificates for instrument and probe.

### Ordering Information



**BL120-410**  
Flow cell



**BL120-450**  
Flow-cell kit for 50 mm pipe diameter



**BL120-463**  
Flow-cell kit for 63 mm pipe diameter



**BL120-475**  
Flow-cell kit for 75 mm pipe diameter



**BL100-421**  
Flow cell panel

**BL100-400**  
Probe adapter kit (contains adapter, fixing nut, O-ring)



**BL120-263**  
Injector saddle for 63 mm pipe diameter, 1/2" thread



**BL120-250**  
Injector saddle for 50 mm pipe diameter, 1/2" thread



**BL120-275**  
Injector saddle for 75 mm pipe diameter, 1/2" thread



**BL120-401**  
Flow-cell valve



**BL120-201**  
Pool Controller injector, 1/2" thread



**BL120-200**  
Pool Controller aspiration filter



**BL100-300**  
Pool Controller peristaltic pump tubing kit (2 pcs.)



**BL120-202**  
Aspiration and dispersion tubing (10 m)



**BL120-301**  
Peristaltic pump rotor



**HI740036P**  
Plastic beaker set, 100 mL (10 pcs.)



**HI10053**  
pH/temperature probe with 2 m cable, DIN Quick connect



**BL100-302**  
Pool Controller pump cover with screw

BL101

## ORP Controller and Dosing Pump

for Swimming Pools, Hot Tubs, and Spas

BL101 ORP Controller and Dosing Pump is a system engineered for maintaining the ORP of swimming pools, hot tubs, and spas. Typically, liquid chlorine is used as a disinfectant to keep the water safe from harmful bacteria. Chlorine, as an oxidizer, will increase the oxidation-reduction potential (ORP) of water when it is added to it. When the ORP value is greater than 650 mV then bacteria that are present will be killed within seconds. The BL101 was developed to be an inexpensive solution for the consumer to maintain the ideal ORP value at all times. Simply insert the probe and injection valve in-line with the recirculation pump and provide the chemical to be dosed.

*The BL101 is available in multiple configurations including a meter and probe option, a kit for in-line mounting, and a complete package that includes bypass loop and panel mounted flow cell. The kit for in-line and flow cell models include aspiration tubing with filter and dispensing tubing with injection valve.*



HI20083 ORP/Temperature Probe shown in-line





## Features



### Peristaltic Dosing Pump

The BL101 has a powerful built-in peristaltic chemical feed pump that utilizes a stepper motor which does not have any gears or brushes to wear out. This design provides for a long life and little maintenance.



### Quick Connect Probe Input

The Quick Connect DIN connector creates a waterproof seal with the controller making it ideal for reducing electrical noise issues with the connection caused by humid environments.



### Acid Tank Level/Flow Switch Input

The BL101 allows for a connection to an optional level controller or flow switch. This input can be used to disable the dosing pump when there is no chemical left in the reservoir tank or there is no flow due to the pump being turned off.



### Adjustable Flow Rate

The flow rate from the dosing pumps is adjustable from 0.5 to 3.5L/h. Larger bodies of water require more chemical to be dosed than smaller ones in per unit of time. The adjustable flow rate, like the proportional band, allows for better control in maintaining a desired set point.



### Automatic Proportional Pump Control

The peristaltic dosing pump can be controlled by simple on/off or more advanced proportional control which helps prevent overshooting of the set point. When using proportional control, the flow rate that is programmed, will be impacted by the proportional band used. The closer the reading is to the set point the longer it takes for the peristaltic pump to complete one revolution. If the reading is outside the proportional band then the amount of time it takes to complete one revolution is based on the flow rate programmed.



### Programmable Alarm System

Enables or disables the low and high level alarms for ORP. When an alarm is activated, all dosing will stop. For added safety, the alarm system also offers overdosing protection in that if the set point value is not corrected within a programmed time interval then the meter will go into alarm status.



For example, a controller is programmed to have a set point of 650 mV with a 50 mV proportional band and the flow rate at 1.0 L/h. Any reading below 600 mV will cause the dosing of the oxidizer to be at 1 L/h. If the reading is at 625 mV, which is 1/2 of the band, then the dosing pump will run at half speed or deliver 0.5 L/h of chemical. The closer the reading is to the set point the longer it takes for the pump to complete one rotation. This allows for very fine control of the ORP value desired.



### Multicolored LCD Display

The BL101 features a multi-colored LCD that provides for a quick way to see the status of the pool controller. If in control mode and operating as intended the display will be green. If control is not enabled then the display will be light green; while in an alarm state the display flashes red.

## HI20083 ORP/Temperature Probe

The BL101 uses the HI20083 probe that incorporates both ORP and temperature sensors and connects to the controller with a single waterproof Quick Connect DIN connector. The PVDF body of the probe has a 1/2" threaded fitting for insertion to an in-line "T" fitting or the flow cell. The back end part of the probe has 3/4" NPT threads for submersion/tank mounting. The probe body has a hex fitting for tightening snugly with a wrench.

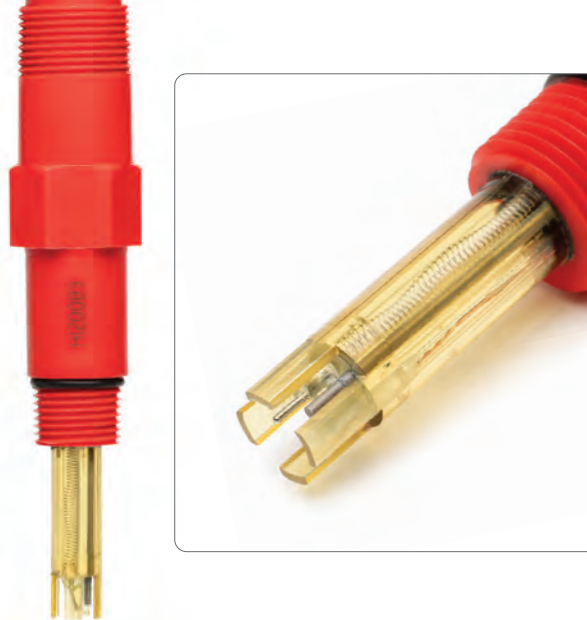

Specifications	BL101	
ORP	Range	-2000 to 2000 mV
	Resolution	1 mV
	Accuracy (@25°C/77°F)	±5 mV
	Calibration	process calibration: single point, adjustable (± 50 mV around measured ORP value)
Temperature	Range*	-5.0 to 105°C (23.0 to 221.0°F)
	Resolution	0.1°C (0.1°F)
	Accuracy (@25°C/77°F)	±0.5°C (±0.9°F)
Additional Specifications	Dosing Control Type	On/Off control using adjustable set point (200 to 900 mV) with adjustable hysteresis (10 to 100 mV) proportional control using adjustable set point (200 to 900 mV) with adjustable proportional band (10 to 200 mV)
	Dosing Control Activation	high or low mode operation high set point dosing is activated when reading is higher than set point low set point dosing is activated when reading is lower than set point (dose oxidizer)
	Delay Start for Dosing	startup delay timer at power-on (0 to 600 sec.)
	Maximum Dosing Time	overfeed protection using overtime safety timer (1 to 180 min. or Off)
	Pump Flow Control	selectable flow rate (0.5 to 3.5 L / hour; 0.13 to 0.92 G/hour) manual control for pump priming
	Alarms	high and low with enable / disable option triggered after 5 sec. if controller records a set of consecutive readings over / under threshold values level with enable / disable option overtime protection (1 to 180 min. or off) intuitive alarm system using red, light green, and green color-coded backlight
	Alarm Relay Output (1)	SPDT 2.5A / 230 VAC
	External Event Input	input for level controller or flow switch to disable dosing pump in the event of no chemical when using a level controller or no flow when using a flow switch - galvanically isolated
	Probe Input (1)	HI20083 Platinum tip ORP/Temperature probe with quick connect DIN connector - galvanically isolated
	Power Supply	100–240 VAC, 50/60 Hz
	Power Consumption	15 VA
	Environment	0-50°C (32-122°F), max. 95% RH non-condensing
	Dimensions	90 x 142 x 80 mm (3.5 x 5.6 x 1.8")
	Weight	910 g (32 oz.)
	Casing	wall mounted, built-in pump, IP65 rated

**BL101-00** is supplied with BL101 controller, HI20083 ORP/temperature probe, ORP test solution (3), power connection cable, instruction manual and quality certificates for instrument and probe.

**BL101-10** (with in-line mounting kit) is supplied with BL101 controller, HI20083 ORP/temperature probe, pool controller aspiration filter, pool controller injector, 1/2" thread, saddle for Ø 50 mm pipe (2), PVC aspiration tubing (flexible) (5 m), PE rigid dispensing tubing (5 m), ORP test solution (3), power connection cable, instruction manual and quality certificates for instrument and probe.

**BL101-20** (with flow cell mounting kit) is supplied with BL101 controller, HI20083 ORP/temperature probe, flow cell for BL100/BL101, mounting panel assembly for BL100/BL101, pool controller aspiration filter, pool controller injector, 1/2" thread, saddle for Ø 50 mm pipe (3), PVC aspiration tubing (flexible) (5 m), PE rigid dispensing tubing (15 m), tubing adapter 1/2" - 6 mm (2), valves (2), ORP test solution, 20 mL (3), power connection cable, instruction manual and quality certificates for instrument and probe.

\*range limited by probe.



**BL120-410**  
Flow cell



**BL120-450**  
Flow-cell kit for 50 mm pipe diameter



**BL120-463**  
Flow-cell kit for 63 mm pipe diameter



**BL120-475**  
Flow-cell kit for 75 mm pipe diameter



**BL100-421**  
Flow cell panel

**BL100-400**  
Probe adapter kit (contains adapter, fixing nut, O-ring)



**BL120-263**  
Injector saddle for 63 mm pipe diameter, 1/2" thread



**BL120-250**  
Injector saddle for 50 mm pipe diameter, 1/2" thread



**BL120-275**  
Injector saddle for 75 mm pipe diameter, 1/2" thread



**BL120-401**  
Flow-cell valve



**BL120-201**  
Pool Controller injector, 1/2" thread



**BL120-200**  
Pool Controller aspiration filter



**BL100-300**  
Pool Controller peristaltic pump tubing kit (2 pcs.)



**BL120-202**  
Aspiration and dispersion tubing (10 m)



**BL120-301**  
Peristaltic pump rotor



**HI740036P**  
Plastic beaker set, 100 mL (10 pcs.)



**HI20083**  
ORP/temperature probe with 2 m cable, DIN Quick connect



**BL100-302**  
Pump cover with screw



HI520-0540 shown

HI510 • HI520

## Single and Dual-Channel Universal Process Controllers

- Waterproof IP65 (NEMA 4X) enclosure
- Large backlit LCD
- Multi-color LED status indicators
- Audible alarm
- Tactile rubberized keypad
- Universal mounting
- Universal Hanna digital probe

HI510 and HI520 are advanced process controllers that can be configured for applications requiring monitoring and/or control of four main water-analysis parameters: pH, ORP, Conductivity, and Dissolved Oxygen.

These controllers feature a digital probe input(s) that automatically detects and updates the controller with the parameter that it measures.

HI520 is Hanna's first dual-input process controller that accepts virtually any combination of compatible probes. Designed to adapt to unique process control requirements, users have the option to enable or disable each channel independently.

Additionally, HI520 introduces enhanced industrial control by operating a control-loop system whereby users have the option to run channel control either independently or configure to be triggered sequentially upon

reaching the other channel's set point(s) (1, 2, or both). The device operates a logical channel with built-in mathematical functions. This function is intended for when the controller works as an analyzer for monitoring high/low parameter levels between two identical inputs with identical measuring configurations.

These Universal Process Controllers offer wall, pipe, and panel mounting options and feature a large backlit dot matrix display for easy viewing and provide an intuitive interface for setup options.

The controllers utilize multi-color LEDs for easy viewing of the instrument's status including relay activation, in alarm mode, or in hold status. All programming operations are done through the low profile vulcanized rubber keypad or with an RS485 connection to a Modbus-compliant supervisory computer.

## Features Displayed on Screen (HI520 display shown)

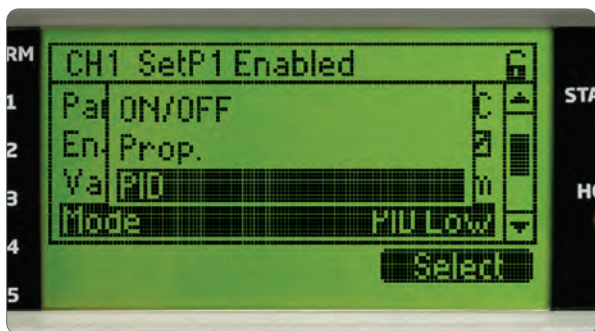

### Control Modes

The control mode can be configured to be On/Off, Proportional, or PID. The mode can be set high or low. High control mode is required if the process value is too high and needs to be decreased. Low control mode is required if the process value is too low and needs to be increased.

For On/Off control, the hysteresis band is adjustable, while in Proportional and PID modes, deviation, control period, and other tuning parameters can be set to optimize control around a set point.

For HI520, each channel can run control independently or sequentially.

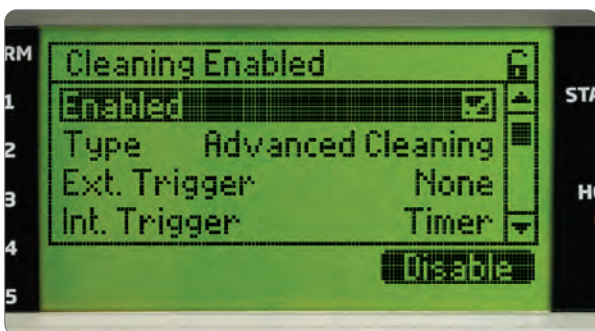

### Auto-Cleaning Cycle

Difficult applications often require an almost continuous maintenance of the probe. Processes with high-suspended solids, fats, oils, pigments, and microorganisms will coat the pH sensing glass, ORP sensors, and the reference junction. The cleaning function allows programming of one or more wash cycles and uses the relays to activate valves, pumps or compressed air based on the type of washing that is required to maintain probes for reliable results.

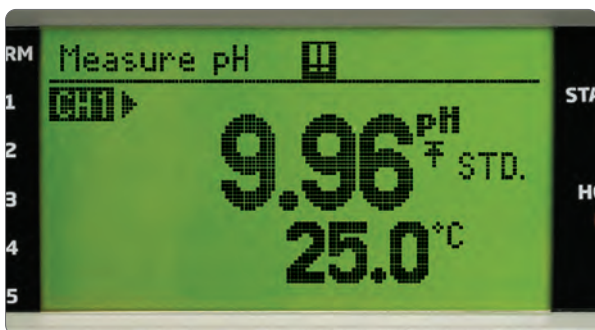

### LCD Information

Local visual indicators of measurement details as well as errors are displayed. The ? DIAG key provides details of the issue.

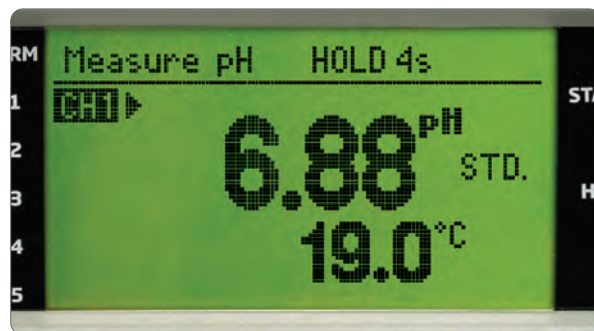

### Hold Function

During calibration, cleaning, and configuration the controller automatically goes into Hold mode. During Hold mode all control loops related are disabled. The analog outputs may be configured to go to a fixed value or remain at the last value.

The Hold function can also be triggered manually, using an external digital input or by entering in Manual mode. This is useful for disabling control when performing maintenance.



### Configurable Alarm System

The alarm system is configurable for measured parameters. The alarm can also be activated by event triggers or abnormal operation. For example, if a dosing relay remains closed for an excessive period of time or if temperature exceeds an upper limit during an exothermic neutralization reaction. A blinking red LED signals an alarm state. All relays configured for control are inactivated until the alarm state is resolved.

On HI520 use channel configuration to setup and trigger an alarm.

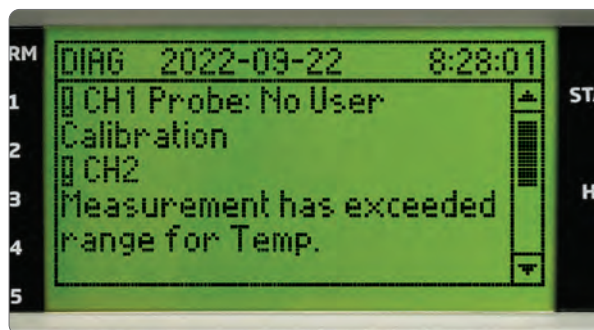

### ? DIAG - Help and Diagnostic Key

The help and diagnostic key (? DIAG) provides information related to errors; or in setup mode, information about settings.



HI520 shown

### Digital Inputs

- Two digital inputs for remotely triggering, cleaning and hold functions

### Analog Outputs

- Up to 4 analog outputs and 5 relays used for control and for sending a signal to data loggers, PLC, SCADA and other remote monitoring systems
- 0-20 mA or 4-20 mA
- Scalable in selecting values for the range
- Can be used for control of pumps and valves
- On alarm state can output a 22 mA signal to the monitoring system

### Digital Communication

- The Modbus-compliant unit can be integrated within a Modbus-based network and connected to other industrial electronic devices. The following tasks may be accomplished remotely:
  - Monitoring, using the virtual LCD (limited to a single remote control in the entire network)
  - Setup
  - Loading the Setup configuration file to a controller
- RS485 Digital output for PC and other device connectivity

### Relays

- Up to 5 control and 1 alarm electromechanical relays
- Replaceable 5A fuses to protect all relays
- Extractable terminal blocks for easy wiring
- Relay options include single pole double throw (SPDT) and single pole single throw (SPST)
- Control relays can be programmed for On/Off, Proportional, or PID control as well as Cleaning and Hold functions
- Configurable alarm relay
- Relays terminal blocks and their wires paths are separated from the low voltage section for additional safety



### Automatic Data-logging

HI510 and HI520 have built-in data logging that stores data at selectable intervals along with relay control settings and calibration data.

- Data stored in up to 100 lots with each holding 8600 records
- Selectable log interval: from 10 seconds to 3 hours
- Logged Data includes:
  - Measured values and alarms for all supported parameters
  - Calibration information including solutions used. For pH, the offset and slope is recorded.

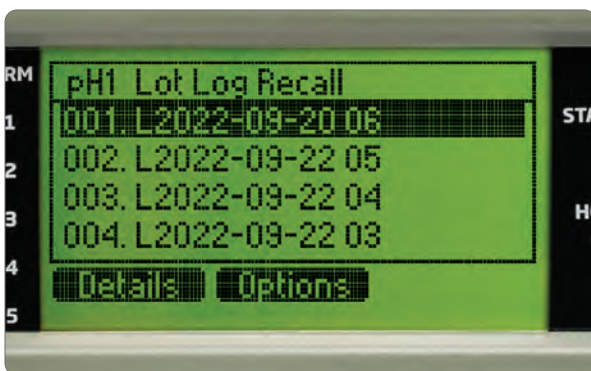

### Event Log

The Event Log file can hold a maximum of 100 events. It includes errors, alarms, warnings, calibration events, configuration changes, and cleaning events.



### Password protection

The controllers feature password protected calibration and setup.



### NEMA 4X Enclosure

The controllers are suitable for indoor or outdoor environments. The NEMA 4X enclosure ensures the electronics are protected against splashing and hose-directed water or windblown dirt, dust, rain or sleet. It also provides corrosion protection for use near salt water.



### Cable Glands

To maintain the NEMA 4X enclosure rating during use, the conduit openings and connection cables are sealed against the environment using the provided cable glands, seals, and plugs.



### Spring Loaded Screws

The front panel is hinged at the front of the enclosure for easy access to wiring locations. It features spring loaded screws that won't fall out when accessed.



### USB Type-C Port

Logged data can be transferred to a flash drive as a .csv file using the USB Type-C port. A rubberized plug helps protect the port against the ingress of water.





The controllers can be securely panel mounted through a ½ DIN opening using the HI510-01 Panel-Mount Kit. The kit includes a sealing gasket, dual zinc coated brackets, and associated hardware.





The controllers can be surface mounted using the HI510-02 Wall-Mount Kit. The kit includes a zinc coated mounting plate and associated hardware. The plate may be oriented vertically or horizontally.



The controller can be mounted to a vertical or horizontal pipe using the HI510-03 Pipe-Mount Kit. The kit includes a zinc coated mounting plate, associated hardware, and U-bolts to accommodate a 1", 1½", or 2" pipe.



HI510-0540

HI510-0320

HI520-0540

HI520-0320

Specifications	HI510	HI520
Digital Probes	See the following pages	
Channels	1	2
Display	Graphic LCD, 128 x 64 pixel B/W with backlight	
Digital Inputs	2 independent, galvanically isolated inputs (configurable for Hold & Cleaning functions) On state: 5 to 24 Vdc, low or high level active	
Analog Outputs	2 or 4 independent, galvanically isolated outputs 0 – 22 mA configurable as: 0 – 20 mA; 4 – 20 mA 22 mA as alarm signal, configurable option	
Analog Output Accuracy	±0.2% f.s.	
Digital Communication	RS485 serial port - Remote monitoring and control USB-C port - Retrieve log files and firmware upgrading	
Relays	Up to 5 relays (independently configurable for process variables, Hold & Cleaning functions) Electromechanical relay SPDT and SPST contact outputs 5A - 250 Vac; 5A - 30 Vdc (resistive load) Fuse protected: 5A, 250V slow blow fuse	
Alarm Relay for All Measurement Alarms	Electromechanical relay SPDT contact output 5A - 250 Vac; 5A - 30 Vdc (resistive load) Fuse protected: 5A, 250V slow blow fuse	
Data Logging	Interval log, up to 100 files, maximum 8600 records on each stored file. When the maximum limit of 100 stored files is reached, the most recent file will automatically erase the oldest one. Event log, maximum 100 records. When the maximum limit is reached, the last record overwrites the oldest one.	
Power Supply	100 – 240 Vac ±10%; 50/60 Hz; 15VA; fuse protected (2A, 250V slow blow fuse)	
Power Consumption	15VA	
Installation Category	II	
Environment	-20 to 50 °C (-4 to 122 °F); maximum 100% RH non-condensing	
Enclosure*	Single case ½ DIN, type 4X, IP65 ingress protection	
Weight	Approximately 1.6 kg (3.5 lb.)	
Dimensions	Width: 144.0 mm (5.7") Height: 144.0 mm (5.7") Depth: 151.3 mm (6.0")	
Ordering Information	<p><b>HI510-0540</b> universal process controller with 5 relays and 4 analog outputs is supplied with 3m power cable, cable gland set, instrument certificate, and quick reference guide with instructions for manual download.</p> <p><b>HI510-0320</b> universal process controller with 3 relays and 2 analog outputs is supplied with 3m power cable, cable gland set, instrument certificate, and quick reference guide with instructions for manual download.</p> <p><b>HI520-0540</b> universal process controller with 5 relays and 4 analog outputs is supplied with 3m power cable, cable gland set, instrument certificate, and quick reference guide with instructions for manual download.</p> <p><b>HI520-0320</b> universal process controller with 3 relays and 2 analog outputs is supplied with 3m power cable, cable gland set, instrument certificate, and quick reference guide with instructions for manual download.</p>	
Accessories	<p><b>HI510-01</b> panel-mount kit</p> <p><b>HI510-02</b> wall-mount kit</p> <p><b>HI510-03</b> pipe-mount kit</p> <p><b>HI76510-05</b> patch cable, 5 m (16'5")</p>	<p><b>HI76510-10</b> patch cable, 10 m (32'9")</p> <p><b>HI76510-15</b> patch cable, 15 m (49'2")</p> <p><b>HI76510-25</b> patch cable, 25 m (82')</p> <p><b>HI76510-50</b> patch cable, 50 m (164')</p>

\* For a water tight seal: Gland seals need to be used over cables and the four screws on the front casing need to be tightened to 13.3 lbf/in (1.5 N·m, maximum 2.0 N·m), of torque.



HI2004-18 • HI2014-18  
HI2004-28 • HI2014-28

## ORP and Temperature Industrial Smart Probes

HI510 and HI520 Universal Process Controller compatible

HI20X4-18 and HI20X4-28 are ORP and temperature probes designed for use with the Hanna Instruments® HI510 or HI520. The system is designed to monitor and control disinfection chemicals or follow and control a critical oxidation (or reduction) reaction. mV measurements are auto-compensated for barometric pressure and temperature.

- HI2004-18 and HI2014-18 platinum-sensor series are designed to provide the best response over a wide range of applications. Used in reducing processes such as chlorine dosing in pools and spas or chromate reduction.
- HI2004-28 and HI2014-28 gold-sensor series are designed for oxidative processes such as cyanide oxidation in the mining industry.

The probe features a flat tip (ideal for solutions containing aggressive chemicals) which virtually eliminates dirt deposits and significantly reduces maintenance.

Suitable for continuous measurement of ORP required for monitoring and/or controlling oxidizers and reducing agents in water treatment monitoring, industrial effluent treatment, and swimming pools, the probe can be submersed/immersed using the 3/4" NPT threads, or installed directly in-line or in a flow cell installation, using the lower sensor threads.

The probe is also available with an integral connector that permits cable connections after installation.

Patch cables may be purchased separately to connect between the probe and controller up to 50 meters (164 ft).

- Rugged, chemically-resistant PVDF body
- 3/4" NPT external thread
- 6 bar (87 psi) maximum pressure at 25 °C (77 °F)
- Built-in temperature sensor for measurement
- Digital probe stores model, firmware, serial number, and calibration information
- Minimum maintenance

Specifications	example HI2004-18zz	
ORP	Range	-2000 to +2000 mV
	Resolution	1 mV
	Accuracy	±2 mV
	Calibration	Single point, value can be adjusted ±60 mV around measured mV
Temperature	Range	-5.0 to 100.0 °C (23.0 to 212.0 °F)
	Resolution	0.1 °C; 0.1 °F
	Accuracy	±0.5 °C; ±1.0 °F
	Calibration	Single point offset (controller setting)
Temperature Source	Automatic (from Probe) Manual	
Body	PVDF	
Junction	PTFE	
Sensor	Material	platinum
	Body	glass
	Tip shape	flat
	Diameter	22 mm (0.9")
	Insertion length	21 mm (0.8")
Maximum Pressure	6 bar	
Threaded Connection	3/4" NPT external thread for mounting	
Wetted Parts	Probe body	PVDF
	Sensor body	glass
	O-ring	NBR
	Junction	PTFE
	Matching pin	titanium
Protection Rating	IP68	
Cable Length	zz, see Ordering Information	

**PTFE junction:** Minimizing the potential for clogging and chemically resistant, PTFE is ideal for samples with high content of suspended solids or for high-pressure installations.

**Ceramic junction:** Porous chemically resistant plug that connects the reference electrode to the process electrically.

### Ordering Information

Each probe is supplied with quick reference guide with probe quality certificate.

**HI20** x x - y 8 z z

Choose your configuration:		
xx	04	PTFE junction
	14	Ceramic junction
y	1	Platinum sensor; -5.0 to 100.0 °C (23.0 to 212.0 °F); ±2000 mV
	2	Gold sensor; -5.0 to 100.0 °C (23.0 to 212.0 °F); ±2000 mV
8	Smart probe, with RS485 connection	
zz	00 supplied with DIN connector (without cable). See page 15.56 (HI510 and HI520 accessories section) for patch cable ordering codes.	
	05, 10, 15, 25, 50 fixed cable length (in meters)	

### Dimensions

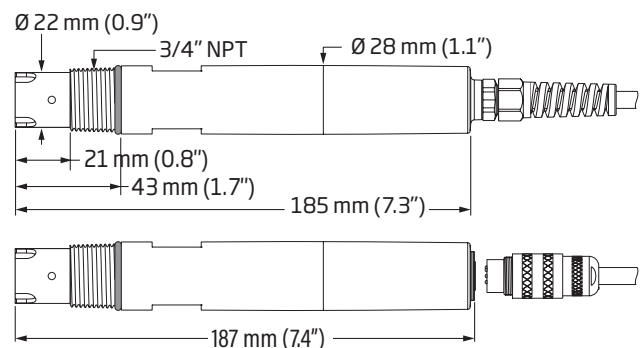

HI1006-18 • HI1006-38 • HI1006-48  
 HI1016-18 • HI1016-38 • HI1016-48

## pH and Temperature Industrial Smart Probes

*HI510 and HI520 Universal Process Controller compatible*

These industrial pH probes are intended for industrial process control when paired with the HI510 or HI520 Universal Process Controller.

- HI1006-18 and HI1016-18 series, designed for low conductivity or low-temperature process environments
- HI1006-38 and HI1016-38 series, designed for extended pH range or high-temperature process environments
- HI1006-48 and HI1016-48 series, designed for process environments where hydrofluoric acid is present

An integral temperature sensor measures water temperature and adjusts the probe signal over the specified temperature range.

The flat tip eliminates deposits that can foul the sensor and significantly reduces necessary maintenance.

The PVDF body material is easy to clean and disinfect, and resistant to most chemicals (e.g. solvents, sodium hypochlorite), ultraviolet light, and fungal growth.

Suitable for continuous measurement of pH required in applications such as urban wastewater treatment, industrial effluent treatment, and surface water monitoring, the probe (and accessories) can be installed directly in-line, immersed in a tank, or in a flow cell.

The probe is available with an integral connector that permits connections after installation.

Patch cables may be purchased separately to connect between the probe and controller up to 50 meters (164 ft).

- Rugged, chemically-resistant PVDF body
- Specialized glass sensor for fast stabilization and accurate results
- 3/4" NPT external thread for mounting
- Built-in temperature sensor for measurement and compensation
- Matching pin helps avoid typical problems caused by grounding loop current
- Digital probe stores model, firmware, serial number, and calibration information



Specifications	HI1006-18zz - example	
pH	Range	0.00 to 12.00 pH
	Resolution	0.1 pH or 0.01 pH
	Accuracy	±0.02 pH
	Calibration	Up to three-points (option to select from five standard buffers)
Temperature	Range	-5.0 to 80.0 °C (23.0 to 176.0 °F)
	Resolution	0.1 °C; 0.1 °F
	Accuracy	±0.5 °C; ±1.0 °F
	Calibration	Single point offset (controller setting)
Temperature Compensation	Automatic	0.0 to 80.0 °C (32.0 to 176.0 °F)
Temperature Source	Automatic (from Probe) Manual	
Body	PVDF	
Junction	PTFE	
Sensor	Body	LT glass
	Tip shape	flat, self-cleaning
	Diameter	22 mm (0.9")
	Insertion length	17 mm (0.7")
Maximum Pressure	6 bar (87 psi) at 25 °C (77 °F)	
Threaded Connection	3/4" NPT external thread for mounting	
Wetted Parts	Probe body	PVDF
	Sensor body	Glass
	O-ring	NBR
	Junction	PTFE
Matching pin	Titanium	
Protection Rating	IP68	
Cable Length	zz, see Ordering Information	

**PTFE junction:** Minimizing the potential for clogging and chemically resistant, PTFE is ideal for samples with high content of suspended solids or for high-pressure installations.

**Ceramic junction:** Porous chemically resistant plug that connects the reference electrode to the process electrically.

**LT glass:** Fast stabilization and accurate results at lower temperatures or lower ion content.

**HT glass:** Fast stabilization and accurate results at higher temperatures and over a larger pH range.

**HF glass:** Fast stabilization and accurate results for aggressive applications that have fluoride ions ( $F^- < 2$  g/L, temperature  $< 60$  °C, pH  $> 2$ ).

### Ordering Information

Each probe is supplied with quick reference guide with probe quality certificate.

**HI10** [x] [x] - [y] [8] [z] [z]

#### Choose your configuration:

xx	<b>06</b>	PTFE junction
	<b>16</b>	Ceramic junction
y	<b>1</b>	Low Temperature (LT) glass sensor, titanium matching pin -5.0 to 80.0 °C (23.0 to 176.0 °F) 0.00 to 12.00 pH
	<b>3</b>	High Temperature (HT) glass sensor, titanium matching pin 0.0 to 100.0 °C (32.0 to 212.0 °F) 0.00 to 14.00 pH
	<b>4</b>	Fluoride-resistant (HF) glass sensor, titanium matching pin -5.0 to 60.0 °C (23.0 to 140.0 °F) 0.00 to 10.00 pH
8	Smart probe, with RS485 connection	
zz	<b>00</b> supplied with DIN connector (without cable). See Accessories section for patch cable ordering codes.	
	<b>05, 10, 15, 25, 50</b> fixed cable length (in meters)	

Accessories	Part Number	Description
	<b>HI76510-05</b>	Patch cable, 5 m (16'5")
	<b>HI76510-10</b>	Patch cable, 10 m (32'9")
	<b>HI76510-15</b>	Patch cable, 15 m (49'2")
	<b>HI76510-25</b>	Patch cable, 25 m (82')
	<b>HI76510-50</b>	Patch cable, 50 m (164')

### Dimensions

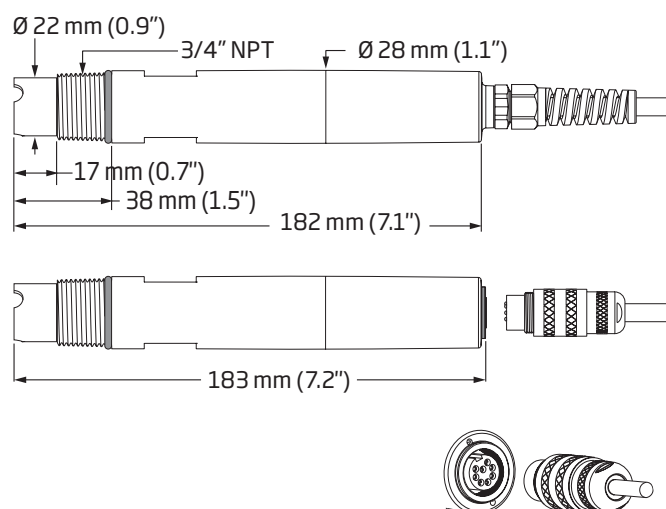

HI1026-1803

# pH and Temperature Industrial Smart Probe for Meat Applications

HI510 and HI520 Universal Process Controller compatible

To ensure consistent and safe meat products that comply with food safety regulations, pH levels must be monitored and maintained at a low value throughout the meat production process.

Hanna® industrial meat pH probe has been specifically designed to be tipped with a 49 mm (2") stainless steel blade. The blade features a 35 mm (1.4") cutout opening allowing the electrode to come in contact with the sample. Made of high-grade steel, the tip is rustproof and corrosion resistant and has a dual function: it both protects the glass pH electrode from breakage and is razor sharp for piercing into meat.

Intended for industrial use when paired with the HI510 or HI520 Universal Process Controller, the system allows for shared management of settings between controller and probe. The probe manages temperature compensation and buffer calibration settings whereas the controller manages application settings defined by process requirements.

Ideal for meat processing industry, including abattoirs, meat processing, and butchers.

- Chemically-resistant PP body
- Specialized glass sensor for fast stabilization and accurate results
- Built-in temperature sensor for measurement and compensation
- Matching pin helps avoid typical problems caused by grounding loop current
- Food grade, PVDF sensor sleeve that is easy to clean, disinfect, and resistant to most chemicals (e.g. solvents, sodium hypochlorite), ultraviolet light, and fungal growth
- Model, firmware, serial number, and calibration information are stored on the wired probe
- Stainless steel blade for meat processing
  - Made of high-grade stainless steel for long life
  - Razor sharp for piercing into meat
  - Protects glass pH electrode from breakage

## Dimensions

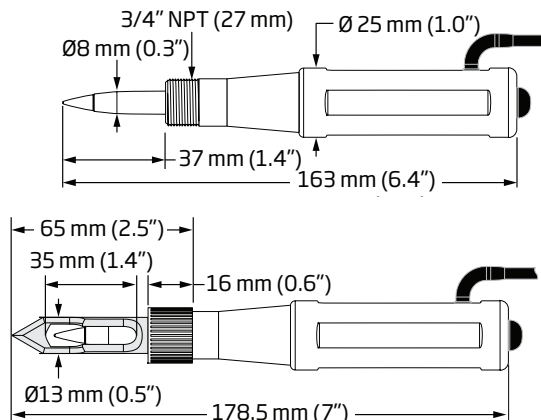

## HI1026 - 1803

### Ordering Information

HI1026-1803 is supplied with HI70300 Storage solution for pH and ORP electrodes, stainless steel blade, and quick reference guide with probe quality certificate.

### Specifications

pH	Range	0.00 to 12.00 pH
	Resolution	0.1 pH or 0.01 pH
	Accuracy	±0.02 pH
	Calibration	Up to three-points (option to select from five standard buffers)
Temperature	Range	0.0 to 50.0 °C (32.0 to 122.0 °F)
	Resolution	0.1 °C; 0.1 °F
	Accuracy	±0.5 °C; 1.0 °F
	Calibration	Single point offset (controller setting)
Temperature Compensation	Automatic	0.0 to 50.0 °C (32.0 to 122.0 °F)
Temperature Source	Automatic (from probe) Manual	
Body	PP	
Junction	Open	
Sensor	Body	LT glass
	Sleeve	PVDF
	Tip shape	Conic
	Tip size	6 x 10 mm (0.23 x 0.39")
	Diameter	8 mm (0.3")
	Insertion length	37 mm (1.4")
Reference Cell	Single Ag/AgCl	
Electrolyte	Viscolene	
Maximum Pressure	0.1 bar (1.45 psi)	
Threaded Size	M16 x 1.5	
Wetted Parts	Sensor sleeve	PVDF
	Sensor body	Glass
Protection Rating	IP68	
Cable Length	3 m (9'10")	



HI1126-1805

## pH and Temperature Industrial Smart Probe for Food Applications

HI510 and HI520 Universal Process Controller compatible

Designed as a versatile, general purpose electrode, HI1126-1805 is made of a sturdy, chemically resistant PP body with a conical tip probe that can be used in most food applications.

Intended for industrial use when paired with the HI510 or HI520 Universal Process Controller, the system allows for shared management of settings between controller and probe. The probe manages temperature compensation and buffer calibration settings whereas the controller manages application settings defined by process requirements.

- Chemically-resistant PP body
- Specialized glass sensor for fast stabilization and accurate results
- Built-in temperature sensor for measurement and compensation
- Matching pin helps avoid typical problems caused by grounding loop current
- Food grade, PVDF sensor sleeve that is easy to clean, disinfect, and resistant to most chemicals (e.g. solvents, sodium hypochlorite), ultraviolet light, and fungal growth
- Model, firmware, serial number, and calibration information are stored on the wired probe



### HI1126 - 1805

#### Ordering Information

HI1126-1805 is supplied with HI70300 Storage solution for pH and ORP electrodes, and quick reference guide with probe quality certificate.

#### Specifications

pH	Range	0.00 to 12.00 pH
	Resolution	0.1 pH or 0.01 pH
	Accuracy	±0.02 pH
	Calibration	Up to three-points (option to select from five standard buffers)
Temperature	Range	0.0 to 50.0 °C (32.0 to 122.0 °F)
	Resolution	0.1 °C; 0.1 °F
	Accuracy	±0.5 °C; 1.0 °F
	Calibration	Single point offset (controller setting)
Temperature Compensation	Automatic	0.0 to 50.0 °C (32.0 to 122.0 °F)
Temperature source	Automatic (from probe) Manual	
Body	PP	
Junction	Open	
Sensor	Body	LT glass
	Sleeve	PVDF
	Tip shape	Conic
	Tip size	6 x 10 mm (0.23 x 0.39")
	Diameter	8 mm (0.3")
	Insertion length	45 mm (1.8")
Reference Cell	Single Ag/AgCl	
Electrolyte	Viscolene	
Maximum Pressure	0.1 bar (1.45 psi)	
Wetted Parts	Sensor sleeve	PVDF
	Sensor body	Glass
Protection Rating	IP68	
Cable Length	5 m (16'5")	

#### Dimensions

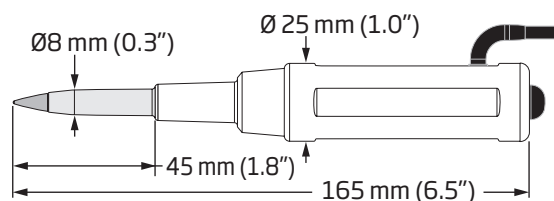

HI7630-28 Series • HI7630-48 Series

## Conductivity and Temperature Industrial Smart Probes

HI510 and HI520 Universal Process Controller compatible

HI7630-28 and HI7630-48 are conductivity and temperature probes designed to be paired with the HI510 or HI520 Universal Process Controller.

The probes are recommended for a wide range of water applications, from pure and ultrapure water (two-electrode series i.e. HI7630-28) to industrial process water (four-ring series i.e. HI7630-48).

Two-electrode probes can be calibrated using a standard with a value close to the measurement value whereas four-ring probes provide stable measurements over a wide measure range and do not require frequent calibrations.

An integral temperature sensor measures the process temperature and adjusts the measured conductivity to a reference temperature by applying specialized compensation standards:

- **Linear:** appropriate when it is assumed that the temperature coefficient of variation has the same value for all measurement temperatures.
- **Standard:** appropriate for high-purity water measurements and documented in ASTM Standard D5391-14. This setting should be used for resistivity measurements.
- **Natural:** appropriate for natural ground, well, or surface water (or water with similar composition) in accordance with ISO7888 standard.

The result is reliable electrolytic conductivity (EC), TDS (Total Dissolved Solids), resistivity, or Seawater Salinity in percent, psu, or ppt units.

The conductivity probes can be installed directly in-line, immersed in a tank, or in a flow cell, and are suited for continuous measurement of conductivity and associated parameters required in applications such as water treatment, drinking water, feed water condensate, or other clean water applications as well as sea water and surface-water monitoring.

The probe is available with an integral connector that permits connections after installation.

Patch cables may be purchased separately to connect between the probe and controller up to 50 meters (164 ft).

- Rugged, chemically-resistant PVDF body
- 3/4" NPT external thread for mounting
- 6 bar (87 psi) maximum pressure at 25 °C (77 °F)
- Digital probe stores model, firmware, serial number, and calibration information
- Linear, Natural, Standard, None temperature compensation modes



Two-electrode



Four-ring

## Specifications example HI7630-28zz

EC	Range	0.000 $\mu$ S/cm to 30.00 mS/cm*
	Resolution**	0.001, 0.01, 0.1 $\mu$ S/cm; 0.001, 0.01 mS/cm
	Accuracy	$\pm 2\%$ of reading or $\pm 0.050$ $\mu$ S/cm, whichever is greater
	Calibration	Standard: Automatic, two-point with standard solution Process: Single point
TDS	Range	0.000 mg/L to 15.00 g/L (TDS factor 0.5)*
	Resolution**	0.001, 0.01, 0.1 mg/L; 0.001, 0.01, 0.1 g/L
	Accuracy	$\pm 2\%$ of reading or $\pm 0.025$ mg/L, whichever is greater
	Calibration	Standard: Automatic, two-point with standard solution Process: Single point
Resistivity	Range	34 $\Omega$ •cm to 99.99 M $\Omega$ •cm*
	Resolution**	1 $\Omega$ •cm; 0.01, 0.1, 1 k $\Omega$ •cm; 0.01 M $\Omega$ •cm
Temperature	Range	0.0 to 50.0 °C (32.0 to 122.0 °F)
	Accuracy	$\pm 0.5$ °C; $\pm 1.0$ °F
	Calibration	Single point offset (controller setting)
Temperature Compensation Mode	Linear, Natural, Standard, None	
Temperature Source	Automatic (from probe) Manual	
Body	PVDF	
Sensor	Type	Two-electrode, concentric cylinder design
	Material	AISI 316 stainless steel
	Insulator	PVDF/Silicone
	Diameter	10 mm (0.4")
	Insertion length	23 mm (0.9")
Maximum Pressure	6 bar (87 psi)	
Threaded Connection	3/4" NPT external thread for insertion mounting	
Protection Rating	IP68	
Cable Length	zz, see Ordering Information	

\* Absolute values (not temperature compensated)  
\*\* Automatic ranging

## Specifications example HI7630-48zz

EC	Range	0.0 $\mu$ S/cm to 999.9 mS/cm*
	Resolution**	0.1 $\mu$ S/cm; 0.001, 0.01, 0.1 mS/cm
	Accuracy	$\pm 2\%$ of reading or $\pm 1$ $\mu$ S/cm, whichever is greater
	Calibration	Standard: Automatic, two-point with standard solution Process: Single point
TDS	Range	0.0 mg/L to 400.0 g/L (TDS factor 0.5)*
	Resolution**	0.1 mg/L; 0.001, 0.01, 0.1 g/L
	Accuracy	$\pm 2\%$ of reading or $\pm 0.5$ mg/L, whichever is greater
	Calibration	Standard: Automatic, two-point with standard solution Process: Single point
Resistivity	Range	1.0 $\Omega$ •cm to 9.99 M $\Omega$ •cm*
	Resolution**	0.1, 1 $\Omega$ •cm; 0.01, 0.1, 1 k $\Omega$ •cm; 0.01 M $\Omega$ •cm
	Calibration	Single point
Temperature	Range	0.0 to 100.0 °C (32.0 to 212.0 °F)
	Accuracy	$\pm 0.5$ °C; $\pm 1.0$ °F
	Calibration	Single point offset (controller setting)
Temperature Compensation Mode	Linear, Natural, Standard, None	
Temperature Source	Automatic (from probe) Manual	
Body	PVDF	
Sensor	Type	Four-ring, platinum
	Insulator	Glass
	Diameter	12 mm (0.5")
	Insertion length	50 mm (2")
Maximum Pressure	6 bar (87 psi)	
Threaded Connection	3/4" NPT external thread for insertion mounting	
Protection Rating	IP68	
Cable Length	zz, see Ordering Information	

\* Absolute values (not temperature compensated)  
\*\* Automatic ranging

**PTFE junction:** Minimizing the potential for clogging and chemically resistant, PTFE is ideal for samples with high content of suspended solids or for high-pressure installation.

**Ceramic junction:** Porous chemically resistant plug that connects the reference electrode to the process electrically.

**Platinum sensor:** Used in reducing processes such as chlorine dosing in pools and spas or chromate reduction.

**Gold sensor:** Used in oxidative processes such as cyanide oxidation in the mining industry.

## Ordering Information

Each probe is supplied with quick reference guide and probe quality certificate.

HI7630 - 

y
8
z
z

## Choose your configuration:

y	2	Two-electrode cell conductivity, AISI 316 stainless steel cell constant $k \approx 0.1/cm$
	4	Four-ring conductivity, platinum on glass cell constant $k \approx 1.0/cm$
8	Smart probe, with RS485 connection	
zz	00	supplied with DIN connector (without cable). See Accessories section for patch cable ordering codes.
	05, 10, 15, 25, 50	fixed cable length (in meters)

HI76510-05	Patch cable, 5 m (16'5")
HI76510-10	Patch cable, 10 m (32'9")
HI76510-15	Patch cable, 15 m (49'2")
HI76510-25	Patch cable, 25 m (82')
HI76510-50	Patch cable, 50 m (164')

## Accessories

## Dimensions two-electrode

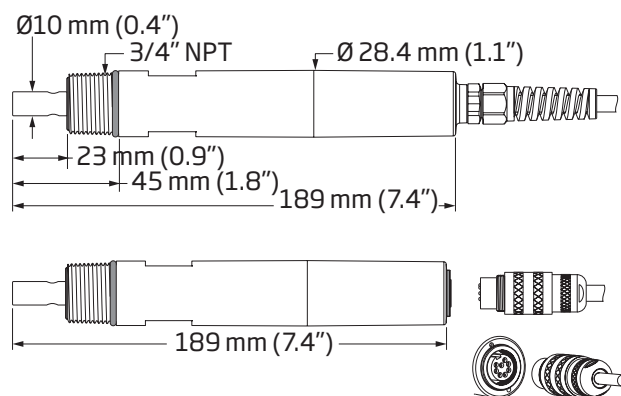

## Dimensions four-ring

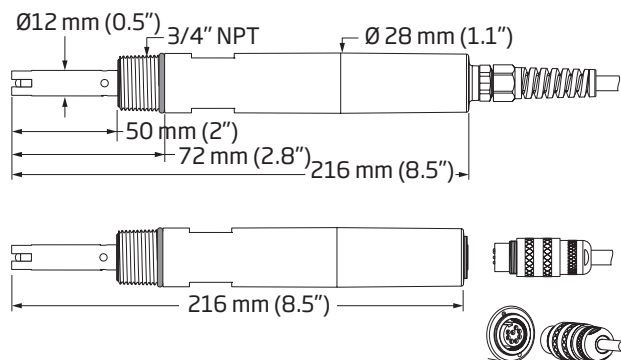

HI7640-18

## Galvanic Dissolved Oxygen Industrial Smart Probe

HI510 and HI520 Universal Process Controller compatible

The HI7640-18 is a galvanic-style oxygen probe designed for use with the Hanna Instruments® HI510 or HI520 process controller. The system is suited for continuous measurement of oxygen dissolved in water.

An integral temperature sensor measures water temperature and adjusts the probe signal over the specified temperature range. The result is reliable dissolved oxygen (DO) concentration or percent saturated measurements.

Suitable for control applications in municipal and industrial wastewater treatment, the probe can be submersed/immersed using the 3/4" NPT threads, or installed directly in-line or in a flow cell installation, using the lower sensor threads.

The probe is available with an integral connector that permits connections after installation.

Patch cables may be purchased separately to connect between the probe and controller up to 50 meters (164 ft).

- Galvanic probe with digital processing
- Simple membrane-cap replacement
- Large electrolyte reservoir provides longer service life
- Rugged, chemically-resistant PVDF body
- Built-in temperature sensor for measurement and DO compensation
- Digital probe stores model, firmware, serial number, and calibration information
- 3/4" NPT external thread for mounting
- 3 bar (43.5 psi) maximum pressure

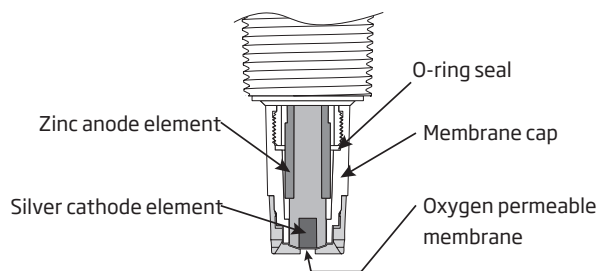

### The galvanic probe functions in the same manner as a battery.

The sensing elements consist of silver cathode and zinc anode, with a pretensioned membrane isolating the cell from the liquid being measured.

The refillable electrolyte reservoir holds ample electrolyte to support the reaction.

Oxygen diffuses through the membrane and is reduced on the surface of the cathode. This reaction generates a signal proportional to the oxygen concentration.



Specifications		example HI7640-18zz
Dissolved Oxygen	Range	0.00 to 50.00 mg/L (ppm) concentration 0.0 to 500.0 % saturation
	Resolution	0.01 mg/L (ppm) 0.1% saturation
	Accuracy	from 0.00 to 20.00 mg/L (ppm): $\pm 2\%$ of reading or $\pm 0.2$ mg/L (ppm), whichever is greater; from 20.00 to 50.00 mg/L (ppm): $\pm 6\%$ of reading from 0.0 to 200.0 % saturation: 2 % of reading or $\pm 2.0$ %, whichever is greater; from 200.0 to 500.0 % saturation: $\pm 6\%$ of reading
	Calibration	One or two points: at 100% and/or 0% or 8.26 mg/L and/or 0 mg/L in water-saturated air or zero-oxygen solution Single point process calibration: using value entered by the user in % saturation or mg/L
Temperature	Range	-5.0 to 50.0°C (23.0 to 122.0 °F)
	Resolution	0.1 °C; 0.1 °F
	Accuracy	$\pm 0.5$ °C; $\pm 1.0$ °F
	Calibration	Single point offset (controller setting)
Temperature Compensation	Automatic	
Temperature Source	Automatic (from probe) Manual	
Pressure Compensation	Automatic	420 to 850 mmHg
Salinity Compensation	Automatic	0 to 70 g/L (set manually)
Body	PVDF	
Sensor	Type	Galvanic cell
	Cathode	Silver (Ag)
	Anode	Zinc (Zn)
	Diameter	$\varnothing 17$ mm (0.7")
Insertion length	30 mm (1.2")	
Maximum Pressure	3 bar (43.5 psi) at 25 °C (77 °F)	
Threaded Connection	3/4" NPT external thread for insertion mounting	
Wetted Parts	Sensor body	PVDF
	Membrane cap	PEI and PTFE
	O-ring	NBR
Protection Rating	IP68	
Cable Length	zz, see Ordering Information	

## Ordering Information

Each probe is supplied with HI7042B Galvanic DO electrolyte solution, 30 mL (2 pcs.), HI7640-18A Replacement membrane cap and O-ring (5 pcs. of each), syringe and cone shaped plastic tip, electrolyte screw and fill hole O-ring (2 pcs. of each), protective probe cap, quick reference guide with probe quality certificate.

## HI7640 - 1 8 z z

### Choose your configuration:

1	Galvanic sensor
8	Smart probe, with RS485 connection
zz	<b>00</b> supplied with DIN connector (without cable). See Accessories section for patch cable ordering codes. <b>05, 10, 15, 25, 50</b> fixed cable length (in meters)

### Accessories

<b>HI7640-18A/P</b>	Replacement membrane cap (5 pcs.)
<b>HI7040L</b>	Zero oxygen solution set, 500 mL + 12 g
<b>HI7042B</b>	Galvanic DO electrolyte solution, 30 mL
<b>HI740226</b>	5 mL graduated syringe
<b>HI731350</b>	Plastic tip (25 pcs.)
<b>HI76510-05</b>	Patch cable, 5 m (16'5")
<b>HI76510-10</b>	Patch cable, 10 m (32'9")
<b>HI76510-15</b>	Patch cable, 15 m (49'2")
<b>HI76510-25</b>	Patch cable, 25 m (82')
<b>HI76510-50</b>	Patch cable, 50 m (164')

## Dimensions

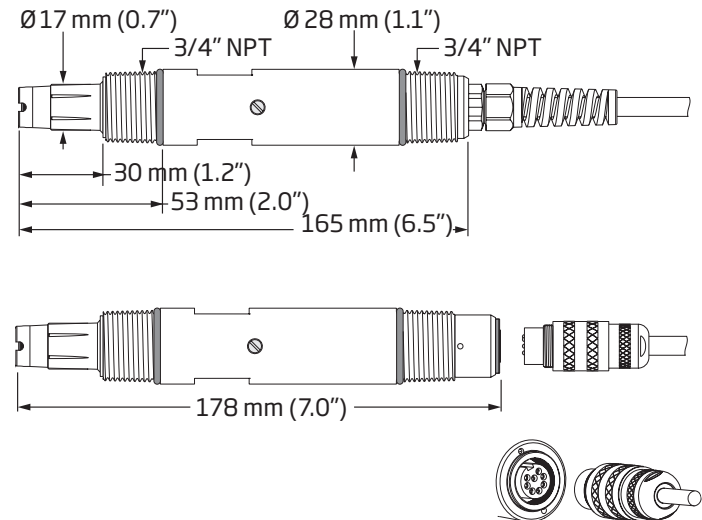

## Optical Dissolved Oxygen Industrial Smart Probe

*HI510 and HI520 Universal Process Controller compatible*

The HI7640-58 is an optical dissolved oxygen probe with HI764113-1 Smart Caps for measurement of dissolved oxygen.

The probe is designed to work with the Hanna Instruments® HI510 or HI520 process controller. When paired with the controller, the system provides accurate dissolved oxygen measurements auto-compensated for barometric pressure, salinity (set manually), and temperature.

Suitable for control applications in aeration basins, ponds, and tanks where optimizing oxygen transfer is a key element, the probe can be submersed/immersed in a tank using the 3/4" NPT threads, or installed in a flow cell using the lower sensor threads.

Several extension cables can be purchased separately to cover up to 50 meter (164 ft) distance between probe and controller.

### Principle of Operation

The method is based on the principle of fluorescence quenching and features an immobilized Pt- based luminophore that is excited by the light of a blue LED and emits a red light. Dissolved oxygen quenches this excitation. When there is no oxygen present, the lifetime of the signal is the greatest; as oxygen hits the sensing surface, the lifetime becomes shorter.

The intensity and lifetime are inversely proportional to the amount of oxygen present; as oxygen interacts with the luminophore it reduces the intensity and lifetime of the luminescence. The lifetime of the luminescence is measured by a photodetector, and is used to calculate the dissolved oxygen concentration. This is, in turn, reported by the controller as % saturation or mg/L of dissolved oxygen.

Over time, the sensor's optical components can age but are compensated for by using the reference signal to compensate the measuring path. As a result, the sensor provides accurate dissolved oxygen measurements over long periods of time without the need for frequent calibrations.

- Factory calibrated Smart Cap that stores data
- 3/4" NPT external thread at both ends
- Built-in temperature sensor for measurement
- Digital probe stores model, firmware, serial number, calibration information and Smart Cap data (serial number, installation date)
- Minimum maintenance (no electrolyte refill or membrane replacement)
- Measurement reliability independent of flow rate
- Reduced response time
- Stable readings even when oxygen concentration is low



Specifications

example HI7640-58zz

Dissolved Oxygen	Range	0.00 to 50.00 mg/L (ppm) concentration 0.0 to 500.0 % saturation
	Resolution	0.01 mg/L (ppm) 0.1% saturation
	Accuracy	from 0.00 to 20.00 mg/L (ppm): 1.5 % of reading or ±0.01 mg/L (ppm), whichever is greater; from 20.00 to 50.00 mg/L (ppm): ±5% of reading from 0.0 to 200.0 % saturation: ±1.5 % of reading or ±0.1 %, whichever is greater; from 200.0 to 500.0% saturation: ±5% of reading
	Calibration	One or two points: at 100% and/or 0% or 8.26 mg/L and/or 0 mg/L in water-saturated air or zero-oxygen solution  Single point process calibration: using value entered by the user in % saturation or mg/L
Temperature	Range	-5.0 to 50.0°C (23.0 to 122.0 °F)
	Resolution	0.1 °C; 0.1 °F
	Accuracy	±0.3 °C / ±0.5 °F
	Calibration	Single point offset (controller setting)
Temperature Compensation	Automatic	
Temperature source	Automatic (from probe) Manual	
Pressure Compensation	Automatic	420 to 850 mmHg
Salinity Compensation	Automatic	0 to 70 g/L (salinity factor set by user)
Body	ABS	
Sensor	Type	Optical DO
	Diameter	Ø 17 mm (0.7")
	Insertion length	43 mm (1.7")
Maximum Pressure	2 bar (29 psi) at 25 °C (77 °F)	
Threaded Connection	3/4" NPT external thread (both ends)	
Wetted Parts	Sensor body	PVDF
	Smart cap material	Polypropylene
	Dome-shaped membrane	PMMA
	O-ring	NBR
	Temperature contact	stainless steel
Protection Rating	IP68	
Cable Length	zz, see Ordering Information	

Dimensions

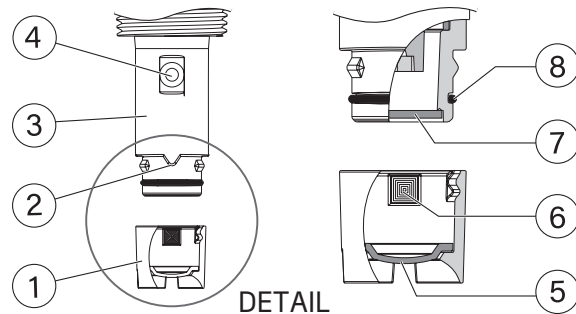
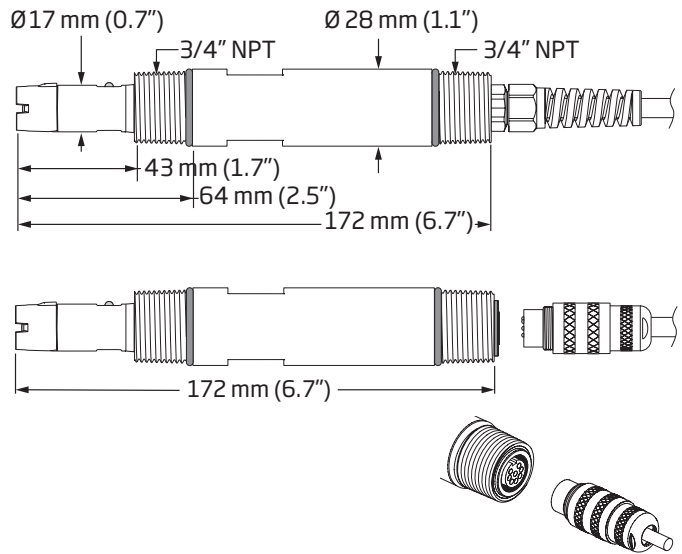

1. Smart Cap
2. Alignment Key
3. Probe Body
4. Temperature sensor
5. Embedded O<sub>2</sub> sensitive luminophore with rugged, insoluble black oxygen-permeable protective layer
6. Communication tag
7. Optical window
8. O-ring seal

Ordering Information

Each probe is supplied with HI764113-1 DO Smart Cap with O-ring, protective cap, calibration beaker, sachet with silicone grease, syringe, and quick reference guide with probe quality certificate.

**HI7640** - 5 8 z z

**Choose your configuration:**

5	Optical DO sensor
8	Smart probe, with RS485 connection
zz	<b>00</b> supplied with DIN connector (without cable). See Accessories section for patch cable ordering codes. <b>05, 10, 15, 25, 50</b> fixed cable length (in meters)

**Accessories**

<b>HI764113-1</b>	DO Smart Cap with O-ring
<b>HI76510-05</b>	Patch cable, 5 m (16'5")
<b>HI76510-10</b>	Patch cable, 10 m (32'9")
<b>HI76510-15</b>	Patch cable, 15 m (49'2")
<b>HI76510-25</b>	Patch cable, 25 m (82')
<b>HI76510-50</b>	Patch cable, 50 m (164')

Smart Cap





### Panel Mounted Controllers

Hanna panel mounted pH, ORP and conductivity controllers are designed to meet your most demanding process control requirements. Our controllers come equipped with a relay operating at a maximum of 2 A (240V). Where a direct electrode input is not suitable, the controller is available with a 4-20 mA input from a transmitter. This feature greatly improves the safety of your instrumentation and plant. Accurate measurements are displayed on a large LCD, enabling the operator to check the controller readings easily. These units have sophisticated, built-in, self-diagnostic functions that allow the operator to check whether a malfunction has originated in the instrument itself, or in the outside connection (electrode, transmitter or cables). This saves valuable time and money, particularly in the monitoring of critical processes. In the event of a malfunction, the operator can determine the origin and rectify the situation before any costly errors occur. This Self-Diagnostic Error Prevention System makes these process instruments superior to conventional controllers.

### Alarm Feature

Hanna controllers incorporate an alarm warning system. When the measured value of the meter is out of the user-specified range, the alarm is activated. When activated, the alarm contacts close, triggering the mechanism of your choice, whether a buzzer, light or any other electrical connection. The alarm feature is a necessity when the installation is in a remote location and corrective action must be taken immediately in the event of an out of range condition.

### Recorder Output

The ability to record data from the process you are monitoring greatly enhances process troubleshooting. By simply connecting a recorder to the controller's output terminals (choose between 0 to 20 mA or 4 to 20 mA according to your needs), users are able to acquire a hard copy for demonstrative or analytical purposes.

## Analog Process Controllers

### Low or High Impedance Input and Analog Inputs

Hanna pH and ORP controllers come in two different models to meet user requirements. These models, have a high impedance  $10^{12}$  Ohm direct input from an electrode, ideal for connections with a distance of up to 10 m (33'). However, if the distance is greater than 10 m (33') then a 4 to 20 mA transmitter should be used. The greater the distance between the controller and the sample, the greater the chance you have of line noise causing erroneous readings. Using a transmitter greatly enhances the input signal, thus allowing high accuracy at distances of up to 300 m (1000').

### Consent Feature

The consent contact allows you to be sure that the ORP dosing occurs only when the pH value is correct. This assures that the pH is within a specified range before any dosing of oxidizing or reducing agents occurs. This will prevent any overdosing of chemicals, a very important cost-effective feature in many applications, especially in pools, spas and hot tubs.

### Quality Construction

The controllers are housed in sturdy aluminum casings with ABS plastic front panels. The mounting brackets that are supplied with the meter, can be installed securely and quickly. When in operation, and with the transparent protective cover installed, the units comply with IP42 standards (see chart in section 20 for IP codes). The use of this design protects the unit from the conditions associated with industrial environments, ensuring a long and trouble-free operation.

### LED Indicators

The LEDs on the front panel light up to indicate the current operational mode. The LEDs also blink at different rates to indicate multiple modes occurring simultaneously. This feature allows the user to evaluate the controller from a distance and clearly read which mode it is in.





# Mechanical Dimensions for Panel Mounting



Analog Indicators and Controllers  
 HI8510 / HI8710 / HI8711 / HI8720 /  
 HI8931AN / HI8931BN / HI8931CN / HI8931DN / HI943500

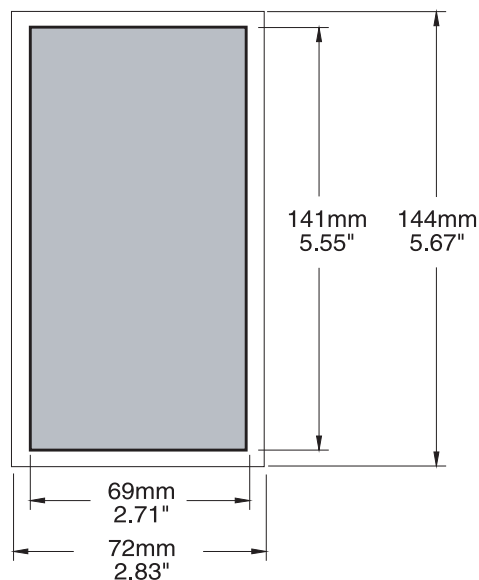

Front View  
 Dimensions show the cutout size for installation and also the outside dimensions of the instrument panel.

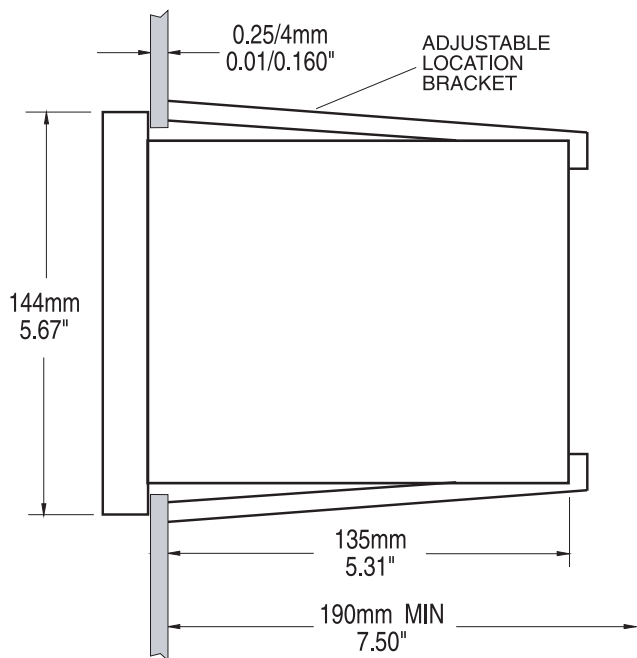

Side View  
 Adjustable location brackets allow the instrument to slide into the cutout and will hold the unit securely in place. 190 mm (7.50") is the minimum amount of room required to install the indicator with the cables connected.

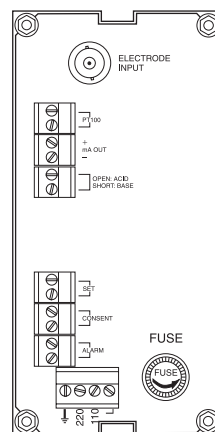

Rear View  
 Rear view of the HI8710 shows the typical electrical connections.

HI8510

# pH Analog Indicator

with Self Diagnostic Test

- ATC
  - Automatic temperature compensation Backlight
- Backlit, LCD display

HI8510 is ideal for monitoring pH in process control. It can provide highly accurate pH measurements and display values on the easy to read LCD. BNC input, amplified probe input and input from transmitter are supported.

Designed for easy and fast installation, the HI 8510 is provided with membrane keypads on the front panel, large display, and auto-diagnostic functions to check pH electrode and instrument status. These instruments also provide  $\pm 5V$  power output and input terminals for amplified electrodes.

A removable, transparent splash-proof cover protects the front panel.

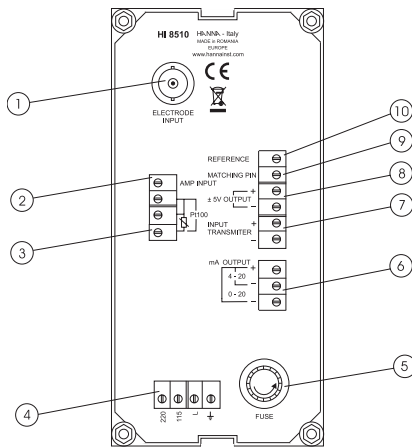

1. BNC socket for pH electrode
2. Input from amplified electrode
3. Connections for Pt100 temperature sensor
4. Power supply terminals
5. Fuse holder
6. Recorder output terminals
7. Connection to the transmitter
8. Power for amplified electrode
9. Connection for matching pin
10. Connection for reference electrode

## Specifications HI8510

Range	0.00 to 14.00 pH
Resolution	0.01 pH
Accuracy (@25°C/77°F)	$\pm 0.02$ pH (0 to 100 °C); $\pm 0.05$ pH (-20 to 0 °C); $\pm 0.5\%$ (input transmitter)
Input	high impedance $10^{12}$ Ohm; reference and matching pin inputs are available; 4-20 mA
Power Output	$\pm 5$ Vcc; 150 mA max load for amplified electrodes
Calibration	offset: $\pm 2$ pH with OFFSET trimmer; slope: 80 to 110% with SLOPE trimmer
Temperature Compensation	fixed or automatic with Pt100, from -20 to 100°C (-4 to 212°F)
Recorder Output	0-20 mA or 4-20 mA (isolated)
Backlight	continuous on
Power Supply	115 VAC $\pm 10\%$ or 230 VAC $\pm 10\%$ ; 50/60 Hz
Enclosure	flame retardant ABS body and front panel; transparent splash-proof front cover
Environment	-10 to 50°C (14 to 122°F); RH max 95% non-condensing
Panel Cutout	141 x 69 mm (5.6 x 2.7")
Weight	1 kg (2.2 lb.)

## Ordering Information

The **HI8510** is supplied complete with mounting brackets and instructions.

## Accessories

<b>HI8427</b>	pH / ORP electrode simulator
<b>HI931001</b>	pH / ORP electrode simulator with display
<b>HI8614N</b>	pH transmitter
<b>HI8614LN</b>	pH transmitter with display



HI8710

## pH Analog Controller

with Self-Diagnostic Test

- 0.2 to 3.00 pH alarm tolerance range
- Automatic temperature compensation
- Backlit, LCD display
- Removable, transparent splash-proof cover protects the front panel.

HI8710 is a panel mounted pH controller with self-diagnostic test capabilities. Users can set: the setpoint for acid or alkaline dosage, the tolerance of the setpoint before an alarm is activated, the dosage mode: automatic, continuous on or OFF and the over dosage control by setting the overtime dosage knob.

When used in conjunction with the HI8720 ORP controller, the ODCD\* function will ensure that the ORP dosage will start only when the pH level is correct.

“Overtime dosage” function with selection knob and jumper for disable on the rear panel. If the dosing relay remains continuously activated for more than selected dosing time the alarm relay is activated, the alarm LED is blinking and the dosing relay is deactivated.

\* ORP dosing consent device

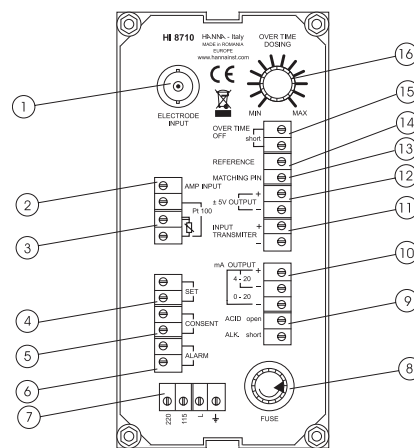

1. BNC socket for pH electrode
2. Input from amplified electrode
3. Connections for Pt100 temperature sensor
4. Connections for dosing pump
5. Reduc/Oxid dosage consent terminals
6. Alarm contacts
7. Power supply terminals
8. Fuse holder
9. Acid/Alkaline dosage selection terminals
10. Recorder output contacts
11. Connection to the transmitter
12. Power for amplified electrode
13. Connection for matching pin
14. Connection for reference electrode
15. Disable overtime connection
16. Overtime set knob (about 5 to 60 min)

### Specifications

### HI8710

Range	0.00 to 14.00 pH
Resolution	0.01 pH
Accuracy (@25°C/77°F)	±0.02 pH (0 to 100 °C); ±0.05 pH (-20 to 0 °C); ±0.5% (input from transmitter)
Input	high impedance 10 <sup>12</sup> Ohm; reference and matching pin inputs are available 4-20 mA
Power Output	±5 Vcc; 150 mA max load for amplified electrodes
Calibration	offset: ±2 pH with OFFSET trimmer; slope: 80 to 110% with SLOPE trimmer
Temperature Compensation	fixed or automatic with Pt100, from -20 to 100°C (-4 to 212°F)
Recorder Output	0-20 mA or 4-20 mA (isolated)
Set Point Relay	1, isolated, 2 A, max 240 V, resistive load, 1000000 strokes (not fuse protected)
Set Point Range	0.00 to 14.00 pH
Alarm Relay	1, isolated, 2 A, max 240 V, resistive load, 1000000 strokes (not fuse protected)
Alarm Range	0.2 to 3.00 pH
Consent Relay	1, isolated, 2 A, max 240 V, resistive load, 1000000 strokes (not fuse protected)
Dosing Control	OFF/AUTO/ON with selection switch
Over Dosing Control	adjustable, from 5 min to 60 min with knob or disable by wire strap - on rear panel
Backlight	continuous on
Power Supply	115 VAC ±10% or 230 VAC ±10%; 50/60 Hz
Enclosure	flame retardant ABS body and front panel; transparent splash-proof front cover
Environment	-10 to 50°C (14 to 122°F); RH max 95% non-condensing
Panel Cutout	141 x 69 mm (5.6 x 2.7")
Weight	1 kg (2.2 lb.)
<b>Ordering Information</b>	The <b>HI8710</b> is supplied complete with mounting brackets and instructions.
<b>Accessories</b>	<b>HI8427</b> pH / ORP electrode simulator
	<b>HI931001</b> pH / ORP electrode simulator with display
	<b>HI8614N</b> pH transmitter
	<b>HI8614LN</b> pH transmitter with display

HI8711

# pH Analog Controller

with Dual Output and Self-Diagnostic Test

- 0.2 to 3.00 pH alarm tolerance range
- Automatic temperature compensation
- Backlit, LCD display
- A removable, transparent splash-proof cover protects the front panel.

HI8711 allows the selection of two set points with two independent outputs for acid and alkaline dosages.

HI8711 accepts either a direct input from a pH or ORP electrode or from a transmitter through 4-20 mA input. The instrument also provides  $\pm 5V$  power output and input terminals for amplified electrodes. In addition, you can choose the output configuration for connecting a recorder or a PLC, between 0-20 or 4-20 mA.

The HI8711 incorporates adjustable overtime dosing protection from 5 to 60 minutes. If dosing exceeds selected time, the alarm will be triggered and the dosing contact will deactivate. This feature can be activated or deactivated.

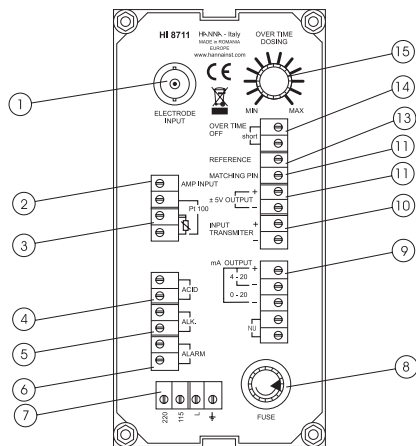

1. BNC socket for pH electrode
2. Input from amplified electrode
3. Connections for Pt100 temperature sensor
4. Connections for dosing pump for acid
5. Connections for dosing pump for base
6. Alarm contacts
7. Power supply terminals
8. Fuse holder
9. Recorder output contacts
10. Connections to the transmitter
11. Power for amplified electrode
12. Connection for matching pin
13. Connection for reference electrode
14. Disable overtime connection
15. Overtime set knob (about 5 to 60 min)



## Specifications HI8711

Range	0.00 to 14.00 pH
Resolution	0.01 pH
Accuracy (@25°C/77°F)	$\pm 0.02$ pH (0 to 100 °C); $\pm 0.05$ pH (-20 to 0 °C); $\pm 0.5\%$ (input from transmitter)
Input	high impedance $10^{12}$ Ohm; reference and matching pin inputs are available; 4-20 mA
Power Output	$\pm 5$ Vcc; 150 mA max load for amplified electrodes
Calibration	offset: $\pm 2$ pH with OFFSET trimmer; slope: 80 to 110% with SLOPE trimmer
Temperature Compensation	fixed or automatic with Pt100, from -20 to 100°C (-4 to 212°F)
Recorder Output	0-20 mA or 4-20 mA (isolated)
Set Point Relay	2, isolated, 2 A, max 240 V, resistive load, 1000000 strokes (not fuse protected)
Set Point Range	alk. set: from 0.00 to 14.00 pH; acid set: from 0.00 to 14.00 pH
Alarm Relay	1, isolated, 2 A, max 240 V, resistive load, 1000000 strokes (not fuse protected)
Alarm Range	0.2 to 3.00 pH
Dosing Control	OFF/AUTO/ON with selection switch
Over Dosing Control	adjustable, from 5 min to 60 min with knob or disable by wire strap - on rear panel
Backlight	continuous on
Power Supply	115 VAC $\pm 10\%$ or 230 VAC $\pm 10\%$ ; 50/60 Hz
Enclosure	flame retardant ABS body and front panel; transparent splash-proof front cover
Environment	-10 to 50°C (14 to 122°F); RH max 95% non-condensing
Panel Cutout	141 x 69 mm (5.6 x 2.7")
Weight	1 kg (2.2 lb.)
<b>Ordering Information</b>	The <b>HI8711</b> is supplied complete with mounting brackets and instructions.
<b>Accessories</b>	<b>HI8427</b> pH / ORP electrode simulator
	<b>HI931001</b> pH / ORP electrode simulator with display
	<b>HI8614N</b> pH transmitter
	<b>HI8614LN</b> pH transmitter with display



HI8720

## ORP Analog Controller

with Self-Diagnostic Test

- 10 to 300 mV alarm tolerance range
- Backlit, LCD display
- Removable, transparent splash-proof cover protects the front panel.

This instrument allows the selection of a set point for oxidizing or reducing dosage.

When used in conjunction with the HI8710 pH controller, the ODCD (ORP dosing consent device) function (featured by the HI8710) will ensure that the ORP dosage will start only when the pH level is correct.

Each model accepts either a direct input from an ORP electrode or from a transmitter through 4-20 mA input. The instrument also provides  $\pm 5V$  power output and input terminals for amplified electrodes.

Moreover, you can choose the output configuration for connecting a recorder or a PLC, between 0-20 or 4-20 mA.

### Specifications

### HI8720

Range	$\pm 1999$ mV
Resolution	1 mV
Accuracy (@25°C/77°F)	$\pm 5$ mV; $\pm 0.5\%$ (input from transmitter)
Input	high impedance $10^{12}$ Ohm; reference and matching pin inputs are available; 4-20 mA
Power Output	$\pm 5$ Vcc; 150 mA max load for amplified electrodes
Calibration	offset: $\pm 200$ mV with CAL trimmer;
Recorder Output	0-20 mA or 4-20 mA (isolated)
Set Point Relay	1, isolated, 2 A, max 240 V, resistive load, 1000000 strokes (not fuse protected)
Set Point Range	$\pm 1999$ mV
Alarm Relay	1, isolated, 2 A, max 240 V, resistive load, 1000000 strokes (not fuse protected)
Alarm Range	10 to 300 mV
Dosing Control	OFF/AUTO/ON with selection switch
Over Dosing Control	adjustable, from 5 min to 60 min with knob or disable by wire strap - on rear panel
Backlight	continuous on
Power Supply	115 VAC $\pm 10\%$ or 230 VAC $\pm 10\%$ ; 50/60 Hz
Enclosure	flame retardant ABS body and front panel; transparent splash-proof front cover
Environment	-10 to 50°C (14 to 122°F); RH max 95% non-condensing
Panel Cutout	141 x 69 mm (5.6 x 2.7")
Weight	1 kg (2.2 lb.)
<b>Ordering Information</b>	The <b>HI8720</b> is supplied complete with mounting brackets and instructions.
<b>Accessories</b>	<b>HI8427</b> pH / ORP electrode simulator
	<b>HI8615N</b> ORP transmitter
	<b>HI8615LN</b> ORP transmitter with display

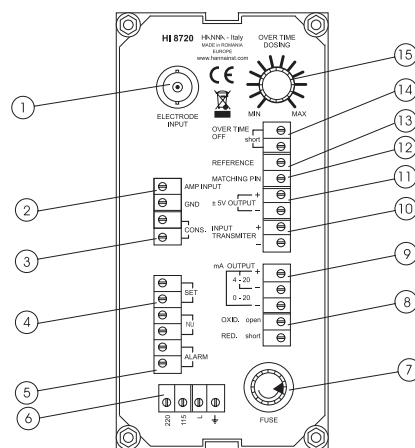

1. BNC socket for ORP electrode
2. Input from amplified electrode
3. Oxid/Reduc dosage consent terminals
4. Connections for dosing pump
5. Alarm contacts
6. Power supply terminals
7. Fuse holder
8. OXID/RED. dosage selection terminals
9. Recorder output contacts
10. Connections to the transmitter
11. Power for amplified electrode
12. Connection for matching pin
13. Connection for reference electrode
14. Disable overtime connection
15. Overtime set knob (about 5 to 60 min)

HI8512

# ORP Analog Indicator

with Self-Diagnostic Test

- Auto-diagnostic tests for electrode and instrument status
- Backlit, LCD display
- A removable, transparent splash-proof cover protects the front panel.

Built-in autodiagnostic functions to enable the user to check and troubleshoot any malfunctions. The functions are made via front panel keys to isolate the cause of malfunction whether it is due to pH electrode contamination, internal offset circuit or the amplifier circuit.

To enhance troubleshooting and the ability to record data while monitoring, simply attach a recording device to the instrument's 4 to 20 mA output contacts, conveniently located on the front panel, to obtain a copy of the results on demand.

HI8512 is provided with membrane keypads on the front panel, large display, and auto-diagnostic functions to check pH electrode and instrument status.

HI8412 allows for quick and easy connection to any ORP meter or transmitter.

LED indicators identify the controller mode.

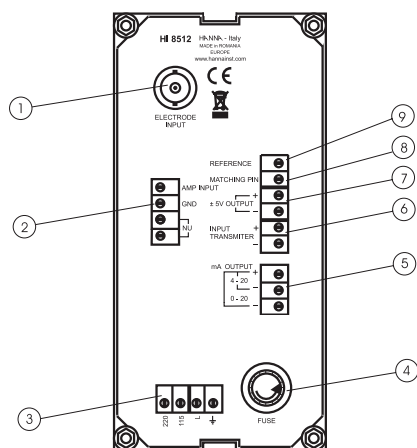

1. BNC socket for ORP electrode
2. Input from amplified electrode
3. Power supply terminals
4. Fuse holder
5. Recorder output terminals
6. Connection to the transmitter
7. Power for amplified electrode
8. Connection for matching pin
9. Connection for reference electrode

## Specifications

## HI8512

Range	±1000 mV
Resolution	1 mV
Accuracy (@25°C/77°F)	±5 mV; ±0.5% (input from transmitter)
Input	high impedance 10 <sup>12</sup> Ohm; reference and matching pin inputs are available; 4-20 mA
Power Output	±5 Vcc; 150 mA max load for amplified electrodes
Calibration	Offset: ±200 mV with CAL trimmer
Recorder Output	0-20 mA or 4-20 mA (isolated)
Backlight	continuous on
Power Supply	115 or 230 Vac; 60/50 Hz
Enclosure	flame retardant ABS body and front panel; transparent splash-proof front cover
Environment	-10 to 50°C (14 to 122°F); RH max 95% non-condensing
Panel Cutout	141 x 69 mm (5.6 x 2.7")
Weight	1 kg (2.2 lb.)
<b>Ordering Information</b>	The <b>HI8512</b> is supplied complete with mounting brackets and instructions.
<b>Accessories</b>	<b>HI8427</b> pH / ORP electrode simulator
	<b>HI8615N</b> ORP transmitter
	<b>HI8615LN</b> ORP transmitter with display



HI8931AN · HI8931BN  
HI8931CN · HI8931DN

## EC Analog Controller

with Input from Probe or Transmitter

- Automatic temperature compensation
- Backlit, LCD display
- Removable, transparent splash-proof cover protects the front panel.

HI8931 is a panel mounted conductivity controller designed for simplicity of use. For in-line applications, use the HI7635 probe, while for tanks the HI7638 with external threads is recommended. These probes are provided with a built-in NTC sensor for temperature compensated conductivity measurements.

HI8931 also features a direct connection up to 20 m (67'), without needing to amplify the signal to the conductivity probe.

Using the HI8931 in conjunction with a 4-20 mA output transmitter (HI8936 or HI8936L series) will assure a strong, interference free signal at distances up to 300 meters (1000').

Specifications	HI8931AN	HI8931BN	HI8931CN	HI8931DN
Range	0.0 to 199.9 mS/cm	0.00 to 19.99 mS/cm	0 to 1999 $\mu$ S/cm	0.0 to 199.9 $\mu$ S/cm
Resolution	0.1 mS/cm	0.01 mS/cm	1 $\mu$ S/cm	0.1 $\mu$ S/cm
Accuracy (@25°C/77°F)	±2% F.S. (excluding probe error)	±2% F.S. (excluding probe error)	±2% F.S. (excluding probe error)	±2% F.S. (excluding probe error)
Input from Transmitter	HI8936A / AL	HI8936B / BL	HI8936C / CL	HI8936D / DL
Set Point Range	0.0 to 199.9 mS/cm	0.00 to 19.99 mS/cm	0 to 1999 $\mu$ S/cm	0.0 to 199.9 $\mu$ S/cm
Alarm Range	0.0 mS and 100.0 mS	0.00 mS and 10.00 mS	0 $\mu$ S and 1000 $\mu$ S	0.0 $\mu$ S and 100.0 $\mu$ S
Temp. Compensation	automatic, 0 to 60°C with $\beta=2\%/^{\circ}\text{C}$ ; see also transmitter HI8936			
Inputs	DIN (probe) or 4-20 mA (transmitter)			
Conductivity Probe	HI7635 for in-line applications or HI7638 for tanks (not included)			
Calibration	manual, two point, through offset and slope trimmers			
Recorder Output	0 to 20 mA or 4 to 20 mA (isolated)			
Set Point and Alarm Relay	1, Isolated, 2A, max. 240V, resistive load, 1,000,000 strokes			
Dosing Control	OFF/AUTO/ON with selection switch			
Over Dosing Control	adjustable, from 5 min to 60 min with knob or disable by wire strap - on rear panel			
Backlight	continuous on			
Power Supply	115 VAC $\pm 10\%$ or 230 VAC $\pm 10\%$ ; 50/60 Hz			
Enclosure	flame retardant ABS body and front panel; transparent splash-proof front cover			
Environment	-10 to 50°C (14 to 122°F); RH max 95% non-condensing			
Panel Cutout	141 x 69 mm (5.6 x 2.7")			
Weight	1 kg (2.2 lbs.)			
Ordering Information	The <b>HI8931</b> series is supplied with mounting brackets and instructions.			

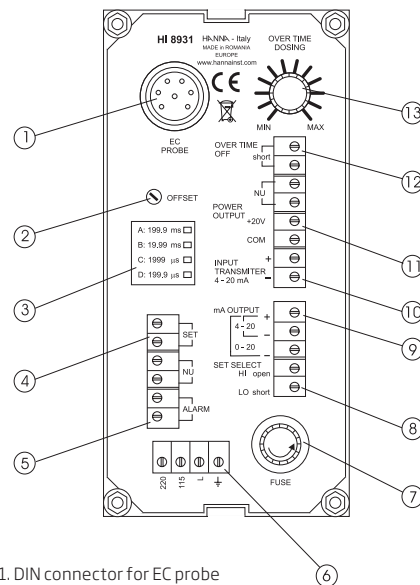

1. DIN connector for EC probe
2. Trimmer for offset calibration
3. Label with marked A, B, C or D instrument type
4. SET terminals for connection to a dosing pump
5. ALARM terminals for connection to an external alarm device
6. Power supply terminals
7. Fuse holder
8. SET SELECT terminals for reverse control operation
9. mA OUTPUT terminals for connection to a recorder
10. mA INPUT terminals for connection to a conductivity transmitter
11. POWER OUTPUT terminals (+20 V and COM) for connection to a conductivity transmitter (HI 8936)
12. Disable overtime dosing connection
13. Overtime dosing set knob (about 5 to 60 min)

HI943500A · HI943500B  
HI943500C · HI943500D

# EC Analog Controller

with Direct Input from Potentiometric Probe

- Automatic temperature compensation
- Backlit, LCD display

These controllers allow direct connection of a potentiometric conductivity probe (HI7638) with a cable up to 20 m long, without needing a transmitter to amplify the signal.

The output configuration for connecting a recorder or a PLC can be chosen between 0-20 or 4-20 mA.

The LED on the front panel indicates the operating status of the controller.

The Automatic Temperature Compensation (ATC) is performed directly by the HI7638 probe with built-in temperature sensor.

A removable, transparent splash-proof cover protects the front panel.

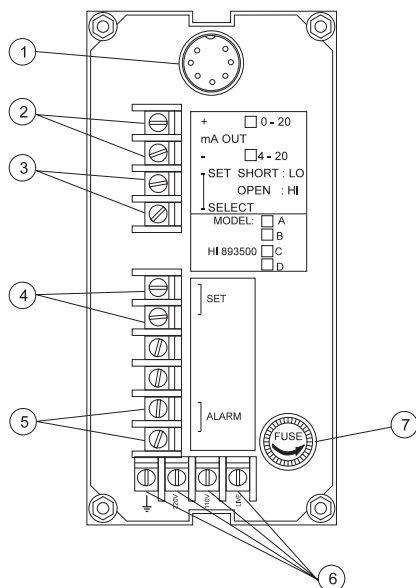

1. DIN connector for conductivity probe
2. mA OUTPUT terminals for connection to a recorder
3. SET SELECT terminals for reverse control operation
4. SET terminals for connection to a dosing pump
5. ALARM terminals for connection to an external alarm device
6. Power supply terminals
7. Fuse holder

Specifications	HI943500A	HI943500B	HI943500C	HI943500D
Range	0.0 to 199.9 mS/cm	0.00 to 19.99 mS/cm	0 to 1999 µS/cm	0.0 to 199.9 µS/cm
Resolution	0.1 mS/cm	0.01 mS/cm	1 µS/cm	0.1 µS/cm
Accuracy (@25°C/77°F)	±2% F.S.			
Calibration	manual, two point, through offset and slope trimmers			
Temperature Compensation	automatic, 0 to 60°C (32 to 140°F), with β=2%/°C			
Recorder Output	4-20 mA (isolated)			
Set Point Relay	1, isolated, 2A, max. 240 V, resistive load, 1,000,000 strokes			
Alarm Relay	1, isolated, 2A, max. 240 V, resistive load, 1,000,000 strokes			
Power Supply	115 or 230 VAC ±10% (user selectable); 50/60 Hz			
Enclosure	flame retardant ABS body and front panel; transparent splash-proof front cover			
Environment	-10 to 50°C (14 to 122°F); RH max 95%			
Panel Cutout	141 x 69 mm (5.6 x 2.7")			
Weight	1 kg (2.2 lb.)			
<b>Ordering Information</b>	The <b>HI943500</b> series is supplied complete with mounting brackets and instructions.			
<b>Probes</b>	<b>HI7638</b>	PEI/glass body, 75 mm conductivity probe with internal temperature sensor and 3/8" NPT thread (immersion)		





HI8410

## Dissolved Oxygen Controller

with Extended Range and Analog Output

- 0.5 to 5.0 mg/L (ppm) O<sub>2</sub> alarm range
- Automatic temperature compensation

The HI8410 is a panel mounted dissolved oxygen controller that is used to maintain and monitor the concentration of DO in a wide range of industrial process applications. The HI8410 uses a Galvanic probe that typically requires less maintenance than a Polarographic style making it ideal for long term monitoring.

The set point for controlling the activation of a relay is adjusted manually by the user. An alarm relay is also manually adjustable and is based upon a tolerance from the programmed setpoint. This controller features single set point calibration in zero oxygen solution.

The D.O. probe is provided with a membrane covering the galvanic sensor and a built-in thermistor for temperature measurement and compensation.

### Specifications

### HI8410

Range	0.0 to 50.0 mg/L (ppm) O <sub>2</sub> ; 0 to 600 % O <sub>2</sub> ; -5.0 to 50.0°C						
Resolution	0.1 mg/L (ppm) or 1% (O <sub>2</sub> ) / 0.1°C						
Accuracy (@25°C/77°F)	±1% of reading (O <sub>2</sub> ) / ±0.2°C						
Calibration	manual, one point, in saturated air						
Temp. Compensation	automatic, from -5 to 50°C (23 to 122 °F)						
Salinity Compensation	0 to 51 g/L (resolution 1 g/L)						
Probe (not included)	HI76410/4 with 4 m (13.1') cable or HI76410/10 with 10 m (32.8') cable						
Recorder Output	0 to 20 mA or 4 to 20 mA (isolated)						
Set point and Alarm Relay	1, isolated, 2A, max. 240V, resistive load, 1,000,000 strokes						
Set point Range	5 to 600 % O <sub>2</sub> ; 0.5 to 50.0 mg/L (ppm) O <sub>2</sub>						
Alarm Range	0.5 to 5.0 mg/L (ppm) O <sub>2</sub>						
Hysteresis Range	0.5 to 2.4 mg/L (ppm) O <sub>2</sub>						
Dosing Control	OFF/AUTO/ON with selection switch						
Over Dosing Control	adjustable, from 5 min to 60 min with knob or disable by wire strap - on rear panel						
Backlight	continuous on						
Power Supply	115 VAC ±10% or 230 VAC ±10%; 50/60 Hz						
Enclosure	flame retardant ABS body and front panel; transparent splash-proof front cover						
Environment	-10 to 50°C (14 to 122°F); RH max 95% non-condensing						
Panel Cutout	141 x 69 mm (5.6 x 2.7")						
Weight	1 kg (2.2 lb.)						
<b>Ordering Information</b>	The <b>HI8410</b> is supplied complete with mounting brackets and instructions.						
<b>Probes and Accessories</b>	<table border="1"> <tbody> <tr> <td><b>HI76410/4</b></td> <td>Galvanic DO probe (fixed) with internal temperature sensor, DIN connector and 4 m (13.1') cable</td> </tr> <tr> <td><b>HI76410/10</b></td> <td>Galvanic DO probe (fixed) with internal temperature sensor, DINconnector and 10 m (32.8') cable</td> </tr> <tr> <td><b>HI76410A</b></td> <td>Spare membranes for HI76410</td> </tr> </tbody> </table>	<b>HI76410/4</b>	Galvanic DO probe (fixed) with internal temperature sensor, DIN connector and 4 m (13.1') cable	<b>HI76410/10</b>	Galvanic DO probe (fixed) with internal temperature sensor, DINconnector and 10 m (32.8') cable	<b>HI76410A</b>	Spare membranes for HI76410
<b>HI76410/4</b>	Galvanic DO probe (fixed) with internal temperature sensor, DIN connector and 4 m (13.1') cable						
<b>HI76410/10</b>	Galvanic DO probe (fixed) with internal temperature sensor, DINconnector and 10 m (32.8') cable						
<b>HI76410A</b>	Spare membranes for HI76410						

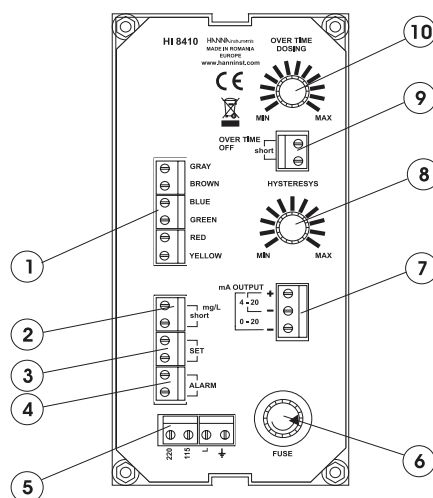

1. DO probe connection terminals
2. Range selection: mg/L or % DO
3. SET terminals for connection to a dosing pump
4. ALARM terminals for connection to an external alarm device
5. Power supply terminals
6. Fuse holder
7. mA OUTPUT terminals for connection to a recorder
8. Hysteresis set knob (0.5 to 2.4 mg/L)
9. Disable overtime dosing connection
10. Overtime dosing set knob (about 5 to 60 min)



## BL mini controllers are the perfect solution for water analysis and control.

### pH Mini Controllers

Monitoring and controlling pH in water conditioning and industrial applications is essential for water quality and maintaining infrastructure (piping and equipment). In the case of industrial effluent, neutralization of acidic waste is vital for environmental safety and public health. In boiler feed water conditioning, a pH of 8.5 is necessary to prevent scaling and corrosion of critical components. Maintaining a pH of 7.4 is fundamental for proper and efficient sanitization in swimming pools and spas. The efficacy of sanitizers, such as chlorine, is dependent on a controlled pH value.

### ORP Mini Controllers

ORP (oxidation reduction potential) is a dependable and consistent indicator of sanitizing effectiveness of a pool, spa, or water treatment. As oxidizers, chlorine, peroxide, and ozone are added, the ORP value increases, providing a clear indication of the cleansing power of the water. Typically, an ORP value of 650 to 700 mV at a pH of 7.2 indicates that water is properly treated and all harmful bacteria are killed in less than 1 second. ORP is also essential in chemical processing where reducing agents are used and a negative ORP value indicates proper neutralization.

### Conductivity Mini Controllers

In water, an increase in conductivity indicates an increase in water hardness and a decrease in purity. Conductivity monitoring and control is essential in reducing water hardness and maintaining water quality. Water with a conductivity value of 0 to 140  $\mu\text{S}/\text{cm}$  is considered "very

soft," while 640 to 840  $\mu\text{S}/\text{cm}$  is considered "hard" water. An increase in conductivity indicates an increase in the amount of damaging dissolved solids (salts) present in water. Conductivity monitoring and control is essential in industrial applications such as feed water control, blow down activation in cooling towers and water management. In these applications, high conductivity will cause scaling and corrosion of piping and damage to critical components.

### TDS Mini Controllers

A TDS (total dissolved solids) measurement is an important indicator of water quality. An increase in TDS indicates an increase in the amount of dissolved solids (salts) present in the water. TDS monitoring and control is imperative in industrial applications such as feed water control, blow down activation in cooling towers and water management. In these applications, high TDS will cause scaling and corrosion of piping and damage to critical components.

A TDS measurement is also an important indicator of the effectiveness of water conditioning. An increase in TDS indicates an increase in water hardness and a decrease in purity. This will affect the quality of drinking water, feed water, and rinse water. TDS monitoring and control is crucial in reducing water hardness and maintaining water quality and usability.

### Resistivity Mini Controller

Resistivity, measured in  $\Omega \cdot \text{M}$ , is the optimal way to measure the quality of water produced by high purity systems, such as reverse osmosis (RO) systems and water conditioning equipment. As resistivity is the inverse of conductivity, it provides a more accurate characterization of water with very low conductive ability. As filter systems become less effective, the resistivity value will decrease, indicating a need for maintenance and/or replacement of filters and critical components. Properly functioning RO and water conditioning systems will consistently produce water with resistivity readings in the range of 16 to 18  $\text{M}\Omega \cdot \text{cm}$ .

**Any system can be cost effectively monitored 24/7**



# Hanna Mini Controllers

BL Series Mechanical Dimensions

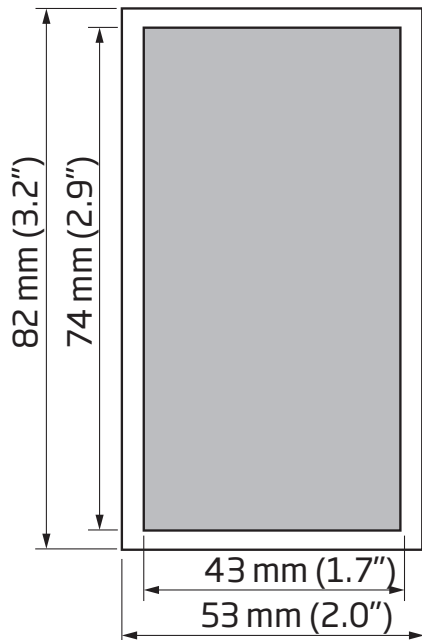

## Front View

Front view of the panel-mounted units.

Dimensions show the cutout size for installation and also the outside dimensions of the panel.

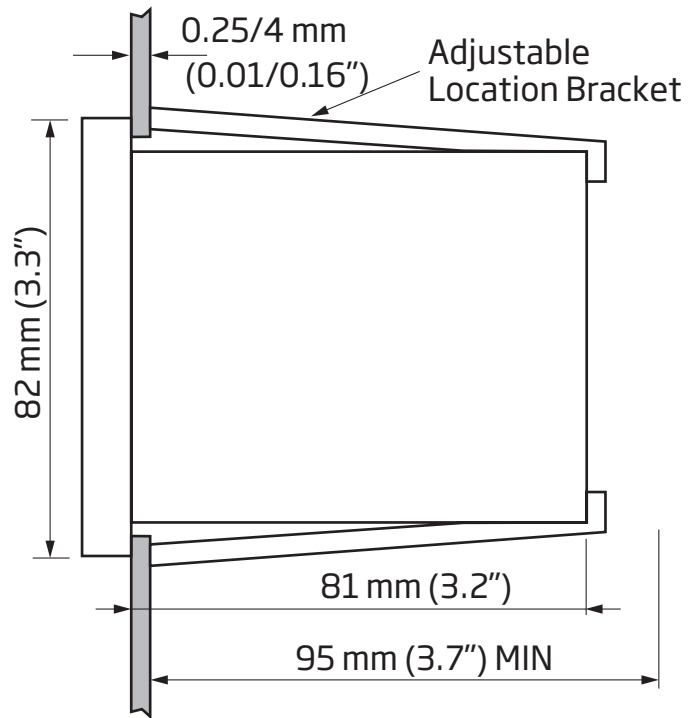

## Side View

Side view of panel-mounted controllers.

130 or 87 mm (depending on model) is the minimum amount of room required to install the unit with all wiring.

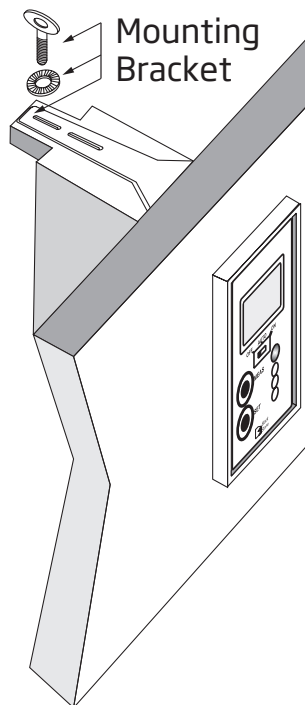

## Top View

Adjustable location brackets allow the controller to slide into the cutout and will hold the unit securely in place.

BL981411

## pH Mini Controller

- Large Clear LCD
- Fire Retardant Casing
- BNC Connection
- Splash-Resistant Cover

The BL981411 is a compact, pH process controller designed for applications where space and/or cost are important. The device contains a high impedance pH input and may be used with any pH electrode with a standard BNC connector. Users may choose from automatic or manual dosing modes allowing for easy maintenance and troubleshooting.

### Adjustable Dosing Relay

The BL981411 features a dosing relay which may be configured to dose above or below a user programmable pH setpoint.

### Selectable Overdose Protection

The mini controller may be programmed to deactivate a valve, pump, or connected device if its activation continues over a selected time; adjustable from 5 to 30 minutes.

### Relay Control Override

With the flick of a switch the mini controller's relay can be disabled (OFF), placed in control (AUTO), or be activated for manual operation (ON) which is useful for priming a dosing pump.

### Fuse Protected Dosing Contacts

The relay dosing contact is rated for up to a 2A load and is fuse protected.

### Easy Peripheral Connection

Quick-connect terminal blocks provide for easy connection to power, communication, dosing control, or sensors.

### Matching Pin Connection

A built-in matching pin helps protect the sensor from ground loop effects that may lead to erratic readings or system damage.



Specifications	BL981411
Range	0.0 to 14.0 pH
Resolution	0.1 pH
Accuracy (@25°C/77°F)	±0.2 pH
Calibration	manual, through CAL (offset) trimmer
Dosing Relay	maximum 2A (fuse protected), 250 Vac, 30 VDC
Dosing Selection	acid or alkaline contact open=acid dosage=relay ON if measurement > setpoint contact closed=alkaline dosage=relay ON if measurement < setpoint
Setpoint	adjustable from 0 to 14 pH
Overtime	adjustable, from 5 to approximately 30 minutes
Input Impedance	10 <sup>12</sup> Ohm
Power Supply	BL981411-0: 12 VDC adapter (included); BL981411-1: 115/230 VAC; 50/60Hz
Dimensions	83 x 53 x 99 mm (3.3 x 2.1 x 3.9")
Weight	BL981411-0: 200 g (7.1 oz.); BL981411-1: 300 g (10.6 oz.)
Ordering Information	<b>BL981411-0</b> (12 VDC) and <b>BL981411-1</b> (115/230 VAC) are supplied with mounting brackets, transparent cover and instruction manual.
Recommended Probe	<b>HI1001</b> PVDF body pH electrode with 1/2" NPT thread, BNC connector and 3 m (9.8') cable for continuous flow-thru monitoring (not included).



BL931700

## pH Mini Controller

with 4-20 mA Recorder Output

- Large Clear LCD
- Fire Retardant Casing
- BNC Connection
- Splash-Resistant Cover

The BL931700 is a compact single setpoint pH controller designed for applications where space and/or cost are important. Users may choose from automatic or manual dosing modes allowing for easy maintenance and troubleshooting. The device contains a high impedance pH input and may be used with any pH electrode that has a standard BNC connector.

### Enhanced Accuracy & Precision

The BL931700 model offers a manual two-point calibration with pH values displayed out to two decimal places.

### External Disabling Feature

A normally open contact may connect to a level controller or flow monitor. This safety feature may be used to prevent continuous dosing in the event of specific or undesired system conditions.

### Adjustable Dosing Relay

The BL931700 features a dosing relay which may be configured to dose above or below a user programmable pH setpoint.

### Selectable Overdose Protection

The mini controller may be programmed to deactivate a valve, pump, or connected device if its activation continues over a selected time; adjustable from 5 to 30 minutes.

### Relay Control Override

With the flick of a switch the mini controller's relay can be disabled (OFF), placed in control (AUTO), or be activated for manual operation (ON) which is useful for priming a dosing pump.

### Analog Output Communication

The BL931700 features a 4 - 20 mA analog output for connection to a data logger, chart recorder, or other device.

### Matching Pin Connection

A built-in matching pin helps protect the sensor from ground loop effects that may lead to erratic readings or system damage.

### Fuse Protected Dosing Contacts

The relay dosing contact is rated for up to a 2A load and is fuse protected.

### Easy Peripheral Connection

Quick-connect terminal blocks provide for easy connection to power, communication, dosing control, or sensors.

Specifications	BL931700
Range	0.00 to 14.00 pH
Resolution	0.01 pH
Accuracy (@25°C/77°F)	±0.02 pH
Calibration	manual, through offset and slope trimmers
Dosing Relay	maximum 2A (fuse protected), 250 Vac, 30 VDC
Dosing Selection	acid or alkaline contact open=acid dosage=relay ON if measurement > setpoint contact closed=alkaline dosage=relay ON if measurement < setpoint
Setpoint	adjustable from 0 to 14 pH
Overtime	adjustable, from 5 to approximately 30 minutes
Recorder Output	4 to 20 mA, accuracy ±0.20 mA, 500 Ω maximum load
Input Impedance	10 <sup>12</sup> Ohm
Power Supply	BL931700-0: 12 VDC adapter (included); BL931700-1: 115/230 VAC; 50/60Hz
Dimensions	83 x 53 x 99 mm (3.3 x 2.1 x 3.9")
Weight	BL931700-0: 200 g (7.1 oz.); BL931700-1: 300 g (10.6 oz.)
Ordering Information	<b>BL931700-0</b> (12 VDC) and <b>BL931700-1</b> (115/230 VAC) are supplied with mounting brackets, transparent cover and instruction manual.
Recommended Probe	<b>HI1001</b> PVDF body pH electrode with 1/2" NPT thread, BNC connector and 3 m (9.8') cable for continuous flow-thru monitoring (not included).

BL982411

# ORP Mini Controller

- Large Clear LCD
- Fire Retardant Casing
- BNC Connection
- Splash-Resistant Cover

The BL982411 is a compact, easy to handle, efficient, ORP process controller designed for applications where space or cost is important. The device may be used with any ORP electrode with a standard BNC connector. Users may choose from automatic or manual dosing modes allowing for easy maintenance and troubleshooting.

## Adjustable Dosing Relay

The BL982411 features a dosing relay which may be configured to dose above or below a user programmable mV setpoint.

## Selectable Overdose Protection

The mini controller may be programmed to deactivate a valve, pump, or connected device if its activation continues over a selected time; adjustable from 5 to 30 minutes.

## Relay Control Override

With the flick of a switch the mini controller's relay can be disabled (OFF), placed in control (AUTO), or be activated for manual operation (ON) which is useful for priming a dosing pump.

## Fuse Protected Dosing Contacts

The relay dosing contact is rated for up to a 2A load and is fuse protected.

## Easy Peripheral Connection

Quick-connect terminal blocks provide for easy connection to power, communication, dosing control, or sensors.

## Matching Pin Connection

A built-in matching pin helps protect the sensor from ground loop effects that may lead to erratic readings or system damage.



Specifications	BL982411
Range	0 to 1000 mV
Resolution	1 mV
Accuracy (@25°C/77°F)	±5 mV
Calibration	manual, with CAL trimmer
Dosing Relay	maximum 2A (fuse protected), 250 Vac, 30 VDC
Dosing Selection	reducing or oxidizing, selectable on the back panel contact open=reductant dosage=relay ON if measure > setpoint contact closed=oxidant dosage=relay ON if measure < setpoint
Setpoint	adjustable, from 0 to 1000 mV
Overtime	adjustable, from 5 to approximately 30 minutes
Input Impedance	10 <sup>12</sup> Ohm
Power Supply	BL982411-0: 12 VDC adapter (included); BL982411-1: 115/230 VAC; 50/60Hz
Dimensions	83 x 53 x 99 mm (3.3 x 2.1 x 3.9")
Weight	BL982411-0: 200 g (7.1 oz.); BL982411-1: 300 g (10.6 oz.)
Ordering Information	<b>BL982411-0</b> (12 VDC) and <b>BL982411-1</b> (115/230 VAC) are supplied with mounting brackets, transparent cover and instruction manual.
Recommended Probe	<b>HI2001</b> PVDF body ORPelectrode with 1/2" NPT thread, BNC connector and 3 m (9.8') cable for continuous flow-thru monitoring (not included).



BL932700

## ORP Mini Controller

with 4-20 mA Recorder Output

- Large Clear LCD
- Fire Retardant Casing
- BNC Connection
- Splash-Resistant Cover

The BL932700 is a compact, ORP process controller designed for applications where space or cost is important. The device may be used with any ORP electrode with a standard BNC connector. Users may choose from automatic or manual dosing modes allowing for easy maintenance and troubleshooting.

### Adjustable Dosing Relay

The BL932700 features a dosing relay which may be configured to dose above or below a user programmable mV setpoint.

### Selectable Overdose Protection

The mini controller may be programmed to deactivate a valve, pump, or connected device if its activation continues over a selected time; adjustable from 5 to 30 minutes.

### Relay Control Override

With the flick of a switch the mini controller's relay can be disabled (OFF), placed in control (AUTO), or be activated for manual operation (ON) which is useful for priming a dosing pump.

### Analog Output Communication

The BL932700 features a 4 - 20 mA analog output for connection to a data logger, chart recorder, or other device.

### External Disabling Feature

A normally open contact may connect to a level controller or flow monitor. This safety feature may be used to prevent continuous dosing in the event of specific or undesired system conditions.

### Matching Pin Connection

A built-in matching pin helps protect the sensor from ground loop effects that may lead to erratic readings or system damage.

Specifications	BL932700
Range	±1000 mV
Resolution	1 mV
Accuracy (@25°C/77°F)	±5 mV
Calibration	manual, with CAL trimmer
Dosing Relay	maximum 2A (fuse protected), 250 Vac, 30 VDC
Dosing Selection	reducing or oxidizing, selectable on the back panel contact open= reductant dosage=relay ON if measure > setpoint contact closed= oxidant dosage=relay ON if measure < setpoint
Setpoint	adjustable from -1000 to 1000 mV
Overtime	adjustable, from 5 to approximately 30 minutes
Recorder Output	4 to 20 mA, accuracy ±0.20 mA, 500 Ω maximum load
Input Impedance	10 <sup>12</sup> Ohm
Power Supply	BL932700-0: 12 VDC adapter (included); BL932700-1: 115/230 VAC; 50/60Hz
Dimensions	83 x 53 x 99 mm (3.3 x 2.1 x 3.9")
Weight	BL932700-0: 200 g (7.1 oz.) BL932700-1: 300 g (10.6 oz.)
Ordering Information	<b>BL932700-0</b> (12 VDC) and <b>BL932700-1</b> (115/230 VAC) are supplied with mounting brackets, transparent cover and instruction manual.
Recommended Probe	<b>HI2001</b> PVDF body ORPelectrode with 1/2" NPT thread, BNC connector and 3 m (9.8') cable for continuous flow-thru monitoring (not included).

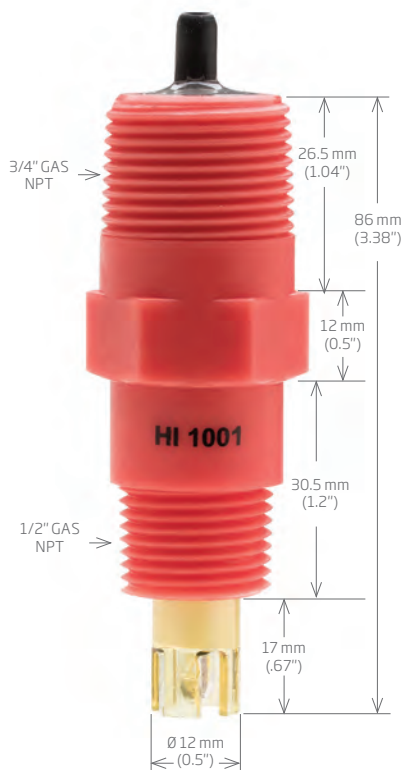

HI1001 • HI2001

## pH Electrode and ORP Electrode with Pt sensor for Continuous Flow-thru Monitoring

*Specifically Built for Industrial Applications*

The HI1001 (pH) and HI2001 (ORP) are flow-thru monitoring electrodes with BNC connection and 3 m cable that have been specifically built for industrial applications. These durable electrodes have a PVDF body with a protective PEI sleeve around the glass bulb for resistance against mechanical stress. This sensor provides a rapid response and high accuracy measurements for industrial applications.

### Spherical Glass Tip

The spherical shaped tip design allows for a wide area of contact with the sample. This permits a faster electrode response with a higher degree of stability.

### PVDF Body

Resistant to most chemicals and solvents, the PVDF body has high abrasion resistance, mechanical strength, and resistance to ultraviolet and nuclear radiation. PVDF is also resistant to fungal growth.

### PTFE Junction

This type of junction is often used on electrodes with polymer electrolytes. Porous polytetrafluoroethylene (PTFE) is a hydrophobic material that is available with different porosities that helps to minimize clogging. Because of its chemical advantages, PTFE is widely used in industrial applications.

### Double Junction Reference

The double junction design presents a silver-free electrolyte solution interacting with the sample, making the electrode less susceptible to

clogging and guaranteeing a fast response and stable reading. This design allows measurement in applications where silver ions in the sample are undesirable or silver precipitates on the junction are likely to form.

### BNC Connector

HI1001 and HI2001 use a BNC connector. This type of connector is universal in that it can be used on any pH meter that has the female BNC probe input.

### External Thread

The top 1/2" NPT thread of the HI1001 and HI2001 allows for in-line installation while the bottom 3/4" thread (cable side) allows for submersion mounting.

Specifications	HI1001	HI2001
Measurement	pH	ORP
Junction	double, PTFE	double, PTFE
Electrolyte	polymer	polymer
Temperature	-5 to 80°C (23 to 176°F) - HT	-5 to 80°C (23 to 176°F)
Max Pressure	6 bar (87 psi)	6 bar (87 psi)
Connector	BNC	BNC
Cable	3 m	3 m
Ordering Information	<b>HI1001</b> with 3 m (9.84') of cable attached	<b>HI2001</b> with 3 m (9.84') of cable attached
Recommended Controllers	BL981411, BL931700	BL982411, BL932700





BL983313 • BL983320 • BL983322

## EC Mini Controllers

Measuring in  $\mu\text{S}/\text{cm}$

- Models available with 4-20 mA galvanic isolated output with external dosing disable contact
- Large Clear LCD
- Fire Retardant Casing
- Splash-Resistant Cover

These compact, panel mounted, process controllers are for measuring electrolytic conductivity (EC) of a process stream. Users may choose from automatic or manual dosing modes. When in automatic mode the dry contact relay is activated when a reading is above the set point.

HI983313's relay can be used to activate a dosing pump or a solenoid that controls a valve. HI983313 is ideal for source water or rinse water applications.

BL983320's relay can be used to activate a solenoid that switches from one DI (deionized) tank to another or to open a valve that will allow lower EC water to flow into a tank being monitored in order to lower its EC. The BL983320 can also be used to monitor the quality of water produced from ion exchange, reverse osmosis (RO) or distillation.

BL983322's relay can be used to activate a solenoid that switches from one DI (deionized) tank to another or to open a valve that will allow lower EC water to flow into a tank being monitored in order to lower its EC. The BL983322 can also be used to monitor the quality of water from DI tanks or from a distillation apparatus.

Specifications	BL983313	BL983320	BL983322
Range	0 to 1999 $\mu\text{S}/\text{cm}$	0.0 to 199.9 $\mu\text{S}/\text{cm}$	0.00 to 19.99 $\mu\text{S}/\text{cm}$
Resolution	1 $\mu\text{S}/\text{cm}$	0.1 $\mu\text{S}/\text{cm}$	0.01 $\mu\text{S}/\text{cm}$
Accuracy	$\pm 2\%$ f.s. at 25 °C (77 °F)		
Temperature Compensation	automatic from 5 to 50 °C (41 to 122 °F) with $\beta = 2\%/^{\circ}\text{C}$		
Calibration	manual, with calibration trimmer		
Output	galvanic isolated 4-20 mA output; accuracy $\pm 0.2$ mA; 500 $\Omega$ maximum load (BL9833XX-2 only)		
Dosing	adjustable setpoint	covers measure range	
	relay	relay closes when reading > setpoint	
	dosing contact	maximum 2A (internal fuse protection), 250 VAC or 30 VDC	
	overtime	Dosing relay is disabled if setpoint is not reached within the set time interval. Timer adjustable between approx. 5 to 30 minutes, or disabled by jumper.	
	external disable input	Normally Open: enable / Closed: disable dosing (BL9833XX-2 only)	
Power Supply	models "-0": 12 VDC adapter (included) models "-1": 115/230 VAC; 50/60Hz models "-2": 115/230 VAC, 4-20 mA Output input: 10 VA for 115/230 VAC, 50/60 Hz models; 3 W for 12 VDC models; fuse protected; installation category II.		
Dimensions	83 x 53 x 99 mm (3.3 x 2.1 x 3.9")		
Weight	12 VDC models, 200 g (7.1 oz); 115/230 VAC models 300 g (10.6 oz)		
Ordering Information	<b>BL983313-0</b> (12 VDC), <b>BL983313-1</b> (115/230 VAC), <b>BL983313-2</b> (115/230 VAC, 4-20 mA Output), <b>BL983320-0</b> (12 VDC), <b>BL983320-1</b> (115/230 VAC), <b>BL983320-2</b> (115/230 VAC, 4-20 mA Output) <b>BL983322-0</b> (12 VDC) and <b>BL983322-1</b> (115/230 VAC) and <b>BL983322-2</b> (115/230 VAC, 4-20 mA Output) are supplied with mounting brackets, transparent cover and quick reference guide with instrument quality certificate.		
Recommended Probe	<b>HI7634-00</b> EC/TDS probe with internal temperature sensor and 2 m (6.6') cable (not included). <b>HI7634-00/4</b> EC/TDS probe with internal temperature sensor and 4 m (13.1') cable (not included). <b>HI7634-00/5</b> EC/TDS probe with internal temperature sensor and 5 m (16.4') cable (not included).		

### Adjustable Dry Contact Dosing Relay

These mini controllers feature a dosing relay that is activated when the reading is above a user programmable set point.

### Programmable Overdose Protection

For enhanced safety the mini controller can be programmed to deactivate the dosing relay if the set point is not reached within a specified time interval. The overdosing timer is programmable from 5 to 30 minutes or disabled.

### Relay Control Override

With the flick of a switch the mini controller's relay can be disabled (Off), placed in control (Auto), or be activated for manual operation (On) which is useful for priming a dosing pump.

### Multicolor LED Indicator

Multicolor LED indicator allows an operator to quickly check the status of the controller. Green = Meter in measurement mode and reading is below the set point. Orange/Yellow = Reading is above the set point and the relay is activated. Blinking Red = Indicates an alarm condition such as when the maximum dosing time has been exceeded.

### Fuse Protected Dosing Contacts

The relay dosing contact is rated for up to a 2A load and is fuse protected.

### Labeled Termination Connections

Quick-connect terminal blocks are clearly labeled for easy connection to power, conductivity probe and relay that can be used to operate a dosing pump, valve, audible alarm, or light.

BL983317 • BL983327

## EC Mini Controllers

Measuring in mS/cm

- Models available with 4-20 mA galvanic isolated output with external dosing disable contact
- Large Clear LCD
- Fire Retardant Casing
- Splash-Resistant Cover

The BL983317 and BL983327 are compact, panel mounted, process controllers for measuring conductivity of a process stream. The device features a large LCD with protective cover. Users may choose from automatic or manual dosing modes.

BL983317: When in automatic mode, the dry contact relay is activated when a reading is below the set point. The relay can be used to activate a dosing pump to add chemical until the desired set point is reached. Chemicals that can be dosed include nutrient solutions.

BL983327: When in automatic mode, the dry contact relay is activated when a reading is above the set point. The relay can be used to activate a solenoid valve to open and drain a tank (i.e. boiler bleed and feed) or add freshwater until the desired set point is reached.

### Adjustable Dry Contact Dosing Relay

The BL983317 features a dosing relay that is activated when the reading is below a user programmable set point.

The BL983327 features a dosing relay that is activated when the reading is above a user programmable set point.

### Programmable Overdose Protection

For enhanced safety the mini controller can be programmed to deactivate the dosing relay if the set point is not reached within a specified time interval. The overdosing timer is programmable from 5 to 30 minutes or disabled.

### Relay Control Override

With the flick of a switch the mini controller's relay can be disabled (Off), placed in control (Auto), or be activated for manual operation (On) which is useful for priming a dosing pump.

### Multicolor LED Indicator

Multicolor LED indicator allows an operator to quickly check the status of the controller. Green = Meter in measurement mode and reading is above (BL983317) or below (BL983327) the set point. Orange/Yellow = Reading is below (BL983317) or above (BL983327) the set point and the relay is active. Blinking Red = Indicates an alarm condition such as when the maximum dosing time has been exceeded.

### Fuse Protected Dosing Contacts

The relay dosing contact is rated for up to a 2A load and is fuse protected.

### Labeled Termination Connections

Quick-connect terminal blocks are clearly labeled for easy connection to power, conductivity probe and relay that can be used to operate a dosing pump, valve, audible alarm, or light.



Specifications	BL983317	BL983327	
Range	0.00 to 10.00 mS/cm		
Resolution	0.01 mS/cm		
Accuracy	±2% f.s. at 25 °C (77 °F)		
Temperature Compensation	automatic, from 5 to 50°C (41 to 122°F) with $\beta=2\%/^{\circ}\text{C}$		
Calibration	manual, with calibration trimmer		
Output	galvanic isolated 4-20 mA output; accuracy ±0.2 mA; 500 Ω maximum load (BL9833XX-2 only)		
Dosing	adjustable setpoint	adjustable setpoint: covers measure range	
	relay	relay closes when reading < setpoint	relay closes when reading > setpoint
	dosing contact	maximum 2A (internal fuse protection), 250 VAC or 30 VDC	
	overtime	dosing relay is disabled if setpoint is not reached within the set time interval. Timer adjustable between approx. 5 to 30 minutes, or disabled by jumper.	
	external disable input	Normally Open: enable / Closed: disable dosing (BL9833XX-2 only)	
Power Supply	models "-0": 12 VDC adapter (included) models "-1": 115/230 VAC, 50/60Hz models "-2": 115/230 VAC, 4-20 mA Output  input: 10 VA for 115/230 VAC, 50/60 Hz models; 3 W for 12 VDC models; fuse protected; installation category II.		
Dimensions	83 x 53 x 99 mm (3.3 x 2.1 x 3.9")		
Weight	12 VDC models, 200 g (7.1 oz); 115/230 VAC models 300 g (10.6 oz)		
Ordering Information	<b>BL983317-0</b> (12 VDC), <b>BL983317-1</b> (115/230 VAC), <b>BL983317-2</b> (115/230 VAC, 4-20 mA Output), <b>BL983327-0</b> (12 VDC), <b>BL983327-1</b> (115/230 VAC), <b>BL983327-2</b> (115/230 VAC, 4-20 mA Output) are supplied with mounting brackets, transparent cover and quick reference guide with instrument quality certificate.		
Recommended Probe	<b>HI7632-00</b> EC/TDS probe with internal temperature sensor and 2 m (6.6') cable (not included). <b>HI7632-00/6</b> EC/TDS probe with internal temperature sensor and 6 m (19.7') cable (not included).		

See EC/TDS probes and cable lengths on page 15.90; EC solutions begin on page 5.36; see rear connections on page 15.93



BL983315 • BL983319  
BL983321 • BL983329

## TDS Mini Controllers

- Models available with 4-20 mA galvanic isolated output with external dosing disable contact
- Large Clear LCD
- Fire Retardant Casing
- Splash-Resistant Cover

These compact, panel mounted, process controllers are for measuring total dissolved solids (TDS) of a process stream. The controllers feature a large LCD with protective cover. Users may choose from automatic or manual dosing modes.

BL983315: When in automatic mode, the dry contact relay is activated when a reading is above the set point. The relay can be used to supply power to a dosing pump or a solenoid connected to a valve. The BL983315 can also be used to monitor the quality of water produced from ion exchange, reverse osmosis (RO) or distillation.

BL983315 uses a 0.5 conversion factor in which  $1.0 \mu\text{S}/\text{cm} = 0.5 \text{ ppm}$ .

BL983319: When in automatic mode, the dry contact relay is activated when a reading is below the set point. The relay can be used to supply power to a dosing pump to add fertilizer to a nutrient solution in order to maintain an ideal concentration.

BL983319 uses a 0.65 conversion factor in which  $100 \mu\text{S}/\text{cm} = 65 \text{ ppm}$ .

BL983321: When in automatic mode, the dry contact relay is activated when a reading is above the set point. The relay can be used to activate a solenoid that switches from one DI (deionized) tank to another or to open a valve that will allow lower TDS water to flow into a tank being monitored in order to lower its TDS. The BL983321 can also be used to monitor the quality of water produced from ion exchange, reverse osmosis (RO) or distillation.

BL983321 uses a 0.5 conversion factor in which  $1.00 \mu\text{S}/\text{cm} = 0.50 \text{ ppm}$ .

BL983329: When in automatic mode, The dry contact relay is activated when a reading is above the set point. The relay can be used to supply power to a dosing pump or a solenoid connected to a valve.

BL983329 uses a 0.5 conversion factor in which  $100 \mu\text{S}/\text{cm} = 50 \text{ ppm}$ .

Specifications	BL983315	BL983319	BL983321	BL983329
Range	0.0 to 199.9 mg/L (ppm)	0 to 1999 mg/L (ppm)	0.00 to 19.99 mg/L (ppm)	0 to 999 mg/L (ppm)
Resolution	0.1 mg/L (ppm)	1 mg/L (ppm)	0.01 mg/L (ppm)	1 mg/L (ppm)
Accuracy	$\pm 2\%$ f.s. at 25 °C (77 °F)			
TDS Factor	0.5	0.65	0.5	0.5
Temperature Compensation	automatic from 5 to 50°C (41 to 122°F) with $\beta = 2\%/^{\circ}\text{C}$			
Calibration	manual, with calibration trimmer			
Output	galvanic isolated 4-20 mA output; accuracy $\pm 0.2 \text{ mA}$ ; 500 $\Omega$ maximum load (BL9833XX-2 only)			
Dosing	adjustable setpoint	adjustable setpoint: covers measure range		
	relay	relay closes when reading > setpoint	relay closes when reading < setpoint	relay closes when reading > setpoint
	dosing contact	maximum 2A (internal fuse protection), 250 VAC or 30 VDC		
	overtime	dosing relay is disabled if setpoint is not reached within the set time interval. Timer adjustable between approx. 5 to 30 minutes, or disabled by jumper.		
	external disable input	Normally Open: enable / Closed: disable dosing (BL9833XX-2 only)		
Power Supply	models "-0": 12 VDC adapter (included) models "-1": 115/230 VAC; 50/60Hz models "-2": 115/230 VAC, 4-20 mA Output input: 10 VA for 115/230 VAC, 50/60 Hz models; 3 W for 12 VDC models; fuse protected; installation category II.			
Dimensions	83 x 53 x 99 mm (3.3 x 2.1 x 3.9")			
Weight	12 VDC models, 200 g (7.1 oz); 115/230 VAC models 300 g (10.6 oz)			
Ordering Information	BL983315-0 (12 VDC), BL983315-1 (115/230 VAC), BL983315-2 (115/230 VAC, 4-20 mA Output), BL983319-0 (12 VDC), BL983319-1 (115/230 VAC), BL983319-2 (115/230 VAC, 4-20 mA Output), BL983321-0 (12 VDC), BL983321-1 (115/230 VAC), BL983329-0 (12 VDC), BL983329-1 (115/230 VAC), and BL983329-2 (115/230 VAC, 4-20 mA Output), are supplied with mounting brackets, transparent cover and quick reference guide with instrument quality certificate.			
Recommended Probe	HI7634-00 EC/TDS probe with internal temperature sensor and 2 m (6.6') cable (not incl). HI7634-00/4 EC/TDS probe with internal temperature sensor and 4 m (13.1') cable (not incl). HI7634-00/5 EC/TDS probe with internal temperature sensor and 5 m (16.4') cable (not incl).			

BL983318

## TDS Mini Controllers

0 to 10,000 ppm

- Large Clear LCD
- Fire Retardant Casing
- Splash-Resistant Cover

The BL983318 is a compact, panel mounted, process controller for measuring total dissolved solids (TDS) of a process stream. The device features a large LCD with protective cover. Users may choose from automatic or manual dosing modes. When in automatic mode the dry contact relay is activated when a reading is above the set point. The relay can be used to activate a solenoid valve to open and drain a tank (i.e. boiler bleed and feed) or add freshwater until the desired set point is reached. The BL983318 uses a 0.5 conversion factor in which 1.00 mS/cm = 0.50 ppt. The BL983318 can measure TDS from 0.00 to 10.00 ppt (g/L).

### Adjustable Dry Contact Dosing Relay

The BL983318 features a dosing relay that is activated when the reading is above a user programmable set point.

### Programmable Overdose Protection

For enhanced safety the mini controller can be programmed to deactivate the dosing relay if the set point is not reached within a specified time interval. The overdosing timer is programmable from 5 to 30 minutes or disabled.

### Relay Control Override

With the flick of a switch the mini controller's relay can be disabled (Off), placed in control (Auto), or be activated for manual operation (On) which is useful for priming a dosing pump.

### Multicolor LED Indicator

Multicolor LED indicator allows an operator to quickly check the status of the controller. Green = Meter in measurement mode and reading is below the set point. Orange/Yellow = Reading is above the set point and the relay is active. Blinking Red = Indicates an alarm condition such as when the maximum dosing time has been exceeded.

### Fuse Protected Dosing Contacts

The relay dosing contact is rated for up to a 2A load and is fuse protected.

### Labeled Termination Connections

Quick-connect terminal blocks are clearly labeled for easy connection to power, conductivity probe and relay that can be used to operate a dosing pump, valve, audible alarm, or light.



Specifications		BL983318
Range		0.00 to 10.00 g/L (ppt)
Resolution		0.01 g/L (ppt)
Accuracy		±2% f.s. at 25 °C (77 °F)
TDS Factor		0.5
Temperature Compensation		automatic from 5 to 50°C (41 to 122°F) with $\beta = 2\%/^{\circ}\text{C}$
Calibration		manual, with calibration trimmer
Dosing	adjustable setpoint	covers measure range
	relay	relay closes when reading > setpoint
	dosing contact	maximum 2A (internal fuse protection), 250 VAC or 30 VDC
	overtime	dosing relay is disabled if setpoint is not reached within the set time interval. Timer adjustable between approx. 5 to 30 minutes, or disabled by jumper.
Power Supply		models "-0": 12 VDC adapter (included) models "-1": 115/230 VAC; 50/60Hz input: 10 VA for 115/230 VAC, 50/60 Hz models; 3 W for 12 VDC models; fuse protected; installation category II.
Dimensions		83 x 53 x 99 mm (3.3 x 2.1 x 3.9")
Weight		12 VDC models, 200 g (7.1 oz); 115/230 VAC models 300 g (10.6 oz)
Ordering Information		<b>BL983318-0</b> (12 VDC) and <b>BL983318-1</b> (115/230 VAC) are supplied with mounting brackets, transparent cover and quick reference guide with instrument quality certificate.
Recommended Probe		<b>HI7632-00</b> EC/TDS probe with internal temperature sensor and 2 m (6.6') cable (not included). <b>HI7632-00/6</b> EC/TDS probe with internal temperature sensor and 6 m (19.7') cable (not included).



BL983324

## TDS Mini Controllers

- Large Clear LCD
- Fire Retardant Casing
- Splash-Resistant Cover

The BL983324 is a compact, panel mounted, process controller for measuring total dissolved solids (TDS) of a process stream that is within the 0.0 to 49.9 ppm (mg/L) range. The device features a large LCD with protective cover. Users may choose from automatic or manual dosing modes. When in automatic mode the dry contact relay is activated when a reading is above the set point. The relay can be used to supply power to a dosing pump or a solenoid connected to a valve. The BL983324 can also be used to monitor the quality of water produced from ion exchange, reverse osmosis (RO) or distillation.

The BL983324 uses a 0.5 conversion factor in which  $1.0 \mu\text{S}/\text{cm} = 0.5 \text{ ppm}$ .

### Adjustable Dry Contact Dosing Relay

The BL983324 features a dosing relay that is activated when the reading is above a user programmable set point.

### Programmable Overdose Protection

For enhanced safety the mini controller can be programmed to deactivate the dosing relay if the set point is not reached within a specified time interval. The overdosing timer is programmable from 5 to 30 minutes or disabled.

### Relay Control Override

With the flick of a switch the mini controller's relay can be disabled (Off), placed in control (Auto), or be activated for manual operation (On) which is useful for priming a dosing pump.

### Multicolor LED Indicator

Multicolor LED indicator allows an operator to quickly check the status of the controller. Green = Meter in measurement mode and reading is below the set point. Orange/Yellow = Reading is above the set point and the relay is activated. Blinking Red = Indicates an alarm condition such as when the maximum dosing time has been exceeded.

### Fuse Protected Dosing Contacts

The relay dosing contact is rated for up to a 2A load and is fuse protected.

### Labeled Termination Connections

Quick-connect terminal blocks are clearly labeled for easy connection to power, conductivity probe and relay that can be used to operate a dosing pump, valve, audible alarm, or light.

Specifications	BL983324	
Range	0.0 to 49.9 mg/L (ppm)	
Resolution	0.1 mg/L (ppm)	
Accuracy	$\pm 2\%$ f.s. at 25 °C (77 °F)	
TDS Factor	0.5	
Temperature Compensation	automatic, from 5 to 50°C (41 to 122°F) with $\beta=2\%/^{\circ}\text{C}$	
Calibration	manual, with calibration trimmer	
Dosing	adjustable setpoint	covers measure range
	relay	relay closes when reading > setpoint
	dosing contact	maximum 2A (internal fuse protection), 250 VAC or 30 VDC
	overtime	dosing relay is disabled if setpoint is not reached within the set time interval. Timer adjustable between approx. 5 to 30 minutes, or disabled by jumper.
Power Supply	models "-0": 12 VDC adapter (included) models "-1": 115/230 VAC, 50/60Hz input: 10 VA for 115/230 VAC, 50/60 Hz models; 3 W for 12 VDC models; fuse protected; installation category II.	
Dimensions	83 x 53 x 99 mm (3.3 x 2.1 x 3.9")	
Weight	12 VDC models, 200 g (7.1 oz); 115/230 VAC models 300 g (10.6 oz)	
Ordering Information	<b>BL983324-0</b> (12 VDC) and <b>BL983324-1</b> (115/230V) are supplied with mounting brackets, transparent cover and quick reference guide with instrument quality certificate.	
Recommended Probe	<b>HI7634-00</b> EC/TDS probe with internal temperature sensor and 2 m (6.6') cable (not included). <b>HI7634-00/4</b> EC/TDS probe with internal temperature sensor and 4 m (13.1') cable (not included). <b>HI7634-00/5</b> EC/TDS probe with internal temperature sensor and 5 m (16.4') cable (not included).	

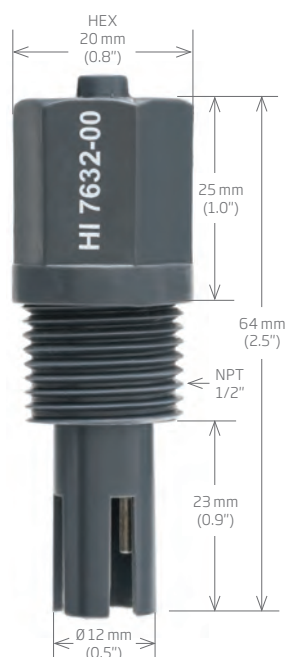

## High Range Probe for EC/TDS Mini Controllers (mS/cm and ppt)

- Two-pole amperometric probe
- Internal temperature sensor
- High range measurement (mS/cm and ppt)

The HI7632-00 is a two-pole amperometric EC/TDS probe for panel mounted mini controllers that measure in the **high range (mS/cm and ppt)**. This probe has a built-in temperature sensor for Automatic Temperature Compensation and a ½" male NPT threaded connection for insertion mounting. The HI7632-00 probe provides a rapid response and high accuracy EC or TDS measurement.

Specifications	HI7632-00
Type	Two-pole Amperometric
NTC Sensor	4.7 KΩ
Cell Constant	1 cm <sup>-1</sup>
Materials	PVC body; AISI 316 electrodes
Temperature	5 to 50 °C (41 to 122 °F)
Maximum Pressure	3 bar
Probe Length	64 mm (2.5")
Connection	½" NPT thread
Cable Length	2 m (6.6') and 6 m (19.7') available
<b>Ordering Information</b>	<b>HI7632-00</b> with 2 m (6.6') of cable attached <b>HI7632-00/6</b> with 6 m (19.7') of cable attached
<b>Recommended Controllers</b>	BL983317, BL983318, BL983327

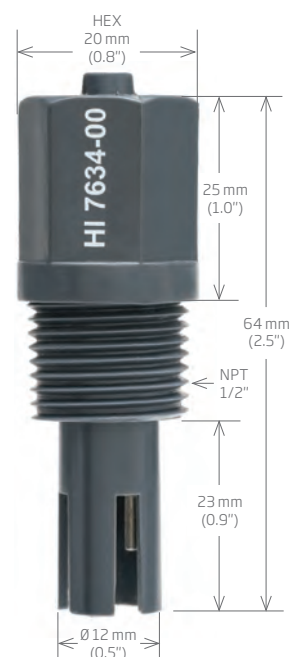

## Low Range Probe for EC/TDS Mini Controllers (µS/cm and ppm)

- Two-pole amperometric probe
- Internal temperature sensor
- Low range measurement (µS/cm and ppm)

The HI7634-00 is a two-pole amperometric EC/TDS probe for panel mounted mini controllers that measure in the **low range (µS/cm and ppm)**. This probe has a built-in temperature sensor for Automatic Temperature Compensation and a ½" male NPT threaded connection for insertion mounting. The HI7634-00 probe provides a rapid response and high accuracy EC or TDS measurement.

Specifications	HI7634-00
Type	Two-pole Amperometric
NTC Sensor	9.4 KΩ
Cell Constant	1 cm <sup>-1</sup>
Materials	PVC body; AISI 316 electrodes
Temperature	5 to 50 °C (41 to 122 °F)
Maximum Pressure	3 bar
Probe Length	64 mm (2.5")
Connection	½" NPT thread
Cable Length	2 m (6.6'), 4 m (13.1'), and 5 m (16.4') available
<b>Ordering Information</b>	<b>HI7634-00</b> with 2 m (6.6') of cable attached <b>HI7634-00/4</b> with 4 m (13.1') of cable attached <b>HI7634-00/5</b> with 5 m (16.4') of cable attached
<b>Recommended Controllers</b>	BL983313, BL983315, BL983319, BL983320, BL983321, BL983322, BL983324, BL983329

BL983314

## Resistivity Mini Controllers

- Large Clear LCD
- Fire Retardant Casing
- Splash-Resistant Cover



The BL983314 is a simple to operate resistivity controller designed for ultra pure water, reverse osmosis, and water conditioning applications. The BL983314 resistivity controller is also ideal for continuous monitoring of process solutions. Setpoint and calibration are manually adjusted with a trimmer and the alarm relay allows for simple control.

### Adjustable Dry Contact Dosing Relay

The BL983314 features a dosing relay that is activated when the reading is below a user programmable set point.

### Programmable Overdose Protection

For enhanced safety the mini controller can be programmed to deactivate the dosing relay if the set point is not reached within a specified time interval. The overdosing timer is programmable from 5 to 30 minutes or disabled.

### Relay Control Override

With the flick of a switch the mini controller's relay can be disabled (Off), placed in control (Auto), or be activated for manual operation (On) which is useful for priming a dosing pump.

### Multicolor LED Indicator

Multicolor LED indicator allows an operator to quickly check the status of the controller. Green = Meter in measurement mode and reading is above the set point. Orange/Yellow = Reading is below the set point and the relay is activated. Blinking Red = Indicates an alarm condition such as when the maximum dosing time has been exceeded.

### Fuse Protected Dosing Contacts

The relay dosing contact is rated for up to a 2A load and is fuse protected.

### Labeled Termination Connections

Quick-connect terminal blocks are clearly labeled for easy connection to power, conductivity probe and relay that can be used to operate a dosing pump, valve, audible alarm, or light.

Specifications	BL983314
Range	0.00 to 19.90 MΩ•cm
Resolution	0.10 MΩ•cm
Accuracy (@25°C/ 77°F)	±2% F.S.
Temperature Compensation	automatic and linear from 5 to 50°C (41 to 122°F)
Temperature Coefficient	β=2.4 ; 3.5 ; 4.5 %/°C selectable through jumper on the rear panel
Calibration	factory calibrated
Dosing Relay	maximum 2A (fuse protected), 250 Vac, 30 VDC contact closed when measure < setpoint
Setpoint	adjustable from 0 to 19.90 MΩ•cm
Overtime	adjustable, typically from 5 to approximately 30 minutes
Power Supply	BL983314-0: 12 VDC adapter (included) BL983314-1: 115/230 VAC; 50/60Hz
Dimensions	83 x 53 x 99 mm (3.3 x 2.1 x 3.9")
Weight	BL983314-0: 200 g (7.1 oz.) BL983314-1: 300 g (10.6 oz.)
Ordering Information	<b>BL983314-0</b> (12 VDC) and <b>BL983314-1</b> (115/230V) are supplied with mounting brackets, transparent cover and instruction manual.
Recommended Probe	<b>HI3314</b> resistivity probe with 2 m (6.6') cable (included)

# Rear Connections



HI981411-1 rear connections example shown

## BL981411

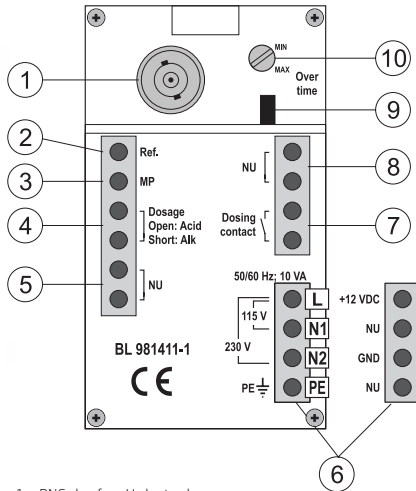

1. BNC plug for pH electrode
2. Connection for electrode reference
3. Connection for potential Matching Pin
4. Acid/Alkaline dosage selection terminal:
  - contact open = acid selection
  - contact closed = alkaline selection
5. Not Used contact
6. Power supply terminal:
  - for BL981411-0 model: 12 Vdc adapter
  - for BL981411-1 model: 115 Vac or 230 Vac option
7. This contact acts as a switch for driving the dosing system (e.g. dosing pump)
8. Not Used contact
9. Jumper for enabling (jumper in) or disabling (jumper removed) the overtime control
10. Trimmer for overtime setting (typically from 5 to 30 minutes)

## BL931700

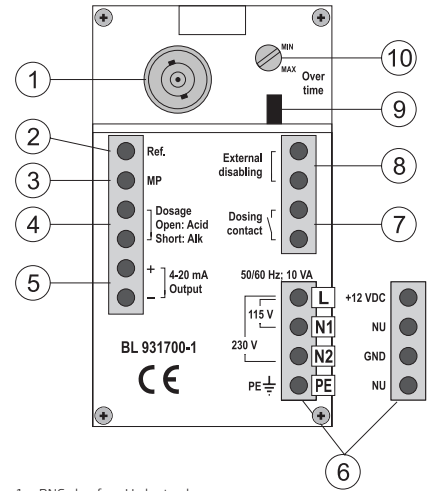

1. BNC plug for pH electrode
2. Connection for electrode reference
3. Connection for potential Matching Pin
4. Acid/Alkaline dosage selection terminal:
  - contact open = acid selection
  - contact closed = alkaline selection
5. 4-20 mA output terminal for recorder connection
6. Power supply terminal:
  - for BL931700-0 model: 12 Vdc adapter
  - for BL931700-1 model: 115 Vac or 230 Vac option
7. This contact acts as a switch for driving the dosing system (e.g. dosing pump)
8. External control and disabling of dosing system
9. Jumper for enabling (jumper in) or disabling (jumper removed) the overtime control
10. Trimmer for overtime setting (typically from 5 to 30 minutes)

## BL982411

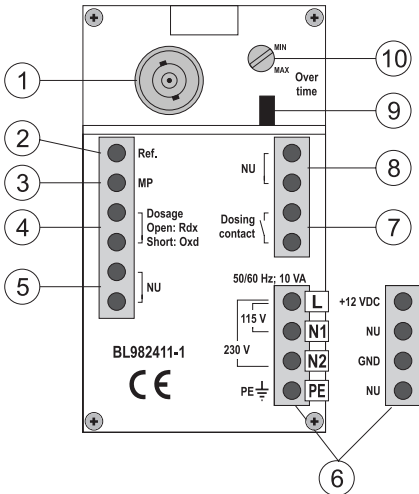

1. BNC plug for ORP electrode
2. Connection for electrode reference
3. Connection for potential Matching Pin
4. Rdx/Oxd dosage selection terminal:
  - contact open = reductant selection
  - contact closed = oxidant selection
5. Not Used contact
6. Power supply terminal:
  - for BL982411-0 model: 12 Vdc adapter
  - for BL982411-1 model: 115 Vac or 230 Vac option
7. This contact acts as a switch for driving the dosing system (e.g. dosing pump)
8. Not Used contact
9. Jumper for enabling (jumper in) or disabling (jumper removed) the overtime control
10. Trimmer for overtime setting (typically from 5 to 30 minutes)

## BL932700

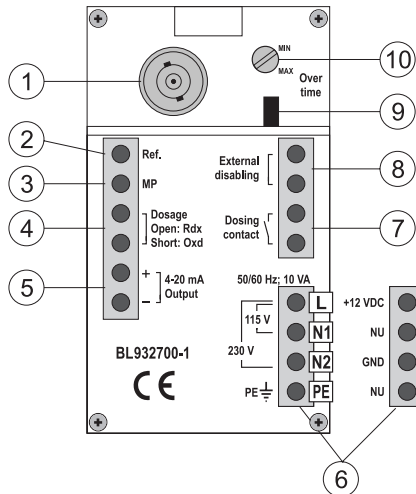

1. BNC plug for ORP electrode
2. Connection for electrode reference
3. Connection for potential Matching Pin
4. Rdx/Oxd dosage selection terminal:
  - contact open = reductant selection
  - contact closed = oxidant selection
5. 4-20 mA output terminal for recorder connection
6. Power supply terminal:
  - for BL932700-0 model: 12 Vdc adapter
  - for BL932700-1 model: 115 Vac or 230 Vac option
7. This contact acts as a switch for driving the dosing system (e.g. dosing pump)
8. External control and disabling of dosing system
9. Jumper for enabling (jumper in) or disabling (jumper removed) the overtime control
10. Trimmer for overtime setting (typically from 5 to 30 minutes)



HI983320-1 rear connections example shown



BL983313, BL983315, BL983317, BL983318, BL983319, BL983320,  
BL983321, BL983322, , BL983324, BL983327, BL983329

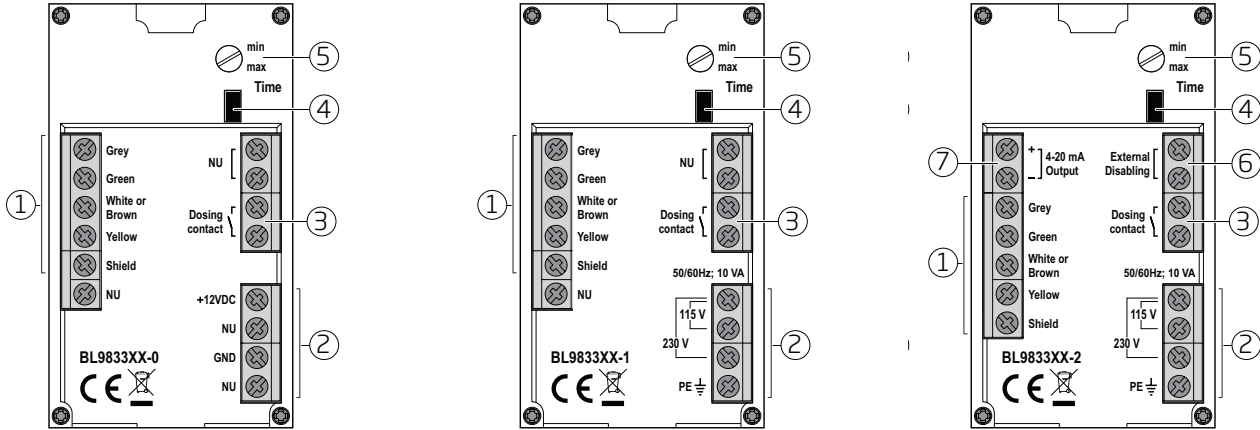

1. Probe connection terminal, low voltage connections
2. Power supply terminal
  - BL9833XX-1 & BL9833XX-2 series, high voltage connections, 115/220 VAC
  - BL9833XX-0 series, low voltage connections, 12 VDC
3. Contact acts as a switch for driving the dosing system
4. External disabling contacts
5. Jumper for enabling (jumper in) or disabling (jumper removed) the overtime control
6. Trimmer for overtime setting (between 5 and 30 minutes)
7. 4-20 mA output contacts
  - BL9833XX-2 series only
  - Follow lead markings +positive / -negative to ensure output leads are correctly wired

BL983314

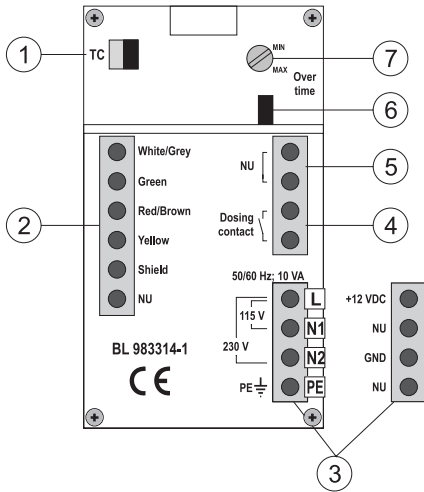

1. TC jumper for selection of temperature coefficient ( $\beta$ )
2. Connections for HI 3314 resistivity probe
3. Power supply terminal:
  - for BL983314-0 model: 12 Vdc adapter
  - for BL983314-1 model: 115 Vac or 230 Vac option
4. This contact acts as a switch for driving the dosing system (e.g. dosing pump)
5. Not used contact
6. Jumper for enabling (jumper in) or disabling (jumper removed) the overtime control
7. Trimmer for overtime setting (typically from 5 to 30 minutes)

## Mini Level Controllers

The HI7871 and HI7873 mini level controllers are ideal for liquid level control over distances of up to 100 m (330'). These instruments are highly compact and will fit in tight spaces.

These easy-to-use controllers are suited for nearly any liquid level application, such as industrial and municipal water treatment, nutrient tank control in farming, hydroponics, aquaculture and plating rinse baths.

The HI7871 features high and low level control, while the HI7873 includes an overflow alarm. Both instruments are connected to a two-wire transmitter (HI7874), which is ideal for level monitoring in remote applications.

### A complete liquid level measuring system requires:

- 1) A controller (HI7871 or HI7873)
- 2) A bar holder with amplifier circuitry (HI7874)
- 3) A package of measuring bars (HI731324)
- 4) An undecal connector (HI7164)



HI7164  
Undecal Connector



HI7874  
Level Transmitter with  
HI731324 Stainless Steel  
Measuring Bars



Specifications	HI7871	HI7873
Transmission	max 100 m (330')	
Electrical Connection	HI7164 undecal connector (not included)	
Level Adjustment	high and low	high, low and overflow
Level Indication	high and low	high, low and overflow
Sensor Bars	three (not included)*	four (not included)**
Transmitter	HI7874 (not included)	HI7874 (not included)
Output Contact	one relay (2A/250 VAC, 30 VDC)	two relays (2A/250V, 30 VDC)
Power Supply	models "/>	

**Ordering Information**

**HI7871/115** (115V) is supplied with mounting brackets and instructions.  
**HI7871/220** (220V) is supplied with mounting brackets and instructions.  
**HI7873/115** (115V) is supplied with mounting brackets and instructions.  
**HI7873/220** (220V) is supplied with mounting brackets and instructions.  
**HI731324** measuring bar set for level controller  
**HI7874** level Transmitter  
**HI7164** undecal Connector

\*HI7871 requires 3 bars, one each for low and high levels and the third as a consent sensor.  
 \*\*HI7873 requires 4 bars with the additional bar used for overflow measurement.

HI7874

## Level Transmitter

Accurate level control is critical to many industrial applications, especially for process adjustments using aggressive chemicals. Our sensor bars are built with stainless steel for long life, even in harsh conditions. These transmitters are easy to install and ideal for monitoring tanks and water conditioning plants.

The HI7874 transmitter was designed to be used in conjunction with the HI7871 and HI7873 level controllers. The transmitter is housed in a durable and waterproof ABS body and allows the user to easily adjust the length of the sensor bars according to the specific need.

The HI7874 is supplied with a sturdy mounting bracket for quick and easy installation.

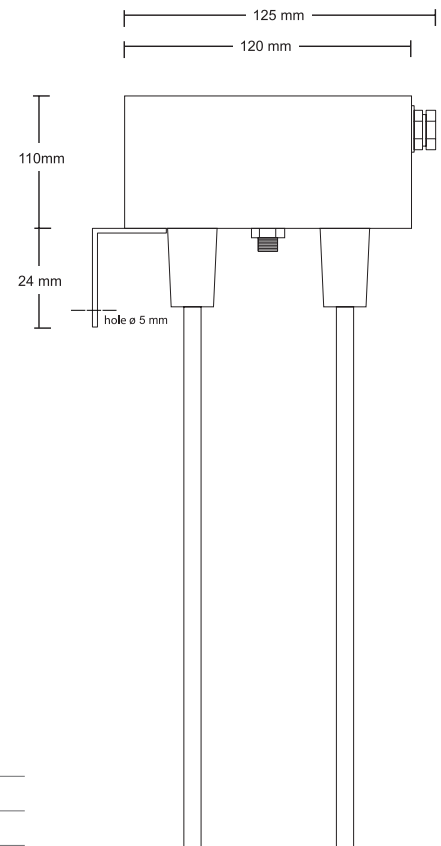
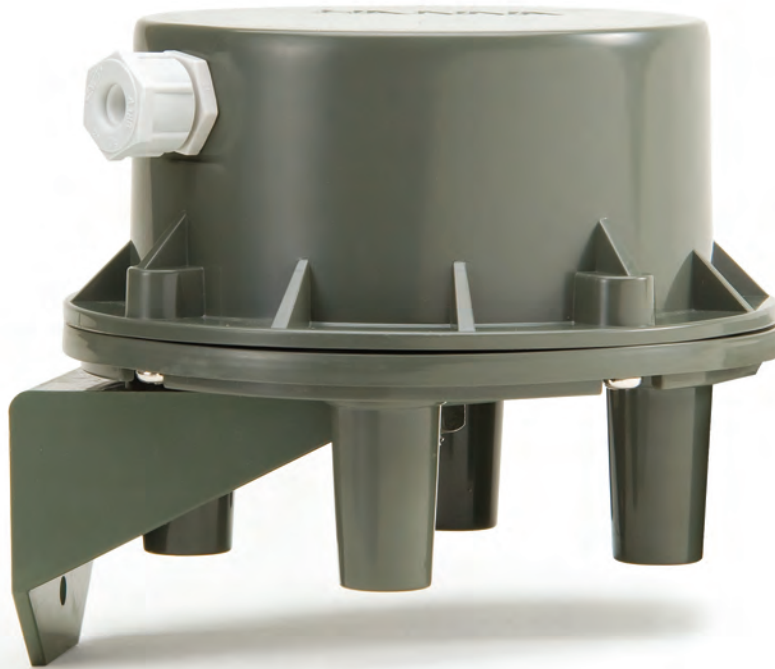

HI7874  
Level Transmitter with HI731324  
Stainless Steel Measuring Bars

### Specifications

### HI7874

Transmission	max 100 m (330')
Electrical Connection	two-wire terminal
Level Adjustment	high, low and over flow
Sensor Bars	three or four (not included)
Power Supply	from level controller
Environment	0 to 50°C (32 to 122°F); RH max 100%
Weight	550 g (1.2 lbs.)
<b>Ordering Information</b>	<b>HI7874</b> is supplied with mounting bracket and instructions. <b>HI731324</b> measuring bar set for level controller

# MEADOS pH and ORP Measuring and Dosing System



## Two Advanced Instruments in One

MEADOS pumps combine the powerful Blackstone dosing pumps with Hanna pH/ORP controllers. This latest innovation eliminates the need for multiple units by combining a pH controller and chemical feed pump into one. No more complicated installations, wiring and compatibility problems. This compact unit features accurate regulation, proportional dosing, alarm and recorder signals and much more, all in one meter.

## Easy Installation

Designed with mounting holes built into a rugged base, Blackstone pump/controllers are simple to install. They use a standard pH probe with a BNC connector to eliminate the need for any additional hardware. All of the controls and pump assemblies are conveniently located on the front of the unit. There is no need to uninstall the unit to access the pump head or control panel.

## Rugged Construction

Blackstone pump/controllers are housed in rugged, fiber-reinforced polypropylene IP55 rated casings to prevent the ingress of liquids. The material used for the housing resists corrosion caused by most chemicals, protecting the unit from hazardous spills and splashes.

## Superior Materials

Blackstone pumps use PVDF, FPM/FKM and PTFE materials for all components in contact with the chemicals being dosed. These materials have properties which enable them to resist even the most corrosive chemicals in the industry. The chemical resistance chart on our BlackStone chemical dosing pumps section shows how well PVDF, FPM/FKM and PTFE resist the harmful effects of different products.

## Simple Pump Action

A positive displacement solenoid with few moving parts makes Blackstone pumps more reliable than motor driven pumps since there is no rotating parts, gears or cams; drastically reducing any chance of mechanical failure.

## Proportional Dosing

The Blackstone controller/pump strokes at full capacity when the measured value deviates by more than 1.5 pH or 150 mV from the set value. A proportional control slows down the stroke rate as the measured value approaches the user selectable set points, avoiding overdosage of chemicals. This feature makes the pump's dosing more accurate, saves chemicals and eliminates unnecessary and costly corrections to your process, especially with slow reacting chemicals.

## Isolated Recorder Output

To enhance troubleshooting and the ability to record data while monitoring, Blackstone controller/pumps provide a recorder output. By simply attaching a recording device to the instrument's 4 to 20 mA output contacts, conveniently located on the front panel, you can obtain a hard copy of the results on demand.

## Alarm Output

When monitoring and controlling pH and ORP levels in a process, it is very important that any potential problem does not go unattended. The Hanna MEADOS units incorporate an alarm system that will alert the user if the reaction is not within certain guidelines. The alarm of the BL7916 will be activated if the measured pH value is 2 pH units lower than the set point (if dosing acid, this indicates overdosage, a common symptom of siphoning). The alarm will also activate if the value is 2 pH higher than the set point (if dosing acid, this is an indication of insufficient dosage, a common symptom of the lack of chemicals). The BL7917's alarm will activate if the mV value is 200 mV lower than the set point (if dosing reducing chemicals, this indicates overdosage). The alarm will also activate if the value is 200 mV higher than the set point (if dosing reducing chemicals, this is an indication of lack of chemicals).

## Auxiliary Dosing Contacts

The auxiliary dosing contacts of the MEADOS units are closed whenever the pump is dosing. This solution offers considerable advantages, especially for small plants, where these pumps need to be the only equipment left running. This will spare other equipment such as mixers, priming pumps etc. With this feature activated, a mixer can be automatically started, when the pump is dosing.

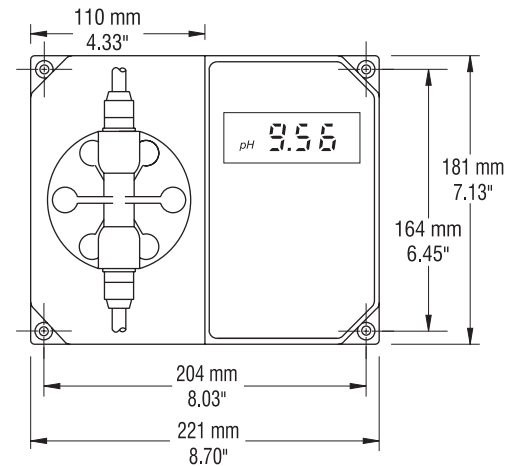

Front View

This series of instruments will mount easily in your plant using a minimum of wall space. The controls and pump head are located in the front to allow easy access.

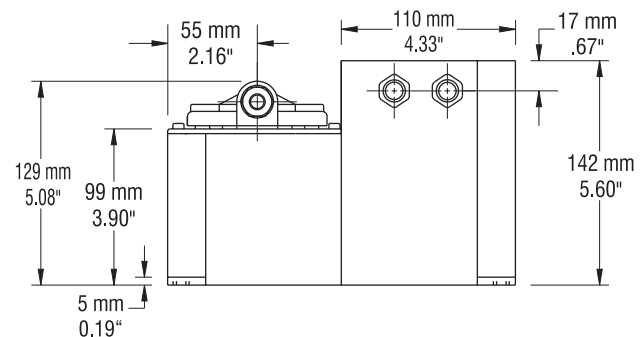

Bottom View

The controller/pump series of instruments are enclosed in a modular housing for maximum protection. These illustrations show the layout of the controller/pumps and how they utilize the one-piece polypropylene, injection-molded housing for rigidity.

## Functional Description for BL7916

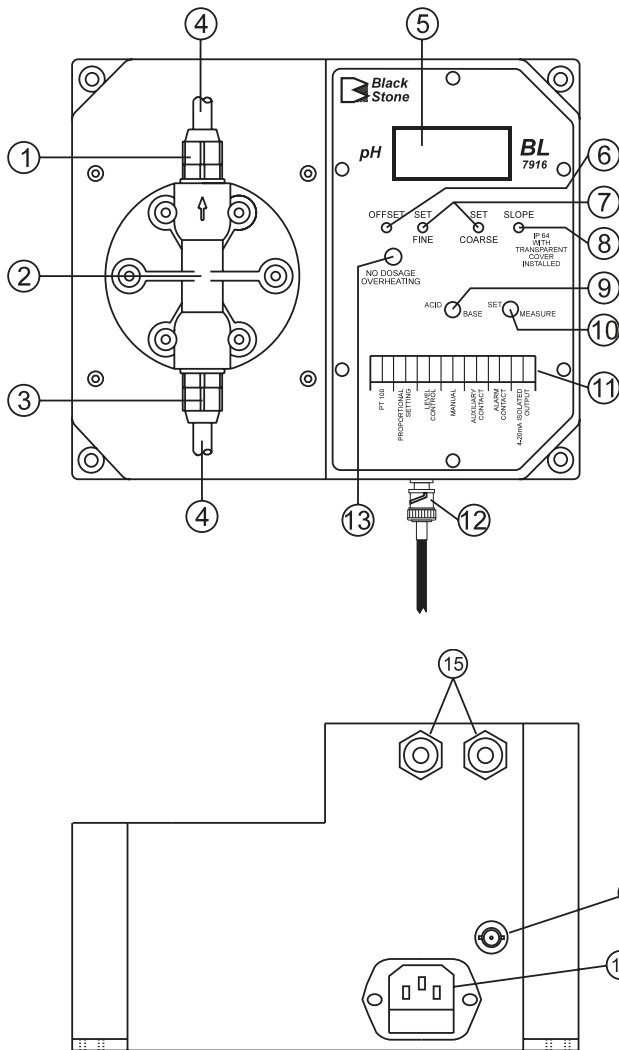

1. Discharge Valve Assembly
2. Pump head
3. Suction Valve Assembly
4. Hose
5. Liquid Crystal Display
6. Offset Calibration Trimmer
7. Setpoint Adjustment Trimmers (FINE and COARSE)
8. Slope Calibration Trimmer
9. Acid/Base Selection Switch
10. Display Mode Selection Switch (SET or MEASURE)
11. Terminal Connections
12. BNC Connector for pH electrode
13. Overheating LED
14. Power Socket and Fuse Holder
15. Cable Glands

## Functional Description for BL7917

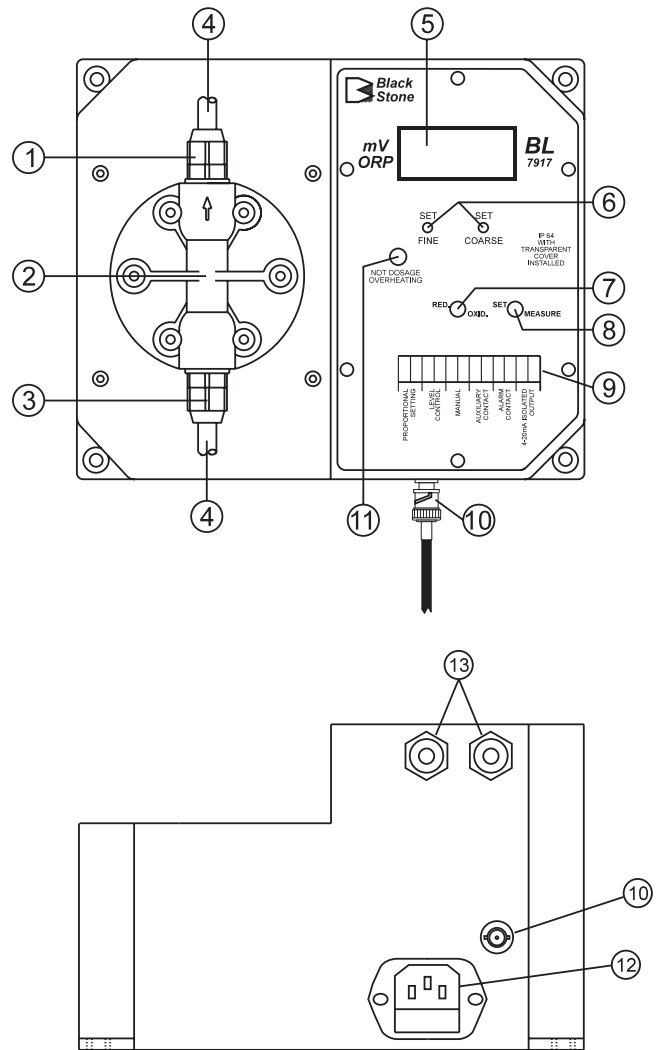

1. Discharge Valve Assembly
2. Pump head
3. Suction Valve Assembly
4. Hose
5. Liquid Crystal Display
6. Setpoint Adjustment Trimmers (FINE and COARSE)
7. Reduction/Oxidation Selection Switch
8. Operating Mode Selection Switch (SET or MEASURE)
9. Terminal Connections
10. BNC Connector for ORP electrode
11. Overheating LED
12. Power Socket and Fuse Holder
13. Cable Glands

BL7916

## pH Controller and Pump

- pH controller and dosing pump
- $\pm 0.01$  pH accuracy
- Isolated 4 to 20 mA recorder output.
- Proportional dosing
  - Slows the pump down when the measured pH level approaches the set value, which ensures precise dosage and avoids costly waste of chemicals due to overdosage.
- Alarm contact
  - Activated whenever the pH value varies more than 2 pH units from the set point.
- Auxiliary contacts
  - Allow the user to attach a mixer or priming pump that is activated only when the pump is dosing.
- PVDF, FPM/FKM and PTFE materials
  - Used for all parts that come into contact with liquid.



 **Black Stone**  
by Hanna

Specifications	BL7916
Range	0.00 to 14.00 pH
Resolution	0.01 pH
Accuracy (@25°C/77°F)	$\pm 0.01$ pH
Flow Rate	see table
Input Impedance	$10^{12}$ Ohm
Dosage	proportional, acid or base, user selectable
Dosing Contact	1 isolated, 2A, max. 240V, resistive load, 1,000,000 strokes
Alarm Contact	1 isolated, 2A, max. 240V, resistive load, 1,000,000 strokes
Calibration	offset: $\pm 1$ pH with trimmer; slope: 85 to 115% with trimmer
Recorder Output	4-20 mA (isolated)
Power Supply	BL 7916-1: 115V $\pm 15\%$ ; 50/60Hz (40W); BL 7916-2: 230V $\pm 15\%$ ; 50/60Hz (40W)
Environment	0 to 50°C (32 to 122°F); RH max 95% non-condensing
Dimensions	221 x 142 x 181 mm (8.7 x 5.6 x 7.1")
Weight	5 kg (11 lb.)
<b>Ordering Information</b>	<b>BL7916-1</b> is supplied with discharge and suction valves, polyethylene tubing, 115V power cable and instructions <b>BL7916-2</b> is supplied with discharge and suction valves, polyethylene tubing, 230V power cable and instructions

### BL7916 PRESSURE/FLOW

BAR (PSI)	LPH (GPH)
0.5 (7.4)	13.3 (3.46)
1.0 (14.7)	11.7 (3.04)
2.0 (29.4)	10.1 (2.63)
3.0 (44.1)	9.0 (2.33)
4.0 (58.8)	7.8 (2.03)



BL7917

## ORP Controller and Pump

- ORP controller and dosing pumps
- $\pm 5$  mV accuracy
- Isolated 4 to 20 mA recorder output.
- Proportional dosing
  - Slows the pump down when the measured ORP level approaches the set value, to avoid over dosage of oxidizing or reducing agents.
- Alarm contact
  - Is activated whenever the ORP reading varies more than 200 mV from the setpoint.
- Auxiliary contacts
  - Allow users to attach a mixer or priming pump that is activated only when the pump is dosing
- PVDF, FPM/FKM and PTFE materials
  - are used for all parts that come into contact with liquid.

### Specifications BL7917

Range	-999 mV to +999 mV
Resolution	1 mV
Accuracy (@25°C/77°F)	$\pm 5$ mV
Flow Rate	see table
Input Impedance	$10^{12}$ Ohm
Dosage	proportional, oxidizing or reducing, user selectable
Dosing Contact	1 isolated, 2A, max. 240V, resistive load, 1,000,000 strokes
Alarm Contact	1 isolated, 2A, max. 240V, resistive load, 1,000,000 strokes
Recorder Output	4-20 mA (isolated)
Power Supply	BL 7917-1: 115V $\pm 15\%$ ; 50/60Hz (40W) BL 7917-2: 230V $\pm 15\%$ ; 50/60Hz (40W)
Environment	0 to 50°C (32 to 122°F); RH max 95% non-condensing
Dimensions	221 x 142 x 181 mm (8.7 x 5.6 x 7.1")
Weight	5 kg (11 lb.)
<b>Ordering Information</b>	<b>BL7917-1</b> is supplied with discharge and suction valves, polyethylene tubing, 115V power cable and instructions. <b>BL7917-2</b> is supplied with discharge and suction valves, polyethylene tubing, 230V power cable and instructions.

### BL7917 PRESSURE/FLOW

BAR (PSI)	LPH (GPH)
0.5 (7.4)	13.3 (3.46)
1.0 (14.7)	11.7 (3.04)
2.0 (29.4)	10.1 (2.63)
3.0 (44.1)	9.0 (2.33)
4.0 (58.8)	7.8 (2.03)



### Two-Wire pH & ORP Transmitters

Two-wire transmitters are widely used for process control in industry. These instruments are particularly useful in industrial conditions where electrical interference is an important factor. By galvanically isolating the signals, any interference created is prevented from reaching the transmitter. Industrial environments are often associated with corrosive conditions, therefore any instrumentation used must be resistant to liquids and corrosion. Hanna transmitters meet all of these criteria and they only use two wires which reduces costs and eliminates the need for an expensive coaxial cable. Two-wire transmitters are ideal when used in remote applications that do not have AC power available.

As technology advances it is becoming more important to monitor certain processes closely, particularly from remote locations. Computers are commonly used to receive signals from transducers that have travelled a great distance (up to 300 meters, 1000'). When transmitting signals over such a distance, it is likely that a substantial portion of the signal will be absorbed by the resistance of the lines. Considerable differences in ground potentials and between the signal source and load, are inherent to long lines.

Powering the system with an AC supply is beneficial in eliminating this problem. One of the two wires is power ground return, while the other is the power supply. The power supply line acts in a dual manner, as a power supply, and as a signal carrier. This allows the transmitter to operate with 2 wires.

The signal current from the process controller is normally 4 to 20 mA. When the load is connected with the power supply return line, the signal current will be proportional in the range of 4 to 20 mA.

The ability to use a thinner gauge of wire greatly reduces the costs associated with the wiring of remote transmitters. Typically, a heavy gauge of shielded cable is required in order to minimize the ambient electrical noise from AC power sources, interference from electrical equipment, or various other sources of noise.

Thin wire will also provide better operation when the transmitter current output is a 4 to 20 mA signal. All of these features and many more, give Hanna transmitters the versatility to be used over long distances in almost any process control application.

### Conductivity, Four-Ring Technology

Hanna conductivity transmitters use four-ring Potentiometric probes. As opposed to the more widely used 2-electrode Amperometric method, the four-ring Potentiometric method provides the highest accuracy and repeatability attainable. When measuring liquids that have a high conductivity, the 2-electrode system is susceptible to polarization. This condition makes it exceptionally difficult to obtain measurements with any accuracy. The polarization is directly related to the electrode's current load, and will cause a considerable, nonlinear drop in the voltage. As a result, the solution around the electrode simulates a low conductivity condition.

Four-ring electrodes eliminate the polarization effect by splitting the four rings into 2 current and 2 voltage electrodes. When placed in a conductive liquid, the 2 current electrodes take the alternating voltage and create a current. This alternating current produces a buffer field from which polarization is absent. The voltage is then measured in this field assuring no altered readings.



HI98143

## pH and EC Transmitter

with Galvanic Isolated Output

- ATC
  - Automatic temperature compensation Connectivity
- PC compatible

The HI98143 series is designed to accept signals directly from a pH electrode and a conductivity probe at the same time.

Direct connection of the probes to the transmitter assure a positive electrical connection with no signal loss. This transmitter is ideal for remote process control applications.

Four models are available, transmitting a 0-1 V, 0-4 V or 4-20 mA signal. The output signals are proportional to the input signals but independent of changes in load or cable capacitance. Compensation for the effects of temperature for EC measurements are performed by the transmitters' Automatic Temperature Compensation circuitry.

The transmitter can be connected to any pH or conductivity controller, recorder, PC or any data monitoring device that accepts 0 to 1 V, 0 to 4 V or 4 to 20 mA input. HI98143 is an ideal tool for applications that require the monitoring of both pH and conductivity at the same time.



Specifications	HI98143-01 • HI98143-04 • HI98143-20 • HI98143-22
Range	0 to 14 pH; 0 to 10 mS/cm
Accuracy (@25°C/77°F)	±0.5% f.s. pH; ±2% f.s. EC
Calibration	manual, 2 point, through trimmers: pH: offset and slope trimmers; EC: 0 and 5 mS/cm trimmers
EC Temp. Compensation	automatic, 0 to 60°C (32 to 132°F) with $\beta=2\%/^{\circ}\text{C}$
pH Electrode	HI1001 pH electrode (suggested, not included), HI1283 matching pin (not included)
EC Probe	HI3001 (not included) with cell constant 2.1
Casing	IP54
Power Supply	12-24 VDC
Environment	0 to 50°C (32 to 122°F); RH max 95% non-condensing
Dimensions	160 x 105 x 31 mm (6.3 x 4.1 x 1.2")
Weight	280 g (9.9 oz.)
Ordering Information	<p>All <b>HI98143</b> models are supplied with instructions.</p> <p><b>Choose your configuration</b></p> <p><b>HI98143-01</b> pH/EC transmitter with 0-1 V isolated output</p> <p><b>HI98143-04</b> pH/EC transmitter with 0-4 V isolated output</p> <p><b>HI98143-20</b> pH/EC transmitter with 4-20 mA isolated output</p> <p><b>HI98143-22</b> pH/EC transmitter with 4-20 mA isolated output (specific for HI8000 controllers)</p>

HI8614N · HI8614LN · HI8615N · HI8615LN

## pH and ORP Transmitters

with 4-20 mA Galvanically Isolated Output

- **ATC for pH models**
  - Automatic temperature compensation
- **Waterproof**
  - Water resistant
- **Backlight**
  - Backlit, LCD display for "L" models

The HI8614N and HI8614LN are a water-resistant pH transmitters designed to be used with a standard high impedance pH probe with BNC connector. The signal is then processed by a special high impedance amplifier, which transmits an output current directly proportional to the input signal but independent of changes in load or cable capacitance.

These transmitters can be connected to Hanna controller HI8510, HI8710 or HI8711, recorders, computers or any data monitoring device that accepts 4 to 20 mA input.

HI8615N and HI8615LN have been designed for transmitting ORP measurements from remote locations. These transmitters features two controls (one for 4 mA and one for 20 mA) to compensate for electronic drift and ambient temperature.

These transmitters can be connected to Hanna HI8512, HI8720, or any recorders, computers or any data monitoring device that accepts 4 to 20 mA input.

"L" versions allow easy verification and monitoring of measured values and is easier to calibrate and maintain.



HI8614N without LCD



HI8614LN with LCD

Specifications	HI8614N • HI8614LN	HI8615N • HI8615LN
Range	0.00 to 14.00 pH; 4-20 mA	±1000 mV; 4-20 mA
Resolution (for "L" models)	0.01 pH; 0.01 mA	1 mV; 0.01 mA
Accuracy (@25°C/77°F)	±0.02 pH; ±0.02 mA	±5 mV; ±0.02 mA
Calibration	offset: ±2 pH; ±2.2 mA; slope: 86 to 116%; ±0.5 mA	offset: ±100 mV; ±0.8 mA slope: 90 to 110%; ±0.8 mA
Temperature Compensation	fixed or automatic from 0 to 100°C (32 to 212°F) with Pt100 probe	-
Input Impedance	10 <sup>12</sup> Ohm	
Recorder Output	4-20 mA (isolated)	
Protection	IP65	
Power Supply	HI8614N: 18-30 VDC; HI8614LN: 20-36 VDC	HI8615N: 18-30 VDC; HI8615LN: 20-36 VDC
LCD display	only for HI8614LN	only for HI8615LN
Load	max 500 Ohm	
Environment	0 to 50°C (32 to 122°F); RH max 95% non-condensing	
Dimensions	165 x 110 x 71 mm (6.5 x 4.3 x 2.8")	
Weight	1 kg (2.2 lb.)	
<b>Ordering Information</b>	<b>HI8614N</b> and <b>HI8614LN</b> (with display) is supplied with instructions.	<b>HI8615N</b> and <b>HI8615LN</b> (with display) is supplied with instructions.



ALN, BLN, CLN, and DLN with LCD

## HI8936 Series

## Conductivity Transmitters

to use with Four-ring Probe

- **ATC**
  - Automatic temperature compensation
- **Backlight**
  - Backlit, LCD display

HI8936 is a conductivity transmitter that utilizes a four-ring potentiometric probe. This probe is virtually immune to contamination by unclean solutions. This allows the transmitter to operate at peak performance at all times.

Temperature effects are compensated for by utilizing both the built-in temperature sensor on the probe and the transmitter's ATC circuitry with a d of 2%/°C.

Direct connection of the probe to the transmitter assures a positive electrical connection with no signal loss over long distances.

HI8936 "L" versions allow easy verification and monitoring of measured values and is easier to calibrate and maintain.

The HI8936 series requires external power to the 4-20 mA current loop.

*The HI8936 series should be used in conjunction with the HI7635 in-line probe or HI7638 platinum probe (see Process Electrodes and Probes).*

Specifications	HI8936AN HI8936ALN	HI8936BN HI8936BLN	HI8936CN HI8936CLN	HI8936DN HI8936DLN
Range	0.0 to 199.9 mS/cm	0.00 to 19.99 mS/cm	0 to 1999 µS/cm	0.0 to 199.9 µS/cm
Resolution	0.1 mS/cm	0.01 mS/cm	1 µS/cm	0.1 µS/cm
Accuracy	±2% f.s. (excluding probe error)			
Calibration	manual, two point, with offset and slope trimmers			
Temperature Compensation	fixed or automatic with NTC sensor from 0 to 50°C (32 to 122°F) with $\beta=2\%/^{\circ}\text{C}$			
Conductivity Probe	HI7635 for in-line applications (not included)			
Recorder Output	4-20 mA, not isolated, max 500 Ohm			
Protection	IP65			
Power Supply	without LCD: 12-30 VDC; with LCD: 17-36 VDC			
LCD Display	HI8936AN: no HI8936ALN: yes	HI8936BN: no HI8936BLN: yes	HI8936CN: no HI8936CLN: yes	HI8936DN: no HI8936DLN: yes
Environment	0 to 50°C (32 to 122°F); RH max 95% non-condensing			
Dimensions	165 x 110 x 71 mm (6.5 x 4.3 x 2.8")			
Weight	1 kg (2.2 lb.)			
<b>Ordering Information</b>	All <b>HI8936</b> models are supplied complete with instructions.			



AN, BN, CN, and DN without LCD

# BlackStone Chemical Dosing Pumps

## Versatility

BlackStone pumps have been designed to meet the ever changing needs of industry. With their broad, flat base and mounting holes for tank, shelf or floor mounting (horizontal), the pumps can be easily mounted anywhere in your plant. The rear of the pump housing also provides mounting holes to facilitate vertical mounting: wall, tank or machine. Since the pump valve assembly and controls for the unit are located on the front of the pump, there is never a problem with installation or flow adjustments.

## Simple Operation

BlackStone pumps are equipped with a single control for pump output. The external flow rate control (potentiometer) on the face of the pump allows you to adjust the percentage of flow from 0 to 100% of the pump's rated capacity. This feature eliminates the need to worry about stroke lengths and power settings. An LED indicator lights up each time a stroke begins, allowing the user to assess the stroke rate from a distance.

## High Quality Materials

BlackStone pumps have been manufactured with the highest level of mechanical precision from materials chosen for their inherent ability to resist the effects of aggressive chemicals. When you select a Blackstone pump, you are eliminating the time consuming effort involved in picking the right material for your application. Blackstone pumps are supplied with the highest quality material as standard equipment—not optional. The diaphragm utilizes one-piece construction of PTFE, which unlike conventional laminated diaphragms, will stand up to the test of time and wear. Ball valves are constructed in glass.

The pumphead and O-rings are made of PVDF, PTFE and FPM/FKM which offer unsurpassed resistance. The chemical resistance chart (right) shows how well PVDF and PTFE stand up to some of the most aggressive chemicals.



## Chemical Resistance Guide\*

Chemical	PVC	PP	Hypalon	FPM/ FKM	PVDF	PTFE
Acetic Acid, 80%	D	B	A	E	A	A
Bleach	A	B	A	A	A	B
Citric Acid	A	A	A	A	A	A
Copper Cyanide	A	A	X	B	A	A
Copper Sulfate	A	A	B	B	A	A
Ferric Chloride	A	A	B	B	A	A
Ferric Sulfate	A	A	B	B	A	A
Hydrazine	X	X	B	B	A	A
Hydrochloric Acid (concentrated)	A	A	B	B	A	A
Hydrochloric Acid (diluted)	A	A	B	B	A	A
Hydrofluoric Acid (diluted)	D	B	D	A	A	A
Hydrogen Sulfide	C	A	B	B	A	A
Magnesium Nitrate	A	A	A	A	A	A
Magnesium Sulfate	A	A	A	A	A	A
Nitric Acid, 50%	A	C	E	A	A	A
Phosphoric Acid	B	B	A	B	A	A
Plating Baths	A	A	C	A	A	A
Potassium Cyanide	A	A	B	B	A	A
Potassium Nitrate	A	A	B	B	A	A
Propyl Alcohol	C	X	B	B	A	A
Soaps	A	A	B	B	A	A
Sodium Bicarbonate	A	A	A	A	A	A
Sodium Bisulfite	A	A	A	A	A	A
Sodium Hydroxide, 50%	A	A	B	E	A	A
Sodium Hypochlorite, 18%	A	A	A	D	A	A
Sulfuric Acid (concentrated)	A	A	B	A	A	A
Tanning Reagents	A	A	A	X	A	A
Trichlorethane	E	C	E	A	A	A

\* PARTIAL LISTING

### Symbol Key

A - Excellent      B - Good      C - Fair      D - Acceptable (limited use)      E - Not recommended      X - Unknown

## BL Series Dosing Pumps

BlackStone's positive displacement solenoid driven pumps use a minimum number of moving parts, therefore reducing the chance of mechanical failure. Part wear and oiling associated with motor driven pumps (ball-bearings, gear drives and cams) are not a concern with these pumps. Blackstone pumps are more accurate than standard pumps due to the positive displacement design ensuring each stroke is identical to the strokes before and after it, thus keeping the flow rate consistent.

A wide range of BlackStone pumps with different dosing capacities are available for your specific dosing needs. Each pump is supplied with discharge and suction valves.

### Rugged Design

Blackstone pumps are completely sealed during assembly and offer IP65 protection against splashes and spills providing excellent protection even in hostile environments. The fiber-reinforced polypropylene housing stands up to aggressive chemicals while offering superior strength under tough industrial conditions.

### Typical Installations

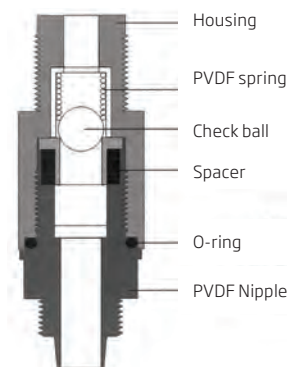
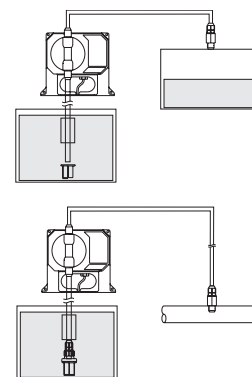

Part Number	Max Output	Rated Pressure	Dosing Frequency strokes/min
With Large Diaphragm			
BL20	18.3 lph (4.8 gph)	0.5 bar (7.4 psi)	120
BL15	15.2 lph (4.0 gph)	1 bar (14.5 psi)	120
BL10	10.8 lph (2.9 gph)	3 bar (43.5 psi)	120
BL7	7.6 lph (2.0 gph)	3 bar (43.5 psi)	120
With Small Diaphragm			
BL5	5.0 lph (1.3 gph)	7 bar (101.5 psi)	120
BL3	2.9 lph (0.8 gph)	8 bar (116 psi)	120
BL1.5	1.5 lph (0.4 gph)	13 bar (188.5 psi)	120

Specifications	BL Series
Max Output	see table above
Pump Casing	fiber-reinforced polypropylene
Materials	pumphead in PVDF, diaphragm in PTFE, glass ball valves and O-rings in FPM/FKM, polyethylene 5 x 8 mm tubing
Self-priming	max height: 1.5 m (5 feet)
Power Supply	110/115 VAC or 220/240 VAC, 50/60Hz
Max Power Consumption	approximately 200 W
Protection	IP65
Environment	0 to 50°C (32 to 122°F); RH max 95% non-condensing
Dimensions	194 x 165 x 121 mm (7.6 x 6.5 x 4.8")
Weight	approx. 3 kg (6.6 lb.)

### Ordering Information

<b>BL1.5-1</b>	1.5 LPH flow rate	<b>BL7-2</b>	7.6 LPH flow rate
<b>BL1.5-2</b>	1.5 LPH flow rate	<b>BL10-1</b>	10.8 LPH flow rate
<b>BL3-1</b>	2.9 LPH flow rate	<b>BL10-2</b>	10.8 LPH flow rate
<b>BL3-2</b>	2.9 LPH flow rate	<b>BL15-1</b>	15.2 LPH flow rate
<b>BL5-1</b>	5.0 LPH flow rate	<b>BL15-2</b>	15.2 LPH flow rate
<b>BL5-2</b>	5.0 LPH flow rate	<b>BL20-1</b>	18.3 LPH flow rate
<b>BL7-1</b>	7.6 LPH flow rate	<b>BL20-2</b>	18.3 LPH flow rate

-1 = 110/115 VAC power supply  
-2 = 220/240 VAC power supply

### Accessories

<b>HI721004**</b>	Injection valve assembly
<b>HI721005**</b>	Foot valve assembly
<b>HI721101</b>	Pumphead, O-ring, screws and washer
<b>HI721102</b>	Discharge valve assembly
<b>HI721103</b>	Suction valve assembly
<b>HI721008</b>	Ceramic weight (4)
<b>HI721104</b>	Small diaphragm for BL pumps
<b>HI721106</b>	BlackStone pump head assembly

\*\* Required for operation

## Assembly Diagram

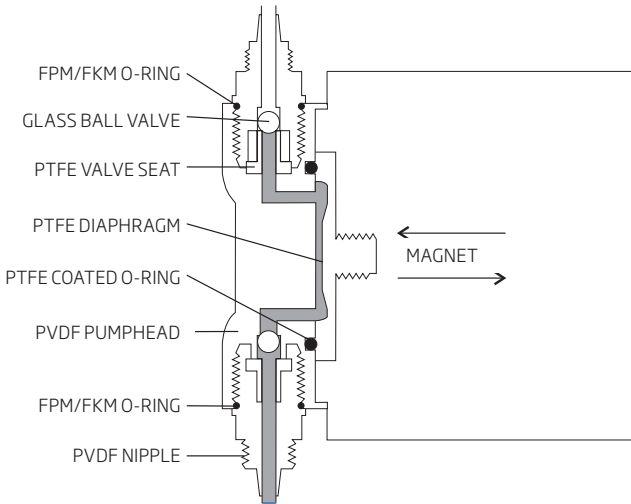
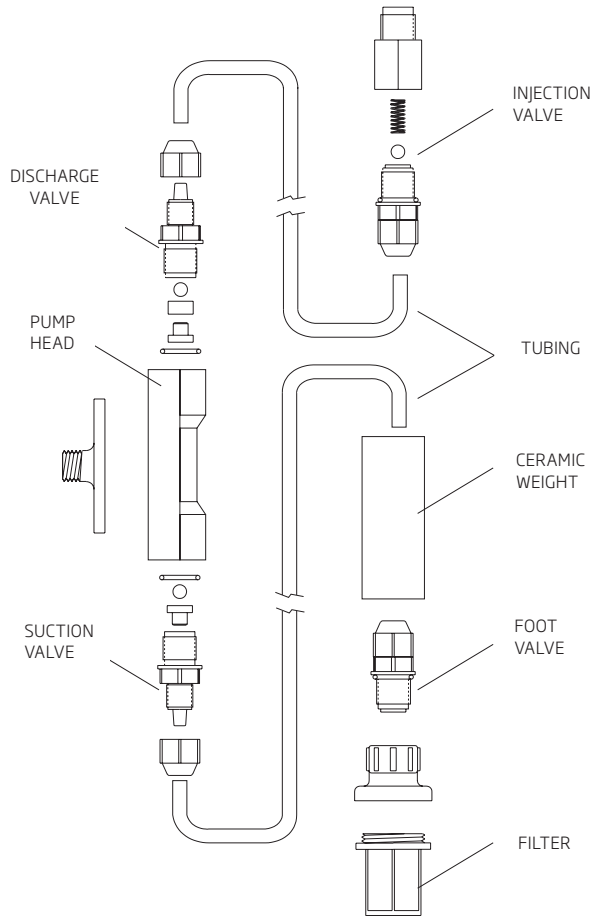

Front View

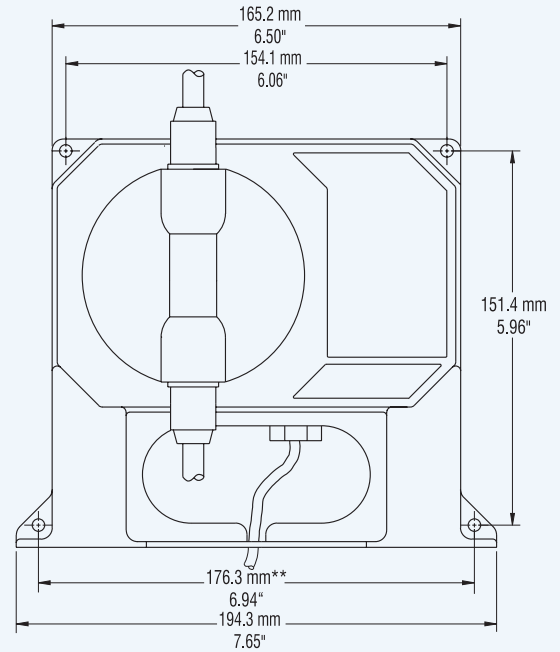

\*\* Dimensions for floor and wall mounting

Side View

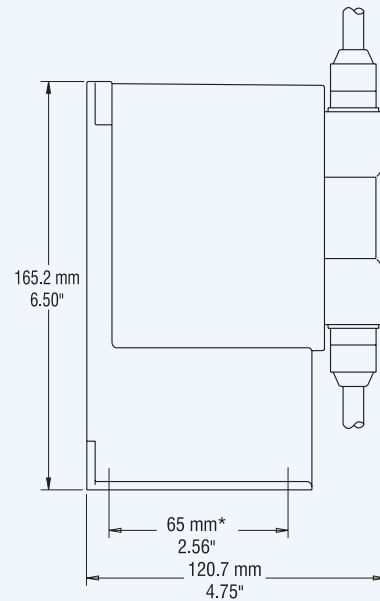

\* Dimensions for floor mounting

HI721101

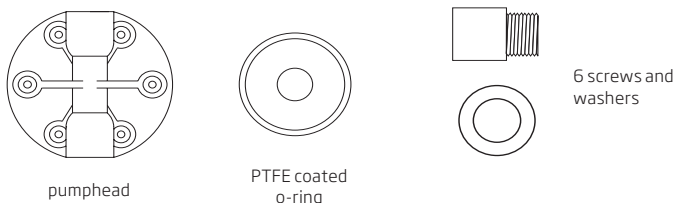

Ordering Information

HI721101

This kit contains the PVDF pumphead, PTFE coated O-ring, 6 screws and washers.

HI721102

This kit contains all the necessary replacement parts for your discharge valve assembly. Complete with a FPM/FKM O-ring, glass valve ball, the valve spacer and seat, head nipple and the tube nut to secure the assembled parts.

HI721102

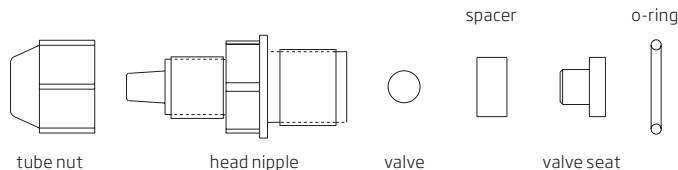

HI721103

Suction valve assembly, complete with a FPM/FKM O-ring, glass valve ball, the valve spacer and seat, head nipple and the tube nut to secure the assembled parts.

HI721004

Complete with an injection nipple, PTFE coated spring, glass valve ball and a valve assembly.

HI721103

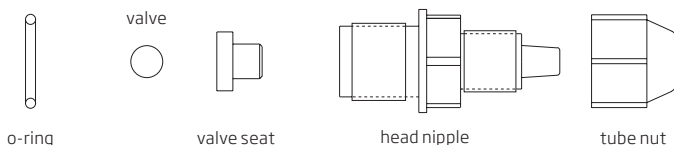

HI721005

This kit contains a filter with a filter holder and a valve assembly.

HI721003

This kit contains 10 glass balls and 10 valve O-rings.

HI721004

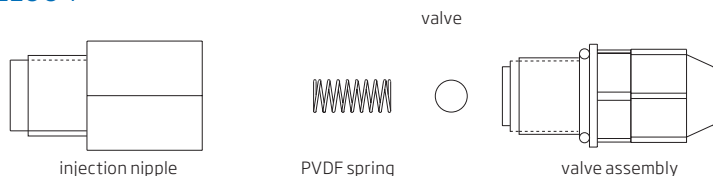

HI721006

This kit contains 4 PVDF springs.

HI720029

LDPE hose, 3 m (9.9').  
Inside diameter 4.71 mm  
Outside diameter 7.87 mm

HI720030

LDPE hose, 10 m (33').  
Inside diameter 4.71 mm  
Outside diameter 7.87 mm

HI721005

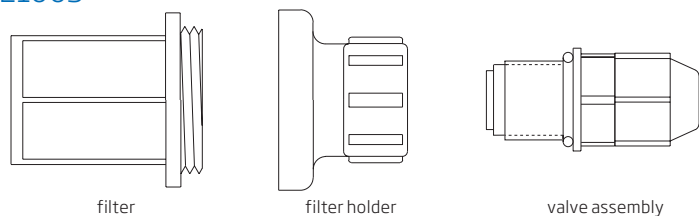

HI720031

LDPE hose, 50 m (165').  
Inside diameter 4.71 mm  
Outside diameter 7.87 mm

HI720032

LDPE hose, 100 m (333').  
Inside diameter 4.71 mm  
Outside diameter 7.87 mm

HI721008

This kit contains 4 ceramic weights.

HI721003



HI721006



HI720032

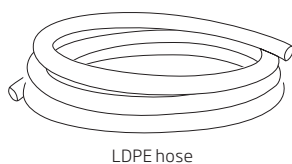

HI721008

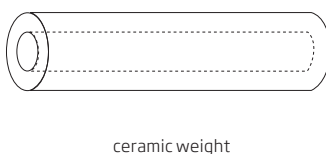

# Process Electrodes

## A Worldwide Leader in Electrode Manufacturing

Since the beginning of the 1990's Hanna has been a leader in the research & development of pH and ORP electrodes. Today, Hanna is proud to present the latest family of industrial electrodes, the Flat Tip Series, which completes the wide range of Hanna probes for any process application. All Hanna industrial pH and ORP electrodes are combination type, i.e. the reference half cell and the measurement half cell are assembled in the same body.

## Industrial Electrodes and Probes



HI1000/Hi2000 Series



Standard

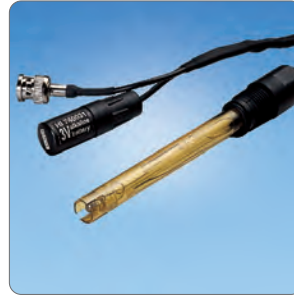

AmpHel



Flat Tip

## Reference Half Cell

The reference half cell provides a known and stable reference potential. During the normal electrode life span, this potential can vary, possibly signaling the end of the electrode's life.

- The main causes of reference potential variation are:
  - Electrolyte contamination
  - Dilution
  - Electrochemical reaction
  - Junction clogging

As a result of many years of experience and electrode testing in industrial applications, Hanna has found the solutions for all these challenges.





## Electrolyte Contamination

The contamination of the reference half cell is linked to the diffusion of external substances into the reference chamber (strong oxidants, reductants, complexing agents).

The combination of Hanna double junction technology with a polymer reference electrolyte, reduces the diffusion process rate and keeps the reference potential stable for long periods of time.

## Dilution

When the reference cell containing concentrated 3.5M KCl electrolyte comes in contact with a less concentrated aqueous sample, diffusion of the electrolyte into the sample will occur. This process causes a progressive dilution of the reference electrolyte with a consequent variation of the reference potential.

Hanna double junction technology and the use of a large electrolyte volume (up to three times greater than traditional electrodes) makes this dilution effect negligible.

## Electrochemical Reaction

In many industrial applications, it is possible to get a potential difference between the measuring point and the instrument. This inconvenience originates from electrical currents that destroy the Ag/AgCl element of the reference half-cell and also creates non-stable, interfering potentials.

Hanna's simple and effective solution to this challenge is the matching pin built-in to each industrial electrode. The matching pin is a stainless steel or titanium element that is connected to the instrument to prevent grounding problems, and to prolong electrode life.

## Junction Clogging

Typical industrial applications require continuous monitoring of pH and ORP. Periodic cleaning and maintenance of the electrode junction ensure a stable and repeatable contact between sample and junction. The frequency of these cleaning procedures depends on the shape of the junction and material.

Hanna industrial electrodes are provided with different types of junctions. In particular, the porous PTFE junction used for the flat tip electrodes, which can provide optimum performance for months without requiring any maintenance.

## Measurement Half Cell

All Hanna industrial pH electrodes include a measurement cell with a glass sensor. A glass sensor is the only answer for most industrial requirements. Below is a list of the main causes of shortened glass sensor life, for which Hanna has developed different types of specialized glass:

- High temperature
- Low temperature
- Acid samples containing fluoride



# Process Electrodes

## Built for Everyday, Demanding Use

Hanna provides glass sensors that are able to withstand the previously listed industrial environmental challenges.

Glass Type	Application	pH Range	Temperature Range
LT	low temperature	0 to 12	-10 to 80°C
HT	high temperature	0 to 14	0 to 100°C
HF	acid samples with fluoride	0 to 10	-5 to 60°C

## Mechanical Stress

In a continuous in-line installation, the glass sensor of the pH electrode can be physically damaged by solution streams containing suspended solids.

Our Flat Tip electrodes are the best answer to this problem. The flat tip virtually eliminates deposits that can foul the electrode, significantly reducing necessary maintenance.

## Flat Tip Advantages

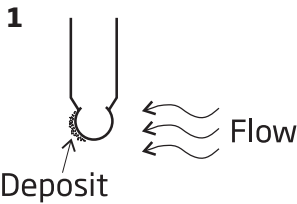

**1**  
An exposed electrode surface will foul and require frequent cleaning

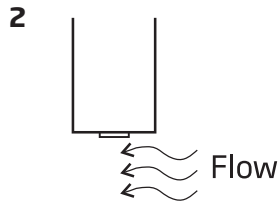

**2**  
The flat shape of the electrode tip nearly eliminates deposits

## Electrode Body Material: Glass, PVDF or PEI



### Glass

The glass body electrode can withstand high pressure and high temperature applications. The glass body also offers high resistance to aggressive chemicals (only fluoridic acid and strong alkaline solutions can damage glass).



### PVDF

The PVDF body used for the Flat Tip Series withstands high pressure and high temperature applications, and guarantees a high chemical and mechanical resistance. These characteristics makes the PVDF material the most recommended for many industrial applications. PVDF is also non-toxic and compatible with food applications.



### PEI

PEI is a special plastic material used first to produce electrodes by Hanna. PEI electrodes proved to be ideally suited to field applications, as well as industrial environments. An electrode with a PEI body represents a very good combination of chemical, mechanical, and thermal resistance which can be used in non-critical applications (e.g. swimming pools), or with portable meters for routine field monitoring and control, such as wells, lakes and rivers, and discharges of tanks and reservoirs.



### AmpHel: Why and Where to Use It

pH electrode glass sensors have a high impedance of typically 100 Mohm, but can reach 800 Mohm depending on the temperature. This is a very weak signal available for accurate measurements. Impedance this high is difficult to handle especially between the electrode and the instrument. Normally this distance is covered by special cables with very high shielding and electrical insulation. Even with these cables, distances cannot be longer than 5 meters.

In industrial installations it is not easy to limit the distance between the electrode and the measuring instrument to 5 meters. Quite often, the recording instruments are located in separate areas from where the pH is measured. To avoid this limitation, a pH amplifier can be used.

Amplifiers are usually available with water-tight casings and can be used under extremely harsh conditions. The pH amplifier needs a power supply and usually must also provide for galvanic insulation between the power supply and the amplification circuit. At times it is difficult to have a power supply close to the measuring electrode. In such a case, 2-wire amplifiers and a 4-20 mA output can solve the problem (see HI8614 and HI8614L produced by Hanna).

Such amplifiers need instruments with 4-20 mA input in place of, or in parallel with, the BNC connector (some instruments are not provided with this option).

To overcome the instrument limitation, in 1988, Hanna produced the AmpHel electrode (Amplified pH electrode). The AmpHel electrodes feature an internal, high impedance pH amplifier with the required batteries.

An AmpHel electrode has a life of approximately 3 years from the day it was produced. Taking into consideration that an average life for a pH electrode is one year, this should not be considered a limitation.

The output is still with 2 wires, as in the case of the typical coaxial cable, but it has a low impedance, and allows connections up to 75 meters long without delays in the measurements.

### Cable Leakage

A high impedance coaxial cable, when installed more than 5 meters away from the electrode, could also be subject to current leakage. Quite often the installers place it in underground ducts as done with any other electric cable. During the installation of the cable, the insulation may become scratched by rubbing against the pipes or sharp corners. Underneath the insulation there is a screen connected to the reference electrode.

If the cable is in an underwater duct, it could happen that, sometime during the year, the reference electrode (the screen) could come into contact with the humid environment and, thus, with the grounding circuit of the electrical installations. Under these conditions, the pH electrode cannot take reliable measurements and can give erroneous readings. Without any reference to the measurement, the actual reading can be many pH units off. This is another solid reason for avoiding cables longer than 5 meters.



### Electrode-Cable Connection

Some German manufacturers have produced pH electrodes with a coaxial connector mounted directly at one end of the electrode, i.e. without cable. The intention was to replace the electrode, without having to replace the connecting cable which remains attached. But as time passed, such an intention has proven to be harmful.

In fact, in many cases, the electrode is placed inside an electrode holder, which protects it from test liquid (tank measurement). Moisture forms inside the holder because of temperature changes from day to night. This moisture reduces the connector insulation, and the signal to the electrode drops.

When an electrode leaks, the generated emf drops and the reading drifts toward the pH 7 value. Therefore, for example, instead of pH 3, the measurement can be pH 3.5 or 4. This reading may result in a dosage that is harmful to the system.

# Process Electrodes

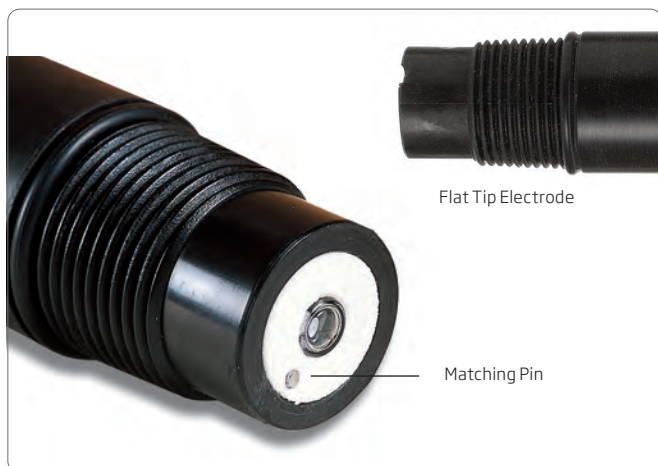

## Potential Matching Pin

In many industrial applications, especially in plating baths, grounding loop current is a very common problem.

When a traditional electrode/controller system is used with the electrode reference connected both to the electrode and to the instrument, a current flow occurs through the reference half cell, causing fluctuations in reading and serious damage to the Ag/AgCl element. The potential matching pin shields the reference from external electrical fields. Shown above, the matching pin allows the measurement to stabilize and ensures effective process regulation. In order to function properly, the matching pin has to be continuously immersed in the measured solution and for this reason is placed near the electrode junction.

## Temperature Effect

Sample temperature is an important parameter for solutions with a pH different from 7.0. In fact at pH 7.0, temperature compensation is not required.

Due to a built-in temperature sensor, there is only one electrode to install. Also due to its proximity to the pH sensor, the built-in temperature sensor ensures fast, accurately compensated readings even during sudden temperature fluctuations.

## A Specific Electrode for Each Application

The table to the right lists the most common industrial applications with the corresponding, recommended Hanna electrodes.

For each application, several models are available, with different options for the following characteristics:

- Electrode dimensions
- Connection type
- Installation requirement
- Optional configurations (matching pin, Pt100 or Pt1000 sensor)

Hanna produces a wide range of industrial electrodes, for any specific application need.

## Common Industrial Applications

Application	pH Electrode Series	Code
Domestic Wastewater Sewage, Septic Tank Treatment	easy	HI1090B/5
	flat tip	HI1006-2005
Industrial Wastewater	HI1000	HI1003/5
	easy	HI1210B/5
	flat tip	HI1006-2005
Food Industry (Beer, Jam, Dairy Products)	easy	HI1090B/5
	flat tip	HI1006-2005
Chemical Neutralization	easy	HI1210B/5
	flat tip	HI1006-2005
Potable Water ( $>400\mu\text{S}/\text{cm}$ )	HI1000	HI1001
	easy	HI1210B/5
	AmpHel	HI6291005
Cooling Towers	HI1000	HI1002/5
	easy	HI1210B/5
	flat tip	HI1006-2005
Water Softening	AmpHel	HI6291005
	HI1000	HI1001/5, HI1002/5
	easy	HI1210B/5
Demineralization	flat tip	HI1006-2005
	easy	HI1090B/5
Low Conductivity Solutions	flat tip	HI1006-2005
Swimming Pools	flat tip	HI1006-2005
Sea Water	easy	HI1090B/5
Galvanic Baths	flat tip	HI1006-3005
	AmpHel	HI8299505
	HI1000	HI1003/5
Sugar Industry, Paper Industry	easy	HI1210B/5
	flat tip	HI1006-2005
Textile Industry, Tanneries	easy	HI1090B/5
	flat tip	HI1006-3005
Acid Samples with Fluoride Ions	AmpHel	HI8299505
	flat tip	HI1006-4005

Application	ORP Electrode Series	CODE
Oxidation of Cyanide and Nitrite	flat tip	HI2004-2005
Ozonization & Oxidant Products	AmpHel	HI6493005
Reductant Products (Chromate Reduction)	AmpHel	HI6293005
	HI2000	HI2003/5
	easy	HI3210B/5
Swimming Pools	HI2000	HI2001, HI2003/5
	easy	HI3210B/5

# Flat Tip Industrial Electrodes

Select the flat tip electrode that best fits your process requirements by choosing from the following technical characteristics:

## 1. Junction

Three junction types are available:

- Annular non-clogging PTFE junction, for testing solutions with high content of suspended solids or for high pressure installation
- Open junction, ideal for wastewater analysis
- Ceramic junction

## 2a. pH Electrodes

Hanna has developed four types of specialized glass. First is a durable sensor glass for general purpose, industrial use. This glass can withstand the stress of daily use. The remaining types of electrode glass allow continuous monitoring in highly acidic solutions containing fluoride ions, as well as high or low temperature process and streams significantly increase the electrode life.

## 2b. ORP Electrodes

ORP electrodes are provided with a platinum sensor for most applications, while a gold sensor is required for measurement of cyanide or highly oxidative environments.

## 3. Temperature Sensor

The pH electrodes with built-in 3-wire Pt100 or Pt1000 temperature sensor allow for the temperature compensation of pH readings as well as temperature measurements.

## 4. Connection Type

Electrodes are wired for direct connection to a transmitter or process controller, or with the standard BNC connector.

## 5. Built-in Amplifier

Models with a built-in amplifier are necessary for long distance measurements, where it is not possible to install a transmitter.

The internal amplifier can be powered directly from select Hanna process controllers or a power source that supplies the appropriate voltage.

## 6. Cable Length

Non-amplified electrodes are provided with a 5, 10 or 15 m cable (16', 33' or 49'), while the amplified models are provided with a 15, 25, 50 or 75 m cable (49, 82, 164 or 246').



- Self-cleaning flat tip sensor
- Significantly reduced maintenance requirement
- Models especially designed for plating baths
- PVDF body
- Three junction types: ceramic, PTFE and open
- Built-in potential matching pin
- Three different glass type pH sensors
- ORP electrodes with platinum or gold sensor
- Models with built-in Pt100 or Pt1000 temp. sensor
- Internal amplifier models powered by the process controller
- 3/4" NPT external thread on both ends for easy installation

Hanna presents a series of combination pH and ORP electrodes, including more than 300 models, incorporating over 20 years of electrode manufacturing experience.

The most advanced feature of this series is the electrode shape with a flat tip, virtually eliminating deposits that can foul the electrode, significantly reducing necessary maintenance. This characteristic makes flat tip electrodes ideal for continuous in-line monitoring and for solutions containing aggressive chemicals.

The PVDF body offers a higher level of mechanical and temperature resistance. Moreover, the PVDF material is non-toxic and compatible with food applications.

Each pH and ORP electrode is provided with an internal matching pin that can avoid typical problems caused by grounding loop current, such as:

- progressive damage of the electrode
- fluctuating measurements
- poor process regulation

Glass Type	Application	pH Range	Temperature Range
LT	low temperature	0 to 12	-10 to 80°C
HT	high temperature	0 to 14	0 to 100°C
HF	acid samples with F- (*)	0 to 10	-5 to 60°C

(\*) F- max 2 g/L, temperature max 60°C, pH > 2

# 15 Flat Tip Industrial pH Electrodes

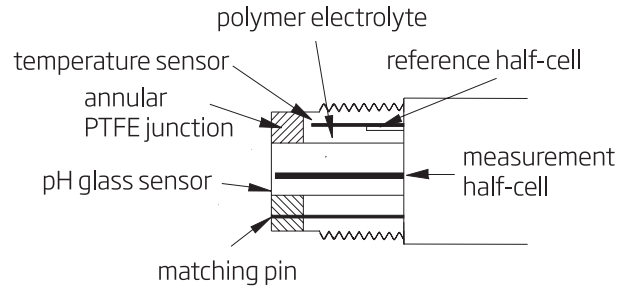
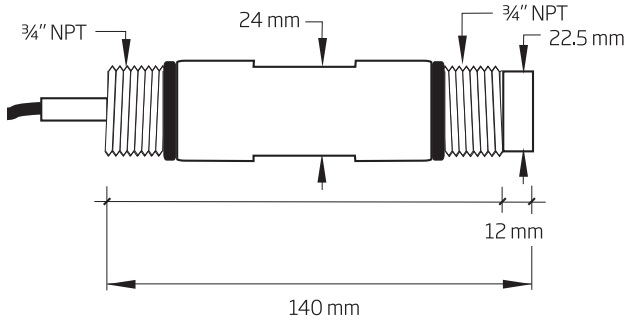

### Flat Tip pH Electrodes: Ordering Information

Choose your configuration:

w =	06	PTFE junction
	16	ceramic junction
	26	open junction*
x =	1	LT (Low Temperature) glass sensor
	2	GP (General Purpose) glass sensor
	3	HT (High Temperature) glass sensor; titanium matching pin
	4	HF (Fluoride resistant) glass sensor
y =	0	BNC connector
	1	direct wire connection
	2	BNC connector + Pt100
	3	direct wire connection + Pt100
	4	BNC connector + Pt1000
	5	direct wire connection + Pt1000
	6	amplified electrode with BNC connector
z =	05, 10, 15	Cable length (meters); for non-amplified electrodes
	15, 25, 50, 75	Cable length (meters); for amplified electrodes

**HI10** w - x y z

\* Open junction is available only with GP glass sensor.

Note: The internal amplifier can be powered directly from select Hanna process controllers or a power source that supplies the appropriate voltage.

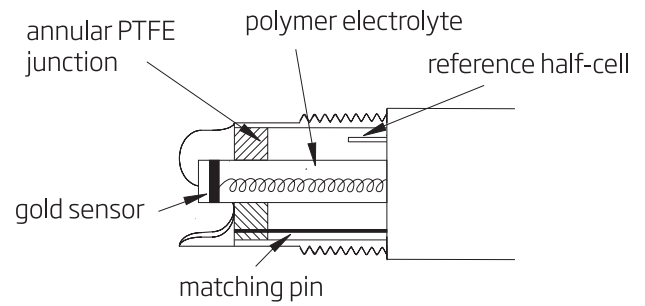
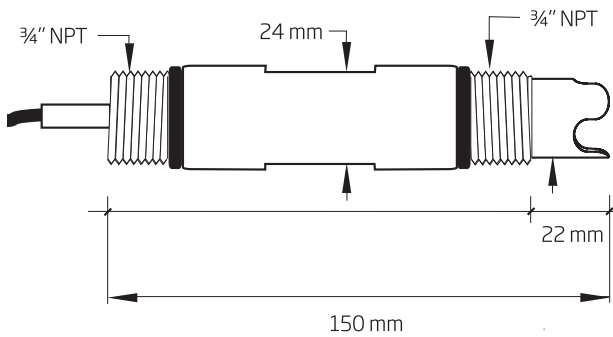
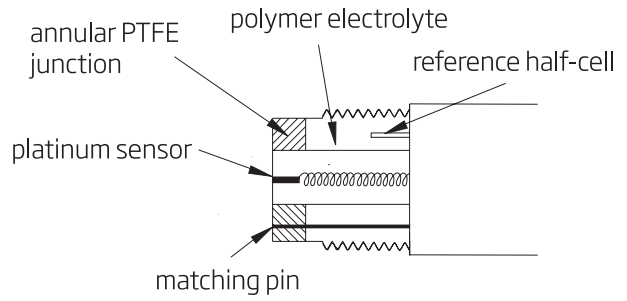
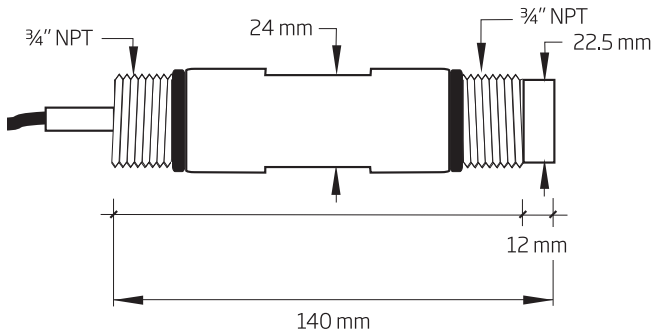

### Flat Tip ORP Electrodes: Ordering Information

Choose your configuration:

w =	04	PTFE junction
	14	ceramic junction
	24	open junction
x =	1	platinum sensor
	2	gold sensor
y =	0	BNC connector
	6	amplified electrode with BNC connector
z =	05, 10, 15	Cable length (meters); for non-amplified electrodes
	15, 25, 50, 75	Cable length (meters); for amplified electrodes

**HI20**  -

Note: The internal amplifier can be powered directly from select Hanna process controllers or a power source that supplies the appropriate voltage.

# AmpHel Flat Tip Industrial Electrodes

- AmpHel amplified
- Matching pin
- Flat tip
- PVDF body



## AmpHel Flat-tip pH Electrodes

### General Purpose pH Electrodes

Code	Range	Body	Junction	Electrolyte	Glass Type	Temperature	ATC	Max Pressure	Connector	Cable
HI6100405	0-13	PVDF	double, PTFE	polymer	GP	-5 to 80 °C	-	6 bar (87 psi)	BNC	5 m
HI6100410	0-13	PVDF	double, PTFE	polymer	GP	-5 to 80 °C	-	6 bar (87 psi)	BNC	10 m
HI6101405	0-13	PVDF	double, PTFE	polymer	GP	-5 to 80 °C	Pt100	6 bar (87 psi)	BNC + lead	5 m
HI6101415	0-13	PVDF	double, PTFE	polymer	GP	-5 to 80 °C	Pt100	6 bar (87 psi)	BNC + lead	15 m

### Low Temperature pH Electrodes

Code	Range	Body	Junction	Electrolyte	Glass Type	Temperature	ATC	Max Pressure	Connector	Cable
HI6101605	0-12	PVDF	double, PTFE	polymer	LT	-10 to 80 °C	Pt100	6 bar (87 psi)	BNC + lead	5 m

### High Temperature pH Electrodes

Code	Range	Body	Junction	Electrolyte	Glass Type	Temperature	ATC	Max Pressure	Connector	Cable
HI6100805	0-14	PVDF	double, PTFE	polymer	HT	0 to 100 °C	-	6 bar (87 psi)	BNC	5 m
HI6101805	0-14	PVDF	double, PTFE	polymer	HT	0 to 100 °C	Pt100	6 bar (87 psi)	BNC + lead	5 m

### pH Electrodes for Acid Samples with Fluoride Ions (F<sup>-</sup> max 2 g/L, Temperature Max 60 °C, pH >2)

Code	Range	Body	Junction	Electrolyte	Glass Type	Temperature	ATC	Max Pressure	Connector	Cable
HI6100205	0-10	PVDF	double, PTFE	polymer	HF	-5 to 60 °C	-	6 bar (87 psi)	BNC	5 m
HI6101205	0-10	PVDF	double, PTFE	polymer	HF	-5 to 60 °C	Pt100	6 bar (87 psi)	BNC + lead	5 m

## AmpHel Flat-tip ORP Electrodes

### Platinum Type ORP Sensors

Code	Range	Body	Junction	Electrolyte	Temperature	ATC	Max Pressure	Connector	Cable
HI6200405	±2000 mV	PVDF	double, PTFE	polymer	-5 to 100 °C	-	6 bar (87 psi)	BNC	5 m

### Gold Type ORP Sensors

Code	Range	Body	Junction	Electrolyte	Temperature	ATC	Max Pressure	Connector	Cable
HI6200505	±2000 mV	PVDF	double, PTFE	polymer	-5 to 100 °C	-	6 bar (87 psi)	BNC	5 m



# Flat Tip Industrial Electrodes Electrical Connections and Installation

## Electrical Connections

### pH & ORP electrodes with BNC connector

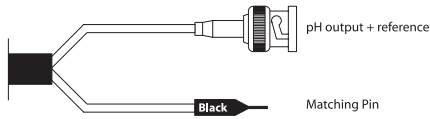

### pH & ORP electrodes with direct wire connection

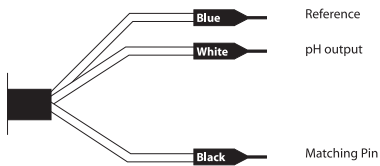

### pH electrodes with BNC connector & Pt100 or Pt1000 temperature sensor

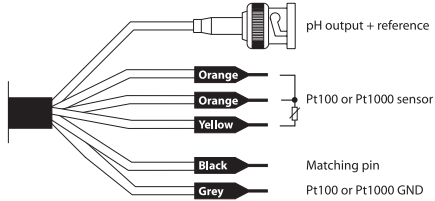

### pH electrodes with BNC connector & Pt100 or Pt1000 temperature sensor, amplified

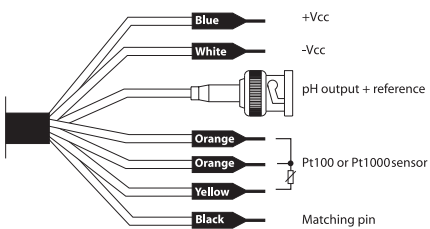

### pH & ORP electrodes with BNC connector, amplified

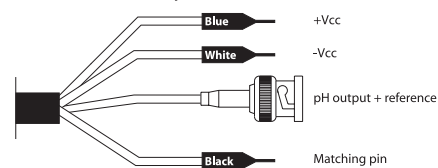

### pH electrodes with direct wire connection & Pt100 or Pt1000 temperature sensor

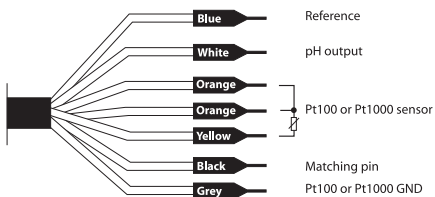

## Installation

These electrodes have been designed with 3/4" external thread on both ends for easy installation.

Hanna also provides a series of probe holders for in-line, tank or by-pass installations for these electrodes, as shown below.

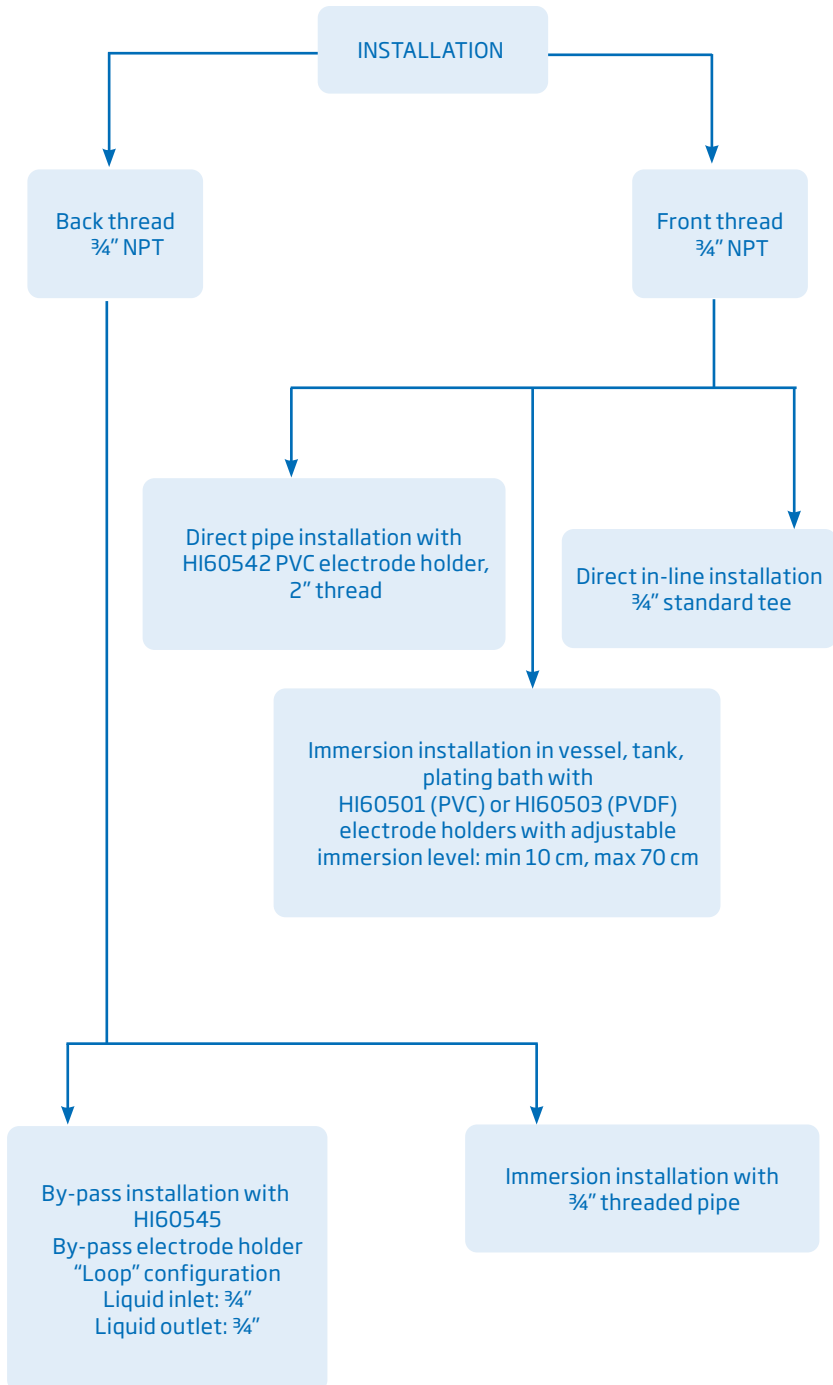

- Strong signal up to 75 meters (246')
- Low noise coaxial cables are no longer required
- Measurements in unclean samples and high humidity conditions
- Models with external replaceable battery, for longer electrode life
- Glass sensor for specific applications

Due to the high resistance of the glass membrane, conventional electrodes require a high impedance measurement system. Inadequate insulation of the connectors and cables results in erroneous readings due to leakage or noise. For conventional electrodes, the lead is therefore limited to typically less than 15-20 meters. Hanna AmpHel electrodes incorporate a miniaturized amplifier which resolves most of the problems associated with high impedance signals. The amplifier circuitry is located right on top of the electrode and is completely sealed. As a result, a strong, low impedance signal is emitted and ordinary connectors with long unshielded cables can be used. This breakthrough technology provides a stable signal for industrial monitoring as well as a major saving in low noise coaxial cable costs. In some cases, the need for a transmitter is also eliminated, resulting in further cost reductions.

For those applications that have been proven particularly hostile to electrodes, Hanna has developed four types of specialized glass. First is an extremely durable sensor glass for general purpose and industrial use. This glass can withstand the stress of daily use. The remaining types of electrode glass allow continuous monitoring in highly acidic solutions containing fluoride ions, as well as high or low temperature process streams, without significantly reducing the life of the electrode.

The electrode body material is glass or PEI, while the junction is cloth or PTFE.

### Hanna Glass Sensors for Process Electrodes

Glass Membrane	Application
GP	General Purpose
HT	High Temperature
LT	Low Temperature
HF	Samples with Fluoride

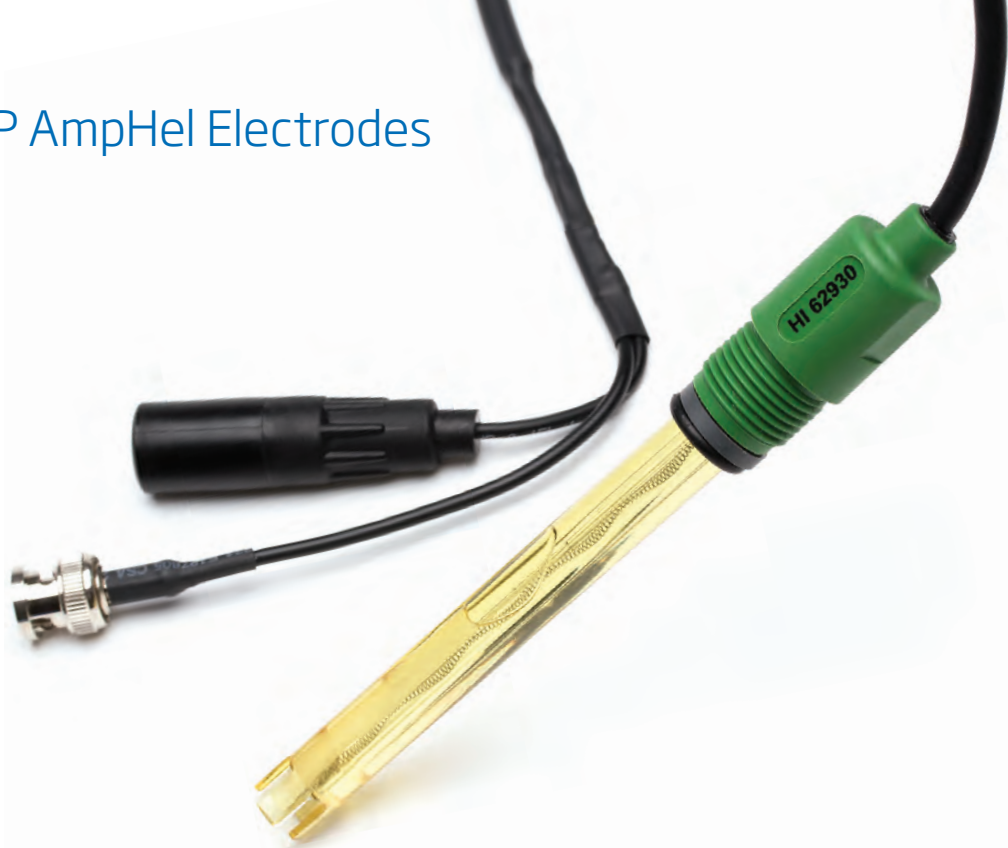

- **Extend Electrode Life**
  - With the AmpHel replaceable battery model, it is no longer necessary to throw away an electrode when the battery is exhausted.

### AmpHel Battery

Code	Description
HI740031	Battery, spare for AmpHel electrodes

### Easy Installation

Models with glass body and PTFE junctions are recommended for in-line installations.

Models with an PEI body and cloth junction are suitable for tank monitoring or for use with portable meters, where the electrode can be easily accessed for maintenance.

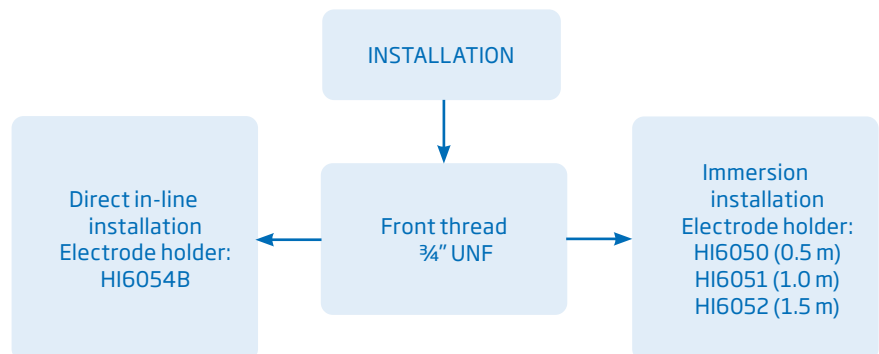

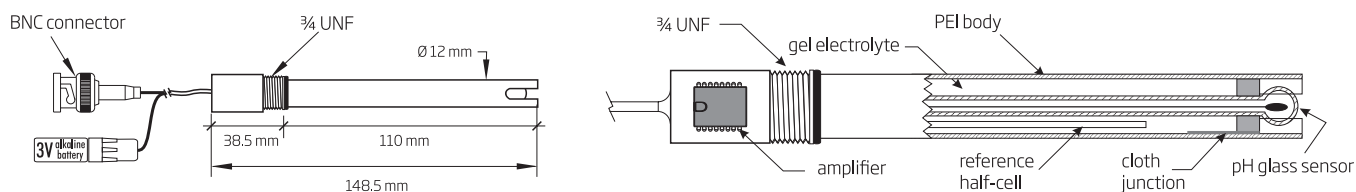

## Amphel pH Electrodes with Replaceable Battery - General Purpose pH Electrodes

Code	Body	Junction	Electrolyte	Glass Type	Temperature	Max Pressure	Connector	Cable
HI6291005	PEI	cloth	gel	GP	-5 to 70 °C	3 bar	BNC	5 m

## Amphel pH Electrodes with Replaceable Battery - High Temperature pH Electrodes

Code	Body	Junction	Electrolyte	Glass Type	Temperature	Max Pressure	Connector	Cable
HI8299505	glass	PTFE	polymer	HT	0 to 100 °C	3 bar	BNC	5 m



## Amphel pH Electrodes with Internal Battery

Code	Body	Junction	Electrolyte	Glass Type	Temperature	Max Pressure	Connector	Cable
HI2910B	PEI	cloth	gel	GP	-5 to 70 °C	3 bar (43.5 psi)	BNC	1 m
HI2910B/10	PEI	cloth	gel	GP	-5 to 70 °C	3 bar (43.5 psi)	BNC	10 m
HI2910B/15	PEI	cloth	gel	GP	-5 to 70 °C	3 bar (43.5 psi)	BNC	15 m
HI2910B/5	PEI	cloth	gel	GP	-5 to 70 °C	3 bar (43.5 psi)	BNC	5 m
HI2911B/5	PEI	PTFE	polymer	GP	-5 to 80 °C	3 bar (43.5 psi)	BNC	5 m

## Amphel ORP Electrodes with Replaceable Battery

Code	Body	Junction	Electrolyte	PIN Type	Temperature	Max Pressure	Connector	Cable
HI6293005	PEI	cloth	gel	platinum	-5 to 80 °C	3 bar (43.5 psi)	BNC	5 m
HI6493005	PEI	cloth	gel	gold	-5 to 80 °C	3 bar (43.5 psi)	BNC	5 m

## Amphel ORP Electrodes with Internal Battery

Code	Body	Junction	Electrolyte	PIN Type	Temperature	Max Pressure	Connector	Cable
HI2930B/5	PEI	cloth	gel	platinum	-5 to 80 °C	3 bar (43.5 psi)	BNC	5 m
HI2931B/5	PEI	PTFE	gel	platinum	-5 to 80 °C	3 bar (43.5 psi)	BNC	5 m

# pH and ORP Electrodes for Continuous Flow-thru Monitoring

*Specifically Built for Industrial Applications*

- ½" NPT external thread for in-line installation
- pH electrode with exclusive PTFE non-clogging membrane
- Double-junction technology
- PVDF body
- Models with built-in matching pin and amplifier

In order to reduce normal contamination coming from industrial use, these electrodes combine a polymer reference and double-junction technology. With this technology, no refilling is required and the electrode can be used in samples such as organic compounds, proteins and heavy metals. In addition, the pH electrodes use a unique annular PTFE junction that minimizes clogging.

These industrial probes have a glass body electrode for use in aggressive chemicals and are easy to clean. A PEI protective sleeve gives the electrodes resistance against mechanical stress. Operating limits are -5 to 80°C (23 to 176°F) and pressure up to 6 bar (87 psi).

Both pH and ORP models are available, many of which include a built-in matching pin. Some models also feature a built-in amplifier, which allows for measurements to be taken far from the location of the instrument without requiring a transmitter.

HI1000 and HI2000 series incorporate a BNC connector that enables connection to any pH/ORP meter quickly and easily. Models with 3 or 5 meters (9.8 or 16 feet) cable are available.

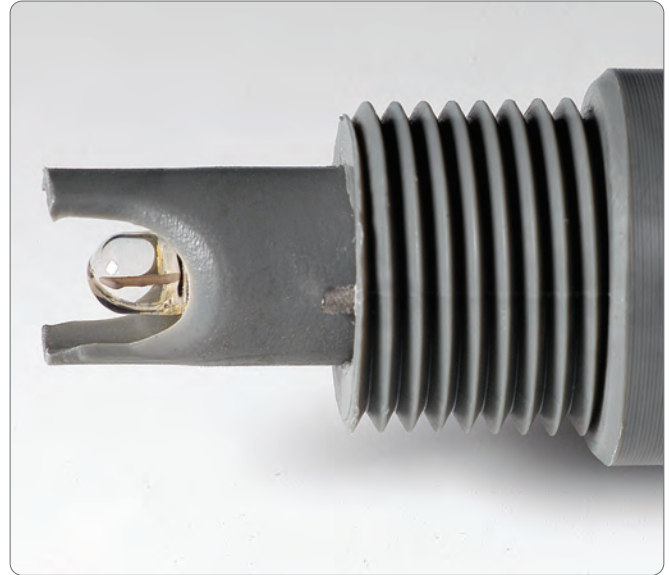

Matching pin with differential input for grounding

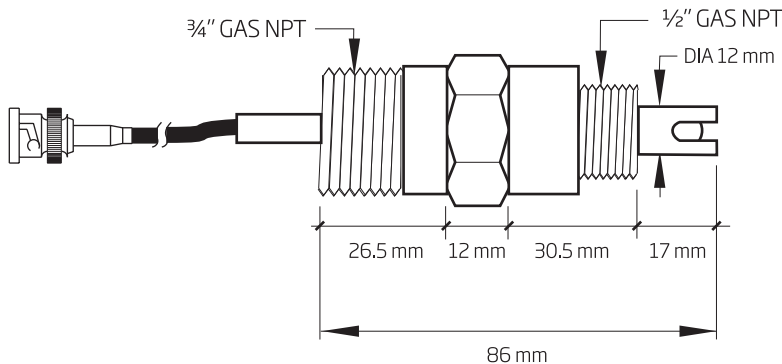

HI1000 and HI2000 series

## HI1001 and HI1005 (pH Electrodes) and HI2001 (ORP Electrode with Pt sensor)

Code	Junction	Electrolyte	Temperature	Max Pressure	Connector	Cable
HI1001	double, PTFE	polymer	-5 to 80°C - HT	6 bar (87 psi)	BNC	3 m
HI1005	double, PTFE	polymer	-5 to 80°C	6 bar (87 psi)	DIN	0.5 m
HI2001	double, PTFE	polymer	-5 to 80°C	6 bar (87 psi)	BNC	3 m

# pH and ORP Electrodes for Continuous Flow-thru Monitoring

Specifically Built for Industrial Applications

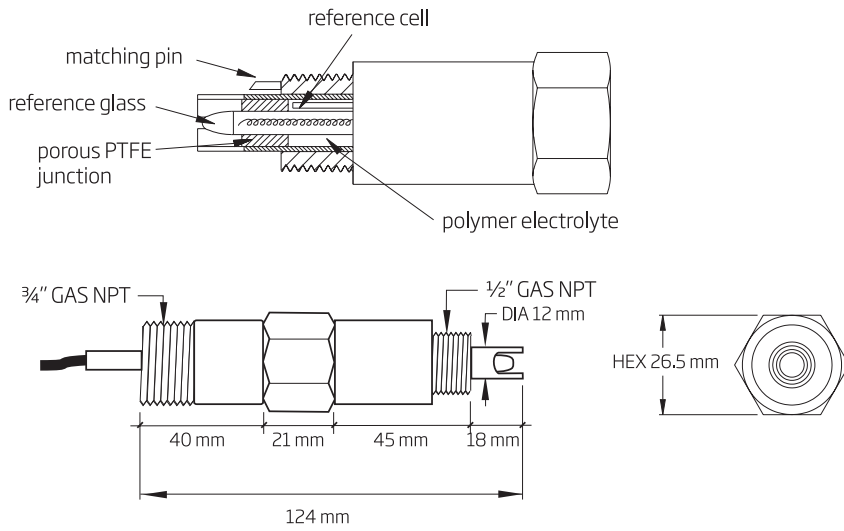

## HI1000 Series: pH Electrodes

Code	Junction	Electrolyte	Matching Pin	Amplifier	Temperature	Max Pressure	Connector	Cable
HI1002/3	double, PTFE	polymer	-	-	-5 to 80°C - HT	6 bar (87 psi)	BNC	3 m
HI1002/5	double, PTFE	polymer	-	-	-5 to 80°C - HT	6 bar (87 psi)	BNC	5 m
HI1003/3	double, PTFE	polymer	yes	-	-5 to 80°C - HT	6 bar (87 psi)	BNC	3 m
HI1003/5	double, PTFE	polymer	yes	-	-5 to 80°C - HT	6 bar (87 psi)	BNC	5 m

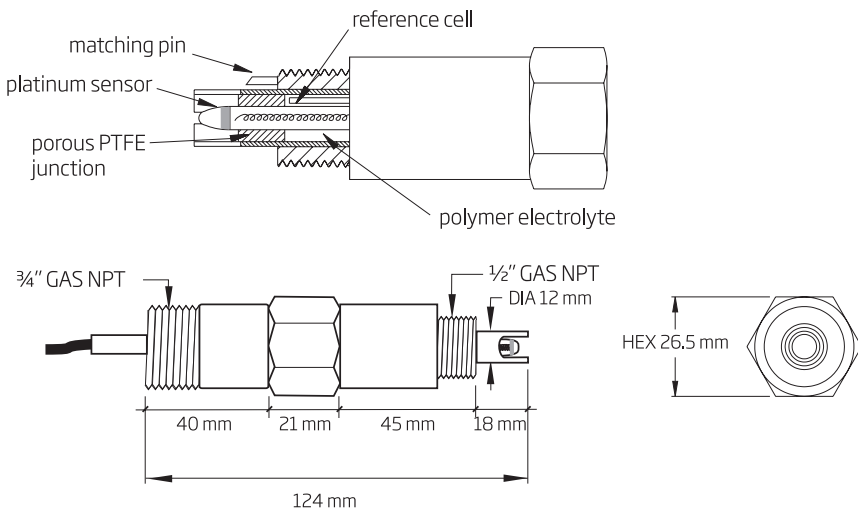

## HI2000 Series: ORP Electrodes with Platinum Sensor

Code	Junction	Electrolyte	Matching Pin	Amplifier	Temperature	Max Pressure	Connector	Cable
HI2002/3	double, PTFE	polymer	-	-	-5 to 80°C	6 bar (87 psi)	BNC	3 m
HI2002/5	double, PTFE	polymer	-	-	-5 to 80°C	6 bar (87 psi)	BNC	5 m
HI2003/3	double, PTFE	polymer	yes	-	-5 to 80°C	6 bar (87 psi)	BNC	3 m
HI2003/5	double, PTFE	polymer	yes	-	-5 to 80°C	6 bar (87 psi)	BNC	5 m

# pH and ORP Electrodes for Continuous Flow-thru Monitoring

Specifically Built for Industrial Applications

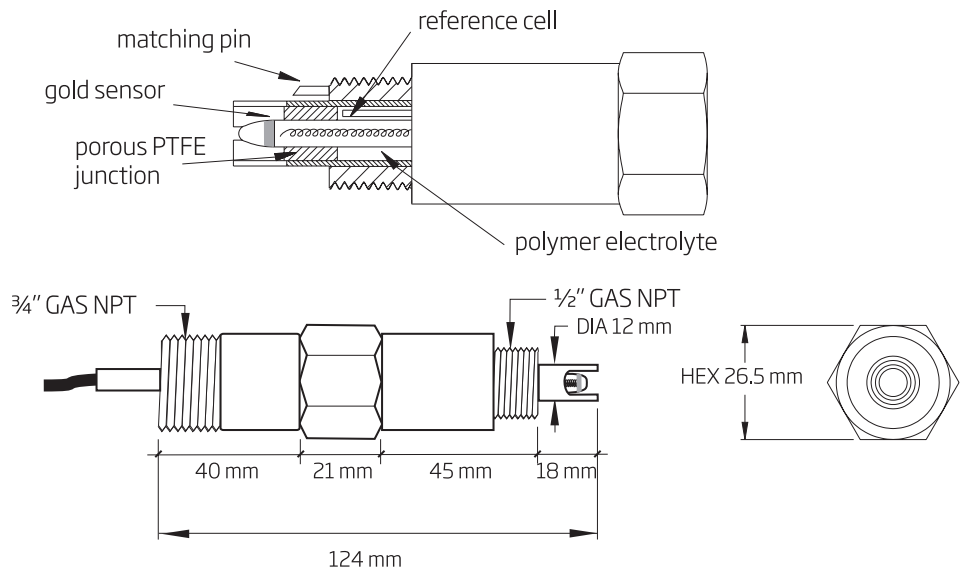

## HI2000 Series: ORP Electrodes with Gold Sensor

Code	Junction	Electrolyte	Matching Pin	Amplifier	Temperature	Max Pressure	Connector	Cable
HI2008	double, PTFE	polymer	yes	yes	-5 to 80°C	6 bar (87 psi)	DIN	0.5 m

### Installation

These sensors have a hex-shaped body for easy installation, requiring no special tools. Continuous in-line mounting is possible due to the 1/2" external thread. No special holders are required: HI1000 and HI2000 series can be used with any standard 1/2" pipe tee available on the market. On the opposite end, these probes are provided with a 3/4" thread so that they can be attached to a pipe for dip applications.

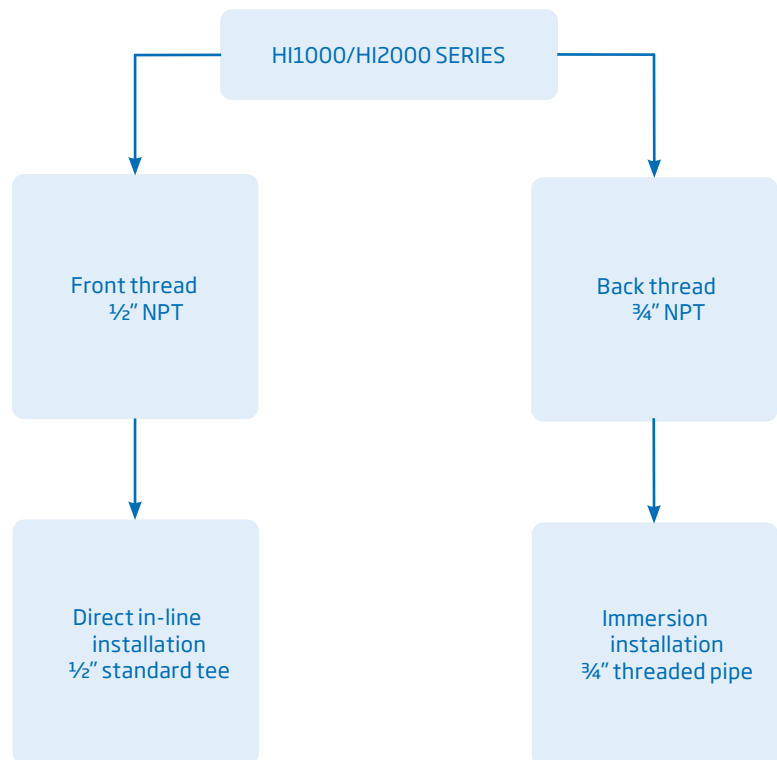

with Quick and Easy BNC Connection

- BNC connector
- Submersion and in-line installation capability
- PEI and glass body

Hanna offers a wide range of combination pH and ORP electrodes specifically designed for the needs of industrial users.

In order to reduce contamination problems, all electrodes are gel or polymer filled and feature double-junction technology.

The BNC connector allows quick and easy connection to any pH/ORP meter or transmitter. In addition to this type of connection, select models offer a 3/4" UNF thread for secure in-line installation.

PEI and glass body electrodes are available. PEI bodied electrodes are rugged and suitable for applications in which the capability to resist stress is needed. Glass body electrodes are easier to clean and recommended for use in aggressive chemicals.

All Hanna pH and ORP electrodes can be mounted with the Hanna in-line and submersion assemblies.

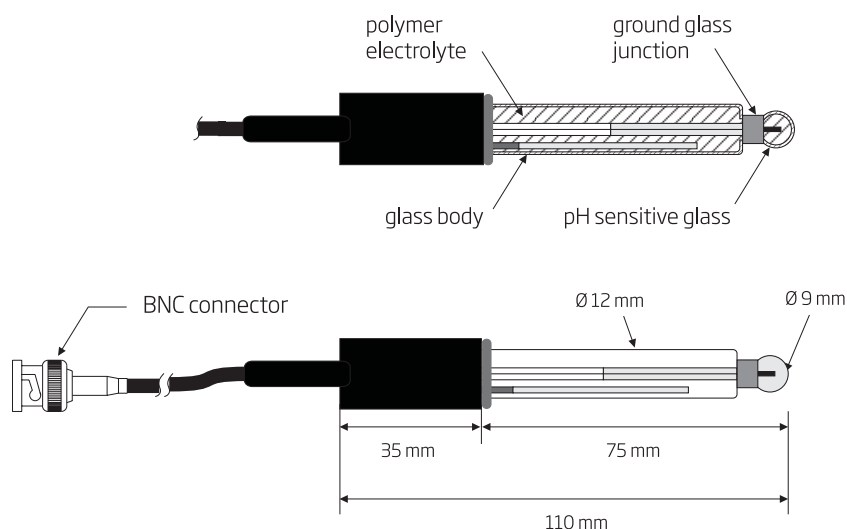

## Combination Glass-body pH Electrode

Code	Junction	Electrolyte	Temperature	Max Pressure	Connector	Cable
HI1090B/5	double, ground glass	polymer	-5 to 95°C (23-203°F) - HT	3 bar (43.5 psi)	BNC	5 m

# Easy pH and ORP Electrodes

with Quick and Easy BNC Connection

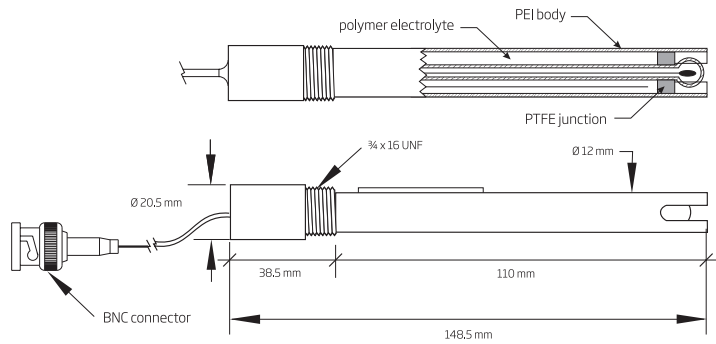

## Combination PEI-body pH Electrode

Code	Junction	Electrolyte	Temperature	Max Pressure	Connector	Cable
HI1210B/5	double, PTFE	polymer	-5 to 80°C - GP	3 bar (43.5 psi)	BNC	5 m

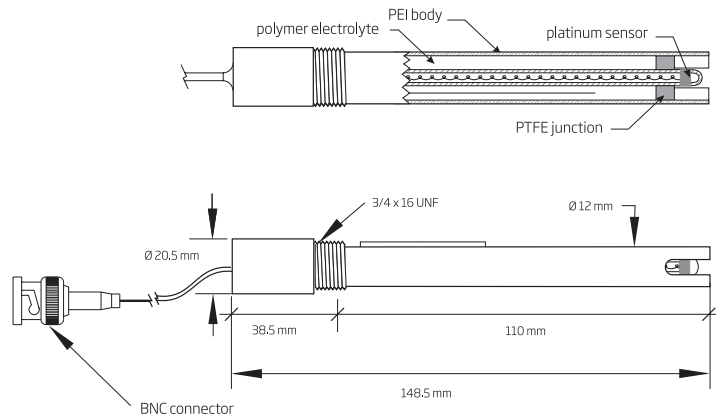

## Combination PEI-body ORP Electrode with Platinum Sensor

Code	Junction	Electrolyte	Temperature	Max Pressure	Connector	Cable
HI3210B/5	double, PTFE	polymer	-5 to 80°C	3 bar (43.5 psi)	BNC	5 m

## Installation

These electrodes feature flexible installation, with different mounting configurations available

Models with a glass body and no external thread can be installed on tanks using the HI6050 electrode holder with sealing O-ring.

Models with a PEI body and 3/4" UNF thread or glass body and no thread can be easily installed directly in-line, using a T-shaped electrode holder, such as HI6054B.

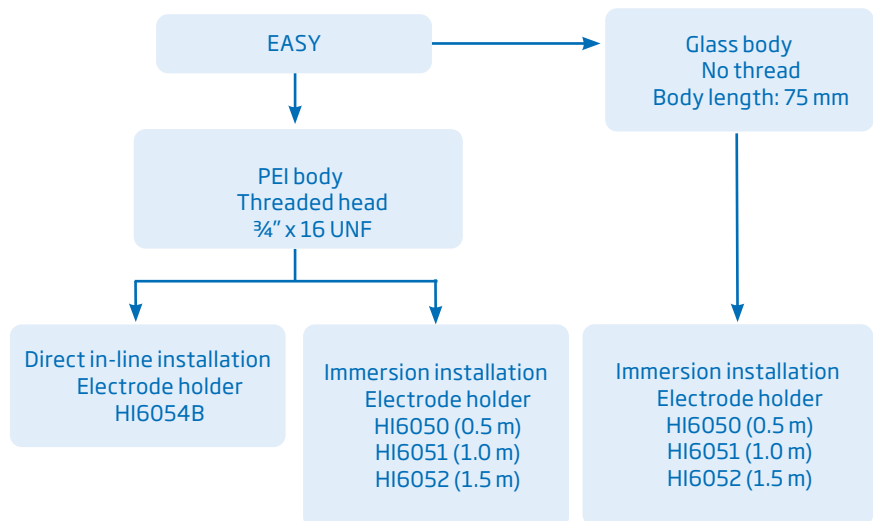



# pH and ORP Electrodes

with T-type Connection

- Screw cap connector and PG 13.5 thread
- Easy operation
- Double-junction technology

Electrodes featuring a T-connector have been designed by Hanna to take advantage of both PG 13.5 thread and screw cap. The PG 13.5 thread ensures proper in-line installation; furthermore, the user can quickly and easily perform all servicing and maintenance procedures. The screw cap allows for maximum versatility making it possible to connect a cable of different lengths. Easily detachable cables make electrode replacement simple.

HI1190T has an open junction using ground glass. This probe is ideal for samples with a high solids content.

HI1192T is made for low conductivity water with an extra reserve of KCl.

Many models are available to choose from, all of which feature a double junction of gel polymer filling to ensure long electrode life and reliability in harsh environments. In addition, users can select from ground-glass or PTFE junction technology to meet the needs of their specific application.

Hanna electrode holders and assemblies are featured at the end of this section for in-line and submersion applications. These optional accessories can be dismantled and reassembled easily without requiring any special tools.



HI1090T

HI1190T

HI1191T

HI1192T

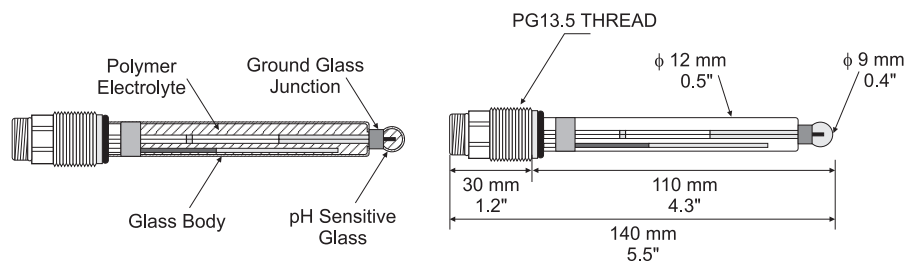

## Combination Glass-body pH Electrode

Code	Glass	Junction	Electrolyte	Temperature	Max Pressure	Connector	Application
HI1090T		double, PTFE	polymer	-5 to 95°C (23 to 203°F) - LT	3 bar (43.5 psi)	T-type	
HI1190T	hardened	double, ground glass	polymer	-15 to 80°C (5 to 176°F) - LT	6 bar (87 psi)	T-type	high solids
HI1191T	hardened	double, PTFE	polymer	-15 to 80°C (5 to 176°F) - LT	8 bar (116 psi)	T-type	general
HI1192T	hardened	double, PTFE	polymer	-15 to 80°C (5 to 176°F) - LT	8 bar (116 psi)	T-type	low conductivity

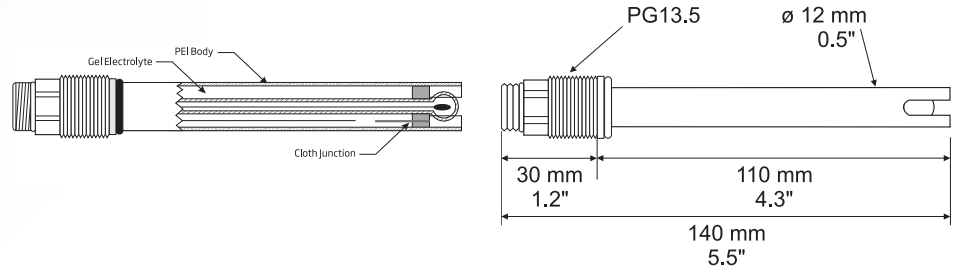

### Combination PEI-body pH Electrode

Code	Junction	Electrolyte	Temperature	Max Pressure	Connector
HI1210T	double, cloth	gel	-5 to 80°C (23 to 176°F) - GP	3 bar (43.5 psi)	T-type
HI1211T	double, PTFE	polymer	-5 to 80°C (23 to 176°F) - HT	3 bar (43.5 psi)	T-type

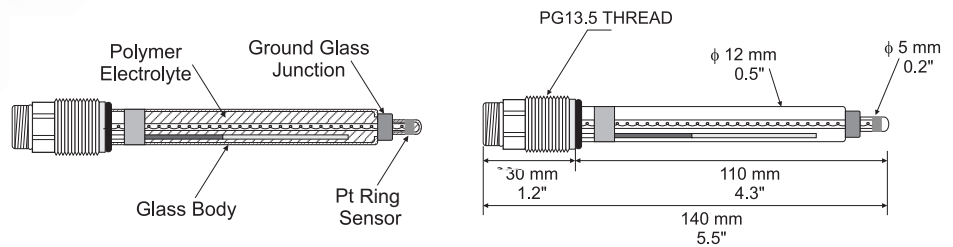

### Combination Glass-body ORP Electrode with Platinum Sensor

Code	Junction	Electrolyte	Temperature	Max Pressure	Connector
HI3090T	double, ground glass	polymer	-5 to 95°C (23 to 203°F)	3 bar (43.5 psi)	T-type
HI3190T	double, PTFE	polymer	-15 to 100°C (5 to 212°F)	6 bar (87 psi)	T-type
HI3211T	double, cloth	polymer	-5 to 80°C (23 to 176°F)	3 bar (43.5 psi)	T-type

### Combination Glass-body ORP Electrode with Gold Sensor

Code	Junction	Electrolyte	Temperature	Max Pressure	Connector
HI4211T	double (AgCl)	gel	0 to 70°C (32 to 158°F)	3 bar (43.5 psi)	T-type



## Industrial Combination pH/ORP/Temperature Probes with Matching Pin

Code	Range	Temperature	Max Pressure	Connector	Cable
HI1036-1802	0-12 pH; ±2000 mV	0 to 70°C	3 bar (43.5 psi)	DIN	2 m
HI1036-1805	0-12 pH; ±2000 mV	0 to 70°C	3 bar (43.5 psi)	DIN	5 m
HI1036-1810	0-12 pH; ±2000 mV	0 to 70°C	3 bar (43.5 psi)	DIN	10 m
HI1036-1815	0-12 pH; ±2000 mV	0 to 70°C	3 bar (43.5 psi)	DIN	15 m
HI1036-1820	0-12 pH; ±2000 mV	0 to 70°C	3 bar (43.5 psi)	DIN	15 m

## pH and ORP Immersion and In-Line Electrodes



Code	HI101	HI102	HI201
Description	submersible pH electrode	in-line pH electrode	submersible ORP electrode
Reference	double, Ag/AgCl	double, Ag/AgCl	double, Ag/AgCl
Junction / Flow Rate	PTFE	PTFE	PTFE
Electrolyte	polymer	polymer	polymer
Max Pressure	6 bar (25°C)	6 bar (25°C)	6 bar (25°C)
Range	pH: 0 to 13	pH: 0 to 13	pH: 0 to 13
Recommended Operating Temp.	20 to 40°C (68 to 104°F) - GP	20 to 40°C (68 to 104°F) - GP	20 to 40°C (68 to 104°F)
Tip / Shape	flat	flat	flat, platinum
Temperature Sensor	no	no	no
Amplifier	no	no	no
Body Material	PVC	PVC	PVC
Connector	BNC female	BNC female	BNC female
Connection Cable	<b>HI101/3</b> adapter with 3 m (9.9') cable <b>HI101/5</b> adapter with 5 m (16') cable	<b>HI101/3</b> adapter with 3 m (9.9') cable <b>HI101/5</b> adapter with 5 m (16') cable	<b>HI101/3</b> adapter with 3 m (9.9') cable <b>HI101/5</b> adapter with 5 m (16') cable
Recommended Use	Immersion	In-line	Immersion

HI7635

# In-line Conductivity Probes

These conductivity probes combine the proven four-ring potentiometric method of measuring conductivity with platinum sensors. The universally acclaimed four-ring method provides an exceptionally stable measurement over a wider range. These probes do not suffer polarization, nor do they need frequent calibration or cell changes.

The built-in temperature sensor (select models) allows automatically temperature compensated measurements and features easy operation and maintenance.

The majority of probes are provided with a 4 m cable incorporating color coded wires for easy connection to HI8936 transmitters while others provide a DIN connection.

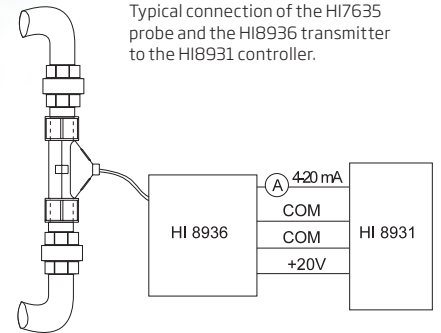
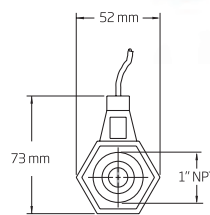
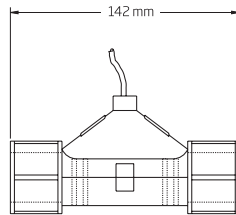

Code	Temperature Compensation	Body	Operating Temperature	Max Pressure (@25°C/77°F)	Cable/ Connection
HI7635	automatic, 0 to 50°C with NTC sensor	polypropylene	0 to 80°C (32 to 176°F)	5 bar	4 m (13.1')/Color coded wires

HI7638 · HI7639

# In-line Conductivity Probes

with Platinum Ring

These conductivity probes combine the proven four-ring potentiometric method of measuring conductivity with platinum sensors. The universally acclaimed four-ring method provides an exceptionally stable measurement over a wider range. These probes do not suffer polarization, nor do they need frequent calibration or cell changes.

HI7638 and HI7639's built-in temperature sensor allows automatically temperature compensated measurements and features easy operation and maintenance.



HI7639

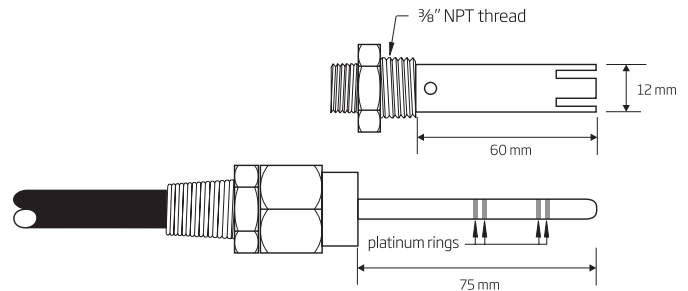

Code	Temperature Compensation	Body	Operating Temperature	Max Pressure (@25°C/77°F)	Cable/Connection
HI7638	automatic, 0 to 50°C with NTC sensor	PEI and Stainless Steel	0 to 120°C (32 to 248°F)	5 bar (72.5 psi)	3 m (9.9')/Color coded wires
HI7638/10	automatic, 0 to 50°C with NTC sensor	PEI and Stainless Steel	0 to 120°C (32 to 248°F)	5 bar (72.5 psi)	10 m (32.8')/Color coded wires
HI7638/20	automatic, 0 to 50°C with NTC sensor	PEI and Stainless Steel	0 to 120°C (32 to 248°F)	5 bar (72.5 psi)	20 m (65.6')/Color coded wires
HI7639	automatic, 0 to 50°C with Pt100 sensor	PEI and Stainless Steel	0 to 120°C (32 to 248°F)	5 bar (72.5 psi)	3 m (9.9')/Color coded wires

HI3001 · HI3001D · HI3011

## Flow-thru Conductivity Probes

These probes measure conductivity with platinum sensors. They come with standard  $\frac{1}{2}$ " external thread on the front for flow-thru mounting and  $\frac{3}{4}$ " threads on the back for submersion or pipe mounting.

These probes feature 3 m (9.9') of cable and the protective cover is made of PEI and can be removed for quick maintenance. These probes can withstand temperatures up to 80°C (176°F) and 6 bars (87 psi) of pressure.

In addition, HI3001 houses an NTC sensor for Automatic Temperature Compensation.

*Model HI3001D with DIN connector is to be used with the HI99xx series of wall-mounted controllers.*

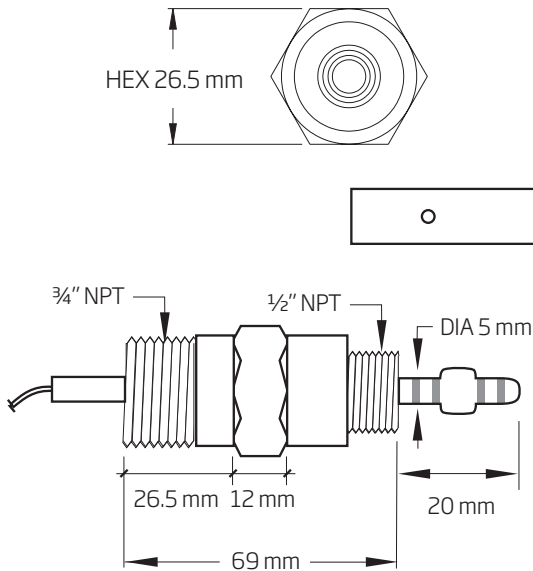

HI3001



Code	Temperature Compensation	Body	Operating Temperature	Max Pressure (@25°C/77°F)	Connector	Cable
Four-Ring Probes						
HI3001	automatic, 0 to 60°C with NTC sensor	PEI and PVDF	0 to 80°C (32 to 176°F)	6 bar (87 psi)	-	3 m (9.9')
HI3001D	automatic, 0 to 60°C with NTC sensor	PEI and PVDF	0 to 80°C (32 to 176°F)	6 bar (87 psi)	DIN	3 m (9.9')
HI3001D/5	automatic, 0 to 60°C with NTC sensor	PEI and PVDF	0 to 80°C (32 to 176°F)	6 bar (87 psi)	DIN	5 m (16.4')
HI3001D/10	automatic, 0 to 60°C with NTC sensor	PEI and PVDF	0 to 80°C (32 to 176°F)	6 bar (87 psi)	DIN	10 m (32.8')
HI3011	-	PEI and PVDF	0 to 80°C (32 to 176°F)	6 bar (87 psi)	-	3 m (9.9')
Two-Ring Probe for <b>HI9914 only</b>						
HI3003/D	automatic, 0 to 60°C with NTC sensor	PEI and PVDF	0 to 80°C (32 to 176°F)	6 bar (87 psi)	DIN	3 m (9.9')

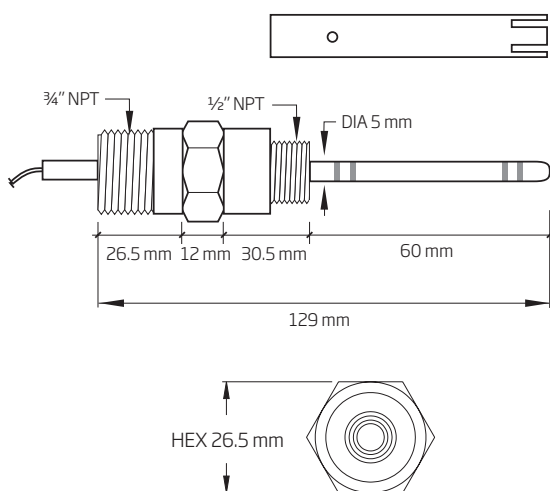

HI3002



HI3002

## Submersion Probes

The HI3002 four-ring probe measure EC with platinum sensors. It comes with standard  $\frac{1}{2}$ " external thread on the front for flow-thru mounting and  $\frac{3}{4}$ " threads on the back for submersion or pipe mounting. Probes incorporate 3 m (9.9') of cable.

The protective probe cover is made of PEI and can be removed for quick maintenance. These probes can withstand temperatures up to 80°C (176°F) and 6 bars (87 psi) of pressure. HI3002 also houses an NTC temperature sensor for automatically temperature compensated measurements.

Code	Temperature Compensation	Body	Operating Temperature	Max Pressure (@25°C/77°F)	Connector	Cable
HI3002	automatic, 0 to 60°C with NTC sensor	PEI and PVDF	0 to 80°C (32 to 176°F)	6 bar (87 psi)	-	3 m (9.9')

HI7610

# Stainless Steel Temperature Probe

- Flow-through and immersion mounting
- High accuracy
- Stainless steel model with ½" GAS NPT external thread
- Glass version with high chemical resistance and PG 13.5 external thread

HI7610 is a temperature probe with a 3-wire Pt100 or Pt1000 sensors. This probe provides accurate and effective temperature compensation. It can be used with a vast array of industrial pH, ORP and conductivity controllers on the market.

HI7610 is constructed of stainless steel and incorporates ½" external threads on both ends to facilitate inline and immersion installations.

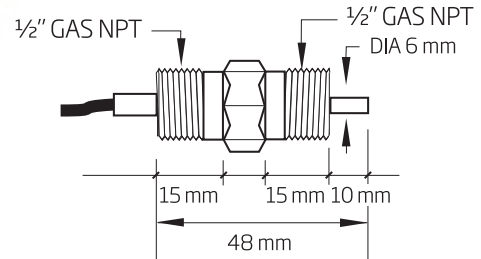

## HI7610 and HI7611 Industrial Temperature Probes

Code	Temperature Sensor	Body	Max Pressure	Cable Length
HI7610	Pt100	stainless steel	8 bar	5 m (16.4')

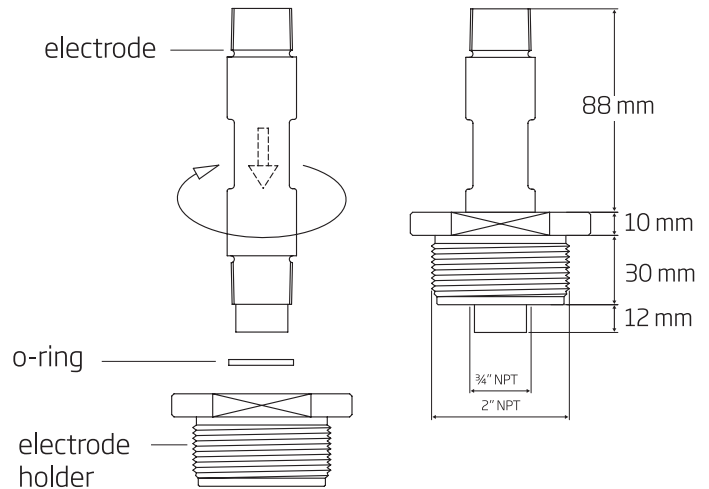

HI60542

# In-line Electrode Holder

*for Direct Pipe Installation*

HI60542 is a two inch NPT in-line PVC electrode holder ideal for direct pipe installation.

HI60542 has been designed specifically to be used with Hanna ¾" NPT process electrodes with built-in temperature sensor and matching pin.

Specifications	HI60542
Electrode Holder Material	PVC
O-ring Material	NBR (Buna N)
Minimum Temperature	-10 °C
Maximum Temperature	+60 °C
Maximum Pressure	8 bar @25°C or 3 bar @50°C

HI60545

# By-pass Loop Electrode Holder

No Downtime

HI60545 is an electrode holder designed for use in a bypass loop configuration.

HI60545 allows easy maintenance and calibration without shutting down the process. The design of HI60545 assures that the glass sensor remains wet even when system is not under pressure.

HI60545 is only for use with Hanna 1006 series probes that have a 3/4" NPT fitting.



Specifications	HI60545
Electrode Holder Material	PVC
O-ring Material	NBR (Buna N)
Minimum Temperature	-10 °C
Maximum Temperature	+60 °C
Maximum Pressure	8 bar @25°C or 3 bar @50°C

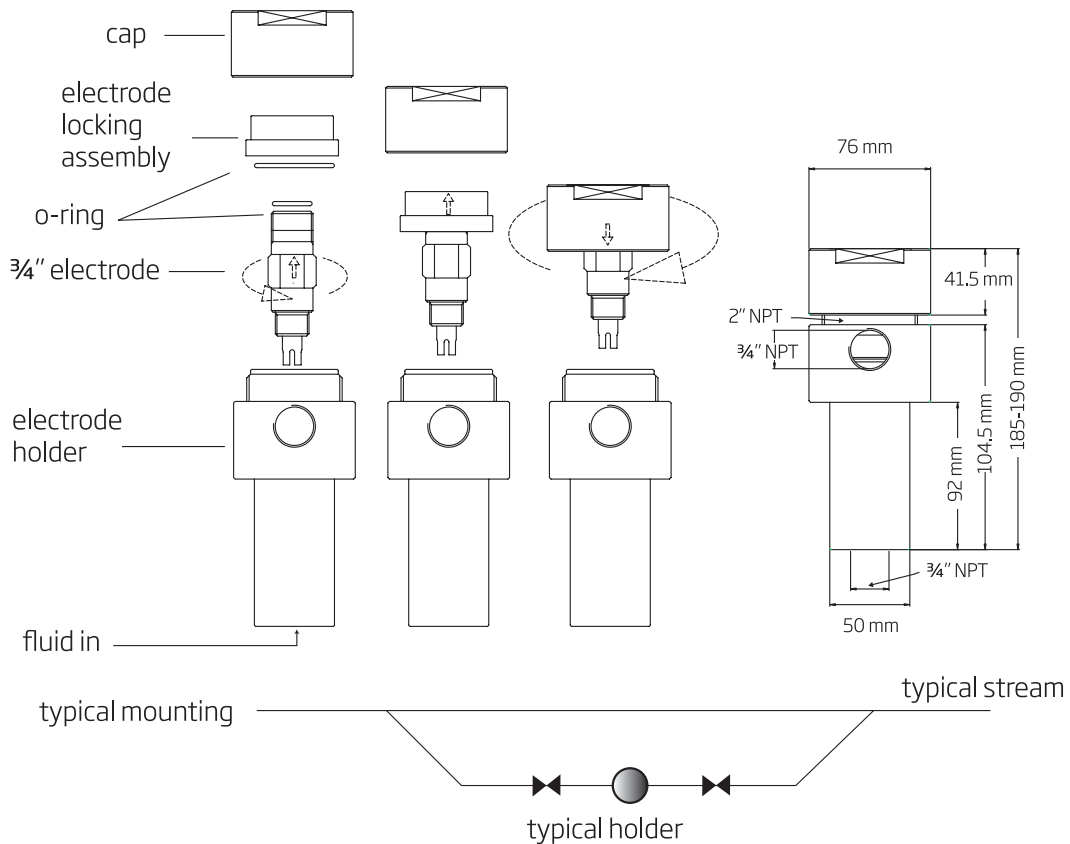

HI6050

# Submersible Electrode Holder

These electrode mounting systems are constructed in rugged PVC and will resist most of the chemicals associated with wastewater treatment.

They are easy to install and require no tools for maintenance, making weekly electrode inspection and meter calibration a quick and easy task.

The mounting flange is a rugged PVC piece that mounts directly to the stainless steel brackets on tanks.

The figure illustrates the suggested bracket dimensions used for mounting. Once mounted to the tank, the electrode holder is a sturdy, protective housing that will extend the life of the electrodes.

The electrode slides into the holder and is hand tightened into place. The cable from the electrode will lead up through the holder and out through the cap on top. The cable is also shielded inside the holder to prevent any damage to the insulation. The protective cap is removable to allow for quick and simple electrode maintenance and replacement.

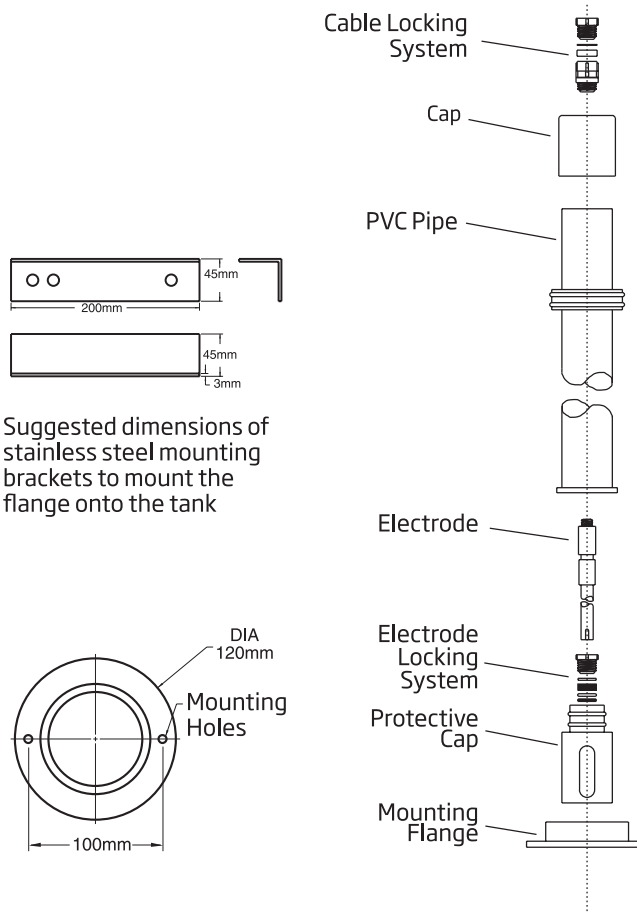
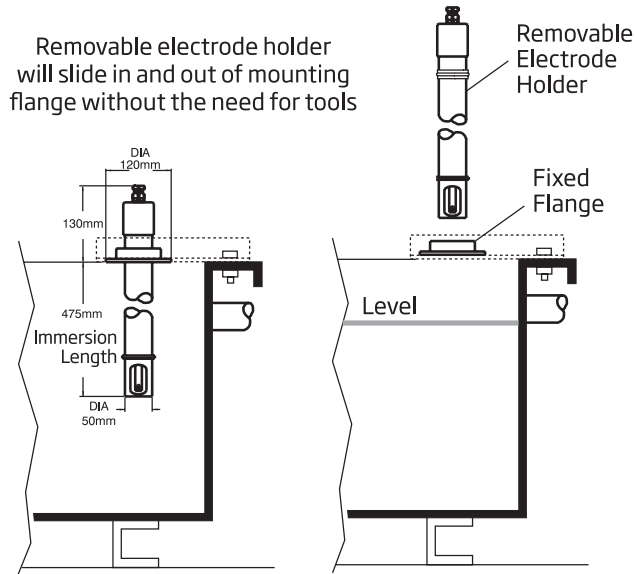

Specifications	Total Length	Weight	Submersion Length
HI6050	605 mm (23.8")	0.8 kg (26 oz.)	475 mm (18.7")
HI6051	1105 mm (43.5")	1.2 kg (44 oz.)	975 mm (38.4")
HI6052	1605 mm (63.2")	2.0 kg (71 oz.)	1500 mm (59.1")



# Electrode Holders

## for In-line Applications

The HI6054 is a rugged, fiber-reinforced polypropylene in-line electrode holder.

Simply install the holder in the line so that liquid will always be present inside of it.

Once installed, the electrode will remain in contact with the fluid at all times, allowing the most accurate readings possible.

The HI6054B and HI6054T are designed specifically to work with Hanna electrodes with external thread of 3/4" x 16 UNF and PG 13.5 respectively.



Actual Installation Examples

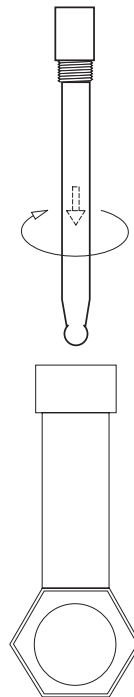
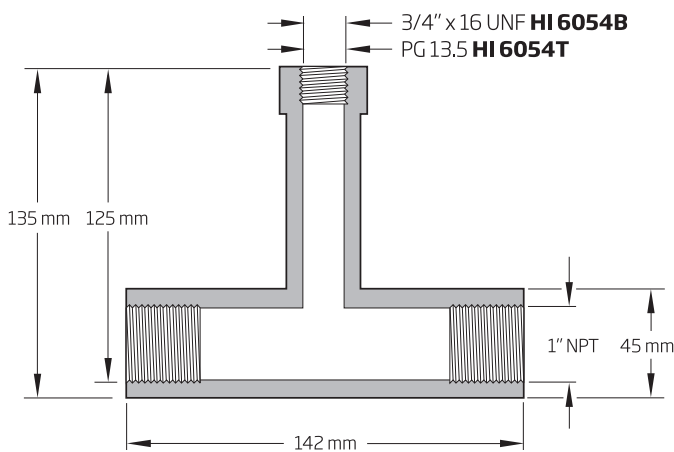

# Immersion Electrode Holders

for Tanks, Vessels, Baths and Open Channels

These electrode holders have an adjustable length and have been designed for immersion applications. Simply set the flange adjuster and the flange (HI605011) to the required length and install.

These holders have been designed specifically to be used with Hanna 1006 series probes that have a 3/4" NPT fitting.

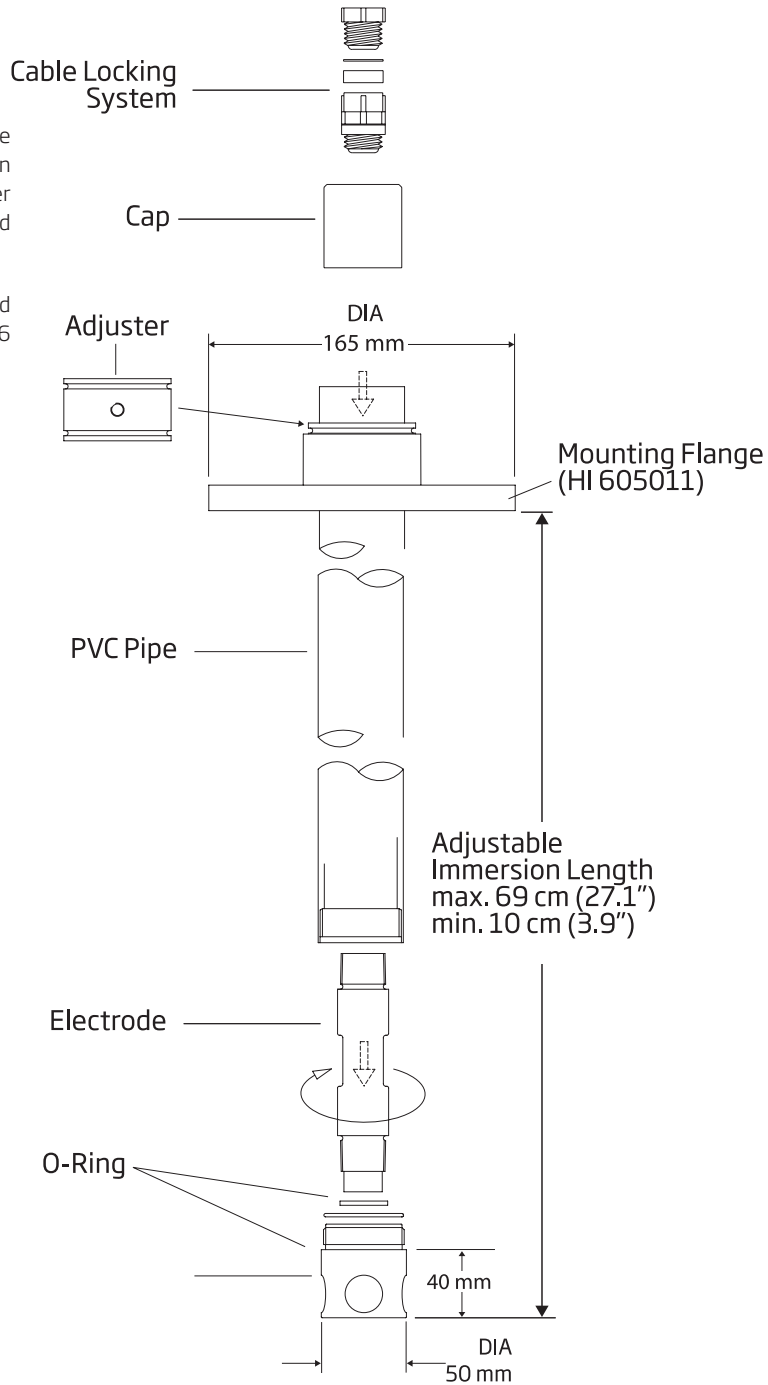

HI60503

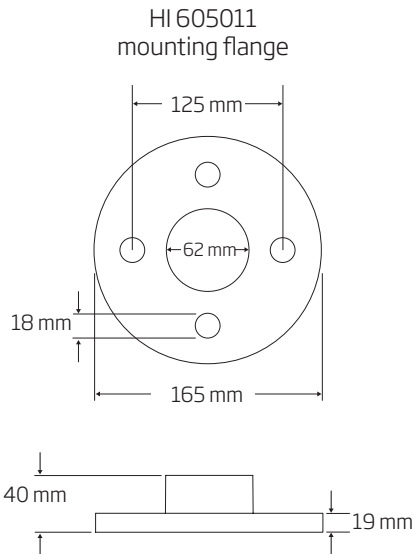

**Specifications**

	HI60501	HI60503
Electrode Holder Material	PVC	PVDF
O-ring Material	NBR (Buna N)	NBR (Buna N)
Minimum Immersion Level	10 cm (3.9")	10 cm (3.9")
Maximum Immersion Level	69 cm (27.1")	69 cm (27.1")
Minimum Temperature	-10°C (14°F)	-15°C (5°F)
Maximum Temperature	+60°C (140°F)	+100°C (212°F)

**Accessories**

HI60501-0 o-ring set



IP67 .....16.2

CE Mark Definition and Compliance..... 16.4

Hanna meter vs. meter without CE.....16.5

ISO Compliance .....16.5

Glossary..... 16.6



### IP67: The Waterproof Advantage

Hanna waterproof meters comply with the IP67 standards that classify them dust-tight and protected against the effect of temporary immersion in water.

This enables the units to operate in the harshest of environments, protected against spills, dust, high humidity and severe weather conditions. This makes them ideal for outdoor measurements and the most severe industrial applications such as mines, food processing, plating, foundries, etc. Hanna waterproof meters are built to last.



## IP Rating

This standard describes a system for classifying the degree of protection provided by the enclosure of electrical/electronic equipment. Developed by the European Committee for Electro-Technical Standardization (CENELEC), these standards are designed to numerically rate an electrical product on the level of protection its enclosure provides. By assigning different number codes, the degree of protection of the product can be quickly and easily identified. In the IP67 code, for example, IP signifies International Protection, the first digit 6 indicates the level of protection from solid objects, and the second digit 7 denotes the level of protection from liquids. See the tables below for the details.

### DEGREE OF PROTECTION (First Number in the Code)

First #	Description
0	No special protection
1	Protected against solid foreign objects of 50 mm diameter and greater, e.g. human hands
2	Protected against solid foreign objects of 12.5 mm diameter and greater, e.g. human hands
3	Protected against solid foreign objects of 2.5 mm diameter and greater, e.g. tools, thick wire
4	Protected against solid foreign objects of 1.0 mm diameter and greater, e.g. wires, screws
5	Ingress of dust is not totally prevented, but dust shall not penetrate in a quantity to interfere with satisfactory operation of the apparatus or to impair safety.
6	No ingress of dust, complete protection

### DEGREE OF PROTECTION FROM LIQUIDS (Second Number in the Code)

Second #	Description
0	Not protected
1	Protected against vertically falling water drops
2	Protected against vertically falling water drops tilted up to 15°
3	Protected against spraying water
4	Protected against splashing water
5	Protected against water jets
6	Protected against powerful water jets
7	Protected against the effects of temporary immersion in water, up to 1 m
8	Protected against the effects of continuous immersion in water, beyond 1 m



All industries make use of electronic instrumentation for their daily operations. The increased use of electronic equipment in many industries means that more instruments are used together and in conjunction with each other, often in a very restricted area.

Proximity of equipment has increased the likelihood of interferences between various instruments, as well as the instruments and the environment surrounding them. Improper operation of the equipment may result from these undesired Electromagnetic Interferences (EMI).

## Electromagnetic Interferences (EMI)

Electromagnetic Interferences are generated by currents which flow into the electronic circuitry of instrumentation. Some electromagnetic interferences originate in nature through atmospheric phenomena, such as lightning and static electricity.

Electromagnetic Compatibility (EMC) Directives define two categories (illustrated below).

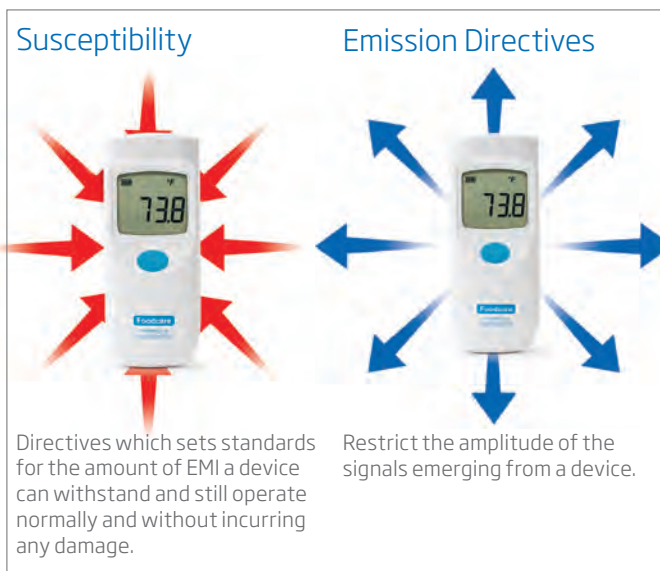

Each category is further sub-divided into:

- Conducted EMI propagated by wires (such as power or connection cables)
- Radiated EMI spread through the air

The effects of these electromagnetic interferences are the main cause for:

- Incorrect equipment operation and therefore, inaccurate measurements
- Damage to the equipment, itself

International Governing bodies have defined the EMI tolerance limits for electronic instruments. The aim is to limit EMI effects and to reach an Electromagnetic Compatibility (EMC) that permits all electronic devices to operate normally, and in proximity with each other, without having an adverse effect on their operation.

## Electromagnetic Compatibility

Electromagnetic Compatibility of an instrument means that electromagnetic interferences will not compromise its functionality, and at the same time, the meter itself will not generate interferences which may affect other equipment. In Europe, the CE mark on a product means compliance with the EMC Directives. The products must meet the directives before they can be legally sold. The CE Directive referring the the "Conducted and Radiated Emissions" is designated as EN 50081-1, while EN 50082-1 defines the prerequisites for "Susceptibility to the Conducted and Radiated EMI".

The "Mission Statement" of Hanna's Research and Development is "a complete dedication in designing electroanalytical instruments to monitor and safeguard the environment, in compliance with the CE Directives". The following provides a short list of the significance of CE Norms and how we comply with them.



- **Radiated Susceptibility**
  - Our instruments are not susceptible to radiation generated by other equipment that in turn can cause improper operation, such as, automatic switching off and/or inaccurate measurements.
- **Radiated Emissions**
  - The Hanna meters do not emit radiation that might cause improper functioning of other equipment in their proximity (such as switching off and/or inaccurate measurements).
- **Susceptibility to Conducted Interferences**
  - This is caused mainly by power leads or signal/control cables connecting different devices, which could result in malfunctioning or permanent damage. Hanna products come with this protection
- **Electrostatic Discharges**
  - Hanna equipment is not susceptible to static electricity from users or objects, whether due to direct contact or proximity. This kind of discharge can cause severe damage to other equipment.
  - Compliance with the CE Directives, ensures reliability and accuracy for products manufactured by Hanna.

To show how susceptible instruments are to outside interference, we had a pH meter without the CE Mark tested against HI 98240 from Hanna (shown below). Both meters had a purported 0.01 pH margin of error.

Both meters were subjected to the effects of an external electromagnetic field, in accordance with the procedures established by the CE Directives. The graphs show the measurements taken at different frequencies.

As you can see from the histograms, at 3 V/meter and 100 MHz frequency, the Hanna meters stayed within the stated tolerance, whereas the non-CE model displayed an erroneous reading of almost 5 pH! The rest of the graph also demonstrates that the readings from the Hanna meter remained practically unvaried throughout the test.

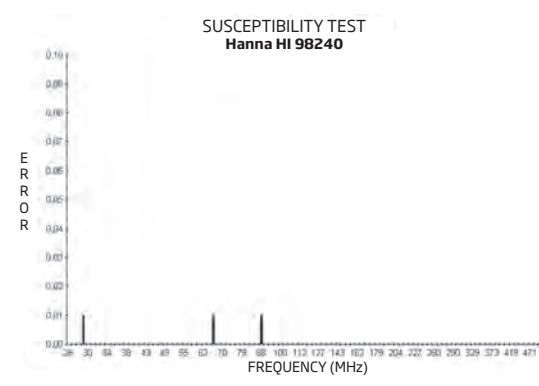
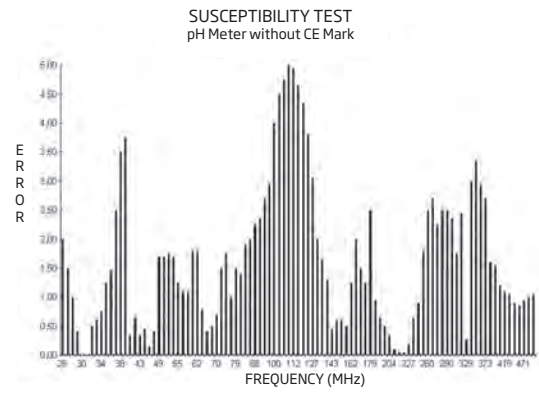

Our commitment to provide quality products for our customers has resulted in instruments manufactured by Hanna, complying with the European Directives

- EN 61000-6-1,
- EN 61000-6-3 and
- EN 61010-1.

## ISO 9001:2015 Compliance

## ISO Standards

ISO 9000 standards were adopted in 1978 by the International Organization of Standards in Geneva, Switzerland, as a uniform standard of excellence for use in the European Economic Community. The standards were an immediate success and have since been adopted in more than 90 countries around the world, including the USA.



In order to obtain an ISO 9001:2015 Certification, each of the following departments need to comply with rigorous ISO standards:

1. Design/Development: Hanna products are designed, developed and engineered under ISO 9001:2015 standards.
2. Production: Every instrument undergoes stringent Quality Control tests at different stages of manufacturing.
3. Quality Assurance: All meters undergo 100% quality control checks prior to shipment.
4. Installation and Servicing: Hanna provides unsurpassed level of customer service, technical support and after sales assistance.

Hanna is an ISO 9001:2015 certified company. Our production system is certified to guarantee our customers a quality product every time.

With Hanna, you receive products manufactured to the most stringent quality standards.

**ABS**

Acrylonitrile butadiene styrene is a common thermoplastic.

**ABS/LAS**

Alkyl benzene sulfonate / Linear alkyl sulfonate (detergents)

**Absorbance**

Absorption of light is a typical phenomenon of interaction between electromagnetic radiation and matter. When a light beam crosses a substance, some of the radiation may be absorbed by atoms, molecules or crystal lattices.

**Accuracy**

The accuracy of an analytical procedure expresses the closeness of agreement between the value which is accepted either as a conventional true value or an accepted reference value and the value found.

**AISI**

The American Iron and Steel Institute.

**Alkalinity**

The quantitative capacity of a water sample to neutralize an acid to a set pH.

**Analytical Procedure**

The analytical procedure refers to the way of performing the analysis. This may include but is not limited to: the sample, the reference standard and the reagents preparations, use of the apparatus, generation of the calibration curve, use of the formula for the calculation, etc.

**Amphel®**

Hanna Amphel electrodes incorporate a miniaturized amplifier which resolves most of the problems associated with high impedance signals. The amplifier circuitry is located right on top of the electrode and is completely sealed. As a result, a strong, low impedance signal is emitted and ordinary connectors with long unshielded cables can be used. This breakthrough technology provides a stable signal for industrial monitoring as well as a major saving in low noise coaxial cable costs. In some cases, the need for a transmitter is also eliminated, resulting in further cost reductions.

**AOAC**

Association of Official Analytical Chemists

**ASBC**

American Society of Brewing Chemists.

**ASTM**

American Society for Testing and Materials.

**ATC**

Automatically Temperature Compensation.

**Auto-feedback**

With a Hanna magnetic stirrer incorporating auto-feedback, any change in viscosity or volume of the solution is automatically compensated for to keep the speed constant.

**Backlight**

A form of illumination used in LCD's; backlights illuminate the LCD from the side or back of the display panel.

**Backpack Lab®**

Backpack Lab from Hanna are portable student laboratories that include a collection of well constructed lessons and activities, testing instruments, and kits for use by educators and students of environmental science.

**°Baumé**

The Baumé scale is used to measure density of various liquids. Notated variously as degrees Baume, degrees Baumé, B°, Be°, Bé, Baume.

**BEPS**

Battery Error Prevention System. Alerts the user in the event that low battery power could adversely affect readings

**BNC Connector**

Bayonet Neill-Concelman connector is a common type of radio-frequency connector used for the coaxial cable which connects various devices; usually is applied for frequencies below 3 GHz.

**BOD**

Biochemical Oxygen Demand (BOD) gives an indication of the biodegradable organic material present in a sample of water. The dissolved oxygen concentration is measured before and after an incubation period of 5 days and the BOD is calculated in mg/L from the difference.

**% Brix**

Degrees Brix is a unit representative of the sugar content of an aqueous solution. One degree Brix corresponds to 1 gram of sucrose in 100 grams of solution (% w/w).

**°C**

Celsius temperature degree; °C = (°F-32) / 5/9

**CAL Check™**

With the Hanna exclusive CAL Check validation function, users are able to verify the performance of the instrument at any time. Taking just a few short steps, the validation procedure is extremely user friendly and ensures that the meter is properly calibrated.



## Calibration

Calibration is the validation of specific measurement techniques and equipment.

The bias is the difference between the mean of the measurements and the reference value. The procedure that establishes and corrects the bias is the calibration.

At the simplest level, calibration is a comparison between measurements – one of known magnitude or correctness made or set with one device and another measurement made in as similar a way as possible with a second device.

Calibration is often regarded as including the process of adjusting the output or indication on a measurement instrument to agree with the value of the applied standard, within a specified accuracy.

## CAL Check™ System

When used in tandem with a CAL Check™ meter, CAL Check™ equipped electrodes permit users to be informed if they have performed a proper calibration. In the event of a dirty or broken electrode or contaminated buffer solution, the system alerts the user to either check the electrode, replace the buffer solution or both. The system also reminds users when the instrument should be recalibrated.

## Calibration Curve

In analytical chemistry, a calibration curve is a general method for determining the concentration of a substance in an unknown sample by comparing the unknown to a set of standard samples of known concentration. A calibration curve is one approach to the problem of instrument calibration; other approaches may mix the standard into the unknown, giving an internal standard.

The calibration curve is a plot of how the instrumental response, the so called analytical signal, changes with the concentration of the analyte (the substance to be measured). The operator prepares a series of standards across a range of concentrations near the expected concentration of analyte in the unknown. The concentrations of the standards must lie within the working range of the technique (instrumentation) they are using. Analyzing each of these standards using the chosen technique will produce a series of measurements. For most analyses, a plot of instrument response vs. Analyte concentration will show a linear relationship. The operator can measure the response of the unknown, and using the calibration curve, they can interpolate to find the concentration of analyte.

## Candela

The candela is the luminous intensity, in a given direction, of a source that emits monochromatic radiation of frequency  $540 \times 10^{12}$  hertz and that has a radiant intensity in that direction of 1/683 watt per steradian.

## CaT

Calcium tartrate

## CE Mark

See page 16.5

## Checker®

Hanna pocket-sized electronic meter.

## Checkfridge™

Hanna temperature monitor with magnetic backing and remote thermistor sensor on a 1 meter cable.

## Checktemp®

Hanna Electronic Digital Thermometer with sharp-tip probe

## CIS

Commonwealth of Independent States

## Cleaning Solution

The solution used for cleaning the glass bulb of the electrode/probe once a day or at least once a week to maintain accuracy and to prevent junction clogging.

## Clip-Lock™

Interrupting an important cycle of analysis due to a malfunctioning burette is a thing of the past. With the Hanna Clip-Lock™ system you can simply substitute the burette and complete all your tests with the same titrant!

The Clip-Lock™ exchangeable burette system prevents cross contamination while reducing loss of time and reagents. Burettes simply slide out for quick exchanges, and detaching the aspiration and dispensing tubes from the titrant bottles is easy.

## COD

Chemical Oxygen Demand is a measure of the oxygen equivalent of the organic matter in the sample that is susceptible to oxidation by a strong oxidizing agent.

## Colorimeter

(see Photometer)

## Colorimetry

Colorimetry is concerned with the determination of the concentration of a substance by measurement of the relative absorption of light with respect to a known concentration of the substance. In visual colorimetry, natural or artificial white light is generally used as a light source, and determinations are usually made with a simple instrument termed a photometer, or color comparator. When the eye is replaced by a photoelectric cell (thus largely eliminating the errors due to the personal characteristics of each observer) the instrument is termed a photoelectric colorimeter, or photometer.

## Conditioning Solution

A specialized solution in which the electrode must be immersed in to activate the glass selective membrane.

## CPS™

Clogging Prevention System. Conventional pH electrodes use ceramic junctions that may clog quickly when used in biological samples such as wine. When the junction is blocked, the entire electrode will not function properly. Electrodes that feature CPS™ technology utilize a ground glass/PTFE sleeve junction which controls a steady, predictable flow of fill solution thus keeping the junction open. The hydrophobic property of PTFE sleeve repels wetness and coatings.

## CYAC

Cyanuric Acid

## °Dornic

Determined by titrating a 100 mL sample with N/9 sodium hydroxide to a phenolphthalein end point.

## Delrin

A plastic made from Acetal Homopolymer; a crystalline plastic that offers an excellent balance of properties that bridge the gap between metals and plastics.

## Detection Limit

In analytical chemistry, the detection limit LOD of an individual analytical procedure is the lowest amount of analyte in a sample which can be detected but not necessarily quantitated as an exact value; or the lowest quantity of a substance that can be distinguished from the absence of that substance (a blank value) within a stated confidence limit (generally 1%).

The detection limit is estimated from the mean of the blank, the standard deviation of the blank and some confidence factor. Another consideration that affects the detection limit is the accuracy of the model used to predict concentration from the raw analytical signal. There are a number of different "detection limits" that are commonly used. These include: the instrument detection limit (IDL), the method detection limit (MDL) and the limit of quantitation (LOQ).

Even when the same terminology is used, there can be differences in the LOD, according to nuances of what definition is used and what type of noise contributes to the measurement and calibration.

Most analytical instruments produce a signal even when a blank (matrix without analyte) is analyzed. This signal is referred to as the noise level.

The IDL is the analyte concentration that is required to produce a signal greater than three times the standard deviation of the noise level.

Many times there is more to the analytical method than just doing a reaction or submitting it to direct analysis. For example it might be necessary to heat a sample that is to be analyzed for a particular metal

with the addition of acid first (this is called digestion). The sample may also be diluted or concentrated prior to analysis on an instrument.

Additional steps in an analysis add additional opportunities for error.

Since detection limits are defined in terms of error, this will naturally increase the measured detection limit. This detection limit (with all steps of the analysis included) is called the MDL.

## Dew Point

The dew point is defined as the temperature to which air must be cooled in order for condensation (saturation) to occur. The dew point is dependent on the concentration of water vapor present, and therefore, the relative humidity.

## DIN Connector

A circular connector for consumer electronics, originally standardized by the Deutsches Institut für Normung (DIN) for analog audio signals.

## Direct Potentiometry

Direct Potentiometry is a widely used method of performing ion analysis with ISEs. This method is highly effective when the user must quickly measure large batches of samples at many concentrations. Hanna direct reading meters such as the HI 98184 and HI 98185 display concentration of the unknown sample by a direct reading after calibrating the instrument with two or more standards. Ionic strength adjustments are made to both samples and standards. In some applications quick and reliable measurements can be made on-site, without taking samples back to the laboratory.

## DiST®

Hanna Dissolved Solids Testers are widely used for monitoring EC/TDS in water conditioning, reverse osmosis, cooling towers, drinking water, wastewater, laboratories, agriculture, aquaculture and aquariums, hydroponics and the printing industry.

## dKH

Degrees of carbonate hardness.

In case of alkalinity: 1 dKH = 0.36 meq/L = 17.86 mg/L CaCO<sub>3</sub>

## DO

Dissolved Oxygen. A relative measure of the amount of oxygen that is dissolved or carried in a given medium.

## DPD

N,N-diethyl-p-phenylenediamine

## EBC

European Brewery Convention.

**EC**

Electrical conductivity is a measure of how well a material accommodates the transport of electric charge. Its SI derived unit is the Siemens per meter, (A2s3m-3kg-1) (named after Werner von Siemens). It is the ratio of the current density to the electric field strength. This applies also to the electrolytic conductivity of a fluid.

**EDTA**

Edetic acid; ethylenediaminetetraacetic acid

**EES**

Sodium exchangeable ( in meq/100 g soil)

**Electromagnetic Compatibility**

See page 16.4

**Electromagnetic Interferences (EMI)**

See page 16.4

**EPA (U.S. EPA)**

United States Environmental Protection Agency

**°F**

Fahrenheit temperature degree; °F = °C x 9/5 + 32

**FAO**

Food and Agriculture Organization

**Fast Tracker™–Tag Identification System**

Hanna's Fact Tracker™–Tag Identification System simplifies test logging. iButton®s with a unique ID can be installed at various sampling sites. When the matching connector on the meter contacts the location button, measurements are logged and labeled with the alphanumeric user-entered location ID. Location, date, time and measurements are logged into the meter which can be transferred to a PC.

**FDA**

US Food & Drug Administration.

FDA bottle = bottles that meet FDA Standards.

**Filling Solution**

Solution containing the anion to which the reference electrode of the operational pH cell is reversible, eg. Chloride for Ag-AgCl electrodes.

**FNU**

Formazin Nephelometric Unit.

**FTU**

Formazin Turbidity Unit.

**F.S. (or f.s.)**

Full scale

**Glass Membrane**

Hanna utilizes four different types of pH sensitive glass to cover a vast number of applications. Our manufacturing processes are specific for each pH electrode design. For instance, some electrodes with low impedance glass are particularly suited at performing measurements in solutions with low conductivity or cold solutions. For industrial grade electrodes, Hanna produces a specific range of sensitive glass that guarantees a linear response over a wide pH range as well as being resistant to harsh environments.

To optimize a pH measurement for a particular application, the pH glass characteristics are considered, as well as materials of construction including reference junctions, wetted materials and internal seals. Hanna provides the best materials and performance for a particular application to ensure reliable measurements.

<b>GP</b>	General Purpose
<b>HT</b>	High Temperature
<b>LT</b>	Low Temperature
<b>HF</b>	Samples with Fluoride

**GLP**

Good Laboratory Practice. The phrase good laboratory practice especially refers to a Quality System concerned with the organizational process and the conditions under which non-clinical health and environmental safety studies are planned, performed, monitored, recorded, archived and reported.

**GP Glass**

Hanna's GP (general purpose) hydrogen sensitive glass provides the best response over the entire pH range and can be used for a wide range of applications. Great results are obtained with sphere geometry with diameter of 9.5 mm (0.37"). This achieves a system with 100 MΩ impedance. The GP glass is also used on smaller diameter spheres.

**GPS**

Global Positioning System

**GR**

Gypsum Requirement (metric ton/ha or ton/acre).

**H<sub>2</sub>T**

Tartaric Acid.

**HACCP**

Hazard Analysis and Critical Control Points.

**HC**

Handheld Colorimeter.

## HF Glass

Hydrofluoric acid can dissolve glass rapidly. Hanna uses HF resistant glass for aggressive applications that have fluoride ions. Electrodes manufactured with this glass live ten times longer than electrodes made with standard pH glass formulations (from 10 days to 100 days). The alkaline error is very high for this glass so it is not suited for pH measurements above pH 10. The recommended pH range with this glass is 2-10 pH.

## High Input Impedance Meter

It is the measurement device that processes the voltage from the electrochemical cell and converts it into a meaningful measurement unit (pH). The measurement is done with virtually zero current flow to prevent polarization of the electrodes. Modern pH meters also may provide sensor diagnostics, automatic buffer recognition, calibration reminders and user prompts.

## HOLD Function

Function that lets the user know when to take readings and freezes the readings on display for easy and accurate recording.

## HPLC

High Performance Liquid Chromatography.

## HR

High Range.

## HT Glass

Designed for extended use at elevated temperature. The glass impedance has a temperature coefficient of about 14.3% per degree Celsius. HT sensitive glass has an impedance of 400M $\Omega$  at approximately 25°C (77°F). At extremely high temperatures, the impedance drops significantly. This glass makes it possible to obtain accurate, high temperature pH measurements for extended periods of time 90°C (194°F) and for a few weeks at 100°C (212°F). At room temperature, the response time may increase so additional time for equilibration in buffers should be allowed. This glass is clear.

## HVAC

Heating, Ventilating, and Air Conditioning - refers to technology of indoor or automotive environmental comfort.

## Hygrometer

The hygrometer is an instrument used to measure relative humidity (RH), that is, the quantity of water vapor present in the air. Hygrometers are often available in versions that also measure temperature—these are normally called thermohygrometers.

## IARC

International Agency for Research on Cancer

## iButton® Tags

Install the optional TAGs near your sampling points for quick and easy iButton® readings. Each TAG contains a computer chip with a unique identification code encased in stainless steel. Users can order and install a virtually unlimited amount of TAGs to meet any need of traceability requirements.

## ICUMSA

International Commission for Uniform Methods of Sugar Analysis.

## Incremental Method

Incremental Methods are useful techniques used to determine ion concentration quickly in samples whose constituents are variable or concentrated. Incremental Methods have some inherent advantages over direct potentiometry. The techniques can reduce errors from variables such as temperature, viscosity, pH or ionic strength. The electrodes remain immersed throughout the process thus reducing sample carry over and possible liquid junction changes in the reference and analysis steps are reduced. Known addition, known subtraction, analyte addition, and analyte subtraction methods are four of these incremental techniques. All techniques involve adding a standard to the sample, or sample to the standard and the meter calculates the sample's ion concentration directly.

## IP

Ingress Protection. See page 16.3

## IR

Infrared. Electromagnetic radiation with a wavelength longer than VIS (according to CIE the IR band is 700 nm to 1 mm).

## ISA

Ionic Strength Adjusters (ISA) are formulated to provide a constant ionic strength in sample and standards alike, thus permitting concentration rather than activity measurements to be made. In some cases ISA's adjust pH and eliminate matrix effects.

## ISE

Ion Selective Electrode, also known as a specific ion electrode. ISE's are sensors that convert the activity of a specific ion dissolved in a solution into an electrical potential, which can be measured by a pH meter or a voltmeter.

## ISO Standards

See page 16.5

## ISOPOTENTIAL pH

Is the pH at which the cell voltage does not change when the temperature changes.

## ISSS

International Society of Soil Science.

## ITS

International Temperature Scale.

## Junction

The junction (the part in contact between the two liquids) is typically made with inert materials that will not increase a junction potential or be chemically attacked by the measured solutions.

## JTU

Jackson Turbidity Unit.

## KEY®

The KEY is a thermometer with an interchangeable probe for quick spot measurements. With a response time of less than 20 seconds in water, KEY is ideal for QC and industrial temperature monitoring.

## KHT

Potassium Bi-Tartrate.

## °KMW

°Klosterneuburger Mostwaage is used in Austria to measure the sugar content of must. °KMW is also known as °Babo.

°KMW is related to °Oe by the following equation:  $^{\circ}\text{Oe} = ^{\circ}\text{KMW} \times [(0.022 \times ^{\circ}\text{KMW}) + 4.54]$

1 °KMW is roughly equivalent to 1 %Brix or 5 °Oe.

## % l.a.

Percent lactic acid is determined by titrating a 20 mL or 20 g sample diluted with twice its volume of deionized or distilled water with 0.1 M sodium hydroxide to a phenolphthalein end point.

## LCD

Liquid Crystal Display.

## LDL Cholesterol

Low-density lipoprotein cholesterol.

## LED

Light-emitting diode; a semiconductor light source.

## LI

Langelier Index is a saturation index developed by Dr. Wilfred Langelier and is widely used to predict the balance of swimming pool waters. It is an estimation of the solutions ability to dissolve or precipitate calcium carbonate deposits.

## Linearity

The linearity of an analytical procedure is its ability (within a given range) to obtain test results which are directly proportional to the concentration of analyte in the sample.

## LOAEL

Lowest-observed-adverse-effect level.

## LR

Low Range.

## LSD

Low Significant Digit.

## LT Glass

This glass is used on our flat and conical shaped membranes as well as sensors used at cold temperatures, because the glass has lower impedance. If an electrode has very high impedance, the measurement response will be sluggish, and a voltage drop causing error can occur. At temperatures below -8°C (17°F) the internal buffer may freeze and expand and cause the mechanical destruction of the sensor. This glass has a more limited pH range and is dark green.

## Lux (lx)

The SI unit of illuminance and luminous emittance measuring luminous power per area.

## Matching Pin

A matching pin is a differential measurement technique used to eliminate ground loops and common mode perturbations for the measurement system. In a system without a matching pin, electrical currents in the sample can affect the reference half cell voltage that is connected via the liquid junction with the sample.

In this case, the reference electrode picks up the electromagnetic fields and the measurement of the pH is altered. The matching pin isolates these current/magnetic fields from the reference electrode. Hanna manufactures a number of models with the matching pin design for safe precise pH measurements.

## MEADOS

Measuring and Dosing System.

## MEBAK

Central European Brewing Commission.

## meq/L

Milliequivalents per liter.

In case of alkalinity:  $1 \text{ meq/L} = 50 \text{ mg/L CaCO}_3 = 2.8 \text{ dKH}$ .

**Mho/cm**

see S/cm.

**Millesimal pH Buffer**

This line of buffers with millesimal accuracy ( $\pm 0.002$  pH), has been prepared to meet the increasing need for assured accuracy in pH measurements. Each bottle is provided with a certificate of analysis, prepared by comparison with NIST standards.

**MR**

Medium Range.

**MTC**

Manual Temperature Compensation. The temperature value, shown on the LCD, can be manually set. The compensation is referenced at the selected temperature.

**mV**

1/1000 of a volt, a measure of electrical potential (voltage).

**NIST**

National Institute of Standards and Technology.

**nm**

Nanometer. Unit of measurement for length in the metric system, equal to one billionth of a meter.

**NoTC**

No Temperature Compensation. For actual conductivity or TDS measurement, the temperature value shown on the LCD is not taken into account.

**NPK**

Nitrogen, phosphorus, and potassium.

**NPT**

National Pipe Thread. A U.S. standard for tapered threads used on threaded pipes and fittings.

**NTU**

Nephelometric Turbidity Unit.

**°Oechsle (°Oe)**

°Oechsle is mainly used in the German, Swiss and Luxemburgish winemaking industry to measure the sugar content of must. The °Oe scale, one degree Oechsle corresponds to one gram of difference between the mass of one liter of must at 20°C and 1 kg (the mass of 1 liter of water at same temperature).

**Open Junction**

This type junction, found in reference half-cells, is filled with a special gel which comes into direct contact with the solution to be measured. An advantage of an open junction is low contact resistance and it is virtually impossible to clog.

**Opto-isolator**

In electronics, an opto-isolator is an electronic device designed to transfer electrical signals by utilizing light waves to provide coupling with electrical isolation between its input and output.

**ORP**

Oxidation Reduction Potential. Solutions can be graded as oxidizing or reducing based on measurement of ORP values.

**OSHA**

The Occupational Safety and Health Administration.

**OUR**

Oxygen Uptake Rate. Used to determine the oxygen consumption or respiration rate; is measured in mg of oxygen consumed per liter per hour.

**PAN**

1-(2-pyridylazo)-2-naphtol (indicator)

**PCU**

Platinum Cobalt Unit.

**PD Controller**

Proportional Derivative controller.

**PEI**

Polyetherimide.

**PELs**

Standards for the length and intensity of exposure to certain elements.

**Pfund Scale**

The Pfund scale is a color grader used to provide readings of the range of honey colors. There are seven color classifications for processed honey; water white, extra white, white, extra light amber, light amber, amber and dark amber. Traditionally, the Pfund color grader works by visually comparing a wedge-shaped glass container of honey with an amber glass wedge.

**pH [NIST]**

The negative logarithm of the hydrogen ion activity has been given the symbol pH. The original definition was in terms of hydrogen ion concentration. The present definition of pH is associated with the "effective" concentration of hydrogen ion.

### pH Glass Electrode [IUPAC]

Hydrogen ion responsive electrode usually consists of a bulb, or other suitable form of special glass attached to a stem of high-resistance glass complete with internal reference electrode and internal filling solution system. Other geometrical forms may be appropriate for special applications.

### Photometer

An instrument used for measuring of photometric quantities by means of a photoreceptor.

### PID Controller

Proportional-Integral-Derivative controller.

### PLC

Programmable Logic Controller.

### Potentiometric Titration

A Potentiometric Titration can increase the precision of ISE measurements and also the number of ionic species that can be determined. ISEs are commonly used as indicators for the titrant or sample species to follow the progress of a precipitation or complexometric titration. A small change in reactant addition corresponds to a large change in electrode potential at its stoichiometric endpoint. An example of a precipitation titration is the determination of chloride using silver nitrate. A silver ISE can be used to follow this titration. A complexometric titration is used for the determination of calcium. A calcium solution is titrated with the complexing reagent EDTA. During the titration, there is a gradual decrease in the free  $\text{Ca}^{2+}$  ion concentrations as more EDTA is added. The endpoint corresponds to the point when all the  $\text{Ca}^{2+}$  is complexed. The progress of this titration can be monitored using a calcium ISE.

### ppb

parts per billion; as concentration: 1 ppb = 1  $\mu\text{g}$  substance /L solution.

### ppm

parts per million; as concentration: 1 ppm = 1 mg substance /L solution; 1% = 10000 ppm.

### ppt

parts per thousand; as concentration: 1 ppt = 1 g substance /L solution.

### Pre-amplified Electrode

Hanna electrode containing an internal pre-amplifier. The pre-amplifier converts the high impedance signal from the pH glass to a low impedance signal thus allowing the user to use long runs of sensor cable with ordinary connectors without noisy or voltage drops resulting in erroneous measurements.

### Precision

The precision of an analytical procedure expresses the closeness of agreement (degree of scatter) between a series of measurements obtained from multiple sampling of the same homogeneous sample under the prescribed conditions. Precision may be considered at three levels: repeatability, intermediate precision and reproducibility.

Precision should be investigated using homogeneous, authentic samples. However, if it is not possible to obtain a homogeneous sample it may be investigated using artificially prepared samples or a sample solution.

The precision of an analytical procedure is usually expressed as the variance, standard deviation or coefficient of variation of a series of measurements.

Intermediate precision expresses within-laboratories variations: different days, different analysts, different equipment, etc.

### Pt100

The most common RTD sensor using platinum is the Pt100, which means a resistance of 100 $\Omega$  at 0°C with a temperature coefficient of 0.00385 $\Omega$  per degree Celsius. Similar for Pt1000.

### PTFE

PolyTetraFluoroEthylene. Porous PTFE is a hydrophobic material that is available with different porosities. Because of its chemical advantages, PTFE is widely used in industrial applications.

### PVC

Polyvinyl chloride.

### PVDF

Polyvinylidene Fluoride—a highly non-reactive and pure thermoplastic fluoropolymer.

### PWT

Pure Water Test.

### QC

Quality Control.

### Range

The range of an analytical procedure is the interval between the upper and lower concentrations of analyte in the sample (including these concentrations) for which it has been demonstrated that the analytical procedure has a suitable level of precision, accuracy and linearity.

### RDT

Resistance Temperature Detectors.

## Reference Electrode

Half cell of the electrochemical cell that supplies a stable voltage that is known, constant and completely insensitive to the measurement solution. Changes in voltages generated from the pH sensor are measured versus this electrode's voltage.

## Refractive Index

Refractive Index is defined as the ratio of the speed of light in empty space to the speed of light in the substance.

## Repeatability

Repeatability expresses the precision under the same operating conditions over a short interval of time. Repeatability is also termed intra-assay precision.

## Reproducibility

Reproducibility expresses the precision between laboratories collaborative studies, (usually applied to standardization of methodology).

## Resistivity

Electrical resistivity (also known as specific electrical resistance) is a measure indicating how strongly a material opposes the flow of electric current. A low resistivity indicates a material that readily allows the movement of electrons. The SI unit for electrical resistivity is the ohm meter.

## RH

Relative humidity is expressed as the ratio of the quantity of water vapor present in the air to the quantity at which the air would reach saturation (100%) at a given temperature.

## Robustness

The robustness of an analytical procedure is a measure of its capacity to remain unaffected by small, but deliberate variations in method parameters and provides an indication of its reliability during normal usage.

## rpm

Revolutions per minute.

## RS

Reducing Sugars.

## RS232

In telecommunications, RS-232 (Recommended Standard 232) is traditional name for a series of standards for serial binary single-ended data and control signals.

## RS485

In telecommunications, RS-485 (Recommended Standard 485) is a standard defining the electrical characteristics of drivers and receivers for use in balanced digital multipoint systems. RS-485 can be used effectively over long distances and in electrically noisy environments.

## S/cm

The siemens (S) unit is named after Werner von Siemens, the 19th century German inventor and entrepreneur in the area of electrical engineering. Previously to the siemens per meter unit, mho/cm was used to measure conductivity, where the unit "mho" is a reciprocal ohm. The "mho" is "ohm" spelled backwards. Because of the history of conductivity,  $\mu\text{mho/cm}$  and  $\text{mmho/cm}$  is commonly translated to  $\mu\text{S/cm}$  and  $\text{mS/cm}$  because they correspond one-to-one.

The unit of measurement commonly used is one millionth of a Siemens per centimeter (micro-Siemens per centimeter or  $\mu\text{S/cm}$ ).

When measuring more concentrated solutions, the units are expressed as milli-Siemens/cm or  $\text{mS/cm}$  (thousandths of a Siemens). For ease of expression, 1000  $\mu\text{S/cm}$  are equal to 1  $\text{mS/cm}$ .

## Salinity

Salinity is a measurement without the unit corresponding to the weight of dissolved salts in seawater. Salinity is calculated from an empirical relationship between the conductivity and the salinity of a seawater sample. Oceanographic Tables and Standards endorsed by UNESCO/SCOR/ICES/IAPSO are used for the calculation.

Salinity measurements are performed with no direct temperature correction. The salinity range is calibrated using a standard sea water solution.

## SAR

Sodium Absorbance Ratio (meq/L).

## Sensor Check™

Allows users to check electrode status at any time.

## °SH

Soxlet Henkel degrees is determined by titrating a 50 mL sample with 0.1 M sodium hydroxide to a phenolphthalein end point.

## SHE

Standard Hydrogen Electrode.

## SMART electrode

With models that feature our SMART circuitry, an exclusive microchip embedded inside the electrode retains the calibration data and assigns an identity code to the host unit. As soon as the electrode is connected to a pH meter in the SMART series, it is recognized and its characteristics retrieved. The meter then uses the accessed calibration data as a reference for future measurements. Once



each SMART electrode is calibrated, these electrodes can be used in succession without requiring new calibration. Hanna's intelligent electrodes help eliminate errors and will save time when working with more than one electrode.

## SOP

Standard Operating Procedures means documented procedures which describe how to perform tests or activities normally not specified in detail in study plans or tests guidelines.

## SOUR

Specific Oxygen Uptake Rate. This is used to determine the oxygen consumption or respiration rate; SOUR is measured in mg of oxygen consumed per gram of volatile suspended solids per hour.

## SPDT relay

Single Pole Double Throw relay.

## Specificity

Specificity is the ability to assess unequivocally the analyte in the presence of components which may be expected to be present. Typically these might include impurities, degradants, matrix, etc.

## Speedsafe™

Each Hanna stirrer is equipped with a speed sensing device (opto-sensor) coupled with an FVC (frequency voltage converter), which monitors the speed. As the speed reaches a preset maximum level, the speed limiter shuts down the VCO to slow down the motor speed. This ensures that when the load is suddenly removed from the stirrer, the motor will not accelerate to such a high speed that will be hazardous to both the user and the stirrer; a feature not commonly found in conventional stirrers.

## SPST Relay

Single Pole Single Throw relay.

## SRM

Standard Reference Material (CRM of National Institute of Standards and Technology).

## Storage Solution

Solution used to keep the electrode moist when not in use.

## TDS

Total Dissolved Solids (often abbreviated TDS) is a measure of the combined content of all inorganic and organic substances contained in a liquid in: molecular, ionized or micro-granular (colloidal sol) suspended form.

## TDS Factor

When a solution does not have a similar ionic content to natural water or salt water, then a TDS conversion factor is needed to automatically adjust the readings.  $TDS = CF \times \text{conductivity}$  (CF is TDS Conversion factor).

## TFPC

Thin Film Polymer Capacitance.

## TEA

Total Exchangeable Acidity - A measure of the amount of acidic cations (hydrogen, aluminum, iron and manganese) present in soil. It is expressed in Milliequivalents per 100 grams (meq/100 g) of soil.

## °Th

Degree Thörner is determined by titrating a 10 mL sample diluted with twice its volume of deionized or distilled water with 0.1 M sodium hydroxide to a phenolphthalein end point.

## Timer Function

Counts down to appropriate time interval before a reading is displayed. This feature ensures consistency in measurements.

## TPTZ

2,4,6-tri-(2-pyridyl)-1,3,5-triazine (iron indicator)

## Traceability [IUPAC]

Property of the result of a measurement or the value of a standard whereby it can be related to stated references, usually national or international standards, through an unbroken chain of comparisons all having stated uncertainties. The concept is often expressed by the adjective traceable. The unbroken chain of comparisons is called a traceability chain.

## Turbidity

Turbidity of water is an optical property that causes light to be scattered and absorbed, rather than transmitted. The scattering of the light that passes through a liquid is primarily caused by the suspended solids. The higher the turbidity, the greater the amount of scattered light. Because even the molecules in a very pure fluid scatter light to a certain degree, no solution will have zero turbidity.

## UPW

Ultra Pure Water.

## USB

Universal Serial Bus is a application to establish communication between various devices and a host controller (usually a PC).

## USDA

United States Department of Agriculture.

### USP

US Pharmacopoeia. USP <645> with Stage 1, 2 and 3 compliance is required for purified water and WFI (water for injection). Hanna offers instruments that are able to perform all three stages required by this standard. Some of these requirements are: Resolution of 0.1  $\mu\text{S}/\text{cm}$  or better, accuracy at 1.3 $\mu\text{S}/\text{cm}$  of 0.1 $\mu\text{S}/\text{cm}$ , to be able to read with or without automatic temperature compensation, the cell constant be known with an uncertainty better than  $\pm 2\%$ .

### UV

Ultraviolet–electromagnetic radiation with a wavelength shorter than that of VIS, but longer than X-rays (10-400 nm).

### VCO

Voltage Controlled Oscillator.

### VIS

The visible spectrum - is the portion of the electromagnetic spectrum that is visible (can be detected by) to the human eye (390 - 750 nm for typical human eye).

### WHO

World Health Organization.

## Relative Humidity in air as a function of temperature of some saturated salt solutions

Temperature °C	Lithium Chloride	Potassium Acetate	Magnesium Chloride	Potassium Carbonate	Magnesium Nitrate
0	11.23 ± 0.54		33.66 ± 0.33	43.13 ± 0.66	60.35 ± 0.55
5	11.26 ± 0.47		33.60 ± 0.28	43.13 ± 0.50	58.86 ± 0.43
10	11.29 ± 0.41	23.28 ± 0.53	33.47 ± 0.24	43.14 ± 0.39	57.36 ± 0.33
15	11.30 ± 0.35	23.40 ± 0.32	33.30 ± 0.21	43.15 ± 0.33	55.87 ± 0.27
20	11.31 ± 0.31	23.11 ± 0.25	33.07 ± 0.18	43.16 ± 0.33	54.38 ± 0.23
25	11.30 ± 0.27	22.51 ± 0.32	32.78 ± 0.16	43.16 ± 0.39	52.89 ± 0.22
30	11.28 ± 0.24	21.61 ± 0.53	32.44 ± 0.14	43.17 ± 0.50	51.40 ± 0.24
35	11.25 ± 0.22		32.05 ± 0.13		49.91 ± 0.29
40	11.21 ± 0.21		31.60 ± 0.13		48.42 ± 0.37
45	11.16 ± 0.21		31.10 ± 0.13		46.93 ± 0.47
50	11.10 ± 0.22		30.54 ± 0.13		45.44 ± 0.60
55	11.03 ± 0.23		29.93 ± 0.16		
60	10.95 ± 0.26		29.26 ± 0.18		
65	10.86 ± 0.29		28.54 ± 0.21		
70	10.75 ± 0.33		27.77 ± 0.25		
75	10.64 ± 0.38		26.94 ± 0.29		
80	10.51 ± 0.44		26.05 ± 0.34		
85	10.38 ± 0.51		25.11 ± 0.39		
90	10.23 ± 0.59		24.12 ± 0.46		
95	10.07 ± 0.67		23.07 ± 0.52		
100	9.90 ± 0.77		21.97 ± 0.60		

## Relative Humidity in air as a function of temperature of some saturated salt solutions

Temperature °C	Sodium Chloride	Potassium Chloride	Potassium Nitrate	Potassium Sulfate
0	75.51 ± 0.34	88.61 ± 0.53	96.33 ± 2.90	98.77 ± 1.10
5	76.65 ± 0.27	87.67 ± 0.45	96.27 ± 2.10	98.48 ± 0.91
10	75.67 ± 0.22	86.77 ± 0.39	95.96 ± 1.40	98.18 ± 0.76
15	75.61 ± 0.18	85.92 ± 0.33	95.41 ± 0.96	97.89 ± 0.63
20	75.47 ± 0.14	85.11 ± 0.29	94.62 ± 0.66	97.59 ± 0.53
25	75.29 ± 0.12	84.34 ± 0.26	93.58 ± 0.55	97.30 ± 0.45
30	75.09 ± 0.11	83.62 ± 0.25	93.21 ± 0.60	97.00 ± 0.40
35	74.87 ± 0.12	82.95 ± 0.25	90.79 ± 0.83	96.71 ± 0.38
40	74.68 ± 0.13	82.32 ± 0.25	89.03 ± 1.20	96.41 ± 0.38
45	74.52 ± 0.16	81.74 ± 0.28	87.03 ± 1.80	96.12 ± 0.40
50	74.43 ± 0.19	81.20 ± 0.31	84.78 ± 2.50	95.82 ± 0.45
55	74.41 ± 0.24	80.70 ± 0.35		
60	74.50 ± 0.30	80.25 ± 0.41		
65	74.71 ± 0.37	79.85 ± 0.48		
70	75.06 ± 0.45	79.49 ± 0.57		
75	75.58 ± 0.55	79.17 ± 0.66		
80	76.29 ± 0.65	78.90 ± 0.77		
85		78.68 ± 0.89		
90		78.50 ± 1.00		
95				
100				

# Thermocouple Reference Tables

Reference Tables  
N.I.S.T Rev. ITS-90

## K-type thermocouple - Temperature in degrees "C" with reference junction at 0°C

°C	0	-1	-2	-3	-4	-5	-6	-7	-8	-9	-10	°C
-270	-6.458											-270
-260	-6.441	-6.444	-6.446	-6.448	-6.450	-6.452	-6.453	-6.455	-6.456	-6.457	-6.458	-260
-250	-6.404	-6.408	-6.413	-6.417	-6.421	-6.425	-6.429	-6.432	-6.435	-6.438	-6.441	-250
-240	-6.344	-6.351	-6.358	-6.364	-6.370	-6.377	-6.382	-6.388	-6.393	-6.399	-6.404	-240
-230	-6.262	-6.271	-6.280	-6.289	-6.297	-6.306	-6.314	-6.322	-6.329	-6.337	-6.344	-230
-220	-6.158	-6.170	-6.181	-6.192	-6.202	-6.213	-6.223	-6.233	-6.243	-6.252	-6.262	-220
-210	-6.035	-6.048	-6.061	-6.074	-6.087	-6.099	-6.111	-6.123	-6.135	-6.147	-6.158	-210
-200	-5.891	-5.907	-5.922	-5.936	-5.951	-5.965	-5.980	-5.994	-6.007	-6.021	-6.035	-200
-190	-5.730	-5.747	-5.763	-5.780	-5.797	-5.813	-5.829	-5.845	-5.861	-5.876	-5.891	-190
-180	-5.550	-5.569	-5.588	-5.606	-5.624	-5.642	-5.660	-5.678	-5.695	-5.713	-5.730	-180
-170	-5.354	-5.374	-5.395	-5.415	-5.435	-5.454	-5.474	-5.493	-5.512	-5.531	-5.550	-170
-160	-5.141	-5.163	-5.185	-5.207	-5.228	-5.250	-5.271	-5.292	-5.313	-5.333	-5.354	-160
-150	-4.913	-4.936	-4.960	-4.983	-5.006	-5.029	-5.052	-5.074	-5.097	-5.119	-5.141	-150
-140	-4.669	-4.694	-4.719	-4.744	-4.768	-4.793	-4.817	-4.841	-4.865	-4.889	-4.913	-140
-130	-4.411	-4.437	-4.463	-4.490	-4.516	-4.542	-4.567	-4.593	-4.618	-4.644	-4.669	-130
-120	-4.138	-4.166	-4.194	-4.221	-4.249	-4.276	-4.303	-4.330	-4.357	-4.384	-4.411	-120
-110	-3.852	-3.882	-3.911	-3.939	-3.968	-3.997	-4.025	-4.054	-4.082	-4.110	-4.138	-110
-100	-3.554	-3.584	-3.614	-3.645	-3.675	-3.705	-3.734	-3.764	-3.794	-3.823	-3.852	-100
-90	-3.243	-3.274	-3.306	-3.337	-3.368	-3.400	-3.431	-3.462	-3.492	-3.523	-3.554	-90
-80	-2.920	-2.953	-2.986	-3.018	-3.050	-3.083	-3.115	-3.147	-3.179	-3.211	-3.243	-80
-70	-2.587	-2.620	-2.654	-2.688	-2.721	-2.755	-2.788	-2.821	-2.854	-2.887	-2.920	-70
-60	-2.243	-2.278	-2.312	-2.347	-2.382	-2.416	-2.450	-2.485	-2.519	-2.553	-2.587	-60
-50	-1.889	-1.925	-1.961	-1.996	-2.032	-2.067	-2.103	-2.138	-2.173	-2.208	-2.243	-50
-40	-1.527	-1.564	-1.600	-1.637	-1.673	-1.709	-1.745	-1.782	-1.818	-1.854	-1.889	-40
-30	-1.156	-1.194	-1.231	-1.268	-1.305	-1.343	-1.380	-1.417	-1.453	-1.490	-1.527	-30
-20	-0.778	-0.816	-0.854	-0.892	-0.930	-0.968	-1.006	-1.043	-1.081	-1.119	-1.156	-20
-10	-0.392	-0.431	-0.470	-0.508	-0.547	-0.586	-0.624	-0.663	-0.701	-0.739	-0.778	-10
0	0.000	-0.039	-0.079	-0.118	-0.157	-0.197	-0.236	-0.275	-0.314	-0.353	-0.392	0
°C	0	1	2	3	4	5	6	7	8	9	10	°C
0	0.000	0.039	0.079	0.119	0.158	0.198	0.238	0.277	0.317	0.357	0.397	0
10	0.397	0.437	0.477	0.517	0.557	0.597	0.637	0.677	0.718	0.758	0.798	10
20	0.798	0.838	0.879	0.919	0.960	1.000	1.041	1.081	1.122	1.163	1.203	20
30	1.203	1.244	1.285	1.326	1.366	1.407	1.448	1.489	1.530	1.571	1.612	30
40	1.612	1.653	1.694	1.735	1.776	1.817	1.858	1.899	1.941	1.982	2.023	40
50	2.023	2.064	2.106	2.147	2.188	2.230	2.271	2.312	2.354	2.395	2.436	50
60	2.436	2.478	2.519	2.561	2.602	2.644	2.685	2.727	2.768	2.810	2.851	60
70	2.851	2.893	2.934	2.976	3.017	3.059	3.100	3.142	3.184	3.225	3.267	70
80	3.267	3.308	3.350	3.391	3.433	3.474	3.516	3.557	3.599	3.640	3.682	80
90	3.682	3.723	3.765	3.806	3.848	3.889	3.931	3.972	4.013	4.055	4.096	90
100	4.096	4.138	4.179	4.220	4.262	4.303	4.344	4.385	4.427	4.468	4.509	100
110	4.509	4.550	4.591	4.633	4.674	4.715	4.756	4.797	4.838	4.879	4.920	110
120	4.920	4.961	5.002	5.043	5.084	5.124	5.165	5.206	5.247	5.288	5.328	120
130	5.328	5.369	5.410	5.450	5.491	5.532	5.572	5.613	5.653	5.694	5.735	130
140	5.735	5.775	5.815	5.856	5.896	5.937	5.977	6.017	6.058	6.098	6.138	140
150	6.138	6.179	6.219	6.259	6.299	6.339	6.380	6.420	6.460	6.500	6.540	150
160	6.540	6.580	6.620	6.660	6.701	6.741	6.781	6.821	6.861	6.901	6.941	160
170	6.941	6.981	7.021	7.060	7.100	7.140	7.180	7.220	7.260	7.300	7.340	170
180	7.340	7.380	7.420	7.460	7.500	7.540	7.579	7.619	7.659	7.699	7.739	180
190	7.739	7.779	7.819	7.859	7.899	7.939	7.979	8.019	8.059	8.099	8.138	190
200	8.138	8.178	8.218	8.258	8.298	8.338	8.378	8.418	8.458	8.499	8.539	200
210	8.539	8.579	8.619	8.659	8.699	8.739	8.779	8.819	8.860	8.900	8.940	210
220	8.940	8.980	9.020	9.061	9.101	9.141	9.181	9.222	9.262	9.302	9.343	220
230	9.343	9.383	9.423	9.464	9.504	9.545	9.585	9.626	9.666	9.707	9.747	230
240	9.747	9.788	9.828	9.869	9.909	9.950	9.991	10.031	10.072	10.113	10.153	240
250	10.153	10.194	10.235	10.276	10.316	10.357	10.398	10.439	10.480	10.520	0.561	250
260	10.561	10.602	10.643	10.684	10.725	10.766	10.807	10.848	10.889	10.930	10.971	260
270	10.971	11.012	11.053	11.094	11.135	11.176	11.217	11.259	11.300	11.341	11.382	270
280	11.382	11.423	11.465	11.506	11.547	11.588	11.630	11.671	11.712	11.753	11.795	280
290	11.795	11.836	11.877	11.919	11.960	12.001	12.043	12.084	12.126	12.167	12.209	290
300	12.209	12.250	12.291	12.333	12.374	12.416	12.457	12.499	12.540	12.582	12.624	300
310	12.624	12.665	12.707	12.748	12.790	12.831	12.873	12.915	12.956	12.998	13.040	310
320	13.040	13.081	13.123	13.165	13.206	13.248	13.290	13.331	13.373	13.415	13.457	320
330	13.457	13.498	13.540	13.582	13.624	13.665	13.707	13.749	13.791	13.833	13.874	330
340	13.874	13.916	13.958	14.000	14.042	14.084	14.126	14.167	14.209	14.251	14.293	340
350	14.293	14.335	14.377	14.419	14.461	14.503	14.545	14.587	14.629	14.671	14.713	350
360	14.713	14.755	14.797	14.839	14.881	14.923	14.965	15.007	15.049	15.091	15.133	360
370	15.133	15.175	15.217	15.259	15.301	15.343	15.385	15.427	15.469	15.511	15.554	370
380	15.554	15.596	15.638	15.680	15.722	15.764	15.806	15.849	15.891	15.933	15.975	380
390	15.975	16.017	16.059	16.102	16.144	16.186	16.228	16.270	16.313	16.355	16.397	390
400	16.397	16.439	16.482	16.524	16.566	16.608	16.651	16.693	16.735	16.778	16.820	400
410	16.820	16.862	16.904	16.947	16.989	17.031	17.074	17.116	17.158	17.201	17.243	410
420	17.243	17.285	17.328	17.370	17.413	17.455	17.497	17.540	17.582	17.624	17.667	420
430	17.667	17.709	17.752	17.794	17.837	17.879	17.921	17.964	18.006	18.049	18.091	430
440	18.091	18.134	18.176	18.218	18.261	18.303	18.346	18.388	18.431	18.473	18.516	440
450	18.516	18.558	18.601	18.643	18.686	18.728	18.771	18.813	18.856	18.898	18.941	450
460	18.941	18.983	19.026	19.068	19.111	19.154	19.196	19.239	19.281	19.324	19.366	460
470	19.366	19.409	19.451	19.494	19.537	19.579	19.622	19.664	19.707	19.750	19.792	470
480	19.792	19.835	19.877	19.920	19.962	20.005	20.048	20.090	20.133	20.175	20.218	480
490	20.218	20.261	20.303	20.346	20.389	20.431	20.474	20.516	20.559	20.602	20.644	490
500	20.644	20.687	20.730	20.772	20.815	20.857	20.900	20.943	20.985	21.028	21.071	500
510	21.071	21.113	21.156	21.199	21.241	21.284	21.326	21.369	21.412	21.454	21.497	510
520	21.497	21.540	21.582	21.625	21.668	21.710	21.753	21.796	21.838	21.881	21.924	520
530	21.924	21.966	22.009	22.052	22.094	22.137	22.179	22.222	22.265	22.307	22.350	530
540	22.350	22.393	22.435	22.478	22.521	22.563	22.606	22.649	22.691	22.734	22.776	540

# Thermocouple Reference Tables

## K-type thermocouple - Temperature in degrees "C" with reference junction at 0°C

°C	0	1	2	3	4	5	6	7	8	9	10	°C
550	22.776	22.819	22.862	22.904	22.947	22.990	23.032	23.075	23.117	23.160	23.203	550
560	23.203	23.245	23.288	23.331	23.373	23.416	23.458	23.501	23.544	23.586	23.629	560
570	23.629	23.671	23.714	23.757	23.799	23.842	23.884	23.927	23.970	24.012	24.055	570
580	24.055	24.097	24.140	24.182	24.225	24.267	24.310	24.353	24.395	24.438	24.480	580
590	24.480	24.523	24.565	24.608	24.650	24.693	24.735	24.778	24.820	24.863	24.905	590
600	24.905	24.948	24.990	25.033	25.075	25.118	25.160	25.203	25.245	25.288	25.330	600
610	25.330	25.373	25.415	25.458	25.500	25.543	25.585	25.627	25.670	25.712	25.755	610
620	25.755	25.797	25.840	25.882	25.924	25.967	26.009	26.052	26.094	26.136	26.179	620
630	26.179	26.221	26.263	26.306	26.348	26.390	26.433	26.475	26.517	26.560	26.602	630
640	26.602	26.644	26.687	26.729	26.771	26.814	26.856	26.898	26.940	26.983	27.025	640
650	27.025	27.067	27.109	27.152	27.194	27.236	27.278	27.320	27.363	27.405	27.447	650
660	27.447	27.489	27.531	27.574	27.616	27.658	27.700	27.742	27.784	27.826	27.869	660
670	27.869	27.911	27.953	27.995	28.037	28.079	28.121	28.163	28.205	28.247	28.289	670
680	28.289	28.332	28.374	28.416	28.458	28.500	28.542	28.584	28.626	28.668	28.710	680
690	28.710	28.752	28.794	28.835	28.877	28.919	28.961	29.003	29.045	29.087	29.129	690
700	29.129	29.171	29.213	29.255	29.297	29.338	29.380	29.422	29.464	29.506	29.548	700
710	29.548	29.589	29.631	29.673	29.715	29.757	29.798	29.840	29.882	29.924	29.965	710
720	29.965	30.007	30.049	30.090	30.132	30.174	30.216	30.257	30.299	30.341	30.382	720
730	30.382	30.424	30.466	30.507	30.549	30.590	30.632	30.674	30.715	30.757	30.798	730
740	30.798	30.840	30.881	30.923	30.964	31.006	31.047	31.089	31.130	31.172	31.213	740
750	31.213	31.255	31.296	31.338	31.379	31.421	31.462	31.504	31.545	31.586	31.628	750
760	31.628	31.669	31.710	31.752	31.793	31.834	31.876	31.917	31.958	32.000	32.041	760
770	32.041	32.082	32.124	32.165	32.206	32.247	32.289	32.330	32.371	32.412	32.453	770
780	32.453	32.495	32.536	32.577	32.618	32.659	32.700	32.742	32.783	32.824	32.865	780
790	32.865	32.906	32.947	32.988	33.029	33.070	33.111	33.152	33.193	33.234	33.275	790
800	33.275	33.316	33.357	33.398	33.439	33.480	33.521	33.562	33.603	33.644	33.685	800
810	33.685	33.726	33.767	33.808	33.848	33.889	33.930	33.971	34.012	34.053	34.093	810
820	34.093	34.134	34.175	34.216	34.257	34.297	34.338	34.379	34.420	34.460	34.501	820
830	34.501	34.542	34.582	34.623	34.664	34.704	34.745	34.786	34.826	34.867	34.908	830
840	34.908	34.948	34.989	35.029	35.070	35.110	35.151	35.192	35.232	35.273	35.313	840
850	35.313	35.354	35.394	35.435	35.475	35.516	35.556	35.596	35.637	35.677	35.718	850
860	35.718	35.758	35.798	35.839	35.879	35.920	35.960	36.000	36.041	36.081	36.121	860
870	36.121	36.162	36.202	36.242	36.282	36.323	36.363	36.403	36.443	36.484	36.524	870
880	36.524	36.564	36.604	36.644	36.685	36.725	36.765	36.805	36.845	36.885	36.925	880
890	36.925	36.965	37.006	37.046	37.086	37.126	37.166	37.206	37.246	37.286	37.326	890
900	37.326	37.366	37.406	37.446	37.486	37.526	37.566	37.606	37.646	37.686	37.725	900
910	37.725	37.765	37.805	37.845	37.885	37.925	37.965	38.005	38.044	38.084	38.124	910
920	38.124	38.164	38.204	38.243	38.283	38.323	38.363	38.402	38.442	38.482	38.522	920
930	38.522	38.561	38.601	38.641	38.680	38.720	38.760	38.799	38.839	38.878	38.918	930
940	38.918	38.958	38.997	39.037	39.076	39.116	39.155	39.195	39.235	39.274	39.314	940
950	39.314	39.353	39.393	39.432	39.471	39.511	39.550	39.590	39.629	39.669	39.708	950
960	39.708	39.747	39.787	39.826	39.866	39.905	39.944	39.984	40.023	40.062	40.101	960
970	40.101	40.141	40.180	40.219	40.259	40.298	40.337	40.376	40.415	40.455	40.494	970
980	40.494	40.533	40.572	40.611	40.651	40.690	40.729	40.768	40.807	40.846	40.885	980
990	40.885	40.924	40.963	41.002	41.042	41.081	41.120	41.159	41.198	41.237	41.276	990
1000	41.276	41.315	41.354	41.393	41.431	41.470	41.509	41.548	41.587	41.626	41.665	1000
1010	41.665	41.704	41.743	41.781	41.820	41.859	41.898	41.937	41.976	42.014	42.053	1010
1020	42.053	42.092	42.131	42.169	42.208	42.247	42.286	42.324	42.363	42.402	42.440	1020
1030	42.440	42.479	42.518	42.556	42.595	42.633	42.672	42.711	42.749	42.788	42.826	1030
1040	42.826	42.865	42.903	42.942	42.980	43.019	43.057	43.096	43.134	43.173	43.211	1040
1050	43.211	43.250	43.288	43.327	43.365	43.403	43.442	43.480	43.518	43.557	43.595	1050
1060	43.595	43.633	43.672	43.710	43.748	43.787	43.825	43.863	43.901	43.940	43.978	1060
1070	43.978	44.016	44.054	44.092	44.130	44.169	44.207	44.245	44.283	44.321	44.359	1070
1080	44.359	44.397	44.435	44.473	44.512	44.550	44.588	44.626	44.664	44.702	44.740	1080
1090	44.740	44.778	44.816	44.855	44.891	44.929	44.967	45.005	45.043	45.081	45.119	1090
1100	45.119	45.157	45.194	45.232	45.270	45.308	45.346	45.383	45.421	45.459	45.497	1100
1110	45.497	45.534	45.572	45.610	45.647	45.685	45.723	45.760	45.798	45.836	45.873	1110
1120	45.873	45.911	45.948	45.986	46.024	46.061	46.099	46.136	46.174	46.211	46.249	1120
1130	46.249	46.286	46.324	46.361	46.398	46.436	46.473	46.511	46.548	46.585	46.623	1130
1140	46.623	46.660	46.697	46.735	46.772	46.809	46.847	46.884	46.921	46.958	46.995	1140
1150	46.995	47.033	47.070	47.107	47.144	47.181	47.218	47.256	47.293	47.330	47.367	1150
1160	47.367	47.404	47.441	47.478	47.515	47.552	47.589	47.626	47.663	47.700	47.737	1160
1170	47.737	47.774	47.811	47.848	47.884	47.921	47.958	47.995	48.032	48.069	48.105	1170
1180	48.105	48.142	48.179	48.216	48.252	48.289	48.326	48.363	48.399	48.436	48.473	1180
1190	48.473	48.509	48.546	48.582	48.619	48.656	48.692	48.729	48.765	48.802	48.838	1190
1200	48.838	48.875	48.911	48.948	48.984	49.021	49.057	49.093	49.130	49.166	49.202	1200
1210	49.202	49.239	49.275	49.311	49.348	49.384	49.420	49.456	49.493	49.529	49.565	1210
1220	49.565	49.601	49.637	49.674	49.710	49.746	49.782	49.818	49.854	49.890	49.926	1220
1230	49.926	49.962	49.998	50.034	50.070	50.106	50.142	50.178	50.214	50.250	50.286	1230
1240	50.286	50.322	50.358	50.393	50.429	50.465	50.501	50.537	50.572	50.608	50.644	1240
1250	50.644	50.680	50.715	50.751	50.787	50.822	50.858	50.894	50.929	50.965	51.000	1250
1260	51.000	51.036	51.071	51.107	51.142	51.178	51.213	51.249	51.284	51.320	51.355	1260
1270	51.355	51.391	51.426	51.461	51.497	51.532	51.567	51.603	51.638	51.673	51.708	1270
1280	51.708	51.744	51.779	51.814	51.849	51.885	51.920	51.955	51.990	52.025	52.060	1280
1290	52.060	52.095	52.130	52.165	52.200	52.235	52.270	52.305	52.340	52.375	52.410	1290
1300	52.410	52.445	52.480	52.515	52.550	52.585	52.620	52.654	52.689	52.724	52.759	1300
1310	52.759	52.794	52.828	52.863	52.898	52.932	52.967	53.002	53.037	53.071	53.106	1310
1320	53.106	53.140	53.175	53.210	53.244	53.279	53.313	53.348	53.382	53.417	53.451	1320
1330	53.451	53.486	53.520	53.555	53.589	53.623	53.658	53.692	53.727	53.761	53.795	1330
1340	53.795	53.830	53.864	53.898	53.932	53.967	54.001	54.035	54.069	54.104	54.138	1340
1350	54.138	54.172	54.206	54.240	54.274	54.308	54.343	54.377	54.411	54.445	54.479	1350
1360	54.479	54.513	54.547	54.581	54.615	54.649	54.683	54.717	54.751	54.785	54.819	1360
1370	54.819	54.852	54.886									1370

# Thermocouple Reference Tables

Reference Tables  
N.I.S.T Rev. ITS-90

## K-type thermocouple - Temperature in degrees "F" with reference junction at 32°F

°F	-10	-9	-8	-7	-6	-5	-4	-3	-2	-1	0	°F
-450							-6.458	-6.457	-6.457	-6.456	-6.456	-450
-440	-6.456	-6.455	-6.454	-6.454	-6.453	-6.452	-6.451	-6.450	-6.449	-6.448	-6.446	-440
-430	-6.446	-6.445	-6.444	-6.443	-6.441	-6.440	-6.438	-6.436	-6.435	-6.433	-6.431	-430
-420	-6.431	-6.429	-6.427	-6.425	-6.423	-6.421	-6.419	-6.416	-6.414	-6.411	-6.409	-420
-410	-6.409	-6.406	-6.404	-6.401	-6.398	-6.395	-6.392	-6.389	-6.386	-6.383	-6.380	-410
-400	-6.380	-6.377	-6.373	-6.370	-6.366	-6.363	-6.359	-6.355	-6.352	-6.348	-6.344	-400
-390	-6.344	-6.340	-6.336	-6.332	-6.328	-6.323	-6.319	-6.315	-6.310	-6.306	-6.301	-390
-380	-6.301	-6.296	-6.292	-6.287	-6.282	-6.277	-6.272	-6.267	-6.262	-6.257	-6.251	-380
-370	-6.251	-6.246	-6.241	-6.235	-6.230	-6.224	-6.218	-6.213	-6.207	-6.201	-6.195	-370
-360	-6.195	-6.189	-6.183	-6.177	-6.171	-6.165	-6.158	-6.152	-6.146	-6.139	-6.133	-360
-350	-6.133	-6.126	-6.119	-6.113	-6.106	-6.099	-6.092	-6.085	-6.078	-6.071	-6.064	-350
-340	-6.064	-6.057	-6.049	-6.042	-6.035	-6.027	-6.020	-6.012	-6.004	-5.997	-5.989	-340
-330	-5.989	-5.981	-5.973	-5.965	-5.957	-5.949	-5.941	-5.933	-5.925	-5.917	-5.908	-330
-320	-5.908	-5.900	-5.891	-5.883	-5.874	-5.866	-5.857	-5.848	-5.840	-5.831	-5.822	-320
-310	-5.822	-5.813	-5.804	-5.795	-5.786	-5.776	-5.767	-5.758	-5.749	-5.739	-5.730	-310
-300	-5.730	-5.720	-5.711	-5.701	-5.691	-5.682	-5.672	-5.662	-5.652	-5.642	-5.632	-300
-290	-5.632	-5.622	-5.612	-5.602	-5.592	-5.581	-5.571	-5.561	-5.550	-5.540	-5.529	-290
-280	-5.529	-5.519	-5.508	-5.497	-5.487	-5.476	-5.465	-5.454	-5.443	-5.432	-5.421	-280
-270	-5.421	-5.410	-5.399	-5.388	-5.377	-5.365	-5.354	-5.343	-5.331	-5.320	-5.308	-270
-260	-5.308	-5.296	-5.285	-5.273	-5.261	-5.250	-5.238	-5.226	-5.214	-5.202	-5.190	-260
-250	-5.190	-5.178	-5.166	-5.153	-5.141	-5.129	-5.117	-5.104	-5.092	-5.079	-5.067	-250
-240	-5.067	-5.054	-5.042	-5.029	-5.016	-5.003	-4.991	-4.978	-4.965	-4.952	-4.939	-240
-230	-4.939	-4.926	-4.913	-4.900	-4.886	-4.873	-4.860	-4.847	-4.833	-4.820	-4.806	-230
-220	-4.806	-4.793	-4.779	-4.766	-4.752	-4.738	-4.724	-4.711	-4.697	-4.683	-4.669	-220
-210	-4.669	-4.655	-4.641	-4.627	-4.613	-4.599	-4.584	-4.570	-4.556	-4.542	-4.527	-210
-200	-4.527	-4.513	-4.498	-4.484	-4.469	-4.455	-4.440	-4.425	-4.411	-4.396	-4.381	-200
-190	-4.381	-4.366	-4.351	-4.336	-4.321	-4.306	-4.291	-4.276	-4.261	-4.246	-4.231	-190
-180	-4.231	-4.215	-4.200	-4.185	-4.169	-4.154	-4.138	-4.123	-4.107	-4.091	-4.076	-180
-170	-4.076	-4.060	-4.044	-4.029	-4.013	-3.997	-3.981	-3.965	-3.949	-3.933	-3.917	-170
-160	-3.917	-3.901	-3.885	-3.869	-3.852	-3.836	-3.820	-3.803	-3.787	-3.771	-3.754	-160
-150	-3.754	-3.738	-3.721	-3.705	-3.688	-3.671	-3.655	-3.638	-3.621	-3.604	-3.587	-150
-140	-3.587	-3.571	-3.554	-3.537	-3.520	-3.503	-3.486	-3.468	-3.451	-3.434	-3.417	-140
-130	-3.417	-3.400	-3.382	-3.365	-3.348	-3.330	-3.313	-3.295	-3.278	-3.260	-3.243	-130
-120	-3.243	-3.225	-3.207	-3.190	-3.172	-3.154	-3.136	-3.119	-3.101	-3.083	-3.065	-120
-110	-3.065	-3.047	-3.029	-3.011	-2.993	-2.975	-2.957	-2.938	-2.920	-2.902	-2.884	-110
-100	-2.884	-2.865	-2.847	-2.829	-2.810	-2.792	-2.773	-2.755	-2.736	-2.717	-2.699	-100
-90	-2.699	-2.680	-2.662	-2.643	-2.624	-2.605	-2.587	-2.568	-2.549	-2.530	-2.511	-90
-80	-2.511	-2.492	-2.473	-2.454	-2.435	-2.416	-2.397	-2.378	-2.359	-2.339	-2.320	-80
-70	-2.320	-2.301	-2.282	-2.262	-2.243	-2.223	-2.204	-2.185	-2.165	-2.146	-2.126	-70
-60	-2.126	-2.106	-2.087	-2.067	-2.048	-2.028	-2.008	-1.988	-1.969	-1.949	-1.929	-60
-50	-1.929	-1.909	-1.889	-1.869	-1.850	-1.830	-1.810	-1.790	-1.770	-1.749	-1.729	-50
-40	-1.729	-1.709	-1.689	-1.669	-1.649	-1.628	-1.608	-1.588	-1.568	-1.547	-1.527	-40
-30	-1.527	-1.507	-1.486	-1.466	-1.445	-1.425	-1.404	-1.384	-1.363	-1.343	-1.322	-30
-20	-1.322	-1.301	-1.281	-1.260	-1.239	-1.218	-1.198	-1.177	-1.156	-1.135	-1.114	-20
-10	-1.114	-1.094	-1.073	-1.052	-1.031	-1.010	-0.989	-0.968	-0.947	-0.926	-0.905	-10
0	-0.905	-0.883	-0.862	-0.841	-0.820	-0.799	-0.778	-0.756	-0.735	-0.714	-0.692	0
°F	0	1	2	3	4	5	6	7	8	9	10	°F
0	-0.692	-0.671	-0.650	-0.628	-0.607	-0.586	-0.564	-0.543	-0.521	-0.500	-0.478	0
10	-0.478	-0.457	-0.435	-0.413	-0.392	-0.370	-0.349	-0.327	-0.305	-0.284	-0.262	10
20	-0.262	-0.240	-0.218	-0.197	-0.175	-0.153	-0.131	-0.109	-0.088	-0.066	-0.044	20
30	-0.044	-0.022	0.000	0.022	0.044	0.066	0.088	0.110	0.132	0.154	0.176	30
40	0.176	0.198	0.220	0.242	0.264	0.286	0.308	0.330	0.353	0.375	0.397	40
50	0.397	0.419	0.441	0.463	0.486	0.508	0.530	0.552	0.575	0.597	0.619	50
60	0.619	0.642	0.664	0.686	0.709	0.731	0.753	0.776	0.798	0.821	0.843	60
70	0.843	0.865	0.888	0.910	0.933	0.955	0.978	1.000	1.023	1.045	1.068	70
80	1.068	1.090	1.113	1.136	1.158	1.181	1.203	1.226	1.249	1.271	1.294	80
90	1.294	1.316	1.339	1.362	1.384	1.407	1.430	1.453	1.475	1.498	1.521	90
100	1.521	1.543	1.566	1.589	1.612	1.635	1.657	1.680	1.703	1.726	1.749	100
110	1.749	1.771	1.794	1.817	1.840	1.863	1.886	1.909	1.931	1.954	1.977	110
120	1.977	2.000	2.023	2.046	2.069	2.092	2.115	2.138	2.161	2.184	2.207	120
130	2.207	2.230	2.253	2.276	2.298	2.321	2.344	2.367	2.390	2.413	2.436	130
140	2.436	2.459	2.483	2.506	2.529	2.552	2.575	2.598	2.621	2.644	2.667	140
150	2.667	2.690	2.713	2.736	2.759	2.782	2.805	2.828	2.851	2.874	2.897	150
160	2.897	2.920	2.944	2.967	2.990	3.013	3.036	3.059	3.082	3.105	3.128	160
170	3.128	3.151	3.174	3.197	3.220	3.244	3.267	3.290	3.313	3.336	3.359	170
180	3.359	3.382	3.405	3.428	3.451	3.474	3.497	3.520	3.544	3.567	3.590	180
190	3.590	3.613	3.636	3.659	3.682	3.705	3.728	3.751	3.774	3.797	3.820	190
200	3.820	3.843	3.866	3.889	3.912	3.935	3.958	3.981	4.004	4.027	4.050	200
210	4.050	4.073	4.096	4.119	4.142	4.165	4.188	4.211	4.234	4.257	4.280	210
220	4.280	4.303	4.326	4.349	4.372	4.395	4.417	4.440	4.463	4.486	4.509	220
230	4.509	4.532	4.555	4.578	4.601	4.623	4.646	4.669	4.692	4.715	4.738	230
240	4.738	4.760	4.783	4.806	4.829	4.852	4.874	4.897	4.920	4.943	4.965	240
250	4.965	4.988	5.011	5.034	5.056	5.079	5.102	5.124	5.147	5.170	5.192	250
260	5.192	5.215	5.238	5.260	5.283	5.306	5.328	5.351	5.374	5.396	5.419	260
270	5.419	5.441	5.464	5.487	5.509	5.532	5.554	5.577	5.599	5.622	5.644	270
280	5.644	5.667	5.690	5.712	5.735	5.757	5.779	5.802	5.824	5.847	5.869	280
290	5.869	5.892	5.914	5.937	5.959	5.982	6.004	6.026	6.049	6.071	6.094	290
300	6.094	6.116	6.138	6.161	6.183	6.205	6.228	6.250	6.272	6.295	6.317	300
310	6.317	6.339	6.362	6.384	6.406	6.429	6.451	6.473	6.496	6.518	6.540	310
320	6.540	6.562	6.585	6.607	6.629	6.652	6.674	6.696	6.718	6.741	6.763	320
330	6.763	6.785	6.807	6.829	6.852	6.874	6.896	6.918	6.941	6.963	6.985	330
340	6.985	7.007	7.029	7.052	7.074	7.096	7.118	7.140	7.163	7.185	7.207	340

# Thermocouple Reference Tables

## K-type thermocouple - Temperature in degrees "F" with reference junction at 32°F

°F	0	1	2	3	4	5	6	7	8	9	10	°F
350	7.207	7.229	7.251	7.273	7.296	7.318	7.340	7.362	7.384	7.407	7.429	350
360	7.429	7.451	7.473	7.495	7.517	7.540	7.562	7.584	7.606	7.628	7.650	360
370	7.650	7.673	7.695	7.717	7.739	7.761	7.783	7.806	7.828	7.850	7.872	370
380	7.872	7.894	7.917	7.939	7.961	7.983	8.005	8.027	8.050	8.072	8.094	380
390	8.094	8.116	8.138	8.161	8.183	8.205	8.227	8.250	8.272	8.294	8.316	390
400	8.316	8.338	8.361	8.383	8.405	8.427	8.450	8.472	8.494	8.516	8.539	400
410	8.539	8.561	8.583	8.605	8.628	8.650	8.672	8.694	8.717	8.739	8.761	410
420	8.761	8.784	8.806	8.828	8.851	8.873	8.895	8.918	8.940	8.962	8.985	420
430	8.985	9.007	9.029	9.052	9.074	9.096	9.119	9.141	9.163	9.186	9.208	430
440	9.208	9.231	9.253	9.275	9.298	9.320	9.343	9.365	9.388	9.410	9.432	440
450	9.432	9.455	9.477	9.500	9.522	9.545	9.567	9.590	9.612	9.635	9.657	450
460	9.657	9.680	9.702	9.725	9.747	9.770	9.792	9.815	9.837	9.860	9.882	460
470	9.882	9.905	9.927	9.950	9.973	9.995	10.018	10.040	10.063	10.086	10.108	470
480	10.108	10.131	10.153	10.176	10.199	10.221	10.244	10.267	10.289	10.312	10.334	480
490	10.334	10.357	10.380	10.402	10.425	10.448	10.471	10.493	10.516	10.539	10.561	490
500	10.561	10.584	10.607	10.629	10.652	10.675	10.698	10.720	10.743	10.766	10.789	500
510	10.789	10.811	10.834	10.857	10.880	10.903	10.925	10.948	10.971	10.994	11.017	510
520	11.017	11.039	11.062	11.085	11.108	11.131	11.154	11.176	11.199	11.222	11.245	520
530	11.245	11.268	11.291	11.313	11.336	11.359	11.382	11.405	11.428	11.451	11.474	530
540	11.474	11.497	11.519	11.542	11.565	11.588	11.611	11.634	11.657	11.680	11.703	540
550	11.703	11.726	11.749	11.772	11.795	11.818	11.841	11.864	11.887	11.910	11.933	550
560	11.933	11.956	11.978	12.001	12.024	12.047	12.070	12.093	12.116	12.140	12.163	560
570	12.163	12.186	12.209	12.232	12.255	12.278	12.301	12.324	12.347	12.370	12.393	570
580	12.393	12.416	12.439	12.462	12.485	12.508	12.531	12.554	12.577	12.600	12.624	580
590	12.624	12.647	12.670	12.693	12.716	12.739	12.762	12.785	12.808	12.831	12.855	590
600	12.855	12.878	12.901	12.924	12.947	12.970	12.993	13.016	13.040	13.063	13.086	600
610	13.086	13.109	13.132	13.155	13.179	13.202	13.225	13.248	13.271	13.294	13.318	610
620	13.318	13.341	13.364	13.387	13.410	13.433	13.457	13.480	13.503	13.526	13.549	620
630	13.549	13.573	13.596	13.619	13.642	13.665	13.689	13.712	13.735	13.758	13.782	630
640	13.782	13.805	13.828	13.851	13.874	13.898	13.921	13.944	13.967	13.991	14.014	640
650	14.014	14.037	14.060	14.084	14.107	14.130	14.154	14.177	14.200	14.223	14.247	650
660	14.247	14.270	14.293	14.316	14.340	14.363	14.386	14.410	14.433	14.456	14.479	660
670	14.479	14.503	14.526	14.549	14.573	14.596	14.619	14.643	14.666	14.689	14.713	670
680	14.713	14.736	14.759	14.783	14.806	14.829	14.853	14.876	14.899	14.923	14.946	680
690	14.946	14.969	14.993	15.016	15.039	15.063	15.086	15.109	15.133	15.156	15.179	690
700	15.179	15.203	15.226	15.250	15.273	15.296	15.320	15.343	15.366	15.390	15.413	700
710	15.413	15.437	15.460	15.483	15.507	15.530	15.554	15.577	15.600	15.624	15.647	710
720	15.647	15.671	15.694	15.717	15.741	15.764	15.788	15.811	15.834	15.858	15.881	720
730	15.881	15.905	15.928	15.952	15.975	15.998	16.022	16.045	16.069	16.092	16.116	730
740	16.116	16.139	16.163	16.186	16.209	16.233	16.256	16.280	16.303	16.327	16.350	740
750	16.350	16.374	16.397	16.421	16.444	16.468	16.491	16.514	16.538	16.561	16.585	750
760	16.585	16.608	16.632	16.655	16.679	16.702	16.726	16.749	16.773	16.796	16.820	760
770	16.820	16.844	16.867	16.890	16.914	16.937	16.961	16.984	17.008	17.031	17.055	770
780	17.055	17.078	17.102	17.125	17.149	17.173	17.196	17.220	17.243	17.267	17.290	780
790	17.290	17.314	17.337	17.361	17.384	17.408	17.431	17.455	17.478	17.502	17.526	790
800	17.526	17.549	17.573	17.596	17.620	17.643	17.667	17.690	17.714	17.738	17.761	800
810	17.761	17.785	17.808	17.832	17.855	17.879	17.902	17.926	17.950	17.973	17.997	810
820	17.997	18.020	18.044	18.068	18.091	18.115	18.138	18.162	18.185	18.209	18.233	820
830	18.233	18.256	18.280	18.303	18.327	18.351	18.374	18.398	18.421	18.445	18.469	830
840	18.469	18.492	18.516	18.539	18.563	18.587	18.610	18.634	18.657	18.681	18.705	840
850	18.705	18.728	18.752	18.776	18.799	18.823	18.846	18.870	18.894	18.917	18.941	850
860	18.941	18.965	18.988	19.012	19.035	19.059	19.083	19.106	19.130	19.154	19.177	860
870	19.177	19.201	19.224	19.248	19.272	19.295	19.319	19.343	19.366	19.390	19.414	870
880	19.414	19.437	19.461	19.485	19.508	19.532	19.556	19.579	19.603	19.626	19.650	880
890	19.650	19.674	19.697	19.721	19.745	19.768	19.792	19.816	19.839	19.863	19.887	890
900	19.887	19.910	19.934	19.958	19.981	20.005	20.029	20.052	20.076	20.100	20.123	900
910	20.123	20.147	20.171	20.194	20.218	20.242	20.265	20.289	20.313	20.336	20.360	910
920	20.360	20.384	20.407	20.431	20.455	20.479	20.502	20.526	20.550	20.573	20.597	920
930	20.597	20.621	20.644	20.668	20.692	20.715	20.739	20.763	20.786	20.810	20.834	930
940	20.834	20.857	20.881	20.905	20.929	20.952	20.976	21.000	21.023	21.047	21.071	940
950	21.071	21.094	21.118	21.142	21.165	21.189	21.213	21.236	21.260	21.284	21.308	950
960	21.308	21.331	21.355	21.379	21.402	21.426	21.450	21.473	21.497	21.521	21.544	960
970	21.544	21.568	21.592	21.616	21.639	21.663	21.687	21.710	21.734	21.758	21.781	970
980	21.781	21.805	21.829	21.852	21.876	21.900	21.924	21.947	21.971	21.995	22.018	980
990	22.018	22.042	22.066	22.089	22.113	22.137	22.160	22.184	22.208	22.232	22.255	990
1000	22.255	22.279	22.303	22.326	22.350	22.374	22.397	22.421	22.445	22.468	22.492	1000
1010	22.492	22.516	22.540	22.563	22.587	22.611	22.634	22.658	22.682	22.705	22.729	1010
1020	22.729	22.753	22.776	22.800	22.824	22.847	22.871	22.895	22.919	22.942	22.966	1020
1030	22.966	22.990	23.013	23.037	23.061	23.084	23.108	23.132	23.155	23.179	23.203	1030
1040	23.203	23.226	23.250	23.274	23.297	23.321	23.345	23.368	23.392	23.416	23.439	1040
1050	23.439	23.463	23.487	23.510	23.534	23.558	23.581	23.605	23.629	23.652	23.676	1050
1060	23.676	23.700	23.723	23.747	23.771	23.794	23.818	23.842	23.865	23.889	23.913	1060
1070	23.913	23.936	23.960	23.984	24.007	24.031	24.055	24.078	24.102	24.126	24.149	1070
1080	24.149	24.173	24.197	24.220	24.244	24.267	24.291	24.315	24.338	24.362	24.386	1080
1090	24.386	24.409	24.433	24.457	24.480	24.504	24.527	24.551	24.575	24.598	24.622	1090
1100	24.622	24.646	24.669	24.693	24.717	24.740	24.764	24.787	24.811	24.835	24.858	1100
1110	24.858	24.882	24.905	24.929	24.953	24.976	25.000	25.024	25.047	25.071	25.094	1110
1120	25.094	25.118	25.142	25.165	25.189	25.212	25.236	25.260	25.283	25.307	25.330	1120
1130	25.330	25.354	25.377	25.401	25.425	25.448	25.472	25.495	25.519	25.543	25.566	1130
1140	25.566	25.590	25.613	25.637	25.660	25.684	25.708	25.731	25.755	25.778	25.802	1140
1150	25.802	25.825	25.849	25.873	25.896	25.920	25.943	25.967	25.990	26.014	26.037	1150
1160	26.037	26.061	26.084	26.108	26.132	26.155	26.179	26.202	26.226	26.249	26.273	1160
1170	26.273	26.296	26.320	26.343	26.367	26.390	26.414	26.437	26.461	26.484	26.508	1170
1180	26.508	26.532	26.555	26.579	26.602	26.626	26.649	26.673	26.696	26.720	26.743	1180
1190	26.743	26.767	26.790	26.814	26.837	26.861	26.884	26.907	26.931	26.954	26.978	1190

# Thermocouple Reference Tables

Reference Tables  
N.I.S.T Rev. ITS-90

Technical Tables

## K-type thermocouple - Temperature in degrees "F" with reference junction at 32°F

°F	0	1	2	3	4	5	6	7	8	9	10	°F
1200	26.978	27.001	27.025	27.048	27.072	27.095	27.119	27.142	27.166	27.189	27.213	1200
1210	27.213	27.236	27.259	27.283	27.306	27.330	27.353	27.377	27.400	27.424	27.447	1210
1220	27.447	27.471	27.494	27.517	27.541	27.564	27.588	27.611	27.635	27.658	27.681	1220
1230	27.681	27.705	27.728	27.752	27.775	27.798	27.822	27.845	27.869	27.892	27.915	1230
1240	27.915	27.939	27.962	27.986	28.009	28.032	28.056	28.079	28.103	28.126	28.149	1240
1250	28.149	28.173	28.196	28.219	28.243	28.266	28.289	28.313	28.336	28.360	28.383	1250
1260	28.383	28.406	28.430	28.453	28.476	28.500	28.523	28.546	28.570	28.593	28.616	1260
1270	28.616	28.640	28.663	28.686	28.710	28.733	28.756	28.780	28.803	28.826	28.849	1270
1280	28.849	28.873	28.896	28.919	28.943	28.966	28.989	29.013	29.036	29.059	29.082	1280
1290	29.082	29.106	29.129	29.152	29.176	29.199	29.222	29.245	29.269	29.292	29.315	1290
1300	29.315	29.338	29.362	29.385	29.408	29.431	29.455	29.478	29.501	29.524	29.548	1300
1310	29.548	29.571	29.594	29.617	29.640	29.664	29.687	29.710	29.733	29.757	29.780	1310
1320	29.780	29.803	29.826	29.849	29.873	29.896	29.919	29.942	29.965	29.989	30.012	1320
1330	30.012	30.035	30.058	30.081	30.104	30.128	30.151	30.174	30.197	30.220	30.243	1330
1340	30.243	30.267	30.290	30.313	30.336	30.359	30.382	30.405	30.429	30.452	30.475	1340
1350	30.475	30.498	30.521	30.544	30.567	30.590	30.613	30.637	30.660	30.683	30.706	1350
1360	30.706	30.729	30.752	30.775	30.798	30.821	30.844	30.868	30.891	30.914	30.937	1360
1370	30.937	30.960	30.983	31.006	31.029	31.052	31.075	31.098	31.121	31.144	31.167	1370
1380	31.167	31.190	31.213	31.236	31.260	31.283	31.306	31.329	31.352	31.375	31.398	1380
1390	31.398	31.421	31.444	31.467	31.490	31.513	31.536	31.559	31.582	31.605	31.628	1390
1400	31.628	31.651	31.674	31.697	31.720	31.743	31.766	31.789	31.812	31.834	31.857	1400
1410	31.857	31.880	31.903	31.926	31.949	31.972	31.995	32.018	32.041	32.064	32.087	1410
1420	32.087	32.110	32.133	32.156	32.179	32.202	32.224	32.247	32.270	32.293	32.316	1420
1430	32.316	32.339	32.362	32.385	32.408	32.431	32.453	32.476	32.499	32.522	32.545	1430
1440	32.545	32.568	32.591	32.614	32.636	32.659	32.682	32.705	32.728	32.751	32.774	1440
1450	32.774	32.796	32.819	32.842	32.865	32.888	32.911	32.933	32.956	32.979	33.002	1450
1460	33.002	33.025	33.047	33.070	33.093	33.116	33.139	33.161	33.184	33.207	33.230	1460
1470	33.230	33.253	33.275	33.298	33.321	33.344	33.366	33.389	33.412	33.435	33.458	1470
1480	33.458	33.480	33.503	33.526	33.548	33.571	33.594	33.617	33.639	33.662	33.685	1480
1490	33.685	33.708	33.730	33.753	33.776	33.798	33.821	33.844	33.867	33.889	33.912	1490
1500	33.912	33.935	33.957	33.980	34.003	34.025	34.048	34.071	34.093	34.116	34.139	1500
1510	34.139	34.161	34.184	34.207	34.229	34.252	34.275	34.297	34.320	34.343	34.365	1510
1520	34.365	34.388	34.410	34.433	34.456	34.478	34.501	34.524	34.546	34.569	34.591	1520
1530	34.591	34.614	34.637	34.659	34.682	34.704	34.727	34.750	34.772	34.795	34.817	1530
1540	34.817	34.840	34.862	34.885	34.908	34.930	34.953	34.975	34.998	35.020	35.043	1540
1550	35.043	35.065	35.088	35.110	35.133	35.156	35.178	35.201	35.223	35.246	35.268	1550
1560	35.268	35.291	35.313	35.336	35.358	35.381	35.403	35.426	35.448	35.471	35.493	1560
1570	35.493	35.516	35.538	35.560	35.583	35.605	35.628	35.650	35.673	35.695	35.718	1570
1580	35.718	35.740	35.763	35.785	35.807	35.830	35.852	35.875	35.897	35.920	35.942	1580
1590	35.942	35.964	35.987	36.009	36.032	36.054	36.076	36.099	36.121	36.144	36.166	1590
1600	36.166	36.188	36.211	36.233	36.256	36.278	36.300	36.323	36.345	36.367	36.390	1600
1610	36.390	36.412	36.434	36.457	36.479	36.501	36.524	36.546	36.568	36.591	36.613	1610
1620	36.613	36.635	36.658	36.680	36.702	36.725	36.747	36.769	36.792	36.814	36.836	1620
1630	36.836	36.859	36.881	36.903	36.925	36.948	36.970	36.992	37.014	37.037	37.059	1630
1640	37.059	37.081	37.104	37.126	37.148	37.170	37.193	37.215	37.237	37.259	37.281	1640
1650	37.281	37.304	37.326	37.348	37.370	37.393	37.415	37.437	37.459	37.481	37.504	1650
1660	37.504	37.526	37.548	37.570	37.592	37.615	37.637	37.659	37.681	37.703	37.725	1660
1670	37.725	37.748	37.770	37.792	37.814	37.836	37.858	37.881	37.903	37.925	37.947	1670
1680	37.947	37.969	37.991	38.013	38.036	38.058	38.080	38.102	38.124	38.146	38.168	1680
1690	38.168	38.190	38.212	38.235	38.257	38.279	38.301	38.323	38.345	38.367	38.389	1690
1700	38.389	38.411	38.433	38.455	38.477	38.499	38.522	38.544	38.566	38.588	38.610	1700
1710	38.610	38.632	38.654	38.676	38.698	38.720	38.742	38.764	38.786	38.808	38.830	1710
1720	38.830	38.852	38.874	38.896	38.918	38.940	38.962	38.984	39.006	39.028	39.050	1720
1730	39.050	39.072	39.094	39.116	39.138	39.160	39.182	39.204	39.226	39.248	39.270	1730
1740	39.270	39.292	39.314	39.335	39.357	39.379	39.401	39.423	39.445	39.467	39.489	1740
1750	39.489	39.511	39.533	39.555	39.577	39.599	39.620	39.642	39.664	39.686	39.708	1750
1760	39.708	39.730	39.752	39.774	39.796	39.817	39.839	39.861	39.883	39.905	39.927	1760
1770	39.927	39.949	39.970	39.992	40.014	40.036	40.058	40.080	40.101	40.123	40.145	1770
1780	40.145	40.167	40.189	40.211	40.232	40.254	40.276	40.298	40.320	40.341	40.363	1780
1790	40.363	40.385	40.407	40.429	40.450	40.472	40.494	40.516	40.537	40.559	40.581	1790
1800	40.581	40.603	40.624	40.646	40.668	40.690	40.711	40.733	40.755	40.777	40.798	1800
1810	40.798	40.820	40.842	40.864	40.885	40.907	40.929	40.950	40.972	40.994	41.015	1810
1820	41.015	41.037	41.059	41.081	41.102	41.124	41.146	41.167	41.189	41.211	41.232	1820
1830	41.232	41.254	41.276	41.297	41.319	41.341	41.362	41.384	41.405	41.427	41.449	1830
1840	41.449	41.470	41.492	41.514	41.535	41.557	41.578	41.600	41.622	41.643	41.665	1840
1850	41.665	41.686	41.708	41.730	41.751	41.773	41.794	41.816	41.838	41.859	41.881	1850
1860	41.881	41.902	41.924	41.945	41.967	41.988	42.010	42.032	42.053	42.075	42.096	1860
1870	42.096	42.118	42.139	42.161	42.182	42.204	42.225	42.247	42.268	42.290	42.311	1870
1880	42.311	42.333	42.354	42.376	42.397	42.419	42.440	42.462	42.483	42.505	42.526	1880
1890	42.526	42.548	42.569	42.591	42.612	42.633	42.655	42.676	42.698	42.719	42.741	1890
1900	42.741	42.762	42.783	42.805	42.826	42.848	42.869	42.891	42.912	42.933	42.955	1900
1910	42.955	42.976	42.998	43.019	43.040	43.062	43.083	43.104	43.126	43.147	43.169	1910
1920	43.169	43.190	43.211	43.233	43.254	43.275	43.297	43.318	43.339	43.361	43.382	1920
1930	43.382	43.403	43.425	43.446	43.467	43.489	43.510	43.531	43.552	43.574	43.595	1930
1940	43.595	43.616	43.638	43.659	43.680	43.701	43.723	43.744	43.765	43.787	43.808	1940
1950	43.808	43.829	43.850	43.872	43.893	43.914	43.935	43.957	43.978	43.999	44.020	1950
1960	44.020	44.041	44.063	44.084	44.105	44.126	44.147	44.169	44.190	44.211	44.232	1960
1970	44.232	44.253	44.275	44.296	44.317	44.338	44.359	44.380	44.402	44.423	44.444	1970
1980	44.444	44.465	44.486	44.507	44.528	44.550	44.571	44.592	44.613	44.634	44.655	1980
1990	44.655	44.676	44.697	44.719	44.740	44.761	44.782	44.803	44.824	44.845	44.866	1990
2000	44.866	44.887	44.908	44.929	44.950	44.971	44.992	45.014	45.035	45.056	45.077	2000
2010	45.077	45.098	45.119	45.140	45.161	45.182	45.203	45.224	45.245	45.266	45.287	2010
2020	45.287	45.308	45.329	45.350	45.371	45.392	45.413	45.434	45.455	45.476	45.497	2020
2030	4											



## K-type thermocouple - Temperature in degrees "F" with reference junction at 32°F

°F	0	1	2	3	4	5	6	7	8	9	10	°F
2050	45.915	45.936	45.957	45.978	45.999	46.019	46.040	46.061	46.082	46.103	46.124	2050
2060	46.124	46.145	46.165	46.186	46.207	46.228	46.249	46.269	46.290	46.311	46.332	2060
2070	46.332	46.353	46.373	46.394	46.415	46.436	46.457	46.477	46.498	46.519	46.540	2070
2080	46.540	46.560	46.581	46.602	46.623	46.643	46.664	46.685	46.706	46.726	46.747	2080
2090	46.747	46.768	46.789	46.809	46.830	46.851	46.871	46.892	46.913	46.933	46.954	2090
2100	46.954	46.975	46.995	47.016	47.037	47.057	47.078	47.099	47.119	47.140	47.161	2100
2110	47.161	47.181	47.202	47.223	47.243	47.264	47.284	47.305	47.326	47.346	47.367	2110
2120	47.367	47.387	47.408	47.429	47.449	47.470	47.490	47.511	47.531	47.552	47.573	2120
2130	47.573	47.593	47.614	47.634	47.655	47.675	47.696	47.716	47.737	47.757	47.778	2130
2140	47.778	47.798	47.819	47.839	47.860	47.880	47.901	47.921	47.942	47.962	47.983	2140
2150	47.983	48.003	48.024	48.044	48.065	48.085	48.105	48.126	48.146	48.167	48.187	2150
2160	48.187	48.208	48.228	48.248	48.269	48.289	48.310	48.330	48.350	48.371	48.391	2160
2170	48.391	48.411	48.432	48.452	48.473	48.493	48.513	48.534	48.554	48.574	48.595	2170
2180	48.595	48.615	48.635	48.656	48.676	48.696	48.717	48.737	48.757	48.777	48.798	2180
2190	48.798	48.818	48.838	48.859	48.879	48.899	48.919	48.940	48.960	48.980	49.000	2190
2200	49.000	49.021	49.041	49.061	49.081	49.101	49.122	49.142	49.162	49.182	49.202	2200
2210	49.202	49.223	49.243	49.263	49.283	49.303	49.323	49.344	49.364	49.384	49.404	2210
2220	49.404	49.424	49.444	49.465	49.485	49.505	49.525	49.545	49.565	49.585	49.605	2220
2230	49.605	49.625	49.645	49.666	49.686	49.706	49.726	49.746	49.766	49.786	49.806	2230
2240	49.806	49.826	49.846	49.866	49.886	49.906	49.926	49.946	49.966	49.986	50.006	2240
2250	50.006	50.026	50.046	50.066	50.086	50.106	50.126	50.146	50.166	50.186	50.206	2250
2260	50.206	50.226	50.246	50.266	50.286	50.306	50.326	50.346	50.366	50.385	50.405	2260
2270	50.405	50.425	50.445	50.465	50.485	50.505	50.525	50.545	50.564	50.584	50.604	2270
2280	50.604	50.624	50.644	50.664	50.684	50.703	50.723	50.743	50.763	50.783	50.802	2280
2290	50.802	50.822	50.842	50.862	50.882	50.901	50.921	50.941	50.961	50.981	51.000	2290
2300	51.000	51.020	51.040	51.060	51.079	51.099	51.119	51.139	51.158	51.178	51.198	2300
2310	51.198	51.217	51.237	51.257	51.276	51.296	51.316	51.336	51.355	51.375	51.395	2310
2320	51.395	51.414	51.434	51.453	51.473	51.493	51.512	51.532	51.552	51.571	51.591	2320
2330	51.591	51.611	51.630	51.650	51.669	51.689	51.708	51.728	51.748	51.767	51.787	2330
2340	51.787	51.806	51.826	51.845	51.865	51.885	51.904	51.924	51.943	51.963	51.982	2340
2350	51.982	52.002	52.021	52.041	52.060	52.080	52.099	52.119	52.138	52.158	52.177	2350
2360	52.177	52.197	52.216	52.235	52.255	52.274	52.294	52.313	52.333	52.352	52.371	2360
2370	52.371	52.391	52.410	52.430	52.449	52.468	52.488	52.507	52.527	52.546	52.565	2370
2380	52.565	52.585	52.604	52.623	52.643	52.662	52.681	52.701	52.720	52.739	52.759	2380
2390	52.759	52.778	52.797	52.817	52.836	52.855	52.875	52.894	52.913	52.932	52.952	2390
2400	52.952	52.971	52.990	53.010	53.029	53.048	53.067	53.087	53.106	53.125	53.144	2400
2410	53.144	53.163	53.183	53.202	53.221	53.240	53.260	53.279	53.298	53.317	53.336	2410
2420	53.336	53.355	53.375	53.394	53.413	53.432	53.451	53.470	53.490	53.509	53.528	2420
2430	53.528	53.547	53.566	53.585	53.604	53.623	53.643	53.662	53.681	53.700	53.719	2430
2440	53.719	53.738	53.757	53.776	53.795	53.814	53.833	53.852	53.871	53.890	53.910	2440
2450	53.910	53.929	53.948	53.967	53.986	54.005	54.024	54.043	54.062	54.081	54.100	2450
2460	54.100	54.119	54.138	54.157	54.176	54.195	54.214	54.233	54.252	54.271	54.289	2460
2470	54.289	54.308	54.327	54.346	54.365	54.384	54.403	54.422	54.441	54.460	54.479	2470
2480	54.479	54.498	54.517	54.536	54.554	54.573	54.592	54.611	54.630	54.649	54.668	2480
2490	54.668	54.687	54.705	54.724	54.743	54.762	54.781	54.800	54.819	54.837	54.856	2490
2500	54.856	54.875	54.894									

## Resistance Values of HANNA Thermistor Sensors

### HI 765 Series

The following table shows various ambient temperatures and the corresponding resistance values of our HI765 sensor series in the -50.0 to +170.0°C range

Ambient Temperature (°C)	Resistance (ohm)	Ambient Temperature (°C)	Resistance (ohm)
-50.0	537.2	60.0	1275.3
-40.0	588.2	70.0	1361.9
-30.0	641.9	80.0	1450.2
-20.0	699.5	90.0	1542.0
-10.0	760.9	100.0	1637.2
0.0	825.0	110.0	1734.9
10.0	891.9	120.0	1835.9
20.0	962.4	130.0	1939.4
25.0	999.1	140.0	2045.2
30.0	1036.7	150.0	2154.3
40.0	1112.6	160.0	2267.5
50.0	1193.1	170.0	2380.2

### HI 762 Series

The following table shows various ambient temperatures and the corresponding resistance values of our HI762 sensor series in the -50.0 to +140.0°C range

Ambient Temperature (°C)	Resistance (ohm)	Ambient Temperature (°C)	Resistance (ohm)
-50.0	670100	50.0	3603
-40.0	336500	60.0	2488
-30.0	177000	70.0	1752
-20.0	97070	80.0	1258
-10.0	55330	90.0	917.7
0.0	32650	100.0	680.0
10.0	19900	110.0	511.2
20.0	12490	120.0	389.3
25.0	10000	130.0	300.9
30.0	8057	140.0	234.8
40.0	5327		

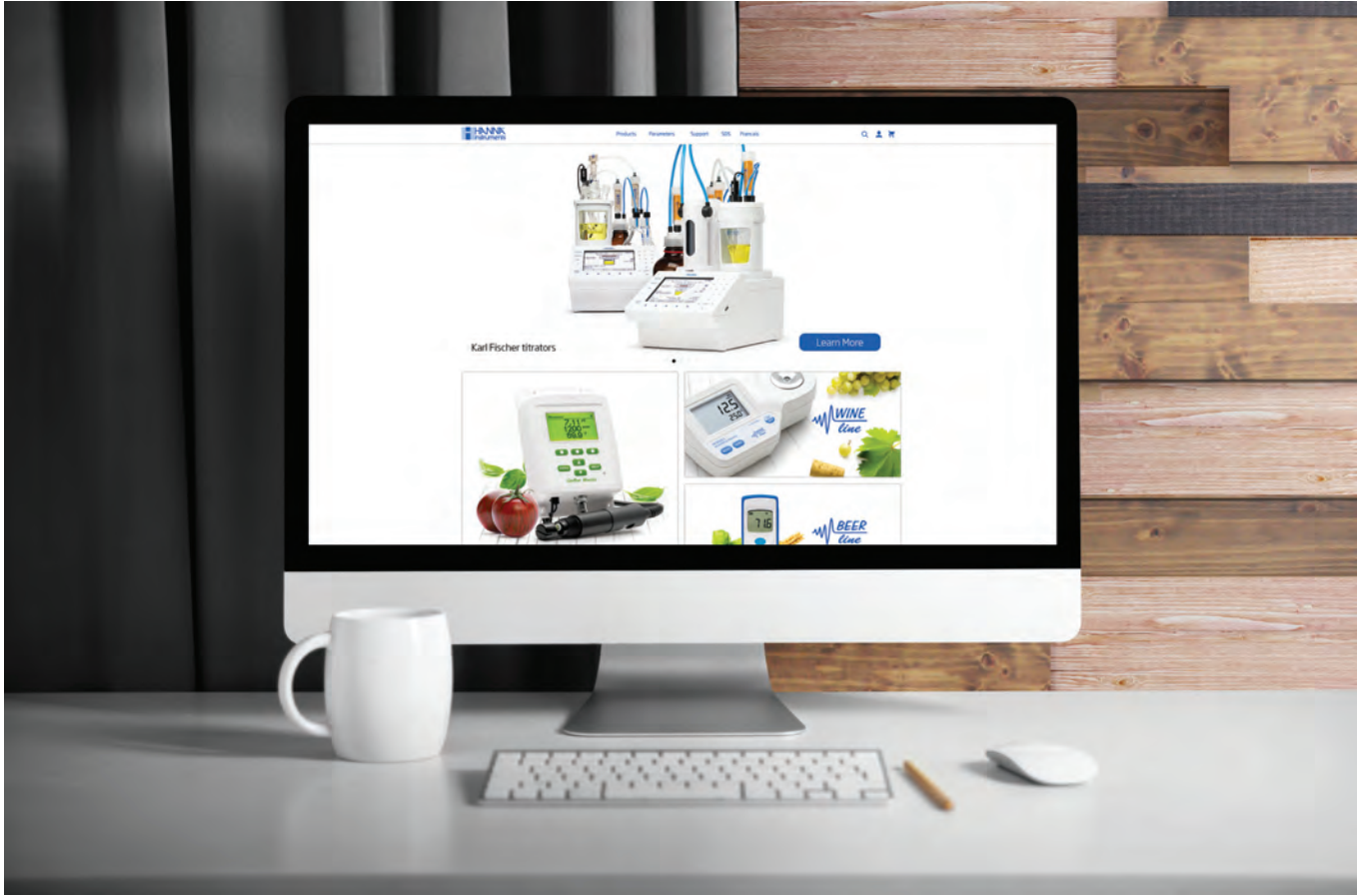

### Quick access to our entire catalog.

Visit [hannainst.com](http://hannainst.com). There you can search for products, look up local office contacts, consult our knowledgebase and download instruction manuals, MSDS and brochures.

Find Your Hanna

For Educators and Students



[hannainst.com](http://hannainst.com)

[backpacklab.com](http://backpacklab.com)

<b>BL1.5</b> ..... 15.105	<b>BL931700</b> ..... 15.81	<b>edge®DO</b> ..... 6.20	<b>HALO2</b> ..... 2.40
BL1.5-1..... 15.105	BL931700-0..... 15.81	edge®DO (HI2004-01)..... 6.20	HALO2 (HI9810302)..... 2.45
BL1.5-2..... 15.105	BL931700-1..... 15.81	edge®DO (HI2004-02)..... 6.20	HALO2 (HI9810312)..... 2.49
<b>BL10</b> ..... 15.105	<b>BL932700</b> ..... 15.83	<b>edge®EC</b> ..... 5.22	HALO2 (HI9810322)..... 2.53
BL10-1..... 15.105	BL932700-0..... 15.83	edge®EC (HI2003-01)..... 5.22	HALO2 (HI9810332)..... 2.50
BL10-2..... 15.105	BL932700-1..... 15.83	edge®EC (HI2003-02)..... 5.22	HALO2 (HI9810342)..... 2.52
<b>BL100</b> ..... 15.42	<b>BL981411</b> ..... 15.80	<b>edge®pH</b> ..... 2.30	HALO2 (HI9810352)..... 2.51
BL100-00..... 15.42	BL981411-0..... 15.80	edge®pH (HI2002-01)..... 2.30	HALO2 (HI9810362)..... 2.54
BL100-10..... 15.42	BL981411-1..... 15.80	edge®pH (HI2002-02)..... 2.30	HALO2 (HI9810372)..... 2.47
BL100-20..... 15.42	<b>BL982411</b> ..... 15.82	<b>FC098</b> ..... 2.165	HALO2 (HI9810382)..... 2.57
<b>BL100-300</b> ..... 15.43, 15.47	BL982411-0..... 15.82	<b>FC099</b> ..... 2.165	HALO2 (HI9810392)..... 2.55
<b>BL100-302</b> ..... 15.35, 15.39, 15.43, 15.47	BL982411-1..... 15.82	<b>FC100B</b> ..... 2.164	HALO2 (HI9810402)..... 2.42
<b>BL100-400</b> ..... 15.35, 15.39, 15.43, 15.47	<b>BL983313</b> ..... 15.85	<b>FC1013</b> ..... 2.93, 2.164	HALO2 (HI9810412)..... 2.43
<b>BL100-421</b> ..... 15.35, 15.39, 15.43, 15.47	BL983313-0..... 15.85	<b>FC10483</b> ..... 2.113, 2.135, 2.166	HALO2 (HI9810422)..... 2.44
<b>BL101</b> ..... 15.46	BL983313-1..... 15.85	<b>FC200B</b> ..... 2.164	HALO2 (HI9810432)..... 2.46
BL101-00..... 15.46	BL983313-2..... 15.85	<b>FC200D</b> ..... 2.164	HALO2 (HI9810442)..... 2.48
BL101-10..... 15.46	<b>BL983314</b> ..... 15.91	<b>FC2020</b> ..... 2.162	<b>HI1001</b> ..... 15.84, 15.120
BL101-20..... 15.46	BL983314-0..... 15.91	<b>FC2022</b> ..... 2.65	<b>HI1002/3</b> ..... 15.121
<b>BL120</b> ..... 15.26	BL983314-1..... 15.91	<b>FC2023</b> ..... 2.89, 2.166	<b>HI1002/5</b> ..... 15.121
BL120-10..... 15.30	<b>BL983315</b> ..... 15.87	<b>FC2053</b> ..... 2.166	<b>HI1003/3</b> ..... 15.121
BL120-20..... 15.30	BL983315-0..... 15.87	<b>FC2100</b> ..... 2.162	<b>HI1003/5</b> ..... 15.121
<b>BL120-150</b> ..... 15.25, 15.31	BL983315-1..... 15.87	<b>FC210B</b> ..... 2.164	<b>HI1005</b> ..... 15.120
<b>BL120-163</b> ..... 15.25, 15.31	BL983315-2..... 15.87	<b>FC2133</b> ..... 2.101, 2.167	<b>HI10053</b> ..... 15.43
<b>BL120-175</b> ..... 15.25, 15.31	<b>BL983317</b> ..... 15.86	<b>FC2142</b> ..... 2.69	<b>HI1006-18 Series</b> ..... 15.58
<b>BL120-200</b> ..... 15.25, 15.31, 15.35, 15.39	BL983317-0..... 15.86	<b>FC2143</b> ..... 2.109, 2.133, 2.166	<b>HI1006-1805</b> ..... 15.59
<b>BL120-201</b> ..... 15.25, 15.31, 15.35, 15.39	BL983317-1..... 15.86	<b>FC2153</b> ..... 2.169	<b>HI1006-38 Series</b> ..... 15.58
<b>BL120-202</b> ..... 15.25, 15.31, 15.35, 15.39	BL983317-2..... 15.86	<b>FC220B</b> ..... 2.165	<b>HI1006-48 Series</b> ..... 15.58
<b>BL120-203</b> ..... 15.25, 15.31	<b>BL983318</b> ..... 15.88	<b>FC230B</b> ..... 2.165	<b>HI10063</b> ..... 15.35
<b>BL120-204</b> ..... 15.25, 15.31	BL983318-0..... 15.88	<b>FC2320</b> ..... 2.162	<b>HI101</b> ..... 15.127
<b>BL120-205</b> ..... 15.25, 15.31	BL983318-1..... 15.88	<b>FC2323</b> ..... 2.97, 2.167	<b>HI101/3</b> ..... 15.127
<b>BL120-250</b> ..... 15.25, 15.31, 15.35, 15.39	<b>BL983319</b> ..... 15.87	<b>FC240B</b> ..... 2.165	<b>HI101/5</b> ..... 15.127
<b>BL120-263</b> ..... 15.25, 15.31, 15.35, 15.39	BL983319-0..... 15.87	<b>FC2423</b> ..... 2.105, 2.167	<b>HI1016-18 Series</b> ..... 15.58
<b>BL120-275</b> ..... 15.25, 15.31, 15.35, 15.39	BL983319-1..... 15.87	<b>FC2423-1</b> ..... 2.167	<b>HI1016-38 Series</b> ..... 15.58
<b>BL120-300</b> ..... 15.25, 15.31	BL983319-2..... 15.87	<b>FC260B</b> ..... 2.171	<b>HI1016-48 Series</b> ..... 15.58
<b>BL120-301</b> ..... 15.25, 15.31, 15.35, 15.39	<b>BL983320</b> ..... 15.85	<b>FC300B</b> ..... 3.27	<b>HI102</b> ..... 15.127
<b>BL120-302</b> ..... 15.25, 15.31	BL983320-0..... 15.85	<b>FC301B</b> ..... 3.25	<b>HI1026-1803</b> ..... 15.60
<b>BL120-400</b> ..... 15.25, 15.31	BL983320-1..... 15.85	<b>FC400B</b> ..... 2.165	<b>HI1036-1802</b> ..... 15.22, 15.29, 15.127
<b>BL120-401</b> ..... 15.25, 15.31, 15.35, 15.39	BL983320-2..... 15.85	<b>FC762N2</b> ..... 14.27, 14.29	<b>HI1036-1805</b> ..... 15.127
<b>BL120-402</b> ..... 15.25, 15.31	<b>BL983321</b> ..... 15.87	<b>FC762PW</b> ..... 14.29	<b>HI1036-1810</b> ..... 15.127
<b>BL120-410</b> ..... 15.25, 15.31, 15.35, 15.39	BL983321-0..... 15.87	<b>FC762W1/2</b> ..... 14.29	<b>HI1036-1815</b> ..... 15.127
<b>BL120-411</b> ..... 15.25, 15.31	BL983321-1..... 15.87	<b>FC766C1</b> ..... 14.35	<b>HI1036-1820</b> ..... 15.127
<b>BL120-450</b> ..... 15.25, 15.31, 15.35, 15.39	<b>BL983322</b> ..... 15.85	<b>FC766EX</b> ..... 14.36	<b>HI10430</b> ..... 2.161
<b>BL120-463</b> ..... 15.25, 15.31, 15.35, 15.39	BL983322-0..... 15.85	<b>FC766F/1</b> ..... 14.37	<b>HI1043B</b> ..... 2.154
<b>BL120-475</b> ..... 15.25, 15.31, 15.35, 15.39	BL983322-1..... 15.85	<b>FC766F/10</b> ..... 14.37	<b>HI1043P</b> ..... 2.154
<b>BL120-500</b> ..... 15.25, 15.31	BL983322-2..... 15.85	<b>FC766F/20</b> ..... 14.37	<b>HI10480</b> ..... 2.162
<b>BL120-501</b> ..... 15.25, 15.31	<b>BL983324</b> ..... 15.89	<b>FC766F/3</b> ..... 14.37	<b>HI10482</b> ..... 2.67
<b>BL120-550</b> ..... 15.25, 15.31	BL983324-0..... 15.89	<b>FC766F/5</b> ..... 14.37	<b>HI1048B</b> ..... 2.166
<b>BL120-563</b> ..... 15.25, 15.31	BL983324-1..... 15.89	<b>FC766HD</b> ..... 14.36	<b>HI1048B/50</b> ..... 2.166
<b>BL120-575</b> ..... 15.25, 15.31	<b>BL983327</b> ..... 15.86	<b>FC766PC1</b> ..... 14.36	<b>HI1048P</b> ..... 2.166
<b>BL120-601</b> ..... 15.25, 15.31	BL983327-1..... 15.86	<b>FC766PW</b> ..... 14.35	<b>HI1048Y</b> ..... 2.166
<b>BL120-602</b> ..... 15.25, 15.31	BL983327-2..... 15.86	<b>FC766T/1</b> ..... 14.38	<b>HI1049B</b> ..... 2.168
<b>BL120-603</b> ..... 15.25, 15.31	<b>BL983329</b> ..... 15.87	<b>FC766T/10</b> ..... 14.38	<b>HI10530</b> ..... 2.161
<b>BL120-604</b> ..... 15.25, 15.31	BL983329-0..... 15.87	<b>FC766T/3</b> ..... 14.38	<b>HI10533</b> ..... 2.154
<b>BL120-605</b> ..... 15.25, 15.31	BL983329-1..... 15.87	<b>FC766T/5</b> ..... 14.38	<b>HI1053B</b> ..... 2.154
<b>BL120-901</b> ..... 15.25, 15.31	BL983329-2..... 15.87	<b>FC766T/7</b> ..... 14.38	<b>HI1053P</b> ..... 2.154
<b>BL120-902</b> ..... 15.25, 15.31	<b>Checker®Plus</b> ..... 1.20	<b>FC766TZ-0</b> ..... 14.38	<b>HI10832</b> ..... 2.63
<b>BL120-903</b> ..... 15.25, 15.31	<b>Checkfridge C (HI147-00)</b> ..... 1.67	<b>FC766TZ/120</b> ..... 14.38	<b>HI1083B</b> ..... 2.154
<b>BL121</b> ..... 15.26	<b>Checkfridge F (HI147-01)</b> ..... 1.67	<b>FC766TZ/30</b> ..... 14.38	<b>HI1083P</b> ..... 2.154
BL121-10..... 15.30	<b>Checktemp (HI98501)</b> ..... 1.50	<b>FC766TZ/60</b> ..... 14.38	<b>HI1090B/5</b> ..... 15.123
BL121-20..... 15.30	<b>Checktemp®1 (HI98509)</b> ..... 1.51	<b>FC766TZ/2/1</b> ..... 14.38	<b>HI1090T</b> ..... 15.125
<b>BL122</b> ..... 15.16	<b>Checktemp®4</b> ..... 1.49	<b>FC766W1/1</b> ..... 14.37	<b>HI1093B</b> ..... 2.155
BL122-10..... 15.24	Checktemp®4 (HI151-000)..... 1.49	<b>FC766W1/10</b> ..... 14.37	<b>HI1093P</b> ..... 2.155
BL122-20..... 15.24	Checktemp®4 (HI151-1)..... 1.49	<b>FC766W1/3</b> ..... 14.37	<b>HI1102 (HALO®)</b> ..... 2.61
<b>BL123</b> ..... 15.16	Checktemp®4 (HI151-100)..... 1.49	<b>FC766W1/5</b> ..... 14.37	<b>HI1103</b> ..... 2.156
BL123-10..... 15.24	Checktemp®4 (HI151-2)..... 1.49	<b>FC766Y/1</b> ..... 14.37	<b>HI1108</b> ..... 2.156
BL123-20..... 15.24	Checktemp®4 (HI151-200)..... 1.49	<b>FC766Y/10</b> ..... 14.37	<b>HI1126-1805</b> ..... 15.61
<b>BL123-70</b> ..... 15.25, 15.31	Checktemp®4 (HI151-3)..... 1.49	<b>FC766Y/2</b> ..... 14.37	<b>HI1130</b> ..... 2.161
<b>BL123-70-30</b> ..... 15.25, 15.31	Checktemp®4 (HI151-300)..... 1.49	<b>FC766Y/3</b> ..... 14.37	<b>HI11311</b> ..... 2.161
<b>BL15</b> ..... 15.105	Checktemp®4 (HI151-4)..... 1.49	<b>FC766Y/5</b> ..... 14.37	<b>HI11312 (HALO®)</b> ..... 2.60
BL15-1..... 15.105	Checktemp®4 (HI151-400)..... 1.49	<b>FC766Y/8</b> ..... 14.37	<b>HI11313</b> ..... 2.155
BL15-2..... 15.105	Checktemp®4 (HI151-5)..... 1.49	<b>FC767C1</b> ..... 14.39	<b>HI1131B</b> ..... 2.155
<b>BL20</b> ..... 15.105	Checktemp®4 (HI151-500)..... 1.49	<b>FC767F/1</b> ..... 14.41	<b>HI1131P</b> ..... 2.155
BL20-1..... 15.105	Checktemp®4 (HI151)..... 1.49	<b>FC767PW</b> ..... 14.39	<b>HI1131Y</b> ..... 2.155
BL20-2..... 15.105	<b>Checktemp Dip (HI98539)</b> ..... 1.52	<b>FC767W1/1</b> ..... 14.40	<b>HI1143B</b> ..... 2.156
<b>BL3</b> ..... 15.105	<b>Combo (HI98129)</b> ..... 1.8	<b>FC767Y/1</b> ..... 14.41	<b>HI1144B</b> ..... 2.157
BL3-1..... 15.105	<b>Combo (HI98130)</b> ..... 1.8	<b>FC911B</b> ..... 2.166	<b>HI1151B</b> ..... 2.155
BL3-2..... 15.105	<b>DiST 1</b> ..... 1.44	<b>Flat Tip pH Electrodes</b> ..... 15.114	<b>HI1190T</b> ..... 15.125
<b>BL5</b> ..... 15.105	<b>DiST 2</b> ..... 1.44	<b>HALO®</b> ..... 2.58	<b>HI1191T</b> ..... 15.125
BL5-1..... 15.105	<b>DiST 3</b> ..... 1.44	HALO® (FC2022)..... 2.65	<b>HI1192T</b> ..... 15.125
BL5-2..... 15.105	<b>DiST 4</b> ..... 1.44	HALO® (FC2142)..... 2.69	<b>HI1210B/5</b> ..... 15.124
<b>BL7</b> ..... 15.105	<b>DiST 5 (HI98311)</b> ..... 1.41	HALO® (HI10482)..... 2.67	<b>HI1210T</b> ..... 15.126
BL7-1..... 15.105	<b>DiST 6 (HI98312)</b> ..... 1.41	HALO® (HI10532)..... 2.73	<b>HI1211T</b> ..... 15.126
BL7-2..... 15.105	<b>DiST 9 (HI98326)</b> ..... 1.39	HALO® (HI10832)..... 2.63	<b>HI1217D</b> ..... 2.159
<b>BL7916</b> ..... 15.98	<b>edge® (HI2020)</b> ..... 2.26	HALO® (HI11102)..... 2.61	<b>HI122</b> ..... 2.24
BL7916-1..... 15.98	<b>edge® (HI2030)</b> ..... 5.18	HALO® (HI11312)..... 2.60	<b>HI122-01</b> ..... 2.25
BL7916-2..... 15.98	<b>edge® (HI2040)</b> ..... 6.16	HALO® (HI12302)..... 2.64	<b>HI122-02</b> ..... 2.25
<b>BL7917</b> ..... 15.99	<b>edge®blu (HI2202)</b> ..... 2.34	HALO® (HI12922)..... 2.71	<b>HI12300</b> ..... 2.163
BL7917-1..... 15.99		HALO® (HI13302)..... 2.62	<b>HI12301</b> ..... 2.163
BL7917-2..... 15.99		HALO® (HI14142)..... 2.72	<b>HI12302</b> ..... 2.64
			<b>HI12303</b> ..... 2.156
			<b>HI12308</b> ..... 2.156

HI1230Y.....	2.156	HI181.....	8.7	HI302N.....	8.4	HI3835-100.....	9.45, 9.46
HI1270.....	1.68	HI181-1.....	8.7	HI302N-1.....	8.4	HI3838.....	9.19
HI1271.....	1.69	HI181-2.....	8.7	HI302N-2.....	8.4	HI3838-100.....	9.45
HI1280.....	1.69	HI181A-1.....	8.7	HI304N.....	8.5	HI3840.....	9.21
HI1283.....	15.101	HI181A-2.....	8.7	HI304N-1.....	8.5	HI3841.....	9.21
HI1285.....	7.55	HI181C-1.....	8.7	HI304N-2.....	8.5	HI3842.....	9.21
HI1285-51.....	7.57, 7.58	HI181C-2.....	8.7	HI3090T.....	15.126	HI3843.....	9.22
HI1285-61.....	7.57, 7.58	HI181E-1.....	8.7	HI310N.....	8.4	HI3843-100.....	9.45
HI1285-7.....	7.53, 7.58	HI181E-2.....	8.7	HI310N-1.....	8.4	HI38434.....	9.22
HI1285-8.....	1.60, 1.70	HI181F-1.....	8.7	HI310N-2.....	8.4	HI3844.....	9.22
HI1285-9.....	1.56, 1.70	HI181F-2.....	8.7	HI3131B.....	2.158	HI3844-100.....	9.45
HI1286.....	1.70	HI181I-1.....	8.7	HI3133B.....	2.171	HI38444.....	9.22
HI1288.....	7.51	HI181I-2.....	8.7	HI3148B.....	2.167	HI3846.....	9.18
HI12883.....	7.58	HI181J-1.....	8.7	HI3148B/50.....	2.167	HI3846-100.....	9.45
HI1290.....	1.69	HI181J-2.....	8.7	HI3149B.....	2.158	HI3847.....	9.18
HI1291D.....	2.159	HI181K-1.....	8.7	HI3190T.....	15.126	HI3847-100.....	9.45
HI12922.....	2.71	HI181K-2.....	8.7	HI3210B/5.....	15.124	HI3859.....	9.19
HI12923.....	2.117, 2.168	HI181L-1.....	8.7	HI3211T.....	15.126	HI3859-025.....	9.45
HI1293.....	1.70	HI181L-2.....	8.7	HI3230B.....	2.160	HI3873.....	9.26
HI12943.....	2.169, 7.53	HI181M-1.....	8.7	HI324N-1.....	8.5	HI3873-100.....	9.45, 9.46
HI1295.....	1.69	HI181M-2.....	8.7	HI324N-2.....	8.5	HI3874.....	9.25
HI12963.....	2.169	HI181W-1.....	8.7	HI3314.....	15.91	HI3874-100.....	9.44, 9.45, 9.46
HI12973.....	2.169	HI181W-2.....	8.7	HI36180.....	2.163	HI3875.....	9.15
HI13302.....	2.62	HI190.....	8.3	HI36183.....	2.158	HI3875-100.....	9.45
HI1330B.....	2.157	HI190M-0.....	8.3	HI3618D.....	2.158	HI3887.....	9.36
HI1330P.....	2.157	HI190M-1.....	8.3	HI36200.....	2.163	HI3890.....	9.20
HI1331B.....	2.156	HI190M-2.....	8.3	HI36203.....	2.160	HI38904.....	9.20
HI1332B.....	2.160	HI2001.....	15.84, 15.120	HI38000.....	9.29	HI3895.....	9.31
HI1332D.....	2.160	HI2002 (edge®pH).....	2.30	HI38000-10.....	9.46	HI3895-010.....	9.31, 9.45
HI1332P.....	2.160	HI2002-01 (edge®pH).....	2.30	HI38001.....	9.30	HI3896.....	9.31
HI1343B.....	2.157	HI2002-02 (edge®pH).....	2.30	HI38001-10.....	9.46	HI3896-025.....	9.31, 9.45
HI1413B.....	2.168	HI2002-03 (edge®pH).....	2.33	HI38017.....	9.16	HI3896BP.....	9.41
HI14140.....	2.162	HI2002/3.....	15.121	HI38017-200.....	9.46	HI3897.....	9.8
HI14142.....	2.72	HI2002/5.....	15.121	HI38018.....	9.15	HI3897-010.....	9.45
HI14143.....	2.168	HI2003 (edger®EC).....	5.22	HI38018-200.....	9.46	HI3899B.....	9.43
HI14143/50.....	2.168	HI2003-01 (edge®EC).....	5.22	HI38020.....	9.16	HI4000-00.....	3.29
HI144.....	14.44	HI2003-02 (edge®EC).....	5.22	HI38020-200.....	9.46	HI4000-47.....	3.28
HI144-10.....	14.44	HI2003-03 (edge®EC).....	5.25	HI38023.....	9.17	HI4000-50.....	3.30
HI144002.....	14.44	HI2003/3.....	15.121	HI38023-100.....	9.46	HI4000-51.....	3.30
HI145-00.....	1.53	HI2003/5.....	15.121	HI38033.....	9.20	HI4000-52.....	3.30
HI145-01.....	1.53	HI2004 (edge®DO).....	6.20	HI38033-100.....	9.46	HI4000-54.....	3.30
HI145-20.....	1.53	HI2004-01 (edge®DO).....	6.20	HI38039.....	9.23	HI4000-70.....	3.30
HI145-30.....	1.53	HI2004-02 (edge®DO).....	6.20	HI38039-100.....	9.46	HI4001-00.....	3.29
HI146-00 (Pronto).....	1.66	HI2004-03.....	6.23	HI38040.....	9.24	HI4001-01.....	3.28
HI147-00.....	1.67	HI2004-18 Series.....	15.57	HI38040-100.....	9.46	HI4001-02.....	3.28
HI147-01.....	1.67	HI2004-1805.....	15.57	HI38041.....	9.24	HI4001-03.....	3.28
HI148.....	14.6, 14.42	HI2004-28 Series.....	15.57	HI38041-100.....	9.46	HI4001-40.....	3.28
HI148.....	14.43	HI2008.....	15.122	HI38050.....	9.25	HI4001-45.....	3.28
HI148-1.....	14.43	HI20083.....	15.46	HI38050-200.....	9.46	HI4001-51.....	3.30
HI148-2.....	14.43	HI200M-1.....	8.3	HI38054.....	9.27	HI4002.....	3.22
HI148-3.....	14.43	HI200M-2.....	8.3	HI38054-100.....	9.46	HI4002-01.....	3.28
HI148-4.....	14.43	HI201.....	15.127	HI38061.....	9.28	HI4003.....	3.22
HI151.....	1.48	HI2014-18 Series.....	15.57	HI38061-100.....	9.46	HI4003-01.....	3.28
HI151 (Checktemp®4).....	1.49	HI2014-28 Series.....	15.57	HI38067.....	9.29	HI4004.....	3.23
HI151-000 (Checktemp®4).....	1.49	HI2020 (edge®).....	2.29	HI38067-100.....	9.46	HI4004-00.....	3.29
HI151-1 (Checktemp®4).....	1.49	HI2020-01 (edge®).....	2.29	HI38074.....	9.12	HI4004-01.....	3.28
HI151-100 (Checktemp®4).....	1.49	HI2020-02 (edge®).....	2.29	HI38074-100.....	9.46	HI4004-45.....	3.28
HI151-2 (Checktemp®4).....	1.49	HI2020-03 (edge®).....	2.29	HI3810.....	9.26	HI4004-51.....	3.30
HI151-200 (Checktemp®4).....	1.49	HI2030 (edge®).....	5.21	HI3810-100.....	9.44, 9.46	HI4005-00.....	3.29
HI151-3 (Checktemp®4).....	1.49	HI2030-01 (edge®).....	5.21	HI3811.....	9.10	HI4005-01.....	3.28
HI151-300 (Checktemp®4).....	1.49	HI2030-02 (edge®).....	5.21	HI3811-100.....	9.44, 9.45, 9.46	HI4005-03.....	3.28
HI151-4 (Checktemp®4).....	1.49	HI2031B.....	2.157	HI3812.....	9.20	HI4005-40.....	3.28
HI151-400 (Checktemp®4).....	1.49	HI2040 (edge®DO).....	6.16	HI3812-100.....	9.44, 9.45	HI4005-45.....	3.28
HI151-5 (Checktemp®4).....	1.49	HI2040-01 (edge®DO).....	6.16	HI3814.....	9.34	HI4005-53.....	3.30
HI151-500 (Checktemp®4).....	1.49	HI2040-02 (edge®DO).....	6.16	HI3815.....	9.13	HI4007.....	3.23
HI180.....	8.8	HI2111B.....	2.171	HI3815-100.....	9.44, 9.45	HI4007-01.....	3.28
HI180-1.....	8.8	HI2112B.....	2.171	HI3817.....	9.37	HI4007-02.....	3.28
HI180-2.....	8.8	HI2202-01.....	2.39	HI3817BP.....	9.39	HI4007-03.....	3.28
HI180A-1.....	8.8	HI2202-01 (edge®blu).....	2.39	HI3818.....	9.13	HI4008.....	3.24
HI180A-2.....	8.8	HI2202-02 (edge®blu).....	2.39	HI3818-100.....	9.44, 9.46	HI4008-01.....	3.28
HI180C-1.....	8.8	HI2910B.....	15.119	HI3820.....	9.10	HI4009.....	3.24
HI180C-2.....	8.8	HI2910B/10.....	15.119	HI3820-100.....	9.44, 9.46	HI4010.....	3.25
HI180E-1.....	8.8	HI2910B/15.....	15.119	HI3821.....	9.33	HI4010-00.....	3.29
HI180E-2.....	8.8	HI2910B/5.....	15.119	HI3822.....	9.30	HI4010-01.....	3.28
HI180F-1.....	8.8	HI2911B/5.....	15.119	HI3822-100.....	9.44, 9.45	HI4010-02.....	3.28
HI180F-2.....	8.8	HI2930B/5.....	15.119	HI3823.....	9.35	HI4010-03.....	3.28
HI180I-1.....	8.8	HI2931B/5.....	15.119	HI3824.....	9.11	HI4010-05.....	3.29
HI180I-2.....	8.8	HI3001.....	15.129	HI3824-025.....	9.44	HI4010-06.....	3.29
HI180J-1.....	8.8	HI3001D.....	15.129	HI3826.....	9.11	HI4010-10.....	3.28
HI180J-2.....	8.8	HI3001D/10.....	15.129	HI3826-025.....	9.44, 9.46	HI4010-11.....	3.28
HI180K-1.....	8.8	HI3001D/5.....	15.129	HI3827.....	9.32	HI4010-12.....	3.28
HI180K-2.....	8.8	HI3002.....	15.129	HI3829F.....	9.14	HI4010-30.....	3.28
HI180L-1.....	8.8	HI3003/D.....	15.129	HI3829F-050.....	9.45	HI4011.....	3.25
HI180L-2.....	8.8	HI30033.....	15.39	HI3830.....	9.12	HI4011-01.....	3.28
HI180M-1.....	8.8	HI300N.....	8.4	HI3830-060.....	9.45	HI4012.....	3.26
HI180M-2.....	8.8	HI300N-1.....	8.4	HI3831F.....	9.14	HI4012-00.....	3.29
HI180W-1.....	8.8	HI300N-2.....	8.4	HI3831F-050.....	9.45	HI4012-01.....	3.28
HI180W-2.....	8.8	HI3011.....	15.129	HI3831T.....	9.17	HI4012-21.....	3.28
				HI3831T-050.....	9.45	HI4013.....	3.26
				HI3833.....	9.27	HI4013-00.....	3.29
				HI3833-050.....	9.44, 9.45, 9.46	HI4013-01.....	3.28
				HI3834.....	9.23	HI4013-02.....	3.28
				HI3834-050.....	9.44, 9.45	HI4013-03.....	3.28
				HI3835.....	9.28	HI4013-06.....	3.29

HI4013-51	3.30	HI510	15.48	HI6200405	15.116	HI7007M	2.183
HI4013-53	3.30	HI510-0320	15.56	HI6200505	15.116	HI70080C	5.41
HI4014	3.26	HI510-0540	15.56	HI6221	2.8	HI70080P	5.41
HI4014-00	3.29	HI510-01	15.53, 15.56	HI6291005	15.119	HI70082M	2.185
HI4014-01	3.28	HI510-02	15.54, 15.56	HI629113	2.170	HI70083M	2.185
HI4014-51	3.30	HI510-03	15.55, 15.56	HI6293005	15.119	HI7009/1G	2.185
HI4015	3.27	HI5110B	2.171	HI6321	5.6	HI7009/1L	2.185
HI4015-00	3.29	HI5124	2.179	HI6421	6.4	HI7009L	2.185
HI4015-01	3.28	HI520	15.48	HI6421P	6.4	HI7009L/C	2.185
HI4016-00	3.29	HI520-0320	15.56	HI6493005	15.119	HI7009M	2.185
HI4016-01	3.28	HI520-0540	15.56	HI700	10.125	HI701	10.129
HI4016-02	3.28	HI5221	2.22	HI700-11	10.125, 10.152	HI701-11	10.129, 10.152
HI4016-03	3.28	HI5221-01	2.22	HI700-25	10.125, 10.152	HI701-25	10.129, 10.152
HI4016-10	3.28	HI5221-02	2.22	HI70000P	2.189	HI7010-012	2.184
HI4016-45	3.28	HI5221-03	2.23	HI700044P	2.182	HI7010-023	2.184
HI4016-46	3.28	HI5222	2.18, 3.12	HI70004C	2.182	HI7010-050	2.184
HI4020-11	13.9	HI5222-01	2.18, 3.12	HI70004G	2.182	HI7010/1G	2.184
HI40227	10.132	HI5222-02	2.18, 3.12	HI70004P	2.182	HI7010/1L	2.184
HI40228	10.132	HI5222-03	2.21, 3.15	HI70006C	2.185	HI7010C	2.184
HI4101	3.22	HI5300-12	2.187	HI70006P	2.185	HI7010L	2.184
HI4102	3.22	HI5311	2.172	HI700074P	2.183	HI7010L/C	2.184
HI4103	3.22	HI5312	2.173	HI70007C	2.183	HI7010M	2.184
HI4104	3.23	HI5313	2.173	HI70007G	2.183	HI7014	10.129
HI4104-51	3.30	HI5314	2.172	HI70007P	2.183	HI702	10.135
HI4105	3.23	HI5315	3.27	HI70009C	2.185	HI702-11	10.135, 10.152
HI4107	3.23	HI5321	5.16	HI70009P	2.185	HI702-25	10.135, 10.152
HI4108	3.24	HI5321-01	5.16	HI70010C	2.184	HI7021L	2.186
HI4109	3.24	HI5321-02	5.16	HI70010P	2.184	HI7021M	2.186
HI4110	3.25	HI5412	2.172	HI7001L	2.185	HI70224L	2.186
HI4110-51	3.30	HI5413	2.173	HI7001M	2.185	HI7022L	2.186
HI4111	3.25	HI5414	2.172	HI700224P	2.186	HI7022M	2.186
HI4112	3.26	HI5421	6.14	HI70022P	2.186	HI7023/1L	3.30
HI4113	3.26	HI5421-01	6.14	HI70024L	5.42	HI7023L	3.30
HI4113-51	3.30	HI5421-02	6.14	HI70024M	5.42	HI7023M	3.30
HI4113-53	3.30	HI54710	2.179	HI70024P	5.42	HI7024	10.135
HI4114	3.26	HI54710-10	2.179	HI7003004P	2.187	HI7024-11	10.135
HI4114-51	3.30	HI54710-11	2.179	HI700304P	5.39	HI7024-25	10.135
HI4115	3.27	HI5521	7.10	HI70030C	5.39	HI7030/1G	5.39
HI4211T	15.126	HI5521-01	7.10	HI70030P	5.39	HI7030/1L	5.39
HI4430B	2.160	HI5521-02	7.10	HI70031C	5.37	HI70300-012	2.187
HI50001-02	2.179	HI5522	3.6, 3.11, 7.4	HI70031G	5.37	HI70300-023	2.187
HI50002-02	2.179	HI5522-01	3.6, 3.11, 7.4	HI70031P	5.37	HI70300-050	2.187
HI50003-02	2.179	HI5522-02	3.6, 3.11, 7.4	HI70032C	5.41	HI703004L	2.187
HI50004-02	2.179	HI60001-02	2.180	HI70032P	5.41	HI70300G	2.187
HI50005-02	2.179	HI60002-02	2.180	HI700384P	5.41	HI70300L	2.187
HI50007-02	2.179	HI60002-02	2.180	HI70038C	5.41	HI70300M	2.187
HI50009-02	2.179	HI60004-02	2.180	HI70038P	5.41	HI70300P	2.187
HI5001	2.179	HI60007-02	2.180	HI70039C	5.38	HI70300S	2.187
HI50010-02	2.179	HI6001	2.180	HI70039G	5.38	HI7030L	5.39
HI50011-02	2.179	HI60010-02	2.180	HI70039P	5.38	HI7030L/C	5.39
HI50012-02	2.179	HI60016-02	2.180	HI7004-012	2.182	HI7030M	5.39
HI50013-02	2.179	HI6002	2.180	HI7004-023	2.182	HI7031-012	5.37
HI50016-02	2.179	HI6003	2.180	HI7004-050	2.182	HI7031-023	5.37
HI5002	2.179	HI6004	2.180	HI7004/1G	2.182	HI7031/1G	5.37
HI5002-01	2.179	HI6004-01	2.180	HI7004/1L	2.182	HI7031/1L	5.37
HI50021P	7.55	HI6006	2.180	HI7004C	2.182	HI7031L	5.37
HI5003	2.179	HI6007	2.180	HI7004L	2.182	HI7031L/C	5.37
HI50036P	2.181, 5.42	HI6007-01	2.180	HI7004L/C	2.182	HI7031M	5.37
HI5004	2.179	HI6008	2.180	HI7004M	2.182	HI7032/1L	5.41
HI5004-01	2.179	HI6009	2.180	HI7006/1G	2.185	HI7032L	5.41
HI5004-R	2.179	HI6010	2.180	HI7006/1L	2.185	HI7032M	5.41
HI5004-R08	2.179	HI6010-01	2.180	HI7006014P	2.189	HI7033/1L	5.36
HI5005	2.179	HI6011	2.180	HI700601P	2.189	HI7033L	5.36
HI5005-01	2.179	HI6012	2.180	HI70060M	2.185	HI7033M	5.36
HI5006	2.179	HI6013	2.180	HI70061G	2.189	HI7034/1L	5.40
HI50068-02	2.179	HI6016	2.180	HI70063P	2.189	HI7034L	5.40
HI5007	2.179	HI6031	5.37	HI7006621P	2.189	HI7034M	5.40
HI5007-01	2.179	HI6032	5.41	HI700630P	2.189	HI7035/1L	5.40
HI5007-G	2.179	HI6033	5.36	HI700635P	2.189	HI7035L	5.40
HI5007-G08	2.179	HI6050	15.132	HI700636P	2.189	HI7035M	5.40
HI5008	2.179	HI60501	15.134	HI700640P	2.189	HI7036/1L	5.41
HI5008-01	2.179	HI60501-0	15.134	HI700641P	2.189	HI7036L	5.41
HI5009	2.179	HI605011	15.134	HI700642P	2.189	HI7037	3.30
HI50091-02	2.179	HI60503	15.134	HI700643P	2.189	HI7037L	5.42
HI5010	2.179	HI60503	15.134	HI700661P	2.189	HI7037M	3.30
HI5010-01	2.179	HI6051	15.132	HI700663P	2.189	HI7037M	5.42
HI5010-V	2.179	HI6052	15.132	HI700664P	2.189	HI7039-012	5.38
HI5010-V08	2.179	HI60542	15.130	HI700670P	2.189	HI7039-023	5.38
HI5011	2.179	HI60545	15.131	HI700671P	2.189	HI7039/1L	5.38
HI5012	2.179	HI605453	5.31	HI700680P	2.189	HI7039L	5.38
HI50124-02	2.179	HI6054B	15.133	HI700682P	2.189	HI7039M	5.38
HI5013	2.179	HI6054T	15.133	HI700683P	2.189	HI70401	4.56
HI5016	2.179	HI6068	2.180	HI700684P	2.189	HI70402	4.56
HI5030-12	5.39	HI6074	2.180	HI700685P	2.189	HI70403	4.56
HI5031-12	5.37	HI6091	2.180	HI7006L	2.185	HI70404	4.56
HI5033-12	5.36	HI6100205	15.116	HI7006L/C	2.185	HI70405	4.56
HI5034-12	5.40	HI6100405	15.116	HI7006M	2.185	HI70406	4.56
HI5036-012	2.181, 5.42	HI6100410	15.116	HI7007-012	2.183	HI70407	4.56
HI5036-023	2.181, 5.42	HI6100805	15.116	HI7007-023	2.183	HI70408	4.56
HI5036-050	2.181	HI6101205	15.116	HI7007-050	2.183	HI70409	4.56
HI5068	2.179	HI6101405	15.116	HI7007/1G	2.183	HI7040L	6.38, 6.39
HI5074	2.179	HI6101415	15.116	HI7007/1L	2.183	HI7041L	6.36, 6.37, 6.38, 6.40
HI5091	2.179	HI6101605	15.116	HI7007C	2.183	HI7041M	6.36, 6.37, 6.38, 6.40
		HI6101805	15.116	HI7007L	2.183	HI7041S	6.36, 6.37, 6.38, 6.40
		HI6124	2.180	HI7007L/C	2.183	HI70422	4.56

HI70423	4.56	HI7061M	2.189	HI710030	7.53, 14.45	HI731320	8.4
HI70424	4.56	HI70621L	2.189	HI710032	2.25	HI731321	10.152, 12.25
HI70425	4.56	HI70630L	2.189	HI710033	2.25	HI731324	15.95
HI70426	4.56	HI70631L	2.189	HI710034	7.36, 7.37	HI731331	10.52
HI70427	4.56	HI70632L	2.189	HI710035	2.88, 2.92, 2.96	HI731331	11.19
HI70428	4.56	HI70635L	2.189	HI710045	7.27	HI731331N	12.24
HI70429	4.56	HI70636L	2.189	HI710046	7.27	HI731335N	11.19, 12.24, 12.25, 12.26
HI70428B	15.65	HI70640L	2.189	HI710140	7.27	HI731336N	10.52
HI70425	6.39	HI70641L	2.189	HI7101412	10.52	HI731339P	10.127
HI70430	15.15	HI70642L	2.189	HI7101413	10.52	HI731340	11.19
HI70431	15.15	HI70643L	2.189	HI7101415	10.52	HI731341	11.19, 12.26
HI70432	4.39, 4.56	HI70663L	2.189	HI7101417	10.52	HI731342	4.61, 4.62, 11.19
HI70433	4.56	HI70664L	2.189	HI7101418	10.52	HI731349P	10.127
HI70434	4.56	HI70670L	2.189	HI7101419	10.91, 10.93	HI731350	11.19
HI70435	4.56	HI70671L	2.189	HI710142	2.120	HI731351	11.19, 12.26
HI70436	4.56, 10.152	HI70681L	2.189	HI711	10.130	HI731352	4.61, 4.62, 11.19
HI70436M	4.56, 10.152	HI70682L	2.189	HI711-11	10.130, 10.152	HI731359	10.134
HI70437	4.56	HI707	10.145	HI711-25	10.130, 10.152	HI731360	10.52
HI70438	4.56	HI707-11	10.145, 10.152	HI713	10.149	HI733	10.125
HI70439	4.56	HI707-25	10.145, 10.152	HI713-11	10.149, 10.152	HI733-11	10.125, 10.152
HI70440	4.56	HI70701/1L	3.30	HI713-25	10.149, 10.152	HI733-25	10.125, 10.152
HI70441	4.56	HI70701L	3.30	HI7134	10.149	HI73311	1.68
HI70442/1L	5.41	HI70701M	3.30	HI7134-11	10.149	HI735	10.137
HI70442L	5.41	HI70702/1L	3.30	HI7134-25	10.149	HI735-11	10.137, 10.152
HI70442M	5.41	HI70702L	3.30	HI715	10.125	HI735-25	10.137, 10.152
HI70442P	5.41	HI70702M	3.30	HI715-11	10.125, 10.152	HI736	10.150
HI70443	4.56	HI70703/1L	3.30	HI715-25	10.125, 10.152	HI736-11	10.150, 10.152
HI70444	4.56	HI70703L	3.30	HI716	10.126	HI736-25	10.150, 10.152
HI70445	4.56	HI70703M	3.30	HI716-11	10.126, 10.152	HI739	10.136
HI70446	4.56	HI7071	2.190	HI716-25	10.126, 10.152	HI739-11	10.136, 10.152
HI70447	4.56	HI7071L	2.190	HI7164	15.94	HI739-26	10.136, 10.152
HI70448	4.56	HI7071M	2.190	HI717	10.149	HI740031	15.118
HI70449	4.56	HI7072	2.190	HI717-11	10.149, 10.152	HI740034P	11.19
HI70450	15.15	HI7072	3.29	HI717-25	10.149, 10.152	HI740036P	4.60, 4.61, 4.62, 10.152
HI70451	15.15	HI7072L	2.190	HI718	10.139	HI740037P	4.61, 4.62
HI70452	15.15	HI7073L	2.189	HI718-11	10.139, 10.152	HI740142P	12.26
HI70453	4.56	HI7073M	2.189	HI718-25	10.139, 10.152	HI740143	10.137, 10.152
HI70454	4.56	HI7074L	2.189	HI719	10.138	HI740144P	10.137, 10.152, 12.26
HI70455	4.56	HI7074M	2.189	HI719-11	10.138, 10.152	HI740155P	2.190
HI70456	4.39, 4.56	HI7075	2.190, 3.29	HI719-25	10.138, 10.152	HI740157P	10.137, 10.152
HI70457	4.39, 4.56	HI7076	2.190, 3.29	HI720	10.138	HI740159	3.30
HI70458	4.56	HI70774L	2.189	HI720-11	10.138, 10.152	HI740216	11.24
HI70459	4.56	HI7077L	2.189	HI720-25	10.138, 10.152	HI740217	11.24
HI70460	15.15	HI7077M	2.189	HI720029	15.107	HI740220	12.26
HI70461	15.15	HI7078	2.190, 3.29	HI720030	15.107	HI740224	11.19
HI70462	4.56	HI7079	3.29	HI720031	15.107	HI740225	11.19
HI70463	4.56	HI708	10.145	HI720032	15.107	HI740226	10.112, 10.152, 11.19
HI70464	4.56	HI708-11	10.145, 10.152	HI720161	2.108, 2.116	HI740228	10.91, 10.93
HI70465	4.56	HI708-25	10.145, 10.152	HI720169	2.112	HI740233	12.26
HI70466	4.56	HI7080L	3.30	HI720190	2.84	HI740234	12.24, 12.26
HI70467	4.56	HI7080M	3.30	HI720191	3.17	HI740236	4.60, 4.61, 4.62
HI70468	4.56	HI7081/1L	3.30	HI720192	5.28	HI740244	2.158
HI70469	4.56	HI7081L	3.30	HI720193	6.30	HI740245	2.158
HI70471	4.56	HI7081M	3.30	HI720194	7.37	HI740246	7.33
HI70472	4.56	HI7082	2.190	HI720197	5.32	HI740270	10.91, 10.93
HI70473	15.15	HI7082	3.29	HI720199	2.81	HI740271	10.91, 10.93
HI70474	15.15	HI7082L	2.190	HI72083300	11.19	HI740272	10.91, 10.93
HI70475	15.15	HI7082M	2.190	HI7209811	7.55, 7.57	HI740273	10.91, 10.93
HI70476	15.15	HI7083L	3.30	HI721	10.140	HI7408011	10.20
HI70477	15.15	HI7083M	3.30	HI721-11	10.140, 10.152	HI7408012	10.20
HI70478	15.15	HI7084L	3.30	HI721-25	10.140, 10.152	HI7408013	10.20
HI70479	15.15	HI7084M	3.30	HI721003	15.107	HI7408014	10.20
HI70480	15.15	HI7085L	3.30	HI721004	15.105, 15.107	HI7408015	10.20
HI70481	15.15	HI7085M	3.30	HI721005	15.105, 15.107	HI746	10.140
HI70482	15.15	HI7086L	3.30	HI721006	15.107	HI746-11	10.140, 10.152
HI70483	15.15	HI7086M	3.30	HI721008	15.105, 15.107	HI746-25	10.140, 10.152
HI70484	15.15	HI7087L	3.30	HI721101	15.105, 15.107	HI747	10.135
HI70485	15.15	HI7087M	3.30	HI721102	15.105, 15.107	HI747-11	10.135, 10.152
HI70486	15.15	HI7088L	3.30	HI721103	15.105, 15.107	HI747-25	10.135, 10.152
HI704871	15.15	HI7088M	3.30	HI721104	15.105	HI749	10.131
HI70488	15.15	HI7089L	3.30	HI721106	15.105	HI749-11	10.131, 10.152
HI70489	15.15	HI7089M	3.30	HI721319	2.71, 2.116, 2.121	HI749-25	10.131, 10.152
HI70490	15.15	HI709	10.141	HI7214	10.140	HI75110/220E	10.27
HI70491	15.15	HI709-11	10.141, 10.152	HI723	10.131	HI75110/220E	11.19
HI70492	15.15	HI709-25	10.141, 10.152	HI723-11	10.131, 10.152	HI75110/220U	10.27
HI70493	15.15	HI7090L	3.30	HI723-25	10.131, 10.152	HI75110/220U	11.19
HI70495	15.15	HI7090M	3.30	HI726	10.142	HI753	10.128
HI70496	15.15	HI7091L	2.186	HI726-11	10.142, 10.152	HI753-11	10.128, 10.152
HI70497	15.15	HI7092L	2.186	HI726-25	10.142, 10.152	HI753-25	10.128, 10.152
HI705	10.151	HI7092M	2.186	HI727	10.132	HI755	10.123
HI705-11	10.151, 10.152	HI70960	2.186	HI727-11	10.132, 10.152	HI755-11	10.123, 10.152
HI705-25	10.151, 10.152	HI710005/8	7.23, 7.24	HI729	10.136	HI755-26	10.123, 10.152
HI70500	4.60, 4.61, 4.62	HI7100051/8	4.60, 4.61, 4.62	HI729-11	10.136, 10.152	HI758	10.127
HI7051L	2.186	HI710006/8	7.23, 7.24	HI729-26	10.136, 10.152	HI758-11	10.127, 10.152
HI7051M	2.186	HI7100061/8	4.60, 4.61, 4.62	HI729113	2.170	HI758-26	10.91, 10.93, 10.127, 10.152
HI706	10.150	HI710007	2.138, 5.34, 5.35, 7.55, 7.57	HI729118	2.170	HI758U-26	10.91, 10.93
HI706-11	10.150, 10.152	HI710008	2.138, 5.34, 5.35, 7.55, 7.57	HI73120	1.68	HI759	10.134
HI706-25	10.150, 10.152	HI710009	2.139	HI731225	10.152	HI759-11	10.134
HI706023	14.45	HI710015	2.137, 14.46	HI73127	1.68	HI7609829	7.17
HI7061-012	2.189	HI710025	14.10	HI73128	1.9	HI7609829-0	7.18
HI7061-023	2.189	HI710026	14.26, 14.28	HI731313	12.25	HI7609829-1	7.18, 7.26
HI7061-050	2.189	HI710027	14.30, 14.32	HI731315	10.152	HI7609829-10	7.18, 7.26
HI70614L	2.189	HI710028	14.45	HI731318	10.52, 10.152, 11.19	HI7609829-11	7.18, 7.26
HI7061L	2.189	HI710029	2.127, 2.128, 2.132	HI731319	4.58, 4.60, 4.61, 4.62	HI7609829-12	7.18, 7.26

HI7609829-2.....	7.18, 7.26	HI76510-05.....	15.56	HI772-11.....	10.123, 10.152	HI83300.....	10.28
HI7609829-3.....	7.19, 7.26	HI76510-10.....	15.56	HI772-26...10.91, 10.93, 10.123, 10.152		HI83300-01.....	10.28
HI7609829-4.....	7.19, 7.26	HI76510-15.....	15.56	HI77200P.....	2.183, 5.41	HI83300-02.....	10.28
HI7609829/10.....	7.26	HI76510-25.....	15.56	HI774.....	10.149	HI83300-100.....	11.19
HI7609829/20.....	7.26	HI76510-50.....	15.56	HI774-11.....	10.149, 10.152	HI83300-11.....	10.31
HI7609829/4.....	7.26	HI7662.....	2.137	HI774-25...10.91, 10.93, 10.149, 10.152		HI83303.....	10.32
HI761.....	10.130, 10.130	HI7662-A.....	4.60	HI77400C.....	2.182	HI83303-01.....	10.32
HI761-11.....	10.130, 10.152	HI7662-AW.....	4.58	HI77400P.....	2.182, 2.183	HI83303-02.....	10.32
HI761-25.....	10.130, 10.152	HI7662-T.....	2.25, 4.39, 4.60	HI775.....	10.123	HI83303-11.....	10.33
HI7610.....	15.130	HI7662-TW.....	4.57	HI775-11.....	10.123, 10.152	HI83305.....	10.34
HI762.....	10.129	HI7662-W.....	2.21	HI775-26.....	10.97, 10.123, 10.152	HI83305-01.....	10.34
HI762-004F.....	14.21	HI7669-1.....	2.138	HI7754.....	10.123	HI83305-02.....	10.34
HI762-11.....	10.129, 10.152	HI7669AW.....	2.138	HI7754-11.....	10.123	HI83305-11.....	10.35
HI762-18C.....	14.21	HI766A.....	14.14	HI7754-26.....	10.123	HI83306.....	10.36
HI762-25.....	10.129, 10.152	HI766B.....	14.14	HI77700P.....	2.183	HI83306-01.....	10.36
HI762000C.....	14.21	HI766B1.....	14.15	HI779.....	10.148	HI83306-02.....	10.36
HI762032F.....	14.21	HI766B2.....	14.15	HI779-11.....	10.148, 10.152	HI83306-11.....	10.37
HI762070C.....	14.21	HI766B3.....	14.15	HI779-25.....	10.148, 10.152	HI83308.....	10.46
HI762158F.....	14.21	HI766C.....	14.12	HI780.....	10.147	HI83308-01.....	10.46
HI7629829.....	7.17	HI766C1.....	14.12	HI780-11...10.91, 10.93, 10.147, 10.152		HI83308-02.....	10.46
HI7629829/10.....	7.26	HI766CL.....	14.12	HI780-25...10.91, 10.93, 10.147, 10.152		HI83308-11.....	10.47
HI7629829/20.....	7.26	HI766D.....	14.12	HI781.....	10.143, 10.152	HI83314.....	11.14
HI7629829/4.....	7.26	HI766E.....	14.11	HI781-11.....	10.143, 10.152	HI83314-01.....	11.15
HI762A.....	14.21	HI766E1.....	14.11	HI781-25...10.91, 10.93, 10.143, 10.152		HI83314-02.....	11.15
HI762BL.....	14.21	HI766E2.....	14.11	HI782.....	10.144	HI83314-11.....	11.15
HI762L.....	14.21	HI766EX.....	14.16	HI782-11.....	10.152	HI83325.....	10.38
HI762L/10.....	14.21	HI766F.....	14.18	HI782-25.....	10.91, 10.93, 10.152	HI83325-01.....	10.38
HI762L/2.....	14.21	HI766F1.....	14.18	HI783.....	10.133	HI83325-02.....	10.38
HI762PBL.....	14.22	HI766F1/5.....	14.18	HI783-11.....	10.133, 10.152	HI83325-11.....	10.39
HI762PW.....	14.22	HI766HD.....	14.16	HI783-25...10.91, 10.93, 10.133, 10.152		HI83326.....	10.44
HI762PWL.....	14.22	HI766PA.....	14.17	HI784.....	10.124	HI83326-01.....	10.44
HI762W.....	14.22	HI766PB.....	14.17	HI784-11.....	10.124, 10.152	HI83326-02.....	10.44
HI762W/10.....	14.22	HI766PC.....	14.16	HI784-25...10.91, 10.93, 10.124, 10.152		HI83326-11.....	10.45
HI7630-28 Series.....	15.62	HI766PD.....	14.16	HI7855.....	2.170	HI83399.....	11.6
HI7630-48 Series.....	15.62	HI766PE1.....	14.17	HI7855/1.....	2.170	HI83399-01.....	11.10
HI76301D.....	5.35	HI766PE2.....	14.17	HI7855/10.....	2.170	HI83399-02.....	11.10
HI76302W.....	5.34	HI766TR1.....	14.13	HI7855/15.....	2.170	HI83399-11.....	11.10
HI763063.....	5.33	HI766TR2.....	14.13	HI7855/3.....	2.170	HI83414.....	12.6
HI763093.....	2.81	HI766TR3.....	14.13	HI7855/5.....	2.170	HI83414-01.....	12.9
HI763100.....	5.25	HI766TR4.....	14.13	HI7858.....	2.170	HI83414-02.....	12.9
HI76312.....	5.17	HI766TV1.....	14.19	HI7858/1.....	2.170	HI83730.....	10.120
HI763123.....	5.31	HI766Z.....	14.19	HI7858/10.....	2.170	HI83730-02.....	10.120
HI7631233.....	5.15	HI766Z/3.....	14.19	HI7858/5.....	2.170	HI83730-20.....	10.121
HI763133.....	5.28	HI766Z/7.....	14.19	HI7871.....	15.94	HI83746.....	10.116
HI7632-00.....	15.86, 15.88, 15.90	HI767.....	10.146	HI7871/115.....	15.94	HI83746-01.....	10.116
HI7632-00/6.....	15.86, 15.88, 15.90	HI767-11.....	10.146, 10.152	HI7871/220.....	15.94	HI83746-02.....	10.116
HI76320.....	4.25, 4.59	HI767-25.....	10.146, 10.152	HI7873.....	15.94	HI83746-20.....	10.117
HI76330.....	4.29, 4.59	HI767TS10.....	14.40	HI7873/115.....	15.94	HI83748.....	10.118
HI7634-00...15.85, 15.87, 15.89, 15.90		HI767TS14.....	14.40	HI7873/220.....	15.94	HI83748-01.....	10.118
HI7634-00/4...15.85, 15.87, 15.89, 15.90		HI767TS2.....	14.40	HI7874.....	15.95	HI83748-02.....	10.118
HI7634-00/5...15.85, 15.87, 15.89, 15.90		HI767TS5.....	14.40	HI8001.....	15.9	HI83748-20.....	10.119
HI7635.....	15.128	HI767TS7.....	14.40	HI8001-0100U.....	15.9	HI83749.....	12.21
HI7638.....	15.128	HI7698194.....	7.36, 7.37	HI8001-0200D.....	15.9	HI83749-01.....	12.21
HI7638/10.....	15.128	HI7698194-0.....	7.31, 7.36	HI8001-0400U.....	15.9	HI83749-02.....	12.21
HI7638/20.....	15.128	HI7698194-1.....	7.31, 7.36	HI8004L.....	2.182	HI83749-11.....	12.21, 12.26
HI7639.....	15.128	HI7698194-2.....	7.36	HI8004L/C.....	2.182	HI83749-20.....	12.21, 12.26
HI764.....	10.146	HI7698194-3.....	7.31, 7.36	HI8006L.....	2.185	HI83900.....	10.40
HI764-11.....	10.146, 10.152	HI7698194/10.....	7.37	HI8006L/C.....	2.185	HI83900-25.....	10.40
HI764-25...10.91, 10.93, 10.146, 10.152		HI7698194/20.....	7.37	HI8007L.....	2.183	HI83900-30.....	10.40
HI7640-18 Series.....	15.64	HI7698194/40.....	7.37	HI8007L/C.....	2.183	HI83900-60.....	10.40
HI7640-18A/P.....	15.65	HI76981942.....	7.37, 7.49	HI8009L.....	2.185	HI83900-90.....	10.40
HI7640-58 Series.....	15.66	HI7698195.....	7.40, 7.41, 7.44	HI8009L/C.....	2.185	HI839800.....	10.117
HI76404A.....	11.19	HI7698195/10.....	7.41	HI801.....	10.20	HI839800-01.....	11.24
HI76404W.....	2.21, 2.23	HI7698195/20.....	7.41	HI801-01.....	10.20	HI839800-02.....	11.24
HI764060.....	2.16	HI7698195/40.....	7.41	HI801-02.....	10.20	HI8410.....	15.77
HI76407/10.....	6.40	HI76981952.....	7.41	HI801-11.....	10.21	HI8424.....	2.137
HI76407/10F.....	6.38	HI7698196.....	7.48, 7.49	HI801-10.....	2.184	HI84500.....	4.52
HI76407/2.....	6.40	HI7698196/10.....	7.49	HI8010L.....	2.184	HI84500-01.....	4.52
HI76407/20.....	6.40	HI7698196/20.....	7.49	HI8010L/C.....	2.184	HI84500-02.....	4.52
HI76407/20F.....	6.38	HI7698196/40.....	7.49	HI80300L.....	2.187	HI84500-50.....	4.62
HI76407/4.....	6.40	HI7698290.....	7.27, 7.37, 7.41, 7.49	HI80300M.....	2.187	HI84500-51.....	4.62
HI76407/4F.....	6.38	HI7698291.....	7.27	HI8030L.....	5.39	HI84500-55.....	4.62
HI764073/10.....	6.30, 6.38	HI76982910.....	7.27	HI8031L.....	5.37	HI84500-60.....	4.62
HI76407A/P.....	6.38, 6.40	HI7698292.....	7.27	HI8033L.....	5.36	HI84500-61.....	4.62
HI764080.....	6.36	HI7698293.....	7.27	HI8034L.....	5.40	HI84500-62.....	4.62
HI764080A/P.....	6.36	HI7698294.....	7.27	HI8035L.....	5.40	HI84502.....	4.54
HI76409/10.....	6.39	HI7698295...7.18, 7.27, 7.37, 7.41, 7.49		HI8039L.....	5.38	HI84502-01.....	4.54
HI76409/4.....	6.39	HI7698296.....	7.19, 7.27	HI8051-0300D.....	15.9	HI84502-02.....	4.54
HI76409A/P.....	6.39	HI7698297.....	7.27	HI8061L.....	2.189	HI84502-50.....	4.62
HI76410/10.....	15.77	HI7698297.....	7.27	HI8071.....	2.190	HI84502-55.....	4.62
HI76410/4.....	15.77	HI7698494.....	7.31, 7.33	HI8073L.....	2.189	HI84529.....	4.46
HI764103.....	2.81	HI7698494-5.....	7.31	HI8077L.....	2.189	HI84529-01.....	4.46
HI76410A.....	15.77	HI7698494/10.....	7.33	HI8080L.....	3.30	HI84529-02.....	4.46
HI764113.....	6.27, 6.34	HI7698494/20.....	7.33	HI8082.....	2.190	HI84529-50.....	4.61
HI764113-1.....	6.27, 6.34	HI7698494/40.....	7.33	HI8086L.....	3.30	HI84529-51.....	4.61
HI764113-2.....	6.34, 6.35	HI770.....	10.151	HI8087L.....	3.30	HI84529-52.....	4.61
HI764113-3.....	6.34, 6.35	HI770-11.....	10.151, 10.152	HI8088L.....	3.30	HI84529-55.....	4.61
HI764113/10.....	6.34	HI770-25.....	10.151, 10.152	HI8093.....	2.190		
HI764113/20.....	6.34	HI770710C.....	2.183, 2.184	HI829113.....	2.81		
HI7641133.....	6.34	HI770710P.....	2.183, 2.184	HI8299505.....	15.119		
HI76483.....	6.37	HI771.....	10.130	HI8314-1.....	2.138		
HI764833.....	6.37	HI771-11.....	10.130, 10.152	HI83141-1.....	2.138		
HI76483A/P.....	6.37	HI771-25.....	10.130, 10.152	HI83224.....	11.4		
		HI77100C.....	2.183, 5.37	HI83224-01.....	11.5		
		HI77100P.....	2.183, 5.37	HI83224-02.....	11.5		
		HI772.....	10.123				

HI84530	4.42	HI900528	4.59	HI922	4.12	HI93701-01	10.62, 10.95, 10.97
HI84530-01	4.42	HI900530	4.59	HI922-100	4.12	HI93701-03	10.62, 10.74, 10.97
HI84530-02	4.42	HI900531	4.59	HI922-110	4.12	HI93701-F	10.62, 10.97, 10.100
HI84530-50	4.60	HI900532	4.59	HI922-120	4.12	HI93701-T	10.97, 10.103
HI84530-51	4.60	HI900533	4.59	HI922-130	4.12	HI93702-01	10.66, 10.114
HI84530-55	4.60	HI900534	4.59	HI922-200	4.12	HI93702-03	10.66, 10.114
HI84530-60	4.60	HI900535	4.59	HI922-210	4.12	HI93702T-01	10.114
HI84531	4.44	HI900536	4.59	HI922-220	4.12	HI93702T-03	10.114
HI84531-01	4.44	HI900540	4.59	HI922-230	4.12	HI93703	12.20
HI84531-02	4.44	HI900570S	4.59	HI92500	15.15	HI93703-0	12.25
HI84531-50	4.61	HI900580S	4.59	HI9298194	7.37	HI93703-05	12.25
HI84531-51	4.61	HI900601	4.31	HI929829	7.27	HI93703-10	12.25
HI84531-55	4.61	HI900602	4.31	HI930100	4.57	HI93703-11	12.20
HI84532	4.48	HI900603	4.31	HI930101	4.57	HI93703-50	10.52, 10.152
HI84532-01	4.48	HI900604	4.31	HI930105	4.57	HI93703-51	10.114
HI84532-02	4.48	HI900805	4.39	HI930110	4.57	HI93703-52	10.114
HI84532-50	4.61	HI900942	4.39, 4.57, 4.59	HI930125	4.57	HI93703-53	10.69
HI84532-51	4.61	HI900945	4.57	HI930150	4.57	HI93703-55	11.19
HI84532-55	4.61	HI900946	4.39, 4.57	HI930180	4.59	HI93703-56	10.112
HI84533	4.50	HI900947	4.39, 4.57	HI930182	4.59	HI93703-57	10.112
HI84533-01	4.50	HI901W	4.36	HI930190	4.57	HI93703-59	10.117
HI84533-02	4.50	HI901W-01	4.36	HI930191	4.57	HI93703C	12.20
HI84533-50	4.62	HI901W-02	4.36	HI930201	4.57	HI93704-01	10.72, 10.114
HI84533-55	4.62	HI9071	2.190	HI930202	4.57	HI93704-03	10.72, 10.114
HI84533-60	4.62	HI9142	6.33	HI930204	4.57	HI93705-01	10.84, 10.114
HI84533-61	4.62	HI9146	6.32	HI930280	4.57	HI93705-03	10.84, 10.114
HI84533-62	4.62	HI9146-04	6.32	HI930301	4.57, 4.58	HI93706-01	10.82, 10.114
HI84534	4.40	HI9146-10	6.32	HI930302	4.57, 4.58	HI93706-03	10.82, 10.114
HI84534-01	4.40	HI9147	6.31	HI930303	4.57, 4.58	HI93707-01	10.79, 10.114
HI84534-02	4.40	HI9147-04	6.31	HI930310	4.57	HI93707-03	10.79, 10.114
HI84534-50	4.60	HI9147-10	6.31	HI930311	4.57	HI93708-01	10.79, 10.114
HI84534-55	4.60	HI9147-15	6.31	HI930320	4.57	HI93708-03	10.79, 10.114
HI847492	12.22	HI920-053	4.58, 4.60	HI930330	4.57	HI93709-01	10.75, 10.114
HI847492-01	12.23	HI920-060	4.58, 4.60	HI930401	4.57	HI93709-03	10.75, 10.114
HI847492-02	12.23	HI920-101	4.60	HI930505	4.59	HI93710-01	10.95, 10.97, 10.99
HI847492-11	12.23, 12.26	HI920-102	4.60	HI930520	4.59	HI93710-03	10.97, 10.99, 10.101
HI8510	15.70	HI920-103	4.58	HI930521	4.59	HI93711-01	10.95, 10.97, 10.99
HI8512	15.74	HI920-104	4.58	HI930525	4.59	HI93711-03	10.97, 10.99, 10.103
HI8614	15.102	HI920-111	4.60	HI930560	4.59	HI93712-01	10.53, 10.114
HI8614LN	15.102	HI920-112	4.60	HI930800	4.57	HI93712-03	10.53, 10.114
HI8614N	15.102	HI920-113	4.58	HI930803	4.59	HI93713-01	10.81, 10.114
HI8615	15.102	HI920-11660	4.60	HI930804	4.59	HI93713-03	10.81, 10.114
HI8615LN	15.102	HI920-11660W	4.58	HI930805	4.57	HI93714-01	10.67, 10.114
HI8615N	15.102	HI920-11853	4.60	HI930806	4.59	HI93714-03	10.67, 10.114
HI8710	15.71	HI920-11853W	4.58	HI930807	4.59	HI93715-01	10.54, 10.114
HI8711	15.72	HI920-191	4.58	HI930900U	4.57	HI93715-03	10.54, 10.114
HI8720	15.73	HI920-201	4.58, 4.60	HI930939	4.59	HI93716-01	10.57, 10.95, 10.114
HI8733	5.34	HI920-202	4.60	HI931	4.16	HI93716-01	12.25
HI8734	5.35	HI920-203	4.58, 4.60	HI931-01	4.16	HI93716-03	10.57, 10.114
HI88703	12.10	HI920-204	4.58, 4.60	HI931-02	4.16	HI93716-03	12.25
HI88703-01	12.11	HI920-205	4.58, 4.60	HI931001	2.139	HI93717-01	10.81, 10.114
HI88703-02	12.11	HI920-206	4.60	HI9310014	2.139	HI93717-03	10.81, 10.114
HI88703-11	12.24	HI920-207	4.60	HI93102	12.16	HI93717-11	11.23
HI88713	12.18, 12.19	HI920-208	4.58	HI93102-0	12.25	HI93718-01	10.73, 10.95, 10.114
HI88713-01	12.18, 12.19	HI920-208S	4.60	HI93102-20	12.25	HI93718-03	10.73, 10.114
HI88713-02	12.18, 12.19	HI920-281	4.58	HI932	4.6	HI93719-01	10.70, 10.101
HI88713-11	12.25	HI920-290	4.58, 4.60	HI932C1-01	4.6	HI93719-03	10.70, 10.101
HI8931	15.75	HI920-301	4.60	HI932C1-02	4.6	HI93720-01	10.70, 10.114
HI8931AN	15.75	HI920-302	4.60	HI932C2-01	4.6	HI93720-03	10.70, 10.114
HI8931BN	15.75	HI920-303	4.60	HI932C2-02	4.6	HI93721-01	10.74, 10.114
HI8931CN	15.75	HI920-304	4.60	HI933	4.4, 4.22, 4.25	HI93721-03	10.114
HI8931DN	15.75	HI920-310	4.58, 4.60	HI933-01	4.4, 4.22, 4.25	HI93722-01	10.68, 10.95
HI8936	15.103	HI920-320	4.58	HI933-02	4.4, 4.22, 4.25	HI93722-03	10.68, 10.97
HI8936ALN	15.103	HI920-900	4.60	HI934	4.4, 4.26	HI93723-01	10.64, 10.114
HI8936AN	15.103	HI920-901	4.58	HI934-01	4.4, 4.26	HI93723-03	10.64, 10.114
HI8936BLN	15.103	HI920-921	4.60	HI934-02	4.4, 4.26	HI93726-01	10.77, 10.114
HI8936BN	15.103	HI920-922	4.58	HI93414	12.12, 12.13	HI93726-03	10.77, 10.114
HI8936CLN	15.103	HI920-930	4.60	HI93414-01	12.12, 12.13	HI93728-01	10.78, 10.114
HI8936CN	15.103	HI920-931	4.58, 4.60	HI93414-02	12.12, 12.13	HI93728-03	10.78, 10.114
HI8936DLN	15.103	HI920-932	4.58, 4.60	HI93414-11	12.24	HI93729-01	10.69, 10.114
HI8936DN	15.103	HI920-933	4.58	HI934D	4.4, 4.26	HI93729-03	10.69, 10.114
HI900100	4.39	HI920-960	4.58, 4.60	HI934D-01	4.4, 4.26	HI93730-01	10.76, 10.114
HI900105	4.39	HI920000	12.24, 12.25, 12.26	HI934D-02	4.4, 4.26	HI93730-03	10.76, 10.114
HI900110	4.39	HI920005	7.27	HI935001	14.30	HI93731-01	10.87, 10.114
HI900125	4.39	HI920005	12.24, 12.25, 12.26	HI935001-03	14.30	HI93731-03	10.87, 10.114
HI900150	4.39	HI920011	12.24, 12.25	HI9350011	14.32	HI93732-01	10.80, 10.114
HI900205	4.39, 4.57	HI920013	4.39, 4.57, 4.59, 4.60, 4.61	HI935002	14.8	HI93732-03	10.80, 10.114
HI900210	4.39, 4.57	HI920013	12.24, 12.25, 12.26	HI935003	14.10	HI93733-01	10.55, 10.114
HI900225	4.39, 4.57	HI920015	11.19	HI935004	14.31	HI93733-03	10.55, 10.114
HI900250	4.39, 4.57	HI920016	6.26	HI9350041	14.33	HI93734-01	10.105, 10.114
HI900260	4.39, 4.57	HI921	4.32	HI935005	14.7	HI93734-03	10.105, 10.114
HI900270S	4.39, 4.57	HI921-100	4.32	HI935007	14.34	HI93735-00	10.71, 10.114
HI900280S	4.39	HI921-110	4.32	HI93501	14.28	HI93735-01	10.71, 10.114
HI900301	4.39	HI921-120	4.32	HI935012	14.26	HI93735-02	10.71, 10.114
HI900302	4.39	HI921-130	4.32	HI93510	14.20	HI93737-01	10.85, 10.114
HI900303	4.39	HI921-200	4.32	HI93510N	14.20	HI93737-03	10.85, 10.114
HI900304	4.39	HI921-210	4.32	HI93531	14.9	HI93738-01	10.59, 10.114
HI900310	4.39	HI921-220	4.32	HI93531N	14.9	HI93738-03	10.59, 10.114
HI900320	4.39	HI921-230	4.32	HI93700-01	10.54, 10.114	HI93739-01	10.69, 10.114
HI900511	4.28	HI92144	14.44	HI93700-03	10.54, 10.114	HI93739-03	10.69, 10.114
HI900512	4.28					HI93740-01	10.77, 10.114
HI900527	4.59					HI93740-03	10.77, 10.114
						HI93746-01	10.74, 10.95, 10.107
						HI93746-03	10.74, 10.107, 10.108



HI93748-01.....	10.75, 10.108, 10.114	HI96804.....	13.3	HI97726-11.....	10.77, 10.115	HI9810-61.....	7.56
HI93748-03.....	10.75, 10.108, 10.114	HI96811.....	13.8	HI97726C.....	10.77	HI98100.....	1.20
HI93749-01.....	10.64, 10.114	HI96812.....	13.8	HI97727.....	10.65	HI98100 (Checker Plus).....	1.21
HI93749-03.....	10.64, 10.114	HI96813.....	13.8	HI97727-11.....	10.65, 10.115	HI981004.....	1.22
HI93750-01.....	10.114	HI96814.....	13.8	HI97727C.....	10.65	HI981014.....	1.22
HI93750-03.....	10.114	HI96816.....	13.8	HI97728.....	10.78	HI98103.....	1.20, 1.21
HI93751-01.....	10.86, 10.114	HI96821.....	13.10	HI97728-11.....	10.78, 10.115	HI981030.....	1.24
HI93751-03.....	10.86, 10.114	HI96822.....	13.12	HI97728C.....	10.78	HI9810302 (HALO2).....	2.45
HI93752-01.....	10.109, 10.114	HI96831.....	13.14	HI97729.....	10.69	HI981031.....	1.32
HI93752-03.....	10.109, 10.114	HI96832.....	13.14	HI97729-11.....	10.69, 10.115	HI9810312 (HALO2).....	2.49
HI937520-01.....	10.109, 10.114	HI96841.....	13.7	HI97729C.....	10.69	HI981032.....	1.26
HI937520-03.....	10.109, 10.114	HI97101.....	10.95	HI97730.....	10.76	HI9810322 (HALO2).....	2.53
HI937521-01.....	10.109, 10.114	HI97101C.....	10.95	HI97730-11.....	10.76, 10.115	HI981033.....	1.31
HI937521-03.....	10.109, 10.114	HI97104.....	10.97	HI97730C.....	10.76	HI9810332 (HALO2).....	2.50
HI93753-01.....	10.58, 10.114	HI971044.....	10.97	HI97731.....	10.87	HI981034.....	1.25
HI93753-03.....	10.58, 10.114	HI971044C.....	10.97	HI97731-11.....	10.87, 10.115	HI9810342 (HALO2).....	2.52
HI93754.....	11.22	HI97104C.....	10.97	HI97731C.....	10.87	HI981035.....	1.27
HI93754-11.....	11.23	HI97105.....	10.93	HI97732.....	10.80	HI9810352 (HALO2).....	2.51
HI93754-12.....	11.23	HI97105-11.....	10.91, 10.93	HI97732-11.....	10.80, 10.115	HI981036.....	1.28
HI93754A-25.....	11.23	HI97106.....	11.20	HI97732C.....	10.80	HI9810362 (HALO2).....	2.54
HI93754B-25.....	11.23	HI97115.....	10.91	HI97733.....	10.55	HI981037.....	1.33
HI93754C-25.....	11.23	HI97115C.....	10.91	HI97733-11.....	10.55, 10.115	HI9810372 (HALO2).....	2.47
HI93754D-25.....	11.23	HI97115UC.....	10.91	HI97733C.....	10.55	HI981038.....	1.29
HI93754E-25.....	11.23	HI97500.....	14.46	HI97734.....	10.105	HI9810382 (HALO2).....	2.57
HI93754F-25.....	11.23	HI97700.....	10.54	HI97734-11.....	10.105	HI981039.....	1.30
HI93754G-25.....	11.23	HI97700-11.....	10.54, 10.115	HI97734C.....	10.105	HI9810392 (HALO2).....	2.55
HI93754J-25.....	11.23	HI97700C.....	10.54	HI97735.....	10.71	HI9810402 (HALO2).....	2.42
HI93755-01.....	10.114	HI97701.....	10.62	HI97735-11.....	10.71, 10.115	HI9810412 (HALO2).....	2.43
HI93755-03.....	10.114	HI97701-11.....	10.62	HI97735C.....	10.71	HI9810422 (HALO2).....	2.44
HI93755-53.....	10.97	HI97701C.....	10.62	HI97736.....	10.101	HI9810432 (HALO2).....	2.46
HI937554-53.....	10.123	HI97702.....	10.66	HI97736C.....	10.101	HI9810442 (HALO2).....	2.48
HI93757-01.....	10.114	HI97702-11.....	10.66, 10.115	HI97737.....	10.85	HI981045.....	1.28
HI93757-03.....	10.114	HI97702C.....	10.66	HI97737-11.....	10.85, 10.115	HI9810452.....	2.54
HI93758A-50.....	11.18	HI97704.....	10.72	HI97737C.....	10.85	HI98107 (pHep).....	1.17
HI93758B-50.....	11.18	HI97704-11.....	10.72, 10.115	HI97738.....	10.59	HI981074.....	1.18
HI93758C-50.....	11.18	HI97704C.....	10.72	HI97738-11.....	10.59, 10.115	HI98108.....	1.17
HI93763A-50.....	11.18	HI97705.....	10.84	HI97738C.....	10.59	HI9811-51.....	7.56
HI93763B-50.....	11.18	HI97705-11.....	10.84, 10.115	HI97739.....	10.69	HI98115.....	1.23
HI93767A-50.....	11.18	HI97705C.....	10.84	HI97739-11.....	10.69, 10.115	HI98118.....	1.19
HI93767B-50.....	11.18	HI97706.....	10.82	HI97739C.....	10.69	HI9812-51.....	7.56
HI943500A.....	15.76	HI97706-11.....	10.82, 10.115	HI97740.....	10.77	HI98120 (ORP).....	1.35
HI943500B.....	15.76	HI97706C.....	10.82	HI97740-11.....	10.77, 10.115	HI981204.....	1.36
HI943500C.....	15.76	HI97707.....	10.79	HI97740C.....	10.77	HI98121 (pH/ORP Combo).....	1.35
HI943500D.....	15.76	HI97707-11.....	10.79, 10.115	HI97741.....	10.107	HI981214.....	1.36
HI94754A-25.....	11.5	HI97707C.....	10.79	HI97741C.....	10.107	HI98127 (pHep 4).....	1.15
HI94754B-25.....	11.5	HI97708.....	10.79	HI97742.....	10.108	HI981274.....	1.16
HI94754C-25.....	11.5	HI97708-11.....	10.79, 10.115	HI97742-11.....	10.108, 10.115	HI98128 (pHep 5).....	1.15
HI94754D-25.....	11.5	HI97708C.....	10.79	HI97742C.....	10.108	HI98129 (Combo).....	1.8
HI94754E-25.....	11.5	HI97709.....	10.75	HI97745.....	10.111	HI9813-51.....	7.54
HI94754F-25.....	11.5	HI97709-11.....	10.75, 10.115	HI97745C.....	10.111	HI9813-61.....	7.54
HI94754G-25.....	11.5	HI97709C.....	10.75	HI97746.....	10.74	HI98130 (Combo).....	1.8
HI94758A-50.....	11.5	HI97710.....	10.103	HI97746-11.....	10.74, 10.95, 10.107, 10.111, 10.115	HI981304.....	1.12, 1.13
HI94758B-50.....	11.5	HI97710-11.....	10.95, 10.99	HI97746C.....	10.74	HI98131.....	1.10
HI94758C-50.....	11.5	HI97711.....	10.104	HI97747.....	10.66	HI9814.....	7.52
HI94763A-50.....	11.5	HI97711C.....	10.104	HI97747-11.....	10.66, 10.115	HI981412.....	15.34
HI94763B-50.....	11.5	HI97712.....	10.53	HI97747C.....	10.66	HI981412-00.....	15.34
HI94764A-25.....	11.5	HI97712-11.....	10.53, 10.115	HI97748.....	10.75	HI981412-10.....	15.34
HI94764B-25.....	11.5	HI97712C.....	10.53	HI97748-11.....	10.75, 10.108, 10.115	HI981412-20.....	15.34
HI94766-50.....	11.5	HI97713.....	10.81	HI97748C.....	10.75	HI981413.....	15.38
HI94767A-50.....	11.5	HI97713-11.....	10.81, 10.115	HI97749.....	10.64	HI981413-00.....	15.38
HI94767B-50.....	11.5	HI97713C.....	10.81	HI97749-11.....	10.64, 10.115	HI981413-10.....	15.38
HI9564.....	14.45	HI97714.....	10.67	HI97749C.....	10.64	HI981413-20.....	15.38
HI9565.....	14.45	HI97714-11.....	10.67, 10.115	HI97750.....	10.83	HI981420.....	1.58
HI95654.....	14.45	HI97714C.....	10.67	HI97750-11.....	10.115	HI981420-01.....	1.61
HI95747-01.....	10.66, 10.114	HI97715.....	10.54	HI97750C.....	10.83	HI981420-02.....	1.61
HI95747-03.....	10.66, 10.114	HI97715-11.....	10.54, 10.115	HI97751.....	10.86	HI981421.....	1.54
HI95761-01.....	10.63, 10.114	HI97715C.....	10.54	HI97751-11.....	10.86, 10.115	HI981421-01.....	1.57
HI95761-03.....	10.114	HI97716.....	10.57	HI97751C.....	10.86	HI981421-02.....	1.57
HI95762-01.....	10.61, 10.114	HI97716-11.....	10.57, 10.95, 10.115	HI97752.....	10.109	HI98143.....	15.101
HI95762-03.....	10.61, 10.63, 10.114	HI97716C.....	10.57	HI97752-11.....	10.109	HI98143-01.....	15.101
HI95769-01.....	10.114	HI97717.....	10.81	HI97752C.....	10.109	HI98143-04.....	15.101
HI95771-01.....	10.100, 10.114	HI97717-11.....	10.81, 10.115	HI97753.....	10.58	HI98143-20.....	15.101
HI95771-03.....	10.100, 10.114	HI97717C.....	10.81	HI97753-11.....	10.58, 10.115	HI98143-22.....	15.101
HI96770-01.....	10.84, 10.114	HI97718.....	10.73	HI97753C.....	10.58	HI981520.....	1.62
HI96770-03.....	10.84, 10.114	HI97718-11.....	10.73, 10.95, 10.115	HI97754.....	10.109	HI981520-01.....	1.65
HI96776-01.....	10.114	HI97718C.....	10.73	HI97754-11.....	10.109	HI981520-02.....	1.65
HI96776-03.....	10.114	HI97719.....	10.70	HI97761.....	10.63	HI98161.....	2.86
HI96777-01.....	10.114	HI97719-11.....	10.70, 10.101, 10.107	HI97761-11.....	10.63, 10.115	HI98162.....	2.90
HI96777-03.....	10.114	HI97719C.....	10.70	HI97761C.....	10.63	HI98163.....	2.94
HI96778-25.....	10.114	HI97720.....	10.70	HI97762.....	10.61	HI98164.....	2.98
HI96778-25.....	11.18	HI97720-11.....	10.70, 10.115	HI97762-11.....	10.61, 10.115	HI98165.....	2.102
HI96779-01.....	10.114	HI97720C.....	10.70	HI97762C.....	10.61	HI98167.....	2.106
HI96779-03.....	10.114	HI97721.....	10.74	HI97769.....	10.56	HI98168.....	2.114
HI96780-25.....	10.114	HI97721-11.....	10.74, 10.115	HI97769-11.....	10.115	HI98169.....	2.110, 2.112
HI96781-25.....	10.114	HI97721C.....	10.74	HI97770.....	10.84, 10.115	HI98190.....	2.82
HI96781-25.....	11.18	HI97722.....	10.68	HI97770-11.....	10.84, 10.115	HI98190-03.....	2.85
HI96782-25.....	10.114	HI97722-11.....	10.68, 10.95, 10.97	HI97770C.....	10.84	HI98191.....	3.16
HI96783-25.....	10.114	HI97722C.....	10.68	HI97771.....	10.100	HI98191-03.....	3.19
HI96784-25.....	10.114	HI97723.....	10.64	HI97771-11.....	10.100	HI981914.....	3.20
HI96785.....	10.112	HI97723-11.....	10.64, 10.115	HI97775.....	10.97	HI98192.....	5.26
HI96800.....	13.3	HI97723C.....	10.64	HI97775-11.....	10.97	HI98193.....	6.28
HI96801.....	13.3	HI97725.....	10.99	HI97779.....	10.60	HI98193/10.....	6.30
HI96802.....	13.3	HI97725C.....	10.99	HI97779-11.....	10.115	HI98194.....	7.34, 7.37
HI96803.....	13.3	HI97726.....	10.77	HI977794-11.....	10.97		

HI98194/10.....	7.37	HI98318.....	1.43
HI98194/20.....	7.37	HI98319.....	1.37
HI98194/40.....	7.37	HI98325.....	1.38
HI98195.....	7.38, 7.41	HI98326 (DiST 9).....	1.39
HI98195/10.....	7.41	HI98331 (Soil Test).....	1.45
HI98195/20.....	7.41	HI98494.....	7.2, 7.28, 7.33
HI98195/40.....	7.41	HI98494/10.....	7.33
HI981954.....	7.3, 7.42, 7.45	HI98494/20.....	7.33
HI98196.....	7.46, 7.49	HI98494/30.....	7.33
HI98196/10.....	7.49	HI98494/40.....	7.33
HI98196/20.....	7.49	HI98494/50.....	7.33
HI98196/40.....	7.49	HI98501 (Checktemp).....	1.50
HI98197.....	5.4, 5.29	HI98509 (Checktemp 1).....	1.51
HI98198.....	6.3, 6.24, 6.26	HI98539 (Checktemp Dip).....	1.52
HI98198/10.....	6.26	HI985394.....	1.52
HI98199.....	2.78	HI98703.....	12.14, 12.15
HI9828-25.....	7.26	HI98703-01.....	12.14, 12.15
HI9828-27.....	7.26	HI98703-02.....	12.14, 12.15
HI9829.....	7.3, 7.14	HI98703-11.....	12.24
HI9829-00041.....	7.24	HI98703-58.....	12.24, 12.25, 12.26
HI9829-00042.....	7.24	HI98713.....	12.17
HI9829-00101.....	7.24	HI98713-01.....	12.17
HI9829-00102.....	7.24	HI98713-02.....	12.17
HI9829-00201.....	7.24	HI98713-11.....	12.25
HI9829-00202.....	7.24	HI987134.....	12.17
HI9829-01041.....	7.24	HI987134-02.....	12.17
HI9829-01042.....	7.24	HI991001.....	2.120
HI9829-01101.....	7.24	HI991003.....	2.120
HI9829-01102.....	7.24	HI99111.....	2.134
HI9829-01201.....	7.24	HI99121.....	2.121
HI9829-01202.....	7.24	HI991300.....	7.50
HI9829-02041.....	7.25	HI991301.....	7.50
HI9829-02042.....	7.25	HI99131.....	2.122
HI9829-02101.....	7.25	HI99141.....	2.123
HI9829-02102.....	7.25	HI99151.....	2.132
HI9829-02201.....	7.25	HI99161.....	2.128
HI9829-02202.....	7.25	HI99162.....	2.125
HI9829-03041.....	7.25	HI99163.....	2.129
HI9829-03042.....	7.25	HI99164.....	2.126
HI9829-03101.....	7.25	HI99165.....	2.127
HI9829-03102.....	7.25	HI99171.....	2.124
HI9829-03201.....	7.25	HI99181.....	2.136
HI9829-03202.....	7.25	HI99192.....	2.130
HI9829-10041.....	7.24	HI99300.....	5.33
HI9829-10042.....	7.24	HI99301.....	5.33
HI9829-10101.....	7.24	PCA310.....	15.12
HI9829-10102.....	7.24	PCA310-1.....	15.12
HI9829-10201.....	7.24	PCA310-2.....	15.12
HI9829-10202.....	7.24	PCA320.....	15.12
HI9829-11041.....	7.24	PCA320-1.....	15.12
HI9829-11042.....	7.24	PCA320-2.....	15.12
HI9829-11101.....	7.24	PCA330.....	15.12
HI9829-11102.....	7.24	PCA330-1.....	15.12
HI9829-11201.....	7.24	PCA330-2.....	15.12
HI9829-11202.....	7.24	PCA340.....	15.12
HI9829-12041.....	7.25	PCA340-1.....	15.12
HI9829-12042.....	7.25	PCA340-2.....	15.12
HI9829-12101.....	7.25	pHep (HI98107).....	1.17
HI9829-12102.....	7.25	pHep 4 (HI98127).....	1.15
HI9829-12201.....	7.25	pHep 5 (HI98128).....	1.15
HI9829-12202.....	7.25	pHep+.....	1.17
HI9829-13041.....	7.25	Pronto (HI146-00).....	1.66
HI9829-13042.....	7.25	PWT (HI98308).....	1.47
HI9829-13101.....	7.25	Soil Test (HI98331).....	1.45
HI9829-13102.....	7.25	UPW (HI98309).....	1.47
HI9829-13201.....	7.25		
HI9829-13202.....	7.25		
HI9829-10.....	7.27		
HI9829-10/11.....	7.27		
HI9829-11.....	7.27		
HI9829-12.....	7.27		
HI9829-12/13.....	7.27		
HI9829-13.....	7.27		
HI9829-14.....	7.27		
HI9829-14/15.....	7.27		
HI9829-15.....	7.27		
HI9829-16.....	7.27		
HI9829-17.....	7.27		
HI9829-18.....	7.27		
HI98301.....	1.44		
HI98302.....	1.44		
HI983024.....	1.46		
HI98303.....	1.44		
HI98304.....	1.44		
HI983044.....	1.46		
HI98308 (PWT).....	1.47		
HI98309 (UPW).....	1.47		
HI98311 (DiST 5).....	1.41		
HI98312.....	1.41		
HI983124.....	1.42		

**Accessories**

Adapter, Cuvette, iris.....	10.20
Autosampler, Titration.....	4.58, 4.60
Bar, Measuring, Level Controller.....	15.95
Battery, Replaceable, AmpHel Electrodes.....	15.118
Beaker, 100 mL.....	10.27
Beaker, 170 mL.....	10.27
Beaker, Calibration, Long, Probes, HI9829.....	7.27
Beaker, Calibration, Short, Probes, HI9829.....	7.27
Boot, Portable, pH, HI8314 style.....	2.138
Boot, Portable, pH, HI8424 style.....	2.137
Boot, Portable, pH, HI98 Series.....	2.85, 2.88
Boot, Portable, pH, HI99 Series.....	2.120, 2.121
Boot, Portable, Thermometer, Foodcare HI935001 style.....	14.30
Boot, Blue, Portable, Thermometer, Foodcare HI93501 style.....	14.28
Cable, RS232, 5 to 9 Pin.....	12.24
Cable, USB to Micro USB.....	10.27
Cable, USB, Benchtop, HI83300 Series.....	10.27
Cable, USB, HI9829.....	7.27
Cable, USB, PC Connection.....	12.24
Cable, Extension, Electrodes, pH.....	2.170
Cable, Extension, Probes, Thermocouple, Foodcare.....	14.36
Cables, Extension, Probes, Thermocouple.....	14.36
Cap, Beaker, 100 mL.....	10.27
Cap, Smart, DO.....	6.34-6.35
Cap, Cuvettes, Photometers, Portable, Checker®HC.....	10.152
Cap, Long, Multi, Portable, HI9829.....	7.19, 7.27
Cap, Short, Multi, Portable, HI9829.....	7.18, 7.27
Cap, Saddle.....	15.25
Caps, Closing, Electrode Holder, PCA Series.....	12.24
Caps, Cuvettes, Large, Turbidity.....	12.24
Caps, Cuvettes, Photometers, Benchtop, HI83300 Series.....	10.27
Caps, Cuvettes, Photometers, Portable, HI97000 Series.....	10.52
Carrying Case, Photometers, Benchtop, HI83300 Series.....	10.27
Carrying Case, Photometers, Portable, HI97000 Series.....	10.52
Cloth, Cleaning.....	10.27
Cooling Rack, Test Tube, COD.....	11.24
Cuvettes, Large, Turbidity.....	12.24
Cuvettes, Photometers, Benchtop, HI83300 Series.....	10.27
Cuvettes, Photometers, Portable, Checker®HC.....	10.152
Cuvettes, Small, Turbidity.....	12.25
Diaphragm, Small, BL Pumps.....	15.105
Diaphragm, Titration, Karl Fischer Coulometric.....	4.28
Electrode Holder, Photometers, Benchtop, HI83300 Series.....	10.27
Electrode Sleeve, Protective.....	2.158
Filter, Aspiration, Pool Controller.....	15.25
Filter, Holmium (for iris).....	10.21
Filter, PCA Series.....	15.15
Flow-cell, UPW, Conductivity, Portable.....	5.31
Flow cell, Kit.....	15.25
Flow-cell, Valve.....	15.25
Flow-cell, Fittings Kit.....	15.25
Flow-cell, Injector Saddle.....	15.25
Flow-cell, Probe Saddle.....	15.25
Flow-cell, Quick Release, Multi, Portable, HI9829.....	7.16
Handle, Probes, Thermocouple, Foodcare.....	14.36
Handle, Probes, Thermocouple.....	14.36
Hanna Lab App.....	2.74-2.77
Heater, Test Tube, COD.....	11.24
Honey, Analysis Kit.....	10.112
Hose, LDPE, BL Pumps (BlackStone).....	15.107
iButton.....	7.20, 7.27, 12.13
Injector, Pool Controller.....	15.25
Ink Cartridge, Benchtop, pH.....	2.25

ISE Accessories.....	3.5, 3.30
Key, Calibration, Thermistor.....	14.21
Kit, Maintenance, Probe, HI9829.....	7.27
Kit, Sample Preparation, Photometers.....	10.27
Lamp, Replacement, Turbidity.....	12.24
Mounting, Panel-Mount Kit for HI510/HI520.....	15.53
Mounting, Wall-Mount Kit for HI510/HI520.....	15.54
Mounting, Pipe-Mount Kit for HI510/HI520.....	15.55
Membranes, Probes, DO.....	6.36-6.40
Motor, Stirring, PCS Series.....	15.15
Oil, Silicone.....	12.24
Paper Rolls, Benchtop, pH.....	2.25
Paper, Filter, Type II, Turbidity.....	12.26
Pipette, 100µL.....	10.127
Pipette, Automatic, 1000µL.....	11.19
Pipette, Automatic, 2000µL.....	11.19
Pipette, Automatic, 200µL.....	11.19
Pipette, Refilling.....	10.152
Pipette, Tips (200µL, 1000µL, 2000µL).....	11.19
Pumphead, BL Pumps (BlackStone).....	15.105, 15.107
Regulator, Incoming Pressure, PCA Series.....	15.15
Simulator for BL121.....	15.25
Shield, Heater, Test Tube, COD.....	11.24
Shield, Protective, Long, Probes, HI9829.....	7.27
Shield, Protective, Probes, DO.....	6.35, 6.38
Shield, Protective, Short, Probes, HI9829.....	7.27
Shield, Protective, Stainless Steel, Probes, opdo, DO.....	6.34-6.35
Smart Cap, Probes, DO.....	6.27, 6.35
Springs, PVDF, BL Pumps.....	15.107
Stir Bar, Micro.....	8.8
Stir Bar, PCA Series.....	15.15
Stir Bar.....	8.4
Syringe, 1 mL Graduated.....	10.152
Syringe, 5 mL Graduated.....	10.27
Syringe, 60 mL Graduated.....	10.27
Titration, Titration.....	4.39, 4.57-4.62
Tubing Kit, PCA Series.....	15.15
Tubing, Aspiration and Dispensing.....	15.25
Tubing, Flow-cell.....	15.25
Tubing, Peristaltic Pump.....	15.25
Valve, Foot Assembly, BL Pumps.....	15.105, 15.107
Valve, Injection Assembly, BL Pumps.....	15.105, 15.107
Valve, Suction Assembly, BL Pumps.....	15.105, 15.107
Vessel, Storage, Probes, DO.....	6.34-6.35
Vial, 25 mL, Turbidity.....	12.26
Water, Deionized.....	10.152
Weight, Ceramic, BL Pumps.....	15.105, 15.107

**Acidity**

Chemical Test Kits.....	9.10
Chemical Test Kits (Olive Oil).....	9.8
Solutions, Titration, Titratable.....	4.39
Solutions, Titration, Volatile.....	4.39

**Agriculture**

Solutions, Cleaning, pH and ORP Electrode.....	2.189
<i>also see Soil, GroLine, and Nutrients</i>	

**Algae, Fungi, and Bacteria**

Solutions, Cleaning, pH and ORP Electrode.....	2.189
--	-------

**Alkalinity**

Checker®HC (Freshwater).....	10.123
Checker®HC (Pool Line).....	10.123
Checker®HC (Seawater, Marine Line).....	10.123
Checker®HC (Seawater, dKH, Marine Line).....	10.123
Chemical Test Kits.....	9.10
Photometer, Benchtop, (Aquaculture).....	10.32
Photometer, Benchtop, (COD, Water and Wastewater).....	11.6
Photometer, Benchtop, (Lab).....	10.28
Photometer, Benchtop, (Pools and Spas).....	10.44
Photometer, Portable, (HI97 Series, Multi).....	10.88
Spectrophotometer (iris).....	10.8

**Alkalinity, Marine**

Photometer, Benchtop, (Aquaculture).....	10.32
Photometer, Benchtop, (Lab).....	10.28
Photometer, Benchtop, (COD, Water and Wastewater).....	11.6
Photometer, Portable, (HI97 Series, Multi, Marine Master).....	10.88, 10.92
Spectrophotometer (iris).....	10.8

**Aluminum**

Photometer, Benchtop, (Boilers and Cooling Towers).....	10.34
Photometer, Benchtop, (COD, Water and Wastewater).....	11.6
Photometer, Benchtop, (Lab).....	10.28
Photometer, Portable, (HI97 Series).....	10.53
Spectrophotometer (iris).....	10.8

**Ammonia**

Checker®HC.....	10.124, 10.125
Chemical Test Kits (Fresh Water).....	9.11
Chemical Test Kits (Seawater).....	9.11
Electrodes, ISE.....	3.22
Photometer, Benchtop, (Aquaculture).....	10.32
Photometer, Benchtop, (Boilers and Cooling Towers).....	10.34
Photometer, Benchtop, (COD, Barcode Recognition).....	11.4
Photometer, Benchtop, (COD, Water and Wastewater).....	11.6
Photometer, Benchtop, (COD, Wastewater).....	11.14
Photometer, Benchtop, (Environmental).....	10.36
Photometer, Benchtop, (Lab).....	10.28
Photometer, Benchtop, (Nutrient Analysis).....	10.38
Photometer, Benchtop, (Water Conditioning).....	10.46
Photometer, Portable, (HI97 Series, LR, MR).....	10.54
Photometer, Portable, (HI97 Series, HR).....	10.55
Spectrophotometer (iris).....	10.8

**Ammonia, Marine**

Checker®HC.....	10.124
Photometer, Portable, (HI97 Series, Multi, Marine Master).....	10.88, 10.92

**Anionic Surfactants**

*see Surfactants, Anionic*

**Aquaculture**

*see Marine and Marine Line*

**°Baumé**

Refractometer (Wine).....	13.8
---------------------------	------

**Beer Analysis**

Electrodes (Foodcare, Quick Connect).....	2.109, 2.133
HALO (Brewing).....	2.69
HALO2, pH (Beer).....	2.49
Portable, pH (HI98 Series, Foodcare).....	2.106
Portable, pH (HI99 Series, Foodcare).....	2.132-2.133
Refractometer, Portable, (°Plato).....	13.8
Solutions, Cleaning, pH and ORP Electrode (Brewing Deposits).....	2.189
Testers, pH (Foodcare Beer).....	1.32
Turbidity, Portable (Beer Haze).....	12.22

**Bleach**

*see Hypochlorite*

**Blood Products**

Solutions, Cleaning, pH and ORP Electrode.....	2.189
--	-------

**Brix**

Refractometer (Food).....	13.3
Refractometer (Wine).....	13.8
Refractometer, Liquid Chlorine (Pool Line).....	13.6

**Bread and Dough**

HALO2, pH (Bread & Dough).....	2.57
Solutions, Cleaning, pH and ORP Electrode.....	2.189
Testers, pH (Foodcare).....	1.29

**Bromine**

Checker®HC.....	10.126
Chemical Test Kits.....	9.12
Photometer, Benchtop, (Boilers and Cooling Towers).....	10.34
Photometer, Benchtop, (COD, Water and Wastewater).....	11.6
Photometer, Benchtop (Lab).....	10.28
Photometer, Benchtop (Pools and Spas).....	10.44
Photometer, Portable, (HI97 Series).....	10.57
Photometer, Portable, (HI97 Series, Multi).....	10.94
Turbidity, Portable (EPA, Multi).....	12.16
Spectrophotometer (iris).....	10.8

**Bromide**

Electrodes, ISE.....	3.22
----------------------	------

**Boilers**

Chemical Test Kits.....	9.32, 9.33
Photometer, Benchtop (Boilers and Cooling Towers).....	10.34
Portable (HI99 Series, Boiler and Cooling Towers).....	2.123

**Boron**

Chemical Test Kits.....	9.12
-------------------------	------

**Cadmium**

Electrodes, ISE.....	3.22
----------------------	------

**Calcium**

Electrodes, ISE.....	3.23
Photometer, Benchtop (Aquaculture).....	10.32
Photometer, Benchtop (COD, Water and Wastewater).....	11.6
Photometer, Benchtop (Lab).....	10.28
Photometer, Benchtop (Nutrient Analysis).....	10.38
Photometer, Portable (HI97 Series, Multi).....	10.109
Spectrophotometer (iris).....	10.8

**Calcium, Marine**

Checker®HC (Marine Line).....	10.127
Photometer, Benchtop (Aquaculture).....	10.32
Photometer, Benchtop (COD, Water and Wastewater).....	11.6
Photometer, Benchtop (Lab).....	10.28
Photometer, Portable, (HI97 Series, Multi, Marine Master).....	10.88, 10.92
Spectrophotometer (iris).....	10.8

**Carbon Dioxide**

Chemical Test Kits.....	9.13
Electrodes, ISE.....	3.23

**Cellulose**

Solutions, Cleaning, pH and ORP Electrode.....	2.189
--	-------

**Cheese Analysis**

Electrodes (Foodcare, Quick Connect).....	2.105, 2.167
HALO2, pH (Cheese).....	2.53
Portable, pH (HI98 Series, Foodcare).....	2.102
Portable, pH (HI99 Series, Foodcare).....	2.127
Portable, pH (HI99 Series, Foodcare Yogurt, Cheese, Semisolids).....	2.128
Solutions, Cleaning, pH and ORP Electrode.....	2.189
Testers, pH (Foodcare).....	1.26

**Chloride**

Checker®HC.....	10.128
Chemical Test Kits.....	9.13
Electrodes, ISE.....	3.23
Photometer, Benchtop (COD, Water and Wastewater).....	11.6
Photometer, Benchtop (Lab).....	10.28
Photometer, Portable, (HI97 Series).....	10.58
Spectrophotometer (iris).....	10.8

**Chlorine Dioxide**

Photometer, Benchtop (Boilers and Cooling Towers).....	10.34
Photometer, Benchtop (COD, Water and Wastewater).....	11.6
Photometer, Benchtop (Lab).....	10.28
Photometer, Portable (HI97 Series).....	10.59
Spectrophotometer (iris).....	10.8

**Chlorine Dioxide, Rapid Method**

Photometer, Benchtop (Boilers and Cooling Towers).....	10.34
Photometer, Benchtop (COD, Water and Wastewater).....	11.6
Photometer, Benchtop (Lab).....	10.28
Photometer, Benchtop (COD, Water and Wastewater).....	11.6
Photometer, Portable (HI97 Series).....	10.60
Spectrophotometer (iris).....	10.8

**Chlorine, Free**

Checker®HC.....	10.129
Checker®HC (Pool Line).....	10.129
Chemical Test Kits (Color Cube).....	9.14
Chemical Test Kits (LR, MR, Checker Disc).....	9.15
Chemical Test Kits (MR, Checker Disc).....	9.15
Photometer, Benchtop (COD, Barcode Recognition).....	11.4
Photometer, Benchtop (COD, Water and Wastewater).....	11.6
Photometer, Benchtop (COD, Wastewater).....	11.14
Photometer, Portable (HI97 Series, ULR).....	10.61
Photometer, Portable (HI97 Series).....	10.62
Photometer, Portable (HI97 Series, Multi).....	10.94, 10.88, 10.98, 10.100, 10.102, 10.104, 10.105, 10.110

**Chlorine, Free and Total**

Analyzer (PCA Series).....	15.10
Chemical Test Kits (LR, MR, Checker Disc).....	9.16
Chemical Test Kits (LR, MR, HR, Checker Disc).....	9.16
Photometer, Benchtop (Lab).....	10.28
Photometer, Benchtop (Aquaculture).....	10.32
Photometer, Benchtop (Boilers and Cooling Towers).....	10.34
Photometer, Benchtop (Environmental).....	10.36
Photometer, Benchtop (Pools and Spas).....	10.44
Photometer, Benchtop (Water Conditioning).....	10.46
Photometer, Portable (HI97 Series, Multi).....	10.94, 10.88, 10.98, 10.100, 10.102, 10.104, 10.105, 10.110
Turbidity, Benchtop (EPA, Multi).....	12.6, 12.16
Turbidity, Portable (EPA, Multi, FastTracker™).....	12.12
Spectrophotometer (iris).....	10.8

**Chlorine, Total**

Checker®HC.....	10.130
Chemical Test Kits (Color Cube).....	9.17
Chemical Test Kits (Extended Range).....	9.17
Photometer, Benchtop (COD, Wastewater).....	11.14
Photometer, Benchtop (COD, Water and Wastewater).....	11.6
Photometer, Portable, (HI97 Series).....	10.63
Photometer, Portable (HI97 Series, Multi).....	10.94, 10.88, 10.98, 10.100, 10.102, 10.104, 10.105, 10.110

**Chocolate**

HALO2, pH (Chocolate).....	2.55
Solutions, Cleaning, pH and ORP Electrode.....	2.189
Testers, pH (Foodcare).....	1.30

**Chromium (VI)**

Checker®HC.....	10.131
Chemical Test Kits.....	9.18
Photometer, Benchtop (Boilers and Cooling Towers).....	10.34
Photometer, Benchtop (COD, Water and Wastewater).....	11.6
Photometer, Benchtop (Environmental).....	10.36
Photometer, Benchtop (Lab).....	10.28
Photometer, Portable, (HI97 Series).....	10.64
Spectrophotometer (iris).....	10.8

**Chemical Oxygen Demand (COD)**

Accessories, Photometer, Benchtop.....	11.19
Photometer, Benchtop (Barcode Recognition).....	11.4
Photometer, Benchtop (Wastewater).....	11.14
Photometer, Benchtop (Water and Wastewater).....	11.6
Photometer, Portable.....	11.20
Reagents (HI83224).....	11.5
Reagents (Certified Standards and Reagents).....	11.22
Reagents, Wastewater Testing.....	11.18
Spectrophotometer (iris).....	10.8

**Color of Water**

Checker®HC.....	10.132
Photometer, Benchtop, (COD, Water and Wastewater).....	11.6
Photometer, Benchtop, (Environmental).....	10.36
Photometer, Portable (HI97 Series).....	10.65
Photometer, Benchtop, (Lab).....	10.28
Spectrophotometer (iris).....	10.8

**Conductivity**

Benchtop, Advanced Conductivity/Resistivity/ TDS/Salinity.....	5.6
Benchtop (edge®EC).....	5.22
Benchtop (edge®pH•EC•DO).....	2.26
Benchtop (Research Grade).....	5.16, 7.4, 7.10
Controller, Mini (mS/cm).....	15.86
Controller, Mini (µS/cm).....	15.85
Controller, Panel-Mount (Analog, Potentiometric).....	15.76
Controller, Panel-Mount (Analog).....	15.75
Dosing System, Nutrient (GroLine).....	15.36
Fertigation Control System.....	15.6
Monitor (GroLine, In-line).....	15.4
Monitor (GroLine).....	15.8
Multiparameter, Portable (HI98194).....	7.34
Multiparameter, Portable (HI98195).....	7.38
Multiparameter, Portable (HI98494).....	7.28
Multiparameter, Portable (Pool Line, HI981954).....	7.42
Portable (99 Series, Multiparameter).....	7.50
Portable (99 Series).....	5.33
Portable (GroLine, Multiparameter).....	7.52
Portable (HI98199, pH, EC, DO).....	2.78
Portable (HI9829, Multiparameter).....	7.14
Portable (Multi-Range, MTC, ATC).....	5.34
Portable (Multiparameter, CAL Check™).....	7.54
Portable (Multiparameter).....	7.56
Portable (Pool Line Multiparameter).....	7.42
Portable (Ultrapure Water).....	5.29
Portable (Waterproof, Rugged).....	5.26
Probe (HI510/HI520 Compatible).....	15.62-15.63
Probes (Mini Controllers).....	15.90
Probe, Flow-Thru.....	15.129
Probe, In-line.....	15.128
Probe, Submersion.....	15.129
Solutions, Calibration.....	5.36-5.40
Solutions, Calibration (GroLine Quick Cal).....	5.42
Testers (Combo).....	1.8
Testers (DIST®3, DIST®4).....	1.44
Testers (DIST®5, DIST®6).....	1.40
Testers (GroLine Combo).....	1.10
Testers (GroLine Soil Test).....	1.45
Testers (GroLine).....	1.43
Testers (Pool Line Combo).....	1.12
Testers (Pool Line).....	1.42
Testers (PWT).....	1.47
Testers (UPW).....	1.47
Transmitter.....	15.93, 15.95

**Copper**

Checker®HC.....	10.135
Checker®HC (Pool Line).....	10.135
Chemical Test Kits.....	9.18
Photometer, Benchtop (Aquaculture).....	10.32

Photometer, Benchtop (Boilers and Cooling Towers).....	10.34	ORP, Easy.....	15.123	Testers, pH (Foodcare Beer).....	1.32
Photometer, Benchtop (COD, Water and Wastewater).....	11.6	ORP, Flow-Thru.....	15.120-15.122	Testers, pH (Foodcare Bread).....	1.29
Photometer, Benchtop (Environmental).....	10.36	ORP, Flat-Tip Industrial.....	15.115	Testers, pH (Foodcare Chocolate).....	1.30
Photometer, Benchtop (Lab).....	10.28	ORP, Flat-Tip Industrial (AmpHel).....	15.116	Testers, pH (Foodcare Cheese).....	1.26
Photometer, Benchtop (Pools and Spas).....	10.44	ORP, Industrial.....	15.127	Testers, pH (Foodcare Meat).....	1.28
Photometer, Benchtop (Water Conditioning).....	10.46	ORP, T-Type.....	15.126	Testers, pH (Foodcare Milk).....	1.25
Photometer, Portable, (HI97 Series).....	10.66	ISE.....	3.22-3.27	Testers, pH (Foodcare Sushi).....	1.27
Spectrophotometer (Iris).....	10.8	ISE, Reference.....	3.27	Testers, pH (Foodcare Wine).....	1.31
<b>Cooling Towers</b>		Photometric.....	4.30	Thermometers and Probes.....	14.26-14.40
Photometer, Benchtop.....	10.34	Reference.....	2.172		
Portable, pH (HI99 Series).....	2.123	Testers, Replacement.....	1.68-1.70		
		Titration, Polarization.....	4.25		
<b>Creams, Cosmetic</b>		<b>Electrode Holders</b>		<b>Formaldehyde</b>	
HALO2, pH (Cosmetic Creams).....	2.46	By-pass Loop.....	15.131	Chemical Test Kits.....	9.19
<b>Cupric</b>		Immersion.....	15.134		
Electrodes, ISE.....	3.24	Inline.....	15.130, 15.133	<b>Fructose</b>	
<b>Cyanide</b>		PCA Series.....	15.15	Refractometer (Food).....	13.3
Electrodes, ISE.....	3.24	Submersible.....	15.132		
Photometer, Portable, (HI97 Series).....	10.67	<b>Electrode Protective Sleeve</b>		<b>Glucose</b>	
Spectrophotometer (Iris).....	10.8	Electrode Sleeve, Protective.....	2.158	Refractometer (Food).....	13.3
<b>Cyanuric Acid</b>		<b>Environmental</b>		<b>Glycol</b>	
Photometer, Benchtop (COD, Water and Wastewater).....	11.6	Benchtop, Photometers.....	10.36	Chemical Test Kits.....	9.19
Photometer, Benchtop (Environmental).....	10.36	Chemical Test Kits.....	9.34	Refractometer (Ethylene).....	13.14
Photometer, Benchtop (Lab).....	10.28	<b>Feedwater</b>		Refractometer (Propylene).....	13.14
Photometer, Benchtop (Pools and Spas).....	10.44	Chemical Test Kits.....	9.32		
Photometer, Portable, (HI97 Series).....	10.68	<b>Fertigation Control</b>		<b>GPS</b>	
Photometer, Portable (HI97 Series, Multi).....	10.94, 10.88, 10.98	Fertigation Control System.....	15.6	Portable, GPS Multiparameter, HI9829.....	7.14
Spectrophotometer (Iris).....	10.8	<b>Fluoride</b>		<b>GroLine</b>	
Turbidity, Portable (EPA, Multi).....	12.16	Checker®HC.....	10.136	Dosing System, pH (GroLine).....	15.32
<b>Dairy</b>		Electrodes, ISE.....	3.25	Dosing System, Nutrient (GroLine).....	15.36
Titrator, Benchtop, Titratable Acidity (Dairy).....	4.46	Photometer, Benchtop, (COD, Water and Wastewater).....	11.6	Monitor (GroLine, In-line).....	1.54
Solutions, Cleaning, pH and ORP Electrode.....	2.189	Photometer, Benchtop (Lab).....	10.28	Monitor (GroLine).....	1.58
<b>Dewpoint</b>		Photometer, Benchtop (Water Conditioning).....	10.46	Portable (GroLine, Multiparameter).....	7.52
Portable, Thermo-Hygrometer.....	14.45	Photometer, Portable, (HI97 Series).....	10.69	Portable (Pool Line Multiparameter).....	7.42
<b>Dissolved Oxygen</b>		Spectrophotometer (Iris).....	10.8	Portable, pH (GroLine Soil).....	2.114
see oxygen, dissolved		<b>Foodcare</b>		Probe, pH (Direct Soil for HI9814, Quick Connect).....	7.53
<b>Dosing</b>		Electrodes, pH.....	2.164-2.167	Solutions, Cleaning.....	2.189
Pumps (BlackStone).....	15.98-15.99	Electrodes, pH (Foodcare General, Quick Connect).....	2.89	Solutions, EC.....	5.37-5.42
<b>EC</b>		Electrodes, pH (Foodcare Milk, Quick Connect).....	2.93	Solutions, Gelled Bridge Electrolyte.....	2.190
see Conductivity		HALO, pH (Brewing).....	2.69	Solutions, pH.....	2.181-2.184
<b>Education</b>		HALO, pH (Food).....	2.65, 2.73	Solutions, Storage.....	2.187
Chemical Test Kits (Backpack Lab®, Aquaculture).....	9.42	HALO, pH (Wine).....	2.67	Solutions, Quick Cal.....	2.181
Chemical Test Kits (Backpack Lab®, Soil).....	9.40	HALO2, pH (Beer).....	2.49	Testers (GroLine Combo).....	1.10
Chemical Test Kits (Backpack Lab®, Water).....	9.38	HALO2, pH (Bread & Dough).....	2.57	Testers, EC (GroLine).....	1.43
<b>Electrodes (see also Probes and Sensors)</b>		HALO2, pH (Cheese).....	2.53	Testers, EC (GroLine Soiltest).....	1.45
pH, AmpHel.....	15.118	HALO2, pH (Chocolate).....	2.55	Testers, pH (GroLine).....	1.19, 1.23
pH Combination.....	2.154-2.157	HALO2, pH (Meat).....	2.54	Testers, pH (GroLine Soil).....	1.24
pH, Easy.....	15.124	HALO2, pH (Milk).....	2.52	Testers, Salinity (GroLine).....	1.38
pH, Flat-Tip Industrial.....	15.114	HALO2, pH (Sushi).....	2.51	Testers, Replacement Probes.....	1.68-1.70
pH, Flat-Tip Industrial (AmpHel).....	15.116	HALO2, pH (Wine, Must, Juice).....	2.50		
pH, Flow-Thru.....	15.120-15.122	Portable, pH (HI99 Series, Beer).....	2.132-2.133	<b>HALO®.....</b>	<b>2.58-2.73</b>
pH, Industrial.....	15.127	Portable, pH (HI99 Series, Cheese).....	2.127	HALO, pH (Brewing).....	2.69
pH, In-line.....	15.127	Portable, pH (HI99 Series, Drinking Water).....	2.130	HALO, pH (Field).....	2.64
pH, Submersible.....	15.127	Portable, pH (HI99 Series, Meat).....	2.129	HALO, pH (Flat Surfaces).....	2.72
pH, T-Type.....	15.125	Portable, pH (HI99 Series, Milk).....	2.125	HALO, pH (Food).....	2.65, 2.73
pH and ORP, Digital.....	2.161-2.163	Portable, pH (HI99 Series, Wine).....	2.134	HALO, pH (Lab).....	2.60
pH and ORP Electrode Extension Cables.....	2.170	Portable, pH (HI99 Series, Yogurt).....	2.126	HALO, pH (Lab, edge®blu).....	2.61
pH and ORP, Foodcare.....	2.164-2.167	Portable, pH (HI99 Series, Yogurt, Cheese, Semisolids).....	2.128	HALO, pH (Lab, Small Samples).....	2.63
pH and ORP Half-Cells.....	2.171	Portable, pH (HI98 Series, Beer).....	2.106	HALO, pH (Soil, Direct).....	2.71
pH and ORP, Rugged.....	2.160	Portable (HI98 Series, Foodcare Cheese).....	2.102	HALO, pH (Test Tubes).....	2.62
pH and ORP, Special.....	2.158	Portable (HI98 Series, Foodcare, General).....	2.86	HALO, pH (Wine, Must, Juice).....	2.67
pH and ORP, Specific Analysis.....	2.168-2.170	Portable (HI98 Series, Foodcare, Meat).....	2.94		
ORP, AmpHel.....	15.118	Portable, pH (HI98 Series, Milk).....	2.90	<b>HALO2.....</b>	<b>2.40-2.57</b>
		Portable, pH (HI98 Series, Yogurt).....	2.98	HALO2, pH (Beer).....	2.49
		Portable, pH (HI98 Series, Wine).....	2.110	HALO2, pH (Bread & Dough).....	2.57
		Portable, Thermometer, Thermistor (Brewing).....	14.26	HALO2, pH (Cheese).....	2.53
		Refractometer (Food).....	13.10	HALO2, pH (Cosmetic Creams).....	2.46
		Solutions, Cleaning, pH and ORP Electrode.....	2.189	HALO2, pH (Chocolate).....	2.55
				HALO2, pH (Field).....	2.44
				HALO2, pH (Lab, General Purpose).....	2.42, 2.43
				HALO2, pH (Leather & Paper).....	2.48
				HALO2, pH (Meat).....	2.54
				HALO2, pH (Milk).....	2.52
				HALO2, pH (Skincare).....	2.47
				HALO2, pH (Soil).....	2.45
				HALO2, pH (Sushi).....	2.51
				HALO2, pH (Wine, Must, Juice).....	2.50

<b>Hanna Cloud</b> .....	15.18-15.19	Photometer, Benchtop (Lab).....	10.28	<b>Lux</b>	
<b>Hanna Lab App</b> .....	2.74-2.77, 7.30	Photometer, Portable, (HI97 Series).....	10.73	Portable.....	14.46
<b>Hardness, Calcium</b>		Spectrophotometer (iris).....	10.8	<b>Magnesium</b>	
Checker®HC.....	10.138	Turbidity, Portable (EPA, Multi).....	12.16	Photometer, Benchtop (COD, Water and Wastewater).....	11.6
Photometer, Benchtop (COD, Water and Wastewater).....	11.6	<b>Iron (II) (Ferrous)</b>		Photometer, Benchtop (Lab).....	10.28
Photometer, Benchtop (Lab).....	10.28	Photometer, Benchtop (Boilers and Cooling Towers).....	10.34	Photometer, Benchtop (Nutrient Analysis).....	10.38
Photometer, Benchtop, (Pools and Spas).....	10.44	Photometer, Benchtop (COD, Water and Wastewater).....	11.6	Photometer, Portable (HI97 Series, Multi).....	10.109
Photometer, Portable, (HI97 Series).....	10.70	Photometer, Benchtop (Lab).....	10.28	Spectrophotometer (iris).....	10.8
Spectrophotometer (iris).....	10.8	<b>Iron (II &amp; III) (Ferrous and Ferric)</b>		<b>Magnesium, Marine</b>	
<b>Hardness, Magnesium</b>		Photometer, Benchtop (COD, Water and Wastewater).....	11.6	Checker®HC.....	10.133
Checker®HC.....	10.138	Photometer, Benchtop (Lab).....	10.28	Photometer, Portable, (HI97 Series, Multi, Marine Master).....	10.88, 10.92
Photometer, Benchtop (COD, Water and Wastewater).....	11.6	<b>Iron</b>		<b>Manganese</b>	
Photometer, Benchtop (Lab).....	10.28	Checker®HC.....	10.140	Checker®HC.....	10.141
Photometer, Portable, (HI97 Series).....	10.70	Chemical Test Kits (HR, Checker®Disc).....	9.24	Photometer, Benchtop (COD, Water and Wastewater).....	11.6
Spectrophotometer (iris).....	10.8	Chemical Test Kits (LR, Checker®Disc).....	9.23	Photometer, Portable, (HI97 Series).....	10.75
<b>Hardness, Total</b>		Chemical Test Kits (MR, Checker®Disc).....	9.24	Photometer, Portable (HI97 Series, Multi).....	10.108
Checker®HC.....	10.137	Chemical Test Kits (MR, Color Cube).....	9.23	Photometer, Benchtop (Lab).....	10.28
Chemical Test Kits.....	9.20	Photometer, Benchtop (Boilers and Cooling Towers).....	10.34	Photometer, Benchtop (Water Conditioning).....	10.46
Chemical Test Kits (HR).....	9.21	Photometer, Benchtop (COD, Wastewater).....	11.14	Spectrophotometer (iris).....	10.8
Chemical Test Kits (LR).....	9.21	Photometer, Benchtop (COD, Water and Wastewater).....	11.6	<b>Maple Syrup</b>	
Chemical Test Kits (MR).....	9.21	Photometer, Benchtop (Lab).....	10.28	Checker®HC.....	10.134
Chemical Test Kits (Pool Line).....	9.20	Photometer, Benchtop (Pools and Spas).....	10.44	Spectrophotometer (iris).....	10.8
Photometer, Benchtop (COD, Water and Wastewater).....	11.6	Photometer, Benchtop (Water Conditioning).....	10.46	<b>Marine and Marine Line</b>	
Photometer, Benchtop (Lab).....	10.28	Photometer, Portable (HI97 Series, HR).....	10.74	Checker®HC (Alkalinity, Seawater).....	10.123
Photometer, Portable, (HI97 Series).....	10.71	Photometer, Portable, (HI97 Series, LR).....	10.74	Checker®HC (Alkalinity, Seawater, dKH).....	10.123
Photometer, Portable (HI97 Series, Multi).....	10.101, 10.106, 10.110	Photometer, Portable (HI97 Series, Multi LR).....	10.94	Checker®HC (Ammonia).....	10.124
Spectrophotometer (iris).....	10.8	Photometer, Portable (HI97 Series, Multi).....	10.106	Checker®HC (Calcium).....	10.127
<b>Heating</b>		Photometer, Portable (HI97 Series, Multi).....	10.108	Checker®HC (Magnesium).....	10.133
Test Tube Heater (for COD).....	11.24	Photometer, Portable (HI97 Series, Multi).....	10.110	Checker®HC (Nitrate LR).....	10.143
<b>Honey</b>		Spectrophotometer (iris).....	10.8	Checker®HC (Nitrate HR).....	10.144
Photometer, Portable (HI96 Series).....	10.112	Turbidity, Portable (EPA, Multi).....	12.16	Checker®HC (Nitrite ULR).....	10.146
<b>Humidity</b>		<b>Ink</b>		Checker®HC (Nitrite LR).....	10.146
see <i>Relative Humidity</i>		Solutions, pH and ORP Electrode Cleaning (Ink Stains).....	2.189	Checker®HC (pH).....	10.147
<b>Humus</b>		<b>Irrigation Control</b>		Checker®HC (Phosphate ULR).....	10.149
Solutions, Cleaning, pH and ORP Electrode.....	2.189	Fertigation Control System.....	15.6	Checker®HC (Phosphorus ULR).....	10.150
<b>Hydrazine</b>		<b>ISE</b>		Chemical Test Kits.....	9.33
Photometer, Benchtop (Boilers and Cooling Towers).....	10.34	Benchtop (Research Grade).....	3.6	Chemical Test Kits (Backpack Lab®).....	9.42
Photometer, Benchtop (COD, Water and Wastewater).....	11.6	Benchtop (Research Grade).....	3.12	Monitor (Marine Monitor, Multi).....	1.62
Photometer, Benchtop (Lab).....	10.28	Electrodes.....	3.22-3.27	Photometer, Benchtop (Aquaculture).....	10.32
Photometer, Portable, (HI97 Series).....	10.72	Electrodes, Reference.....	3.27	Photometer, Portable, (HI97 Series, Multi, Marine Master).....	10.88, 10.92
Spectrophotometer (iris).....	10.8	Portable (HI9829, Multiparameter).....	7.14	Refractometer (Aquaculture).....	13.12
<b>Hydrogen Peroxide</b>		Portable (Pool Line Waterproof, Rugged).....	3.20	Testers, Salinity.....	1.37
Chemical Test Kits.....	9.22	Portable (Waterproof, Rugged).....	3.16	Spectrophotometer (iris).....	10.8
Chemical Test Kits (Pool Line).....	9.22	Solutions, Gas Sensor Fill.....	3.28	<b>Meat Analysis</b>	
<b>Hydroponics</b>		Solutions, Ionic Strength Adjusters (ISA).....	3.29	Electrodes (Foodcare, Quick Connect).....	2.97, 2.165, 2.167
See <i>GroLine</i>		Solutions, Reference Fill.....	3.29	HALO2, pH (Meat).....	2.54
<b>Hypochlorite</b>		Solutions, Specific.....	3.28	Portable, pH (Foodcare).....	2.94
Chemical Test Kits.....	9.22	Sodium Standards.....	3.29	Portable, pH (HI99 Series).....	2.129
Chemical Test Kits (Pool Line).....	9.22	Standards.....	3.28	Testers, pH (Foodcare).....	1.28
<b>Industrial Processes</b>		Standards, Fluoride.....	3.30	Solutions, Cleaning, pH and ORP Electrode.....	2.189
Solutions, Cleaning, pH and ORP Electrode.....	2.189	Standards, Sodium Chloride.....	3.30	<b>Milk Analysis</b>	
<b>Invert Sugar</b>		<b>*KMW</b>		Electrodes, pH (Foodcare, Quick Connect) ...	2.93, 2.164
Refractometer (Food).....	13.3	Portable, Refractometer (Wine).....	13.8	HALO2, pH (Milk).....	2.52
<b>Iodide</b>		<b>Lead</b>		Portable, pH (Foodcare).....	2.90
Electrodes, ISE.....	3.25	Electrodes, ISE.....	3.26	Portable, pH (HI99 Series, Foodcare, Milk).....	2.125
<b>Iodine</b>		<b>Leather</b>		Solutions, Cleaning, pH and ORP Electrode.....	2.189
Checker®HC.....	10.139	HALO2, pH (Leather & Paper).....	2.48	Testers, pH (Foodcare).....	1.25
Photometer, Benchtop (COD, Water and Wastewater).....	11.6	Portable (99 Series).....	2.124	<b>Molybdenum</b>	
		<b>Level</b>		Photometer, Benchtop (Boilers and Cooling Towers).....	10.34
		Controller, Mini.....	15.94	Photometer, Benchtop (Environmental).....	10.36
		Transmitter.....	15.95	Photometer, Benchtop (Lab).....	10.28
				Photometer, Benchtop (Water Conditioning).....	10.46
				Photometer, Portable, (HI97 Series).....	10.76
				Spectrophotometer (iris).....	10.8

<b>mV</b>	Portable (Analog).....	2.138
<b>nD</b>	Refractometer (Food).....	13.3
<b>Nickel</b>	Checker®HC.....	10.142
	Photometer, Benchtop (COD, Water and Wastewater).....	11.6
	Photometer, Benchtop (Environmental).....	10.36
	Photometer, Benchtop (Lab).....	10.28
	Photometer, Benchtop (Water Conditioning).....	10.46
	Photometer, Portable, (HI97 Series).....	10.77
	Spectrophotometer (iris).....	10.8
<b>Nitrate</b>	Electrodes, ISE.....	3.26
	Checker®HC (Marine Line, Nitrate LR).....	10.143
	Checker®HC (Marine Line, Nitrate HR).....	10.144
	Chemical Test Kits.....	9.25
	Chemical Test Kits (Soil and Irrigation Water).....	9.25
	Photometer, Benchtop (Aquaculture).....	10.32
	Photometer, Benchtop (Boilers and Cooling Towers).....	10.34
	Photometer, Benchtop (COD, Barcode Recognition).....	11.4
	Photometer, Benchtop (COD, Wastewater).....	11.14
	Photometer, Benchtop (COD, Water and Wastewater).....	11.6
	Photometer, Benchtop (Lab).....	10.28
	Photometer, Benchtop (Environmental).....	10.36
	Photometer, Benchtop (Nutrient Analysis).....	10.38
	Photometer, Benchtop (Pools and Spas).....	10.44
	Photometer, Benchtop (Water Conditioning).....	10.46
	Photometer, Portable (HI97 Series).....	10.78
	Photometer, Portable, (HI97 Series, Multi, Marine Master).....	10.88, 10.92
	Spectrophotometer (iris).....	10.8
<b>Nitrite</b>	Checker®HC.....	10.145
	Checker®HC (Marine Line).....	10.146
	Chemical Test Kits.....	9.26
	Photometer, Benchtop (Aquaculture).....	10.32
	Photometer, Benchtop (Boilers and Cooling Towers).....	10.34
	Photometer, Benchtop (COD, Wastewater).....	11.14
	Photometer, Benchtop (COD, Water and Wastewater).....	11.6
	Photometer, Benchtop (Environmental).....	10.36
	Photometer, Benchtop (Lab).....	10.28
	Photometer, Portable, (HI97 Series).....	10.79
	Spectrophotometer (iris).....	10.8
<b>Nitrite, Marine</b>	Checker®HC (Marine Line).....	10.146
	Photometer, Benchtop (COD, Wastewater).....	11.14
	Photometer, Benchtop (COD, Water and Wastewater).....	11.6
	Photometer, Benchtop (Lab).....	10.28
	Photometer, Portable, (HI97 Series, Multi, Marine Master).....	10.88, 10.92
	Spectrophotometer (iris).....	10.8
<b>Nitrogen</b>	Chemical Test Kits (Quick Soil).....	9.31
	Chemical Test Kits (Soil).....	9.31
<b>Nitrogen, Total</b>	Photometer, Benchtop (COD, Barcode Recognition).....	11.4
	Photometer, Benchtop (COD, Wastewater).....	11.14
	Photometer, Benchtop (COD, Water and Wastewater).....	11.6
	Spectrophotometer (iris).....	10.8
<b>Nutrients</b>	Photometer, Benchtop (Nutrient Analysis).....	10.38
	Lysimeter.....	10.40
<b>°Oechsle</b>	Refractometer (Wine).....	13.8
<b>Olive Oil</b>	Chemical Test Kits (Acidity).....	9.8
	Photometer, Portable (Peroxide Value).....	10.120
<b>ORP</b>	Analyzer (PCA Series).....	15.10
	Benchtop, Advanced pH/ORP.....	2.8
	Benchtop (edge®pH).....	2.30
	Benchtop (Research Grade).....	2.18, 2.22, 7.4, 7.10
	Benchtop (Built-in Printer).....	2.24
	Controllers, Universal Process.....	15.48
	Controller, Mini.....	15.82.
	Controller, Mini (Recorder Output).....	15.83
	Controller, Panel-Mount (Analog).....	15.73
	Controller (Pool Line).....	15.16, 15.26
	Controller and Dosing Pump (Pool Line).....	15.44
	Controller/Pump (BlackStone).....	15.99
	Electrodes, AmpHel.....	15.119
	Electrodes, Easy.....	15.123
	Electrodes, Flat-Tip Industrial.....	15.115
	Electrodes, Flat-Tip Industrial (AmpHel).....	15.116
	Electrodes, Flow-Thru.....	15.120-15.122
	Electrodes, Industrial.....	15.127
	Electrodes, pH and ORP, Special.....	2.158
	Electrodes, pH and ORP, Rugged.....	2.160
	Electrodes, pH and ORP, Digital.....	2.163
	Electrodes, pH and ORP, Foodcare.....	2.167
	Electrodes, pH and ORP, Specific Analysis.....	2.169
	Electrodes, pH and ORP, Extension Cables.....	2.170
	Electrodes, pH and ORP Half-Cells.....	2.171
	Electrodes, T-Type.....	15.126
	Indicator, Panel-Mount (Analog).....	15.74
	Multiparameter, Portable (HI9829).....	7.14
	Multiparameter, Portable (HI98494).....	7.28
	Multiparameter, Portable (HI98194).....	7.34
	Multiparameter, Portable (HI98195).....	7.38
	Multiparameter, Portable (Pool Line, HI981954).....	7.42
	Multiparameter, Portable (HI98196).....	7.46
	Portable (Analog).....	2.138
	Portable (HI99 Series).....	2.120
	Portable (Pool Line Waterproof, Rugged).....	3.20
	Portable (Precision Simulator).....	2.139
	Portable (Waterproof, Rugged).....	3.16
	Portable (Waterproof, Rugged)(HI98190).....	2.82
	Probe (HI510/HI520 Compatible).....	15.57
	Solutions, Test and Pretreatment.....	2.186
	Testers (Combo, ORP).....	1.34
	Testers (Pool Line Combo, ORP).....	1.36
	Transmitter.....	15.102
<b>Oxygen, Dissolved</b>	Accessories, Smart Cap (Optical Probe).....	6.27, 6.34-6.35
	Accessories, Probe Membranes.....	6.36-6.40
	Benchtop, Advanced Optical and Polarographic.....	6.4
	Benchtop (edge®DO).....	6.20
	Benchtop (edge®pH•EC•DO).....	6.16
	Benchtop (Research Grade).....	6.14
	Chemical Test Kits.....	9.26
	Controller, Panel-Mount (Analog).....	15.77
	Photometer, Benchtop, (Aquaculture).....	10.32
	Photometer, Benchtop, (Lab).....	10.26
	Photometer, Benchtop, (Boilers and Cooling Towers).....	10.34
	Photometer, Benchtop, (Environmental).....	10.36
	Photometer, Benchtop (Water Conditioning).....	10.46
	Photometer, Benchtop (COD, Water and Wastewater).....	11.6
	Photometer, Portable, (HI97 Series).....	10.80
	Portable.....	6.32
	Portable (Aquaculture, Galvanic).....	6.31
	Portable (HI98199, pH, EC, DO).....	2.78
	Portable(Manual Calibration).....	6.33
	Portable, Multiparameter (HI9829).....	7.14
	Portable, Multiparameter (HI98194).....	7.34
	Portable, Multiparameter (HI98196).....	7.46
	Portable (opdo™, Optical).....	6.24
	Portable (Waterproof, Rugged).....	6.28
	Probes, Digital (edge® Compatible).....	6.36
	Probes, Galvanic.....	6.39
	Probe, Galvanic (HI510/HI520 Compatible).....	15.64
	Probes, Optical (opdo).....	6.27, 6.34
	Probe, Optical (HI510/HI520 Compatible).....	15.66
	Probes, Polarographic.....	6.37
	Probes, Polarographic (with Protective Sleeve).....	6.38
	Probes, Standard.....	6.40
	Solutions.....	6.36-6.40
	Spectrophotometer (iris).....	10.8
<b>Oxygen Scavengers</b>	Photometer, Benchtop (Boilers and Cooling Towers).....	10.34
	Photometer, Benchtop (COD, Water and Wastewater).....	11.6
	Photometer, Benchtop (Lab).....	10.28
	Spectrophotometer (iris).....	10.8
<b>Ozone</b>	Chemical Test Kits.....	9.27
	Photometer, Benchtop (COD, Water and Wastewater).....	11.6
	Photometer, Benchtop (Lab).....	10.28
	Photometer, Benchtop (Pools and Spas).....	10.44
	Spectrophotometer (iris).....	10.8
<b>Paper</b>	HALO2, pH (Leather & Paper).....	2.48
	Portable (HI99 Series).....	2.124
<b>Peroxide Value</b>	Portable, Photometers (Olive Oil).....	10.120
<b>pH</b>	Analyzer (PCA Series).....	15.10
	Benchtop, Advanced pH/ORP.....	2.8
	Benchtop (Built-in Printer).....	2.24
	Benchtop (edge®blu).....	2.34
	Benchtop (edge®pH).....	2.30
	Benchtop (edge®pH•EC•DO).....	2.26
	Benchtop (Research Grade, Multi).....	7.10
	Benchtop (Research Grade, Multi).....	7.4
	Benchtop (Research Grade).....	2.18, 2.22
	Checker®HC (Marine Line).....	10.147
	Checker®HC (Pool Line).....	10.148
	Cheese, Semisolids.....	2.128
	Chemical Test Kits (Quick Soil).....	9.31
	Chemical Test Kits (Soil).....	9.31
	Controller (Pool and Spas).....	15.16, 15.26
	Controller and Dosing Pump (Pool Line).....	15.40
	Controller, Mini.....	15.80
	Controller, Mini (Recorder Output).....	15.81
	Controller, Panel-Mount (Analog).....	15.71
	Controller, Panel-Mount (Analog, Dual-Output).....	15.72
	Controllers, Universal Process.....	15.48
	Controller/Pump (BlackStone).....	15.98
	Dosing System, pH.....	15.32
	Electrodes, AmpHel.....	15.119
	Electrodes, Easy.....	15.124
	Electrodes, Flat-Tip Industrial.....	15.114
	Electrodes, Flat-Tip Industrial (AmpHel).....	15.116
	Electrodes, Flow-Thru.....	15.120-15.122
	Electrodes, In-line.....	15.127
	Electrodes, Industrial.....	15.127
	Electrodes, pH and ORP Half-Cells.....	2.171
	Electrodes, pH and ORP, Digital.....	2.161-2.163
	Electrodes, pH and ORP, Extension Cables.....	2.170
	Electrodes, pH and ORP, Foodcare.....	2.164-2.167
	Electrodes, pH and ORP, Rugged.....	2.160
	Electrodes, pH and ORP, Special.....	2.158

Electrodes, pH and ORP, Specific Analysis.....	2.168-2.170
Electrodes, pH Combination .....	2.154-2.157
Electrodes, Reference.....	2.172-2.173
Electrodes, Submersible.....	15.127
Electrodes, T-Type.....	15.125
Electrodes, Testers .....	1.68
Fertigation Control System.....	15.6
HALO, pH (Brewing).....	2.69
HALO, pH (Field).....	2.64
HALO, pH (Flat Surfaces).....	2.72
HALO, pH (Food).....	2.65, 2.73
HALO, pH (Lab).....	2.60
HALO, pH (Lab, edge@blu).....	2.61
HALO, pH (Lab, Small Samples).....	2.63
HALO, pH (Soil, Direct).....	2.71
HALO, pH (Test Tubes).....	2.62
HALO, pH (Wine, Must, Juice).....	2.67
HALO2, pH (Beer).....	2.49
HALO2, pH (Bread & Dough).....	2.57
HALO2, pH (Cheese).....	2.53
HALO2, pH (Cosmetic Creams).....	2.46
HALO2, pH (Chocolate).....	2.55
HALO2, pH (Field).....	2.44
HALO2, pH (Lab, General Purpose).....	2.42, 2.43
HALO2, pH (Leather & Paper).....	2.48
HALO2, pH (Meat).....	2.54
HALO2, pH (Milk).....	2.52
HALO2, pH (Skin & Scalp).....	2.47
HALO2, pH (Soil).....	2.45
HALO2, pH (Sushi).....	2.51
HALO2, pH (Wine, Must, Juice).....	2.50
Indicator, Panel-Mount (Analog).....	15.70
Monitor (GroLine, In-line).....	1.54
Monitor (GroLine).....	1.58
Monitor (Marine Line).....	1.62
Multiparameter, Portable (HI98194).....	7.34
Multiparameter, Portable (HI98195).....	7.38
Multiparameter, Portable (HI98196).....	7.46
Multiparameter, Portable (HI98494).....	7.28
Multiparameter, Portable (Pool Line, HI981954).....	7.42
Photometer, Benchtop (Aquaculture).....	10.32
Photometer, Benchtop (Environmental).....	10.36
Photometer, Benchtop (Pools and Spas).....	10.44
Photometer, Benchtop (Water Conditioning).....	10.46
Photometer, Benchtop, (Boilers and Cooling Towers).....	10.34
Photometer, Benchtop, (COD, Water and Wastewater).....	11.6
Photometer, Benchtop, (Lab).....	10.28
Photometer, Portable (HI97 Series, Multi).....	10.88, 10.92
(Marine Master), 10.94, 10.88, 10.98, 10.101, 10.102, 10.110.....	
Portable (Analog).....	2.138
Portable (CAL Check™, Multiparameter).....	7.54
Portable (General Purpose).....	2.137
Portable (GroLine, Multiparameter).....	7.52
Portable (HI98 Series, Beer).....	2.106
Portable (HI98 Series, Foodcare Cheese).....	2.102
Portable (HI98 Series, Foodcare, General).....	2.86
Portable (HI98 Series, Foodcare, Meat).....	2.94
Portable (HI98 Series, Foodcare, Milk).....	2.90
Portable (HI98 Series, GroLine Soil).....	2.114
Portable (HI98199, pH, EC, DO).....	2.78
Portable (HI9829, Multiparameter).....	7.14
Portable (HI99 Series, Boiler and Cooling Towers).....	2.123
Portable (HI99 Series, Direct Soil).....	2.121
Portable (HI99 Series, Foodcare Beer).....	2.132-2.133
Portable (HI99 Series, Foodcare Cheese).....	2.127
Portable (HI99 Series, Foodcare Drinking Water).....	2.130
Portable (HI99 Series, Foodcare Meat).....	2.129
Portable (HI99 Series, Foodcare Milk).....	2.125
Portable (HI99 Series, Foodcare Wine).....	2.134
Portable (HI99 Series, Foodcare Yogurt).....	2.126
Portable (HI99 Series, Leather and Paper).....	2.124
Portable (HI99 Series, Multiparameter).....	7.50
Portable (HI99 Series, Plating Baths).....	2.122
Portable (HI99 Series, Skin and Scalp).....	2.136
Portable (HI99 Series).....	2.120
Portable (Multiparameter).....	7.46
Portable (Pool Line Multiparameter).....	7.42
Portable (Pool Line Waterproof, Rugged).....	3.20
Portable (Waterproof, Rugged).....	3.16
Portable (Waterproof, Rugged) (HI98190).....	2.82
Portable, (HI98 Series, Wine).....	2.110
Portable, (HI98 Series, Yogurt).....	2.98
Probe (HI510/HI520 Compatible).....	15.58, 15.60, 15.61
Simulator, Precision, Portable.....	2.139
Solutions, Calibration (GroLine).....	2.181
Solutions, Calibration (Millesimal (±0.002)).....	2.180
Solutions, Calibration (Standard).....	2.182-2.185
Solutions, Calibration (Technical).....	2.188
Spectrophotometer (iris).....	10.8
Testers (Checker®, Checker®Plus).....	1.20
Testers (Combo ORP).....	1.34
Testers (Combo).....	1.8
Testers (Foodcare, Beer).....	1.32
Testers (Foodcare, Bread and Dough).....	1.29
Testers (Foodcare, Cheese).....	1.26
Testers (Foodcare, Chocolate).....	1.30
Testers (Foodcare, Meat).....	1.28
Testers (Foodcare, Milk).....	1.25
Testers (Foodcare, Skin and Scalp).....	1.33
Testers (Foodcare, Sushi).....	1.27
Testers (Foodcare, Wine).....	1.31
Testers (GroLine Combo).....	1.10
Testers (GroLine Soil).....	1.24
Testers (GroLine).....	1.19, 1.23,
Testers (pHep®, pHep®+).....	1.17
Testers (pHep®4, pHep®5).....	1.14
Testers (Pool Line Combo ORP).....	1.36
Testers (Pool Line Combo).....	1.12
Testers (Pool Line).....	1.16, 1.18, 1.22
Titration, Benchtop, Formol Number (Wines and Fruit Juices).....	4.50
Titration, Benchtop, Sulfur Dioxide (Wine).....	4.52
Titration, Benchtop, Titratable Acidity (Dairy).....	4.46
Titration, Benchtop, Titratable Acidity (Fruit Juice).....	4.48
Titration, Benchtop, Total Acidity (Vinegar).....	4.40
Titration, Benchtop, Total Acidity (Water).....	4.42
Titration, Benchtop, Total Acidity (Wine).....	4.54
Titration, Benchtop, Total Titratable Alkalinity.....	4.44
Transmitter.....	15.101-15.103
Turbidity, Portable (EPA, Multi).....	12.16
<b>pH mV</b>	
Benchtop (edge@blu).....	2.34
Benchtop (edge@pH).....	2.30
Benchtop (edge@pH•EC•DO).....	2.26
Portable (HI99 Series).....	2.120
<b>Phosphate</b>	
Checker®HC.....	10.149
Checker®HC (Marine Line).....	10.149
Checker®HC (Pool Line).....	10.149
Chemical Test Kits (Checker®Disc).....	9.28
Chemical Test Kits (Color Cube).....	9.27
Photometer, Benchtop (Aquaculture).....	10.32
Photometer, Benchtop (Boilers and Cooling Towers).....	10.34
Photometer, Benchtop (COD, Water and Wastewater).....	11.6
Photometer, Benchtop (Environmental).....	10.36
Photometer, Benchtop (Lab).....	10.28
Photometer, Benchtop (Nutrient Analysis).....	10.38
Photometer, Benchtop (Pools and Spas).....	10.44
Photometer, Benchtop (Water Conditioning).....	10.46
Photometer, Portable (HI97 Series).....	10.81
<b>Phosphate, Marine</b>	
Photometer, Benchtop (Aquaculture).....	10.32
Photometer, Benchtop (COD, Water and Wastewater).....	11.6
Photometer, Benchtop (Lab).....	10.28
Photometer, Portable, (HI97 Series, Multi, Marine Master).....	10.88, 10.92
<b>Phosphorus</b>	
Checker®HC.....	10.150
Checker®HC (Marine Line).....	10.150
Chemical Test Kits (Quick Soil).....	9.31
Chemical Test Kits (Soil).....	9.31
Photometer, Benchtop (COD, Barcode Recognition).....	11.4
Photometer, Benchtop (COD, Wastewater).....	11.14
Photometer, Benchtop (COD, Water and Wastewater).....	11.6
Photometer, Portable, (HI97 Series).....	10.82
Spectrophotometer (iris).....	10.8
<b>Plating Baths</b>	
Portable, pH (HI99 Series).....	2.122
<b>°Plato</b>	
Refractometer.....	13.7
<b>Pools and Spas</b>	
Chemical Test Kits (Quick-Check).....	9.36
Photometer, Benchtop (Pools and Spas).....	10.44
<b>Pool Line</b>	
Controller and Dosing Pump, ORP (Pool Line).....	15.44
Controller and Dosing Pump, pH (Pool Line).....	15.40
Testers, pH (Pool Line).....	1.16, 1.18, 1.22
Testers, Combo (Pool Line).....	1.12
Testers, EC (Pool Line).....	1.42
Testers, ORP Combo, ORP (Pool Line).....	1.36
Testers, TDS (Pool Line).....	1.42, 1.46
Testers, Temperature (Pool Line).....	1.52
Portable (Pool Line Waterproof, Rugged).....	3.20
Solutions, Cleaning.....	2.189
Solutions, EC.....	5.39
Solutions, Kit.....	15.25
Solutions, ORP.....	2.186
Solutions, pH.....	2.182-2.183
Solutions, Storage.....	2.187
Checker®HC, Alkalinity.....	10.123
Checker®HC, Chlorine, Free.....	10.129
Checker®HC, Copper.....	10.135
Checker®HC, Iron.....	10.140
Checker®HC (pH).....	10.148
Checker®HC (Phosphate LR).....	10.149
Photometer, Portable, (HI97 Series).....	10.96
Portable, Thermo-Hygrometer.....	14.45
Refractometer, Liquid Chlorine.....	13.6
<b>Potassium</b>	
Chemical Test Kits (Quick Soil).....	9.31
Chemical Test Kits (Soil).....	9.31
Electrodes, ISE.....	3.26
Photometer, Benchtop (COD, Water and Wastewater).....	11.6
Photometer, Benchtop (Lab).....	10.28
Photometer, Benchtop (Nutrient Analysis).....	10.38
Photometer, Portable, (HI97 Series).....	10.83
Spectrophotometer (iris).....	10.8
<b>Potential Alcohol</b>	
Refractometer (Wine).....	13.8
<b>Pressure, Atmospheric</b>	
Multiparameter, Portable (HI98494).....	7.28
Multiparameter, Portable (HI98194).....	7.34
Multiparameter, Portable (HI98196).....	7.46
Portable (HI98199, pH, EC, DO).....	2.78
Portable (HI9829, Multiparameter).....	7.14



**Probes (see also Electrodes and Sensors)**

Accessories, Short Probe Cap (HI9829 Probe).....	7.18
Accessories, Long Probe Cap (HI9829 Probe).....	7.19
Accessories, Flow Cell (HI9829 Probe).....	7.19
DO, Digital (edge® Compatible).....	6.36
DO, Galvanic.....	6.39
DO, Galvanic (HI510/HI520 Compatible).....	15.64
DO, Optical.....	6.34
DO, Optical (HI510 HI510/HI520 Compatible).....	15.66
DO, Polarographic.....	6.37
DO, Polarographic (with Protective Sleeve).....	6.38
DO, Standard.....	6.40
EC (HI510 HI510/HI520 compatible).....	15.62
EC, Flow-thru.....	15.129
EC, In-line.....	15.128
EC, Submersion.....	15.129
Multiparameter, HI9829 Compatible.....	7.17-7.19
Multiparameter, Replacement.....	7.58
ORP (HI510 HI510/HI520 compatible).....	15.57
pH (HI510/HI520 compatible).....	15.58, 15.60, 15.61
Temperature, Calibration Keys (Thermistor).....	14.21
Temperature, Industrial (Stainless Steel, Flow-thru, Immersion).....	15.130
Temperature, Thermistor.....	14.21-14.22
Temperature, Thermistor (Foodcare).....	14.29
Temperature, Thermocouple (K-Type).....	14.11-14.19
Temperature, Thermocouple (K-Type, Foodcare).....	14.35-14.38
Temperature, Thermocouple (T-Type, Foodcare).....	14.39-14.41

**Reagents**

Checker®HC.....	10.152
Chemical Test Kits.....	9.44-9.46
COD (Certified Standards and Reagents).....	11.22
COD (HI83224).....	11.5
Photometer, CAL Check™.....	10.115
Photometer, Standard.....	10.114

**Reducing Sugars**

Photometer, Portable (Wine, Reducing Sugars).....	10.116
--	--------

**Relative Humidity**

Thermo-Hygrometer, Portable.....	14.45
----------------------------------	-------

**Resistivity**

Benchtop, Advanced Conductivity/Resistivity/ TDS/Salinity.....	5.6
Benchtop (Research Grade).....	5.16
Benchtop (Research Grade, Multi).....	7.4
Benchtop (Research Grade, Multi).....	7.10
Controller, Mini.....	15.91
Multiparameter, Portable (HI98494).....	7.28
Multiparameter, Portable (HI98194).....	7.34
Multiparameter, Portable (HI98195).....	7.38
Multiparameter, Portable (Pool Line, HI981954).....	7.42
Portable (HI98199, pH, EC, DO).....	2.78
Portable (HI9829, Multiparameter).....	7.14
Portable (Waterproof, Rugged).....	5.26
Portable (Ultrapure Water).....	5.29

**Salinity**

Benchtop, Advanced Conductivity/Resistivity/ TDS/Salinity.....	5.6
Benchtop (edge®pH•EC•DO).....	5.18
Benchtop (edge®EC).....	5.22
Benchtop (Research Grade).....	5.16
Benchtop (Research Grade, Multi).....	7.4, 7.10
Chemical Test Kits.....	9.28
Multiparameter, Portable (HI98494).....	7.28
Multiparameter, Portable (HI98194).....	7.34
Multiparameter, Portable (HI98195).....	7.38
Multiparameter, Portable (Pool Line, HI981954).....	7.42
Monitor (Marine Line).....	1.62
Portable (HI9829, Multiparameter).....	7.14
Portable (HI98199, pH, EC, DO).....	2.78

Portable, Refractometer (Aquaculture).....	13.12
Portable (Ultrapure Water).....	5.29
Portable (Waterproof, Rugged).....	5.26
Solutions, Calibration (Seawater).....	5.42
Testers (Marine Line).....	1.37
Testers, (Groline).....	1.38
Testers, DIST 9.....	1.39

**Salt Content**

Solutions, Cleaning, pH and ORP Electrode (Industrial Processes).....	2.189
--	-------

**Scalp**

HALO2, pH (Skin & Scalp).....	2.47
Portable, pH (HI99 Series).....	2.136
Testers, pH.....	1.33

**Seawater**

Multiparameter, Portable (HI98494).....	7.28
Multiparameter, Portable (HI98194).....	7.34
Multiparameter, Portable (HI98195).....	7.38
Multiparameter, Portable (Pool Line, HI981954).....	7.42
Portable, Multi (HI9829).....	7.14
Portable (HI98199, pH, EC, DO).....	2.78

**Sebum**

Solutions, Cleaning, pH and ORP Electrode.....	2.189
--	-------

**Sensors**

Conductivity (HI9829).....	7.17-7.19
Conductivity and Turbidity (HI9829).....	7.18-7.19
DO (HI9829).....	7.18-7.19
DO (HI98494, Optical).....	7.31
DO (HI98194, HI98196).....	7.36
EC (HI98194, HI981954, HI98195).....	7.36
ISE (HI9829).....	7.18-7.19
pH (HI98194, HI981954, HI98196, HI98195).....	7.36
pH (HI9829).....	7.18-7.19
pH/ORP (HI98194, HI981954, HI98196, HI98195).....	7.36

**Silica**

Checker®HC.....	10.151
Chemical Test Kits (HR).....	9.29
Photometer, Benchtop (Boilers and Cooling Towers).....	10.34
Photometer, Benchtop (COD, Water and Wastewater).....	11.6
Photometer, Benchtop (Environmental).....	10.36
Photometer, Benchtop (Lab).....	10.28
Photometer, Benchtop (Water Conditioning).....	10.46
Photometer, Portable, (HI97 Series).....	10.84
Spectrophotometer (iris).....	10.8

**Silver**

Photometer, Benchtop (COD, Water and Wastewater).....	11.6
Photometer, Benchtop (Lab).....	10.28
Photometer, Benchtop (Water Conditioning).....	10.46
Photometer, Portable, (HI97 Series).....	10.85
Spectrophotometer (iris).....	10.8

**Silver/Sulfide**

Electrodes, ISE.....	3.27
----------------------	------

**Simulator**

Portable (pH Precision).....	2.139
BL121 specific.....	15.31

**Skin**

HALO2, pH (Skin & Scalp).....	2.47
Portable, pH (HI99 Series).....	2.136
Solutions, Cleaning, pH and ORP Electrode.....	2.189
Testers, pH.....	1.33

**Sodium**

Electrodes, ISE.....	3.27
Refractometer (Food).....	13.10

**Soil Analysis**

Chemical Test Kits (Backpack Lab®).....	9.40
Chemical Test Kits (Quick Soil).....	9.31
Chemical Test Kits (Soil).....	9.31
Electrodes (GroLine, Quick Connect).....	2.117
HALO, pH (Soil, Direct).....	2.71
HALO2, pH (Soil).....	2.45
Lysimeter.....	10.40
Portable, pH (GroLine Soil).....	2.114
Portable (HI99 Series, Direct Soil).....	2.121
Solutions, Cleaning, pH and ORP Electrode.....	2.189
Solutions, Sample Preparation.....	2.186
Testers, pH (GroLine Soil).....	1.24
Testers, EC, Direct Soil (GroLine Soil Test).....	1.45

**Solutions**

Cleaning, pH and ORP Electrode (General Purpose).....	2.189
Cleaning, pH and ORP Electrode (GroLine).....	2.189
Cleaning, pH and ORP Electrode (Specific).....	2.189
Calibration, EC.....	5.36-5.40
Calibration, Multiparameter, GroLine (Quick Cal).....	2.181
Calibration, Multiparameter, HI9829 (Quick Cal).....	2.76
Calibration, pH (GroLine Quick Cal).....	2.181
Calibration, pH (Millesimal (±0.002)).....	2.180
Calibration, pH (Standard).....	2.182-2.185
Calibration, pH (Technical).....	2.178
Calibration, TDS.....	5.41
Fill, ISE, Gas Sensor.....	3.28
Fill, ISE, Reference.....	3.29
Fill, pH and ORP Electrode.....	2.190
Kit, Sachets (Pool Line).....	15.25
Ionic Strength Adjusters (ISA), ISE.....	3.29
Sample Preparation, Soil.....	2.186
Sample Preparation, Solids and Semi-Solids.....	2.186
Specific, ISE.....	3.28
Standards, ISE, Fluoride.....	3.30
Standards, ISE, Sodium Chloride.....	3.30
Standards, ISE, Sodium.....	3.30
Standards, ISE.....	3.28
Storage, pH and ORP Electrode.....	2.187
Test and Pretreatment, ORP.....	2.186

**Stirring**

Compact Stirrers.....	8.8
Compact Stirrers (with Built-in Electrode Holder).....	8.6
Heavy-Duty Stirrers.....	8.4
Standard Stirrers.....	8.3

**Sugar Analysis**

Refractometer (Wine).....	13.8
Refractometer (Wort).....	13.7
Refractometer (Food).....	13.3

**Sulfate**

Chemical Test Kits.....	9.29
Chemical Test Kits (LR, HR).....	9.30
Electrodes, ISE.....	3.26
Photometer, Benchtop, (COD, Water and Wastewater).....	11.6
Photometer, Benchtop, (Lab).....	10.28
Photometer, Benchtop, (Nutrient Analysis).....	10.38
Photometer, Portable, (HI97 Series).....	10.86

**Sulfite**

Chemical Test Kits.....	9.30
-------------------------	------

**Surfactants, Anionic**

Photometer, Benchtop (Lab).....	10.28
Photometer, Benchtop (COD, Water and Wastewater).....	11.6
Photometer, Portable, (HI97 Series).....	10.56
Spectrophotometer (iris).....	10.8

**Sushi Analysis**

HALO2, pH (Sushi).....	2.51
Testers, pH (Foodcare Sushi).....	1.27

<b>Tartaric Acid</b>		Benchtop (Research Grade).....7.4	Testers, pH (Foodcare Wine).....1.31
Photometer, Portable (Wine, Tartaric Acid).....10.118		Benchtop (Research Grade).....7.10	Titration, Benchtop, Formol Number (Wines and Fruit Juices).....4.50
<b>TDS</b>		Controller, Mini.....15.87-15.89	Titration, Benchtop, Potentiometric Titration Systems (Wine Analysis).....4.36
see <i>Total Dissolved Solids</i>		Dosing System, Nutrient (GroLine).....15.36	Titration, Benchtop, Sulfur Dioxide (Wine).....4.52
<b>Temperature</b>		Monitor (GroLine, In-line).....1.54	Titration, Benchtop, Total Acidity.....4.54
Dataloggers.....14.42-14.43, 14.44		Monitor (GroLine).....1.58	Turbidity, Portable (Bentonite).....12.21
Monitor (Checkfridge).....1.67		Multiparameter, Portable (HI98494).....7.28	
Monitor (Pronto).....1.66		Multiparameter, Portable (HI98194).....7.34	
Portable, Thermistor (Brewing).....14.26		Multiparameter, Portable (HI98195).....7.38	
Portable, Thermistor (Foodcare).....14.28		Multiparameter, Portable (Pool Line, HI981954).....7.42	
Portable, Thermistor.....14.20		Portable (Waterproof, Rugged).....5.26	
Portable, Thermocouple (Foodcare, K-Type Fixed).....14.34		Portable (Ultrapure Water).....5.29	
Portable, Thermocouple (Foodcare, K-Type Ultra Fast).....14.32		Portable (99 Series).....5.33	
Portable, Thermocouple (Foodcare, K-Type).....14.30		Portable (Manual Calibration).....5.35	
Portable, Thermocouple (Foodcare, T-Type Ultra Fast).....14.33		Portable (HI9829, Multiparameter).....7.14	
Portable, Thermocouple (K-Type, Dual-Channel).....14.8		Portable (99 Series, Multiparameter).....7.50	
Portable, Thermocouple (K-Type, Meter Only).....14.10		Portable (HI98199, pH, EC, DO).....2.78	
Portable, Thermocouple (K-Type).....14.7		Portable (GroLine, Multiparameter).....7.52	
Probe, Industrial.....15.130		Portable (Pool Line Multiparameter).....7.42	
Probes, Calibration Keys (Thermistor).....14.21		Portable (CAL Check™, Multiparameter).....7.54	
Probes, Thermistor (Foodcare).....14.29		Portable (Multiparameter).....7.56	
Probes, Thermistor.....14.21-14.22		Solutions, Calibration.....5.41	
Probes, Thermocouple (Foodcare, K-Type).....14.35-14.38		Testers (Combo).....1.8	
Probes, Thermocouple (Foodcare, T-Type).....14.39-14.41		Testers (DiST®1, DiST®2).....1.44	
Probes, Thermocouple (K-Type).....14.11-14.19		Testers (DiST®5, DiST®6).....1.40	
T-Logger.....14.45		Testers (GroLine).....1.45	
Testers (Checktemp®).....1.50		Testers (GroLine Combo).....1.10	
Testers (Checktemp®1).....1.51		Testers (Pool Line Combo).....1.12	
Testers (Checktemp®4).....1.48		Testers (Pool Line).....1.42, 1.46	
Testers (Checktemp®Dip).....1.52			
Testers (Pool Line).....1.52			
Testers (T-Shaped).....1.53			
<b>Titration</b>		<b>Turbidity</b>	
Accessories and Reagents, Meter Specific.....4.57-4.62		Benchtop (EPA, Multi).....12.6	
Autosampler, Benchtop.....4.12		Benchtop (EPA).....12.10	
Electrodes, Photometric.....4.30		Benchtop (ISO).....12.18	
Solutions and Reagents.....4.56		Portable (Beer Haze, FastTracker™).....12.22	
Titration, Benchtop, Formol Number (Wines and Fruit Juices).....4.50		Portable (Bentonite, FastTracker™).....12.21	
Titration, Benchtop, Karl Fischer Coulometric.....4.26		Portable (EPA, Multi, FastTracker™).....12.12	
Titration, Benchtop, Karl Fischer Volumetric.....4.22		Portable (EPA, FastTracker™).....12.14	
Titration, Benchtop, Potentiometric Titration Systems.....4.6, 4.16,		Portable (EPA, Multi).....12.16	
Titration, Benchtop, Potentiometric Titration Systems (Wine Analysis).....4.36		Portable (HI9829, Multiparameter).....7.14	
Titration, Benchtop, Sulfur Dioxide (Wine).....4.52		Portable (ISO).....12.20	
Titration, Benchtop, Total Titratable Acidity.....4.42		Portable (ISO, FastTracker™).....12.17	
Titration, Benchtop, Total Titratable Alkalinity.....4.44		Standards.....12.24-12.26	
Titration, Benchtop, Titratable Acidity (Dairy).....4.46			
Titration, Benchtop, Titratable Acidity (Fruit Juice).....4.48		<b>Vinegar</b>	
Titration, Benchtop, Total Acidity (Vinegar).....4.40		Titration, Benchtop, Total Acidity.....4.40	
Titration, Benchtop, Total Acidity (Wine).....4.54			
<b>Total Dissolved Solids (TDS)</b>		<b>Water, Pure/Ultrapure</b>	
Benchtop, Advanced Conductivity/Resistivity/TDS/Salinity.....5.6		Portable (Ultrapure Water).....5.29	
Benchtop (edge®pH•EC•DO).....2.26		Testers (PWT).....1.47	
Benchtop (edge®EC).....5.22		Testers (UPW).....1.47	
Benchtop (Research Grade).....5.16		<b>Water Conditioning</b>	
		Photometer, Benchtop, (Water Conditioning).....10.46	
		<b>Water, Drinking</b>	
		pH, Electrodes (Foodcare, Quick Connect).....2.131	
		pH, Portable (99 Series, Foodcare Drinking Water).....2.130	
		<b>Water Quality</b>	
		Chemical Test Kits.....9.37	
		Chemical Test Kits (Backpack Lab®).....9.38	
		<b>Wine Analysis</b>	
		Electrodes, pH (Foodcare, Quick Connect).....2.113, 2.135	
		HALO, pH (Wine, Must, Juice).....2.67	
		HALO2, pH (Wine, Must, Juice).....2.50	
		Photometer, Portable (Wine, Reducing Sugars).....10.116	
		Photometer, Portable (Wine, Tartaric Acid).....10.118	
		Portable, pH (HI99 Series, Foodcare).....2.134	
		Refractometer (Wine).....13.8	
		Solutions, Cleaning, pH and ORP Electrode (Wine Deposits).....2.189	
		Solutions, Cleaning, pH and ORP Electrode (Wine Stains).....2.189	
		<b>Yeast Available Nitrogen (YAN)</b>	
		Solutions, Titration.....4.39	
		<b>Yogurt Analysis</b>	
		Electrodes, pH (Foodcare, Quick Connect).....2.101	
		Portable, pH (Foodcare).....2.98	
		Portable, pH (HI99 Series, Foodcare).....2.126	
		Portable, pH (HI99 Series, Foodcare, Yogurt, Cheese, Semisolids).....2.128	
		Solutions, Cleaning, pH and ORP Electrode.....2.189	
		<b>Zinc</b>	
		Photometer, Benchtop (Boilers and Cooling Towers).....10.34	
		Photometer, Benchtop (COD, Water and Wastewater).....11.6	
		Photometer, Benchtop (Environmental).....10.36	
		Photometer, Benchtop (Lab).....10.28	
		Photometer, Benchtop (Water Conditioning).....10.46	
		Photometer, Portable, (HI97 Series).....10.87	
		Spectrophotometer (iris).....10.8	

# Limited Warranty, Return and Exchange

## Limited Warranty

Hanna products are manufactured in our ISO 9001:2008 facilities, meeting the highest quality standards in the industry. Hanna's high standards also apply should a product be returned due to defects in material or workmanship. Our extensive warranty extends up to five years on some products.

**Limitations: Warranted products may be returned for repair or replacement only at the discretion of Hanna. In some circumstances, remedy may constitute refund for the price paid for the product.**

The warranty period commences from the original date of sale to the user or a maximum of 18 months from factory ship date. Warranty is valid only when the product is used under normal conditions and in accordance with operating limitations and prescribed maintenance procedures. The express warranty stated previously is the only express warranty given by Hanna to the end-user buyer. Hanna expressly disclaims any warranties implied by law, including but not limited to warranty of merchantability or fitness for a particular purpose. Hanna shall not be liable for any individual or consequential damages of any kind for breach of any warranty, negligence, on the basis of strict liability or otherwise. Hanna's warranty periods differ across our range of instrumentation, please visit us on the web at: [www.hannainst.com](http://www.hannainst.com) or contact your local Hanna representative for specific warranty information.

## Instrument Service:

Warranty and non-warranty service, replacement, recalibration and repairs are performed by factory trained service technicians at one of Hanna's Technical Service Centers worldwide. All items must have a Return Goods Authorization (RGA) number that can be obtained by contacting the Hanna Technical Service Department. The RGA number should be clearly marked on the outside of the box and the unit shipped prepaid and insured. Any product not bearing an RGA number will be refused. All products returned for warranty repair or replacement MUST be preceded or accompanied with proof of purchase, such as the original invoice or packing slip. Under special circumstances it may be deemed necessary by Hanna to issue a Return In Advance (RIA). In such cases, the defective materials must be returned to Hanna within 30 days. Materials not returned within 30 days become chargeable. Materials must be packed properly to avoid damage during transport, which would render the warranty null and void. The sender is responsible for expediting any damage claims placed against the carrier.

In most cases, a flat minimum service charge applies to non-warranty repairs or recalibration. Please contact your local Hanna Technical Service Department for current rates. Any materials returned for repair which are considered non-warranty may be serviced at hourly cost (excluding parts) following subsequent notification and approval of such.

## Product Return and Exchange

### Returning Merchandise:

Should an instance occur when a product may need to be returned for exchange or credit, or should a discrepancy occur in a packing slip, Hanna must be contacted to obtain a Return Goods Authorization Number (RGA). Please follow these steps:

1. Within 30 days of receipt of merchandise call Hanna's Technical Service Department to obtain a Return Goods Authorization Number.
2. Hanna will issue a Return Goods Authorization Number.
3. The number must be clearly marked on the outside of the package being returned. Shipments not bearing a Return Goods Authorization Number will be refused.
4. Credit returns may be subject to a 25% restocking fee.

### Terms and Conditions

Return shipments must meet the following requirements to be accepted for credit:

1. Products must be returned in the original packaging with labeling not defaced. All items returned will be inspected for credit worthiness. Credit will only be issued for product returned in like-new condition. No credit will be issued for product, which is not received in like-new condition.
2. All freight charges are the responsibility of the customer.
3. All chemicals and reagents being returned must be packaged in accordance with the laws and regulations of the governing country. Only unopened chemicals and reagents may be returned.



